

Notice regarding specifications

I.U. = Indoor Unit O.U. = Outdoor Unit Qu = Quiet * = Not decided yet

- Specifications and design are subject to change without notice for future improvement.
- For further details, check with our authorized dealers.
- Cooling and heating capacities are based on the following conditions:

Cooling	Indoor temp.: 27°C DB/19°C WB Outdoor temp.: 35°C DB/24°C WB	Heating	Indoor temp.: 20°C DB Outdoor temp.: 7°C DB/6°C WB
---------	---	---------	---

- Performance tests are conducted in accordance with EN14511.
- Seasonal efficiency tests are conducted in accordance with EN14825.
- Sound power tests are conducted in accordance with EN12102.



Fujitsu General (Thailand) Co., Ltd.



ISO 9001 Certification number: 01 100 075229
ISO 14001 Certification number: 01 104 9245

Fujitsu General (Shanghai) Co., Ltd.



ISO 9001 Certification number: 01 100 79269
ISO 14001 Certification number: CNBJ312244-UK

Fujitsu General Central Air-conditioner (Wuxi) Co., Ltd.



ISO 9001 Certification number: 15917020073R5M
ISO 14001 Certification number: 15918E20021R5M

- The products and equipment listed in this catalog contain fluorinated greenhouse gases.
- **OGENERAL** and **AIRSTAGE** are worldwide trademarks of Fujitsu General Limited, and are registered trademarks in Japan and other countries and regions.
- iPhone and iPod touch are trademarks of Apple Inc., registered in the United States and other countries.
- "Microsoft," "Windows," and "DirectX" are trademarks of Microsoft Corporation in the United States and other countries.
- "Intesis" is a registered trademark of HMS Industrial Networks in the European Union and is trademarked in the rest of the world.
- "BACnet" is a trademark and registered trademark of the American Society of Heating, Refrigerating and Air-Conditioning Engineers, Inc.
- "MODBUS" is a registered trademark of Schneider Electric.
- "LONWORKS" and "Echelon" are trademarks of Echelon Corporation registered in the United States and other countries.
- "Adobe" and "Acrobat Reader" are either registered trademarks or trademarks of Adobe in the United States and/or other countries.
- "Android" is a trademark of Google LLC.
- Other company and product names mentioned in this document may be the registered trademarks, trademarks or trade names of their respective owners.
- **PGair** is a worldwide trademark of Fujitsu General Limited.
- "Bluetooth" is a registered trademark of Bluetooth SIG, inc.

Distributed by:

FUJITSU GENERAL LIMITED

3-3-17, Suenaga, Takatsu-ku, Kawasaki, Kanagawa, 213-8502, Japan
www.fujitsu-general.com/g-global/



Copyright© 2008-2024 Fujitsu General Limited. All rights reserved. 3EG037-2312E



PRODUCT CATALOGUE 2024

AIR CONDITIONERS LINEUP

OGENERAL

PRODUCT CATALOGUE 2024

AIR CONDITIONERS LINEUP

FUJITSU GENERAL LIMITED

FUJITSU GENERAL LIMITED

OUR MESSAGE

SOLUTIONS

SPLIT

MULTI-SPLIT

VRF

VENTILATION

CONTROL SYSTEM
& OPTIONAL PARTS

AIR TO WATER

SUPPORT

The FUJITSU GENERAL Way

Our mission

Living together for our future

Through innovation and technology, we deliver a brighter future with peace of mind to our customers and societies around the world.

Our philosophy

Act spontaneously

We embrace new challenges by investing in ourselves for personal growth, and through continuous creativity with a spontaneous attitude.

Develop our team

We respect and value our people, and optimize their abilities through fostering culture and diversity, and utilizing a collaborative effort focused on communication.

Value integrity

To achieve our goals, we always act with integrity and shared ethics.

CONTENTS

004 OUR MESSAGE

- 006 Sustainable
- 008 Cleanliness
- 010 Future
- 012 Comfort
- 014 Control
- 016 Design
- 018 History
- 020 Worldwide locations
- 022 Global business activities
- 024 Project references
- 026 Global development & Production bases
- 028 High-quality development & Production Facilities
- 030 2024 New Products

034 SOLUTIONS

- 036 For Light Commercial Use
- 044 For Commercial Use
- 046 For Apartments & Houses

PRODUCT LINEUP

SPLIT & MULTI-SPLIT

VRF

VENTILATION

CONTROL SYSTEM & OPTIONAL PARTS

AIR TO WATER

SUPPORT

- Sp-002 VRF Support
- Sp-004 HVAC System design Support Tool
- Sp-006 Air To Water Support Tool
- Sp-008 Quick Service & Maintenance
- Sp-010 AIRSTAGE Service Monitor Tool
- Sp-012 Service Tool
- Sp-013 Web monitoring tool

OUR MESSAGE



for Sustainable



for Cleanliness



for Future

**Innovation
and
Globalization**



for Comfort



for Control



for Design

We create comfortable lives for people around the world with "made-in-Japan quality" and innovative manufacturing.

-  History
-  Worldwide locations
-  Global business activities
-  Project references
-  Global development & Production bases
-  High-quality development & Production facilities



Sustainable



Sustainable management

We see the challenge of expanding our business by contributing to the realization of a sustainable society as a core element of our growth strategy, and we are working on "sustainable management," based on the three pillars of "harmonious coexistence with our planet," "social contribution," and "care for employees."

Basic policy on sustainable management

The sustainable development goals (SDGs) of the UN will drive business creation in the coming years. The key principle of the SDGs, "Leave no one behind," is synonymous with our own corporate philosophy of "Living together for our future." The promotion of sustainable management is carried out from a medium- to long-term perspective, with a promise to shape a sustainable society for the children and society of the future. We will pursue business growth by accelerating this transformation.

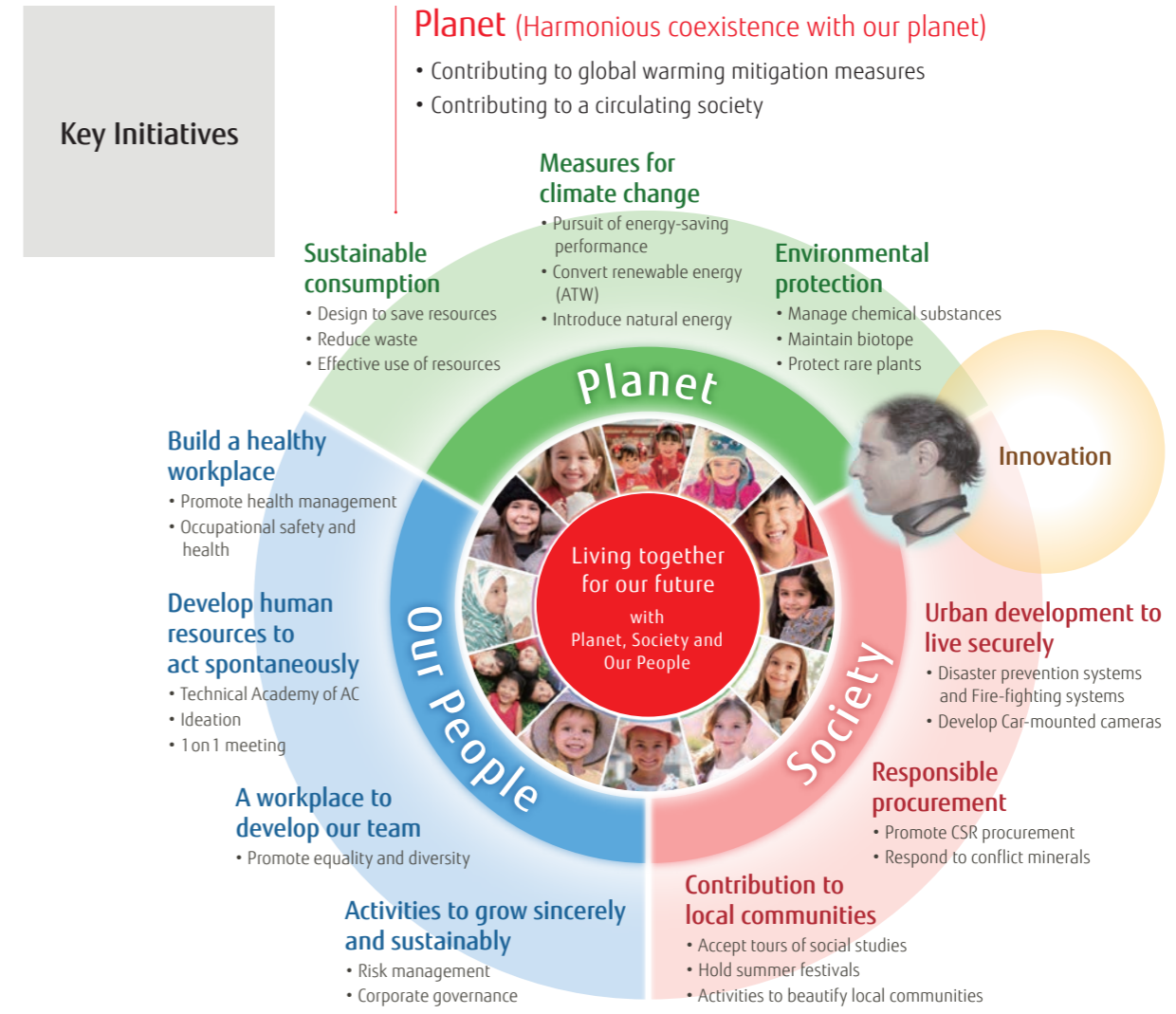

Our People (Care for employees)

- Strategic implementation of health and productivity management
- Creating flexible work styles under COVID-19
- Enhancing human resource development

Society (Social contribution)

Fostering innovation to address social issues (Providing a healthy, clean, and safe society and environment)



Cleanliness



Think about air quality

Fresh air is essential for comfortable air conditioning. Fujitsu General offers a wide range of air conditioning products with air purification functions, such as ventilation systems equipped with high-performance filters and heat exchangers.

Collecting dust particles to clean the air



Silver Ion Filter

The Silver ion filter helps to keep indoor air free from viruses, bacteria and molds. Notice: Not a result of experiments in an actual use environment. Silver ion filter inhibits activity or growth of microorganism, but do not prevent infection.

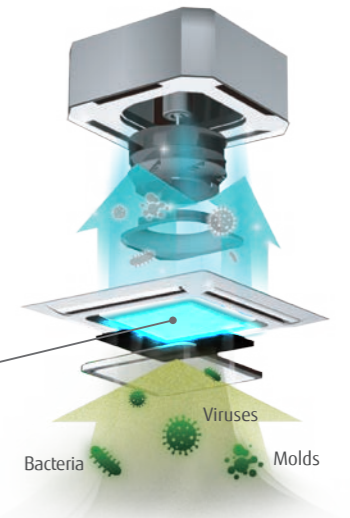
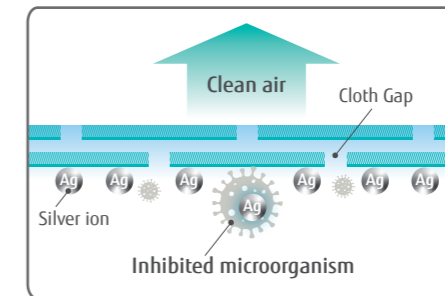

Different filters are used on each side



Ion Deodorization Filter

Deodorizes the air by decomposing absorbed odors using the oxidizing and odor-reducing effects of ions generated by ultra-fine particle ceramic.

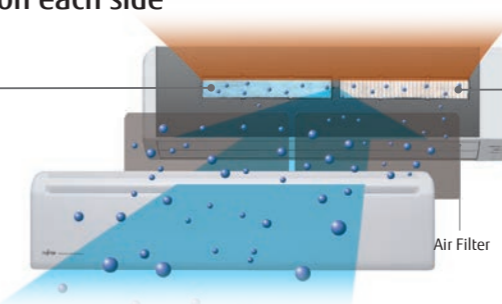
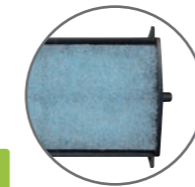

Apple-catechin Filter

The Apple-catechin filter uses static electricity to remove fine particles and dust from the air.

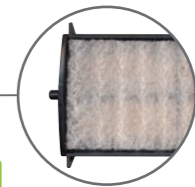

Ventilation with adequate airflow with reduced temperature changes

Heat Exchange Ventilation

When a room is cooled or heated, the exhausted cooling or heating energy is recovered by heat exchange ventilation.



Adopts a high-efficiency counterflow heat exchange element





Future



The green refrigerant

Throughout our research and development process, we are constantly striving to create products that we can be proud of in the future. The technologies we have cultivated through these efforts are incorporated into our environmentally friendly products, and are recognized in the European market, which has extremely strict environmental regulations.

R32 refrigerant with reduced global warming potential

- **Zero** Ozone Depletion Potential (ODP^{*1})
- High environmental properties
- High performance
- Economically efficient

*1 **ODP (Ozone Depleting Potential)**: a relative value that indicates the impact per unit weight of ozone-depleting substances released into the atmosphere when CFC-11 (trichlorofluoromethane, CCl3F) is fixed at 1.0

*2 **GWP (Global Warming Potential)**: a measurement that indicates how much other greenhouse gases are capable of warming the Earth based on carbon dioxide. This is the integrated value of radiant energy given to the Earth (i.e., the estimated impact on global warming) expressed as a ratio to CO₂.

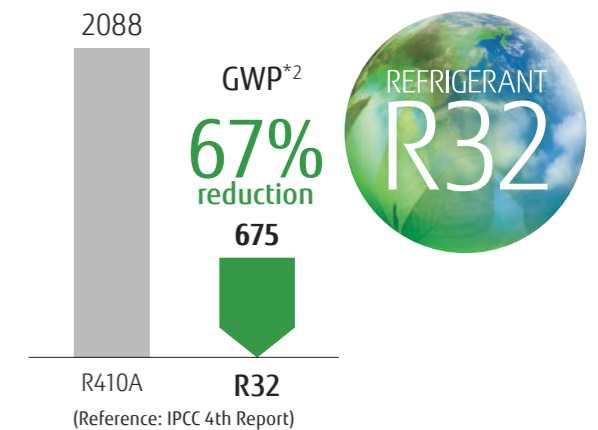

Low GWP to a wide range of projects

We are continuously working to develop products that use R32 refrigerant and have R32 products in all product categories in our lineup (Split, Multi-Split, VRF, and ATW). This allows us to realize environmentally and regulatory friendly system designs for a wide range of projects from residential to light commercial.

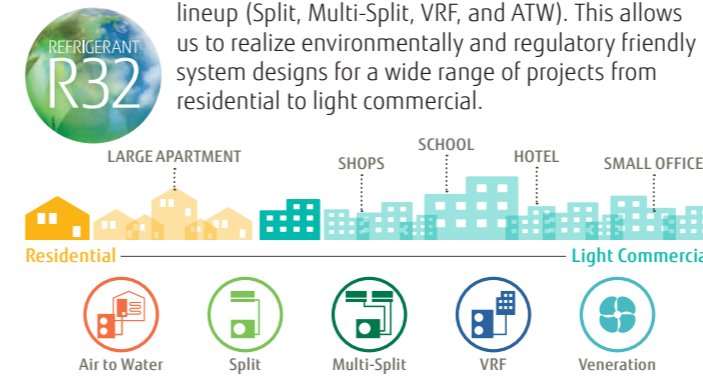

New energy labelling requirement 626/2011/EU

Our air conditioners have reached the "Class A+++" ranking, the highest energy efficiency level that is now shown on energy labels in Europe.

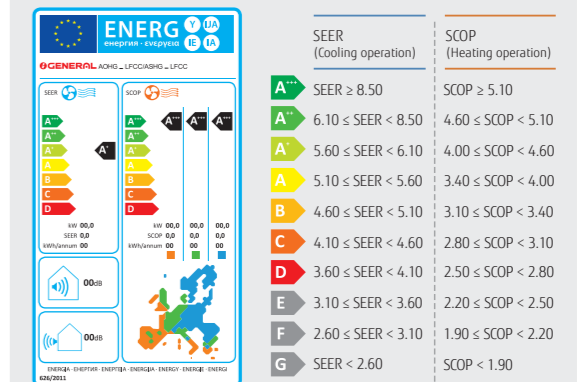

Fujitsu General's Environmental Vision

Medium-Term Environmental Plan: Target and Measure

	Target	Measure
Reduction of Our Own Environmental Impact Achieve	<p>Achieve carbon neutrality by FY2025</p> <p>[Old Target] Greenhouse gas emissions from our Group's business activities: Completely eliminate by FY2030</p>	<ol style="list-style-type: none"> 1. Renewable energy conversion: Existing plants (by FY2023) 2. Renewable energy conversion: All Group companies (by FY2025) → Achieved 1 and 2 ahead of schedule (April 2022) 3. Shift to use of renewable energy for all other energy used (by FY2025)
Through Our Supply Network	Reduction of 30% for total greenhouse gas emissions through our supply Network by FY2035 (vs. FY2018)	<ul style="list-style-type: none"> • Promotion of green electricity use by our suppliers • Reduction of material consumption and product weight
For our Customers and Society	Reduce greenhouse gas emissions from the use of our products. Reduction of 30% by FY2030 (vs. FY2013)	<ul style="list-style-type: none"> • Replace constant-speed A/C with inverter A/C (India and Middle East) • Enhance energy efficiency



Comfort



Comfortable airflow design

Pursuing the potential of air conditioners and true comfort, Fujitsu General has developed and commercialized numerous world-first technologies, and these concepts are reflected in the design of our products.

Cassette type 3D flow Series

3 individually controlled air outlet ports

The Comfortable airflow setting enables the right and left air outlet ports as well as the wide center port to work together to provide a comfortable room environment.

*1: Announced 2018. In room air conditioner for the home (Our company's investigation)

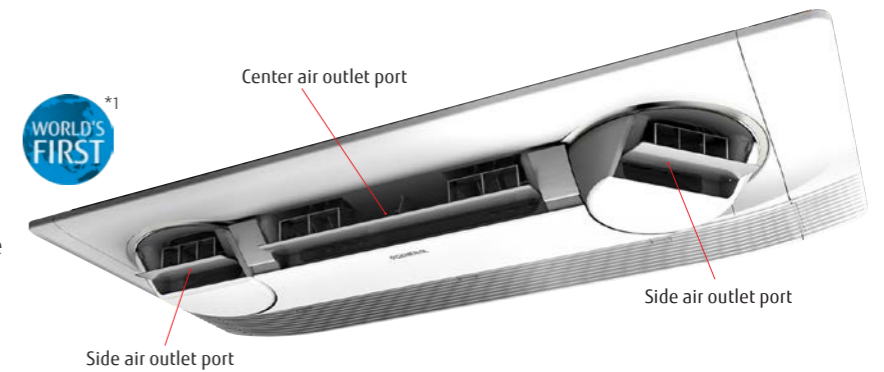

Cassette type One-way flow Series

Wide airflow range created by triangle design and large flap

A large flap with a wide range of movements, equipped with louvers arranged triangularly, sends air into every corner of the room.

Cassette type Circular flow Series

Unique circular flow design

This Series realizes a Circular Flow to blow a large airflow in a 360° direction by using a high-performance DC fan motor, turbo fan, and a unique seamless airflow louver design.

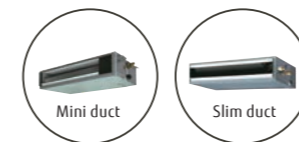

Auto louver grille kit for Mini duct and Slim duct

Flexible Control

The optional clean-looking flat Auto louver grille kit blends into any interior and provides a comfortable airflow.





Control

Operation from anywhere

Using the Internet of Things (IoT), Fujitsu General is actively providing services that allow users to control their air conditioners from their smartphones. We are also expanding our open co-creation activities with external partners to deepen the development of new functions and services using IoT and artificial intelligence (AI) to develop safe and convenient air conditioners.



User-friendly screen display enables easy operation.

With the WLAN adapter and the AIRSTAGE Mobile app, you can control the heating and cooling of your home anytime, anywhere.



Turn on the air conditioner in the living room!

Voice control via smart speaker

Connecting with a smart speaker allows the user to operate the air conditioner and check its operation status just by talking to it.

Software application for WLAN Adapter

"AIRSTAGE Mobile" is a software application that allows users to control Fujitsu General air conditioners from anywhere with a mobile device while out or on the move.

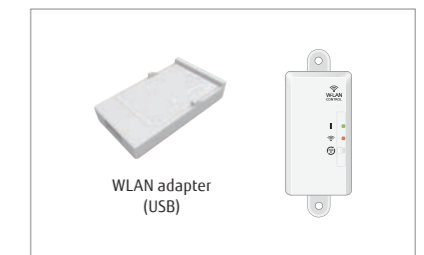

+
**AIRSTAGE
Mobile**

Download Free



Compact wired remote controller

Large screen and simple display

- Large screen, yet compact in size
- Large, easy-to-read letters are used.
- The controls are simple and easy to understand.



Central remote controller for VRF system

The central remote controller uses a touch panel screen to display multiple menus on the top screen. Just touch the menu you want to operate, and the necessary window will pop up, and allow intuitive operation.

Remote monitoring and operation

The central remote controller enables monitoring and control of a tenant's air conditioner anytime, anywhere.

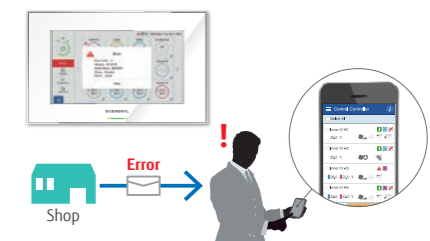



Design

Harmonizes with the installation space

Fujitsu General offers a wide range of products for the European market, including models with unique textural designs, award-winning models that integrate with room interiors, and Cassette type models with different designs that match office spaces. We also have a lineup of models with elegant designs, such as the Ceiling type models with its beautiful curved surface.



Light Elegant Design

New Ceiling type design

The light, elegant and three-dimensional expression achieved by the curved surface gives a sense of comfort and well-being.



NEW KN Series KL Series

New "Elegant & Smart" Square Design

New Wall-mounted type design

Smart design with ridges and subtle shade
*Image is KN Series

NEW

Sleek and Stylish Design

New designed wired remote controller

When not in use, the controller is a part of the interior decor. This is achieved by using mirrors, glass, and clear panel, and it appears to be on with the wall.



NEW

Stylish design

New outdoor unit for Air to Water **Future Release**

A design that offers a sophisticated style that is quiet and blends in with the outdoor landscape.





History

Yaou Shoten Ltd. established in 1936

Overseas air conditioning business since 1971

Starts air conditioning business in Japan in 1960

1971 Air conditioner exports to the Middle East.

1977 "Super Power, Super Quiet" Series released

1982 Window type 3 Super Series released



AL/AX Series

1985 Large wall-mounted type and multi-split air conditioner released.

***1,*2 1991** World's first air conditioner equipped with lambda-shaped heat exchanger

1994 World's first air conditioner with power diffuser

2001 AIRSTAGE Series released VRF air conditioners for large buildings



***3 2002** Air conditioner with the world's first automatic self-cleaning filter system

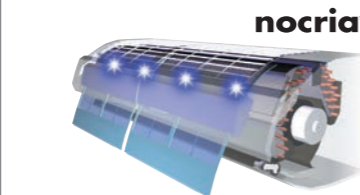

2004 Standalone Compact VRF AIRSTAGE J Series released



2006 VRF Heat Pump type Maximum 42 HP AIRSTAGE V Series released



2009 VRF Heat Pump Modular type Maximum 48 HP AIRSTAGE V-II Series released



2009 Air to water system released

WATERSTAGE

For Light commercial use

2011 Compact 2 Fan type VRF AIRSTAGE J-II Series released

2014 Compact 1 Fan type VRF AIRSTAGE J-IIS Series released

2016 Compact 2 Fan type VRF AIRSTAGE J-III Series released

2017-19 Compact VRF AIRSTAGE J-IIIIL Series for light commercial use released

2020 Compact & lightweight outdoor unit AIRSTAGE J-IVL, J-IV, J-IVS Series released



2019 New cassette style released 3D Flow Cassette

For Commercial use

2012 VRF AIRSTAGE VR-II Series released

2014-15 VRF AIRSTAGE VR-III Series released

2020 Heat Recovery Modular type VRF AIRSTAGE VR-IV Series & AIRSTAGE Air handling unit released



2022 Energy-saving operation model VRF V-IV Series released

VRF V-IV

For Residential use

2011 Hi-spec Design model LT Series & LU Series released

2017 Flagship Wall-mounted type "nocría X" released

2017-19 Added to this lineup recently are the environment-friendly R32 refrigerant models. (Split & Multi-split type)

2022 Harmonizes beautifully design model KE Series released



For Commercial use

VRF J-VS

2024 New VRF products with R32 refrigerant released



For Light commercial use

For Residential use

R32 Split & Multi-split New Wall-mounted type & Duct type with high-energy saving released



KN Series New "Elegant & Smart" Square Design model released

KL Series Cooling-enhanced type High-efficiency operation even at high outdoor temperatures

Wired Remote Controller Simple and stylish design that harmonizes with the installation space



1950 ~

1970 ~

2000 ~

2010 ~

2024 What's New

Manufacturing Company Establishment

1955 Head Office established in Kawasaki

1964 Electronic components factory in Ichinoseki



1977 Air conditioner manufacturing company in Hamamatsu (now Hamamatsu business office)

1991 Air conditioner manufacturing company in Thailand

1994 Air conditioner manufacturing company in Shanghai, China

1998 Air conditioner motor manufacturing company in Thailand

2006 VRF air conditioner manufacturing, sale, and service company in China

2007 Air Conditioner Technology Building becomes operational on the premises of the Kawasaki Headquarters. Air conditioner R&D Center in Kawasaki

2009 Compressor Factory begins operation in Thailand

2012 Joint venture in Thailand to manufacture compressors

2016 Commercial use air conditioner R&D Center in Thailand

2019 New building constructed at Kawasaki Head Office to strengthen development capabilities



2020 Building IoT -based manufacturing in Thailand



2023 FGAI R&D New Office: FGAI Research & Development office moved to the new office in New jersey, USA

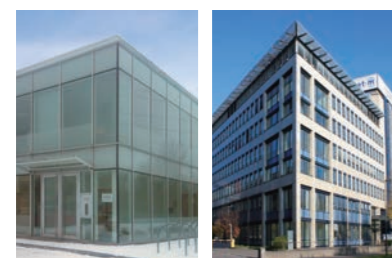

Fujitsu General (UK) Co., Ltd. (UK)



Fujitsu General (EURO) GmbH

Sales & service maintenance company established

1976 North America sales company

1977 Europe sales company (UK)

1978 Australia sales company and Europe sales company (Germany)

1980 Brazil sales company

1997 Asia sales company (Singapore)

1998 Middle East sales company (UAE) and New Zealand sales company

2000 Air conditioner manufacturing and sale technical partnership in India

2002 Taiwan sales company

2006 China sales company

2016 THE AIRSTAGE on Broadway in New York



2023 Communication Lounge EURO: New lounge in Dusseldorf, Germany



*1: Announced 1991. In room air conditioner for the home (Our company's investigation) *2: Announced 1994. In the category of room air conditioners for the home (Our company's investigation). *3: Announced 2002. In the category of room air conditioners for the home (Our company's investigation).

*4: Announced 2018. In room air conditioner for the commercial (Our company's investigation) *5: Announced 2012. In room air conditioner for the home (Our company's investigation)



Worldwide locations

Under a system of five bases in Europe, the Middle East, Asia and Oceania, North and South America, and Japan, the company promotes Globalization from a worldwide perspective while emphasizing the actual conditions in each region.



JAPAN Head Office



Technology research building (Japan)

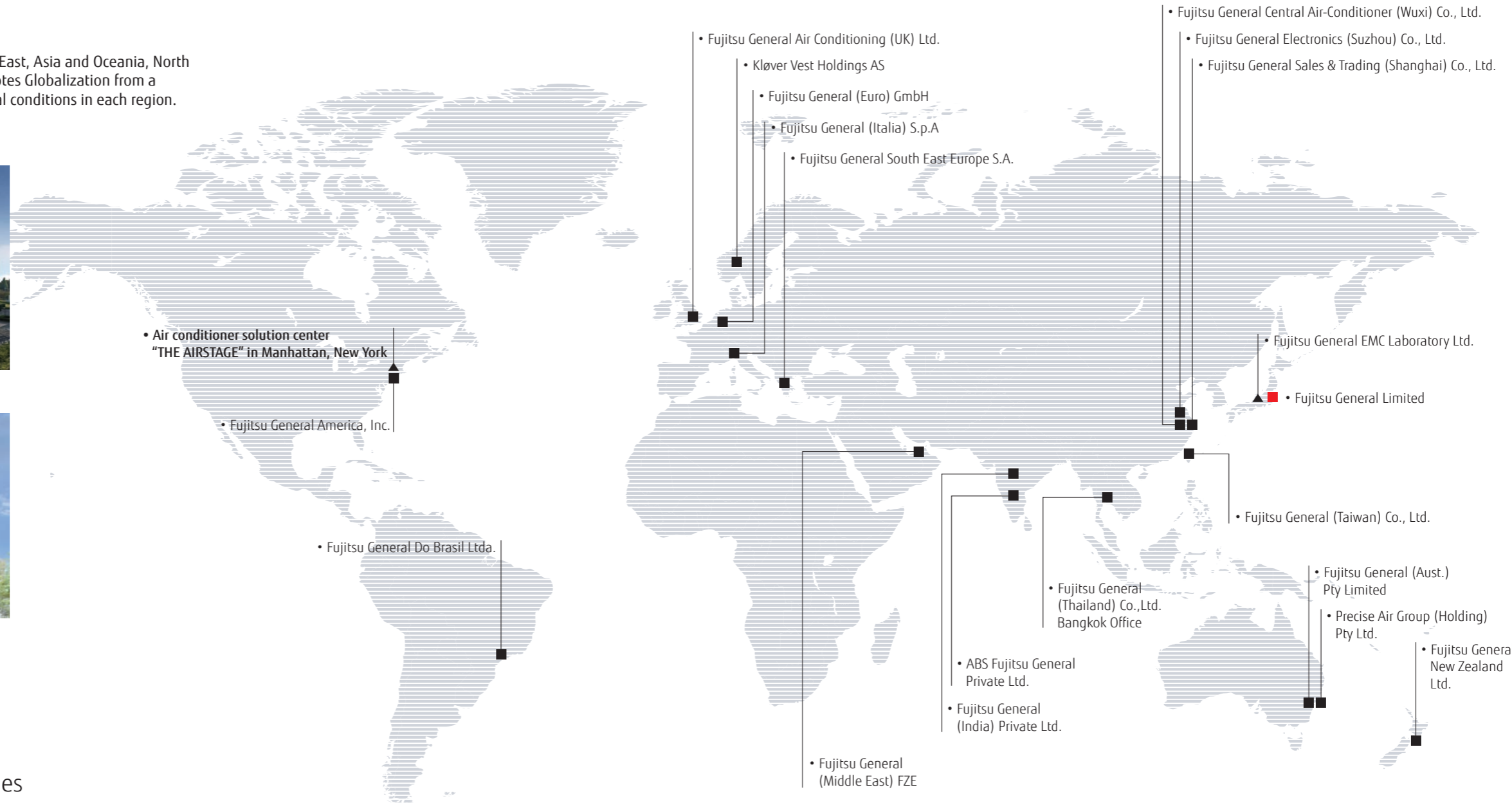

18 Overseas Sales Companies

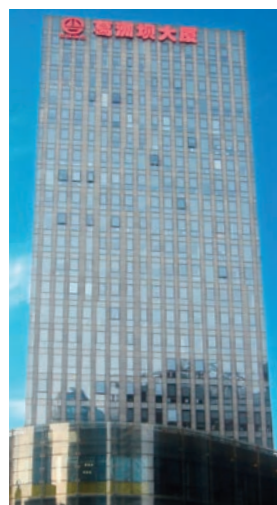

Fujitsu General Sales & Trading (Shanghai) Co., Ltd.



Fujitsu General (EURO) GmbH Co., Ltd. (Taiwan)



Fujitsu General (Thailand) Co.,Ltd. Bangkok Office (Thailand)

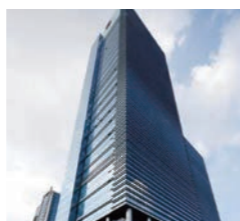

Fujitsu General Electronics (Suzhou) Co., Ltd.



Fujitsu General South East Europe S.A. (Greece)



Fujitsu General (India) Private Ltd. (India)



Fujitsu General Do Brasil Ltda. (Brazil)



Fujitsu General (Italia) S.p.A (Italy)



Fujitsu General (India) Private Ltd. (India)



Fujitsu General (Aust.) Pty Ltd. (Australia)



Precise Air Group (Holding) Pty Ltd. (Australia)



Fujitsu General New Zealand Ltd. (New Zealand)



Fujitsu General (Middle East) FZE (U.A.E.)



ABS Fujitsu General Private Ltd. (India)

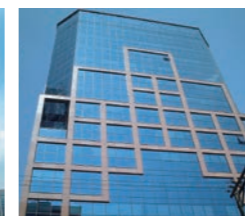

Fujitsu General (Aust.) Pty Limited



Fujitsu General America, Inc. (U.S.A.)



Kløver Vest Holdings AS (Norway)



FUJITSU GENERAL SOLUTION CENTER "THE AIRSTAGE" (U.S.A.)



Global business activities

We have been recognized for our activities in advertising, human resource development and customer service, as well as for our community-based social contribution activities in each region, winning numerous awards and achieving a high level of customer satisfaction.

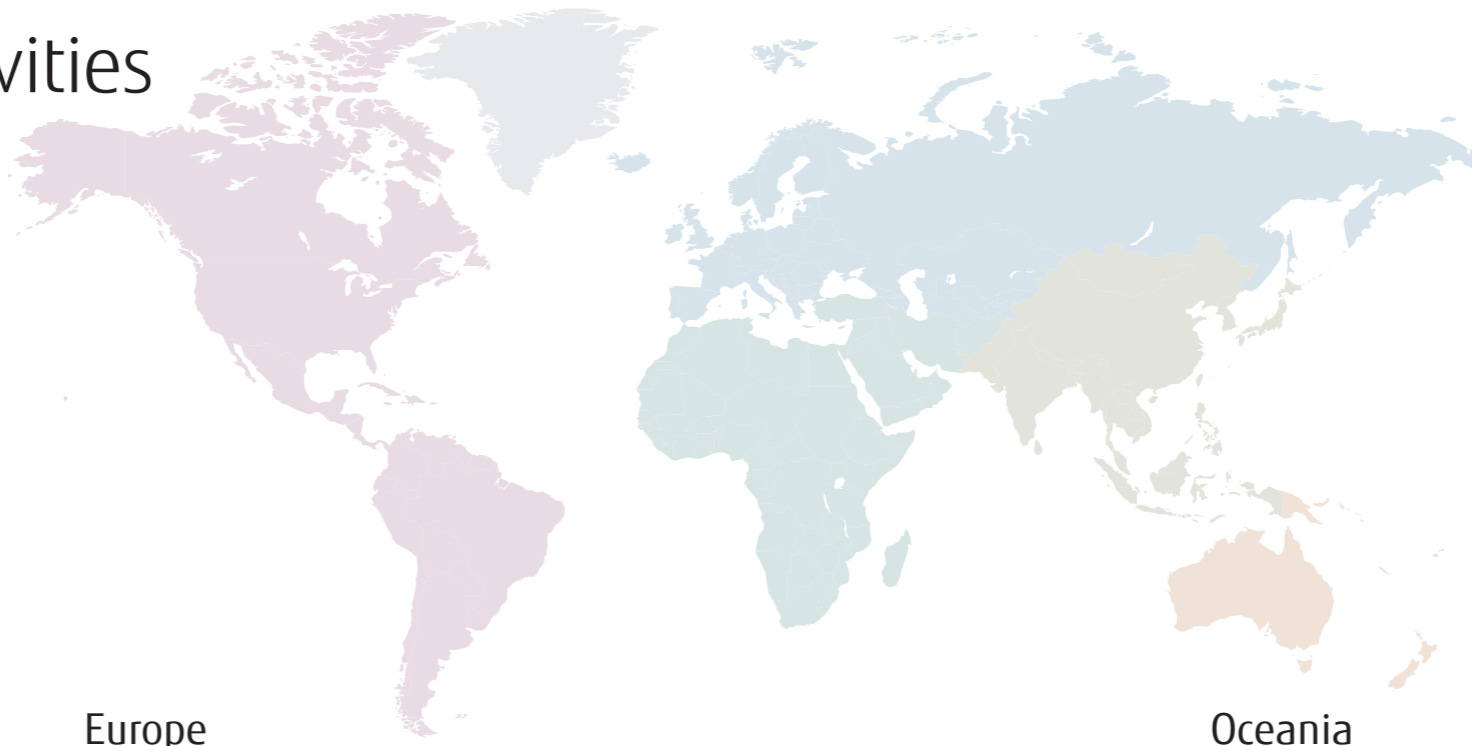

North and South Americas



AHR Expo



HVAC trade shows in Brazil



Distributor conference in USA



Call center

Middle East



Exhibition



Training in Kuwait



Launch event in Oman

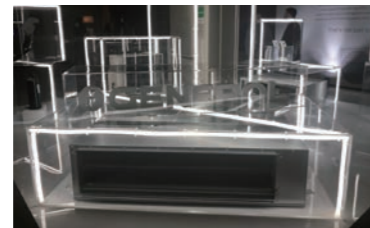

New product seminar in UAE

Europe



HVAC trade show in Germany



Training in Germany



HVAC trade show in Germany



Training seminar in Italy



Event in the United Kingdom

Oceania



HVAC trade show in Australia

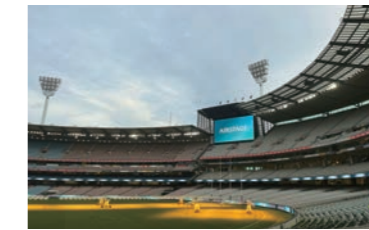

Launch event in New Zealand



Launch event in New Zealand

Asia



Thanksgiving party in Taiwan



Exhibition in India



Opening ceremony in India



New product presentation seminar in Singapore



Service training in Vietnam

International authoritative design awards



The NEWS Dealer Design Awards



Gold Award (Category: HVAC & PLUMBING) in Reader's Choice Awards



TOP OF MIND 2016 First prize in "MARCA DE EQUIPAMENTO DE AR-CONDICIONADO" category of "CLIMATIZACAO" division



Superbrands is the world's largest independent arbiter of branding.



The iF Product Design Award is given annually by iF International Forum Design GmbH for industrial products from around the world.



The Plus X Award is the world's largest innovation award for technology, sports and lifestyle.



reddot winner 2020

A product design competition that has been held since 1955. Products that win the award are given the "Red Dot" seal, a sign of international recognition of quality.



One of the famous design award in the world. Designs are judged on innovation and aesthetics, as well as their benefit to users, clients/brands, and society.



ProductReview.com.au's annual awards are selected from products and services that have been well-rated by the ProductReview community.



Voted by Australians as the 'Most Trusted Brand - Air Conditioning Category 5 Years Running'



China State Construction Engineering Luban Prize



The Good Design Award is an award sponsored by the Japan Institute of Design Promotion, and is given once a year to items of outstanding design.



Project references

Introduced in over 50 countries worldwide

Highly popular for their excellent quality, energy efficiency, and ease of installation, Fujitsu General's products are installed in a wide range of buildings around the world, including high-rise office buildings, stores, hotels, public facilities, schools, hospitals, and residences.

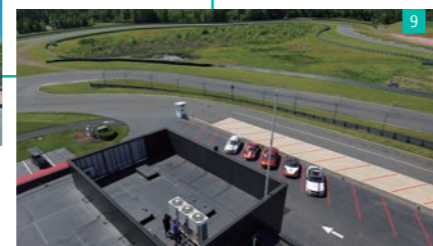
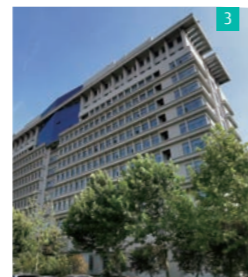

For Light commercial use

- 1 Shop in Europe
- 2 Factory in Europe
- 3 School in Asia
- 4 Hospital in Asia
- 5 Office in Asia
- 6 Shop in Oceania
- 7 Office in Oceania
- 8 School in the Middle East
- 9 Public facility in the United States

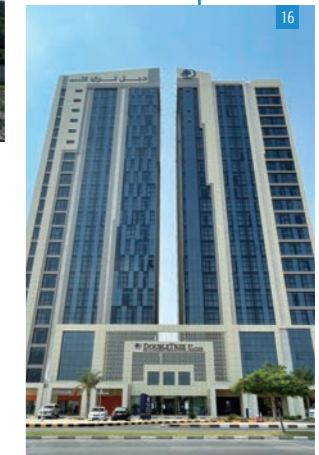
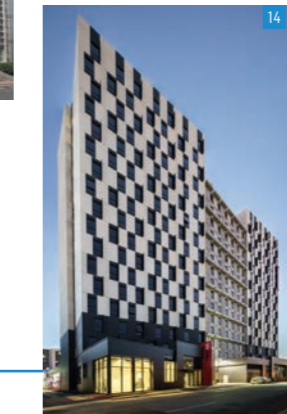

For Commercial use

- 10 Public Square in Asia
- 11 Hotel in Asia
- 12 Hotel in Asia
- 13 Public facility in Asia
- 14 Apartment in Oceania
- 15 Apartment in Oceania
- 16 Hotel in the Middle East
- 17 Hotel in the Middle East



For Residential use

- 18 Villa in the Africa
- 19 Residence in Oceania
- 20 Residence in the United States
- 21 Villa in the Middle East





Global development & Production bases

We have established R&D bases in five countries from Japan, Europe, Asia, China, and North America to pursue environmental properties and comfort according to the needs of each region.

- Head office
- R&D center
- Manufacturing companies



R&D center & Technology Research Building



R&D center in Fujitsu General (EURO) GmbH (Germany)



North America R&D Center (USA)



Fujitsu General Air Conditioning R&D (Thailand) Co., Ltd. (Thailand)



R&D center in Fujitsu General (Shanghai)



JAPAN Head office, R&D center and 60 m height difference testing tower (Japan)

Technology research building in Japan Head office



Constructing IoT-based manufacturing
We are implementing a real-time IoT-enabled system to immediately visualize and analyze various information such as facility operating status, assembly line production progress, and parts inventory and transportation status. This will further enhance the accuracy of production and shipping forecasts in the Head Office and factory management departments. The system will also help improve activities by employees at production sites, with the aim of improving the efficiency of the production process, the efficiency of parts distribution operations, and the utilization rates of the facilities.

Overseas manufacturing companies



Fujitsu General (Shanghai) Co., Ltd. (China)



F.G.L.S. Electric Co., Ltd. (China)



Fujitsu General Central Air-conditioner (Wuxi) Co., Ltd. (China)



Fujitsu General Electronics Ltd. (Japan)



Fujitsu General (Thailand) Co., Ltd. (Thailand) Factory-2



Fujitsu General (Thailand) Co., Ltd. (Thailand)



Fujitsu General Air Conditioning R&D (Thailand) Co., Ltd. (Thailand)



FGA (Thailand) Co., Ltd. (Thailand)



TCFG Compressor (Thailand) Co., Ltd. (Thailand)



High-quality development & Production facilities

Advanced Research Facilities and Equipment

Performance tests



Airflow measurement room
Measure the airflow of air conditioners, from compact room air conditioner models to variable refrigerant flow (VRF) systems.



Calorimeter
Measure the temperature, humidity, and airflow at the inlet and outlet of the air conditioner to evaluate its cooling and heating capacity.



Silent room
Measure the operating sounds of air conditioners on walls and ceilings with reduced sound reflection.

Fujitsu General is one of Japan's leading manufacturers with R&D centers in Japan. The research and development conducted in these facilities contributes to providing our customers with the highest quality and performance.

Reliability tests



Constant temperature room
Verify product performance in cooling and heating operations under various temperature and humidity conditions.



Practical test room
Check whether the performance of the air conditioner can be sustained under the conditions of the actual housing environment.



Shower test room
Check if the electrical box of the outdoor unit is protected from strong wind and rain, such as during a typhoon.

Transportation and Handling Tests



Compressibility test



Vibration test



Technology research building in Japan Head office

Testing laboratory

Fujitsu General EMC Laboratory Limited

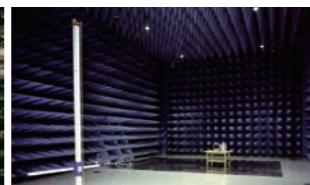
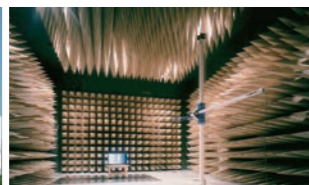

60-m Height Difference testing tower

Tests oil circulation in a compressor for reliability.



Certification of ISO 9001 and ISO 14001

■ ISO 9001
■ ISO 14001
() Number of companies

The Group's 5 overseas production subsidiaries are individually certified with ISO 9001 and ISO 14001. The Group's 11 overseas sales subsidiaries have been certified with ISO 14001 since 2012.

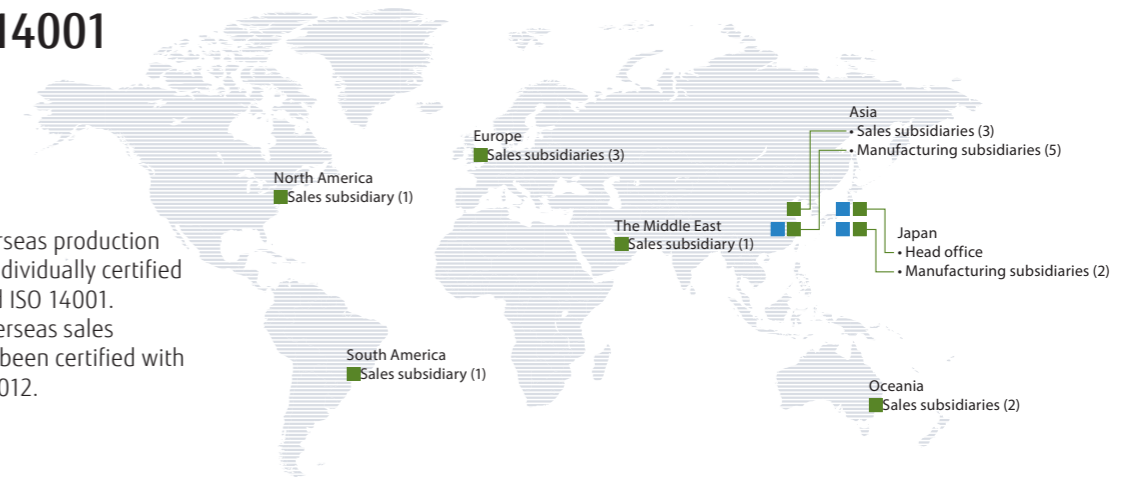

Product Quality Assurance

All Fujitsu General plants are ISO 9001 certified and operate under a unified quality control system. We deliver to customers all over the world high-quality products that have passed stringent quality inspections.

Receiving inspection

We require all our parts suppliers to submit test reports to ensure that all parts we receive from them meet our quality standards. Our in-house test department inspects incoming parts to ensure their compliance with RoHS as required by the EU. We also conduct 100% inspection of main parts to prevent defective parts from making it to assembly lines.

Quality inspection of products

We carry out stringent quality inspections in all production processes performed in our plants. To keep the quality of our products high, inspectors check their quality from start to finish on production lines.

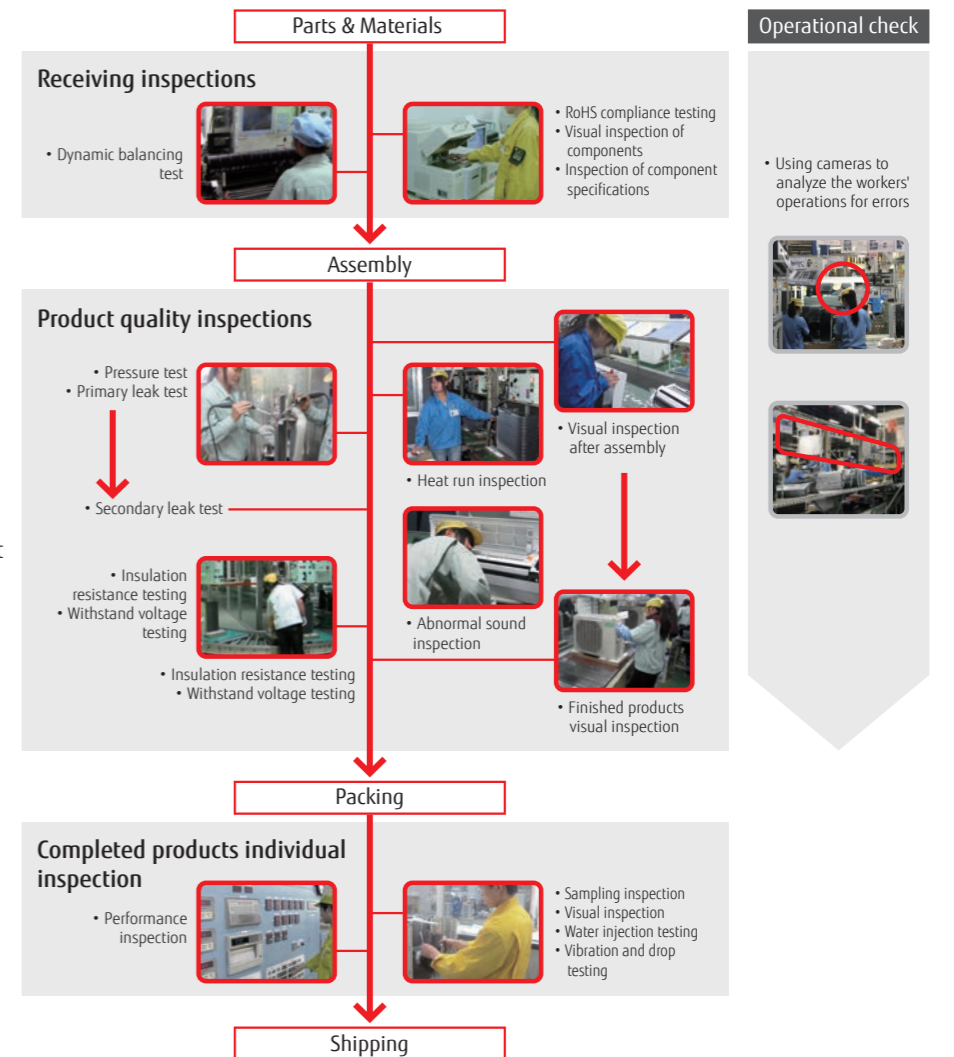

Operational check

Using cameras to analyze the workers' operations for errors



2024 New Products



R32 Split, Wall-mounted type
Built-in W-LAN adapter models

KL Series ECO Range
Compact Size (Cooling-enhanced type)

S-032-033

- 7-12 classes, 3 models
- Elegant & smart square design
- High energy saving
- Comfortable airflow & Quiet operation
- Smart device control
- Easy access to the flare pipe connection



SPLIT



MULTI-SPLIT



Wall-mounted type Built-in W-LAN adapter models

Designer Range, Standard Range

S-016, 020 **M-006, 022**

- Improved energy efficiency from the current products
- 7-14 classes, 8 models
- High energy saving
- Built-in WLAN adapter
- Comfortable airflow & Quiet operation
- Easy access to the flare pipe connection



KG Series Designer Range
High Spec & Design



KM Series Standard Range
High-Efficiency & Comfort

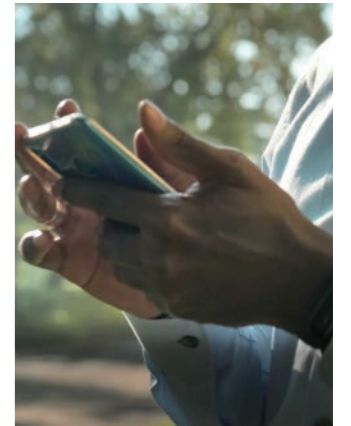

Smart Device control
You need to install the "AIRSTAGE Mobile" app on your smart device in order to control the air conditioner.

ECO Range

S-022-023 **M-006, 023**

- 5-12 classes, 4 models *5 class only for multi-split
- Elegant & smart square design
- High energy saving
- Comfortable airflow & Quiet operation
- Built-in WLAN adapter
- Easy access to the flare pipe connection



KN Series ECO Range
Compact Size



Medium static pressure duct

High-efficiency & Comfort

S-040-043 **M-007, 025**

- 12-54 classes *Multi-split is only 12-22 classes
- Slim & Compact design
- High energy saving
- Easy maintenance
- Drain hose as standard
- Wide range of static pressures

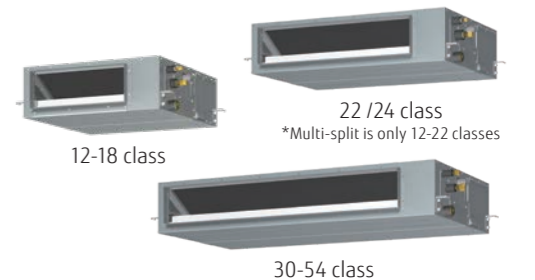



VRF J-VS

Heat Pump for Small-capacity type

Outdoor unit

V-020-025

- **Sustainable:** R32 refrigerant with reduced global warming potential
- **Saving CO2:** Top class high energy saving
- **Small Body:** Easy carriage and installation
- **Situational Piping Design:** Long pipe length, Up to 13 indoor units* can be connected
- **Sightliness installation:** External static pressure, cooling piping system

*: 6 HP model



Indoor unit

V-058-065

- 4 - 24 classes, 3 type, 34 models
- Compact & Slim design
- Flexible installation



Compact Cassette



Low Static Pressure Duct
Slim Duct/Slim Concealed Floor



Wall-mounted type

CONTROL SYSTEM

Wired remote controller

Design type

C-010-011

- Harmonizes with the Installation Space
- Intuitive operation
- Status LED Colors
- Refrigerant cycle monitor
- Logo Display
- AIRSTAGE Remo Set application (free download)
- Initial Settings / Indoor Unit Function



New Monobloc system

Comfort series

Future Release

- 5-10 kW classes, 3 Models
- High energy efficiency
- Quiet operation
- Easy installation & maintenance

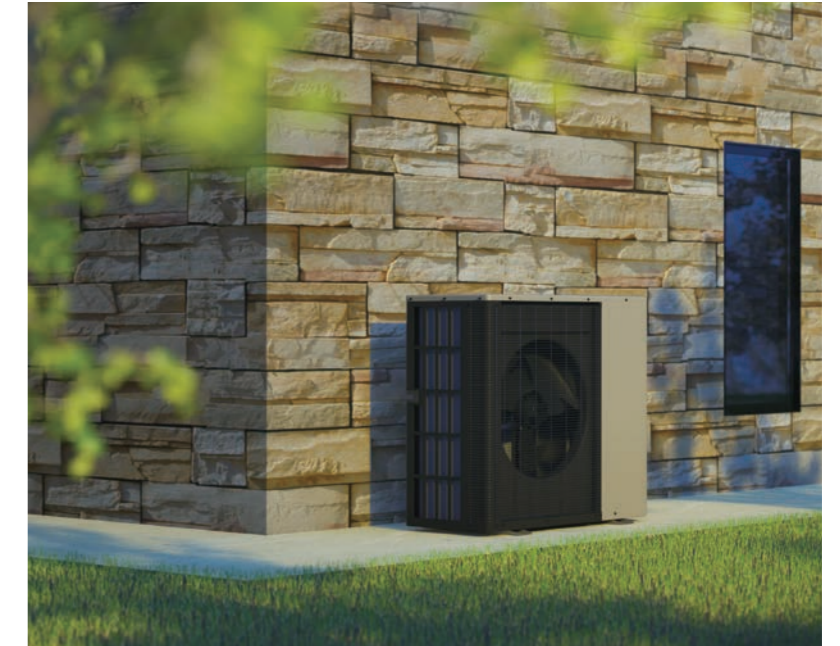

SUPPORT

AIRSTAGE Service Monitor Tool

for Single-split, Multi-split, Air to water

Sp-010-011

- Improved work efficiency
- Bluetooth communication
- Compact and lightweight design
- New application with simple design
- Refrigerant cycle graph display

UTY-ASSXZ1



AIRSTAGE Service Monitor Tool

*Android only.
You need to install the "AIRSTAGE Service Monitor Tool" app on your smart device.



From Business to private spaces
SOLUTIONS

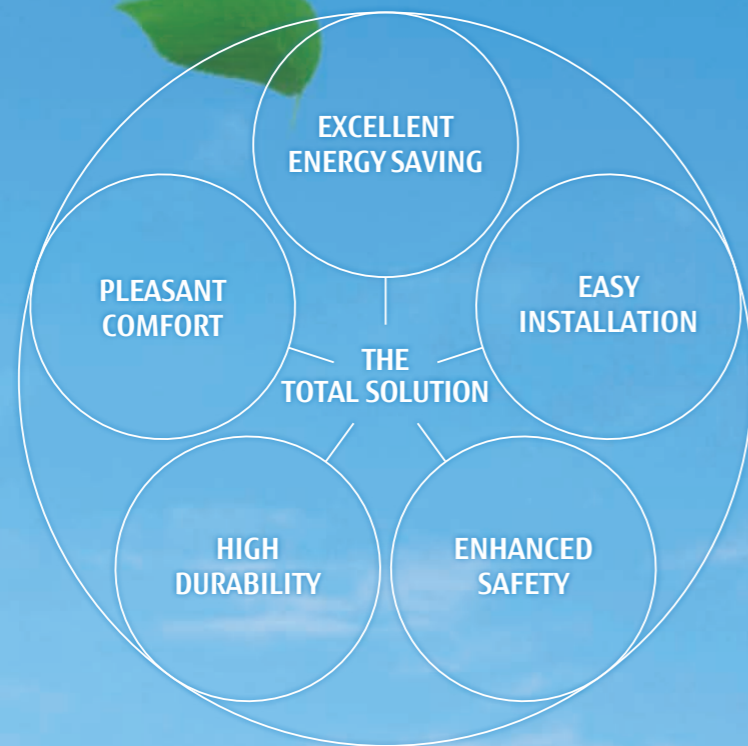

Key solution points

Fujitsu General's total solutions are tailored to each property's unique needs.

Fujitsu General provides the best control solutions for buildings.

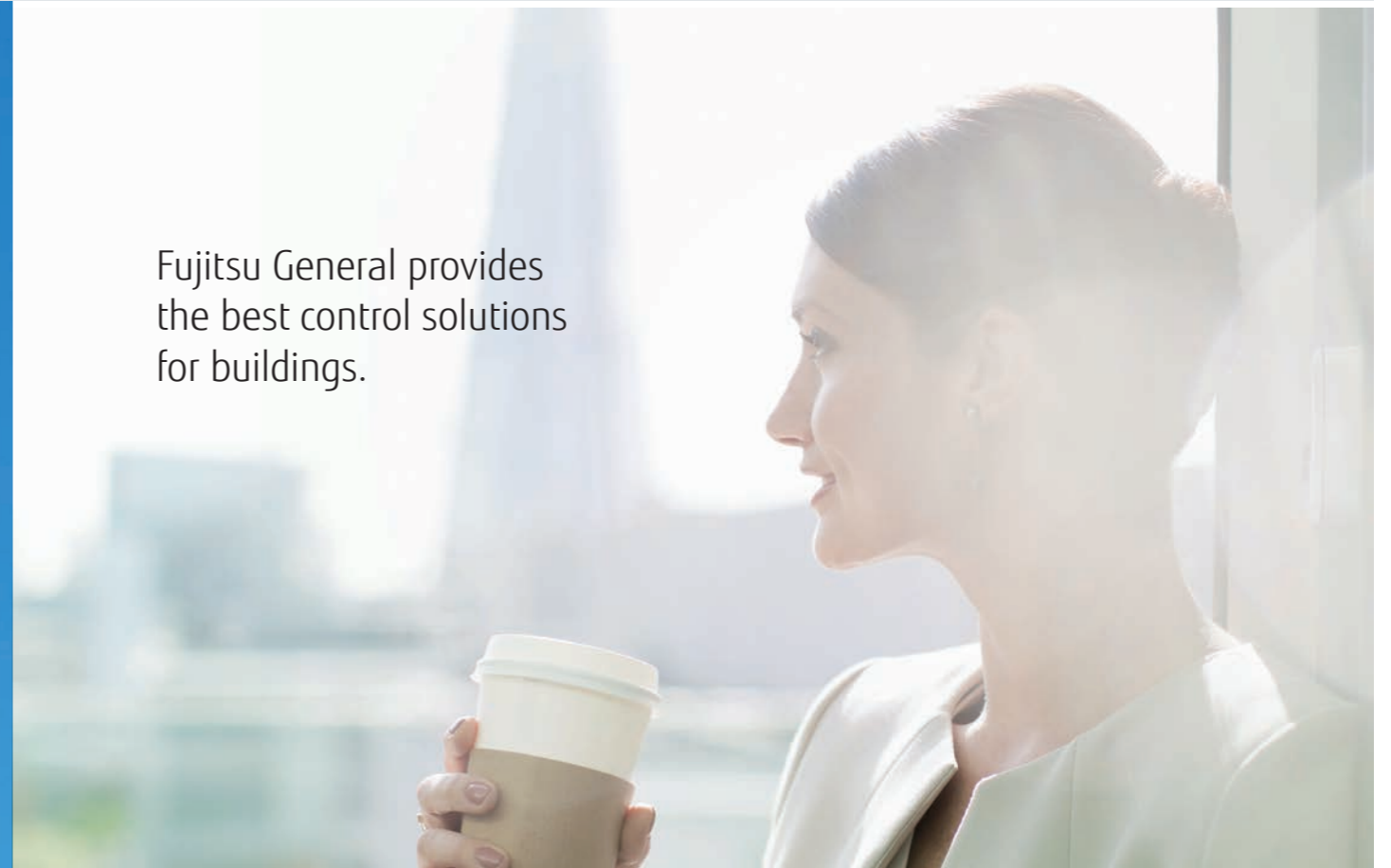

Target buildings

- A casual conversation with a colleague at work
- A presentation in a large meeting room
- A restaurant you stop by Your living room

We have a comprehensive lineup of air conditioners ideal for all these situations—from business to private spaces. Fujitsu General's air conditioners are used in all aspects of everyday life.



For Light commercial use

Comfortable and economical air conditioning systems, ideal for small and midsize commercial buildings

- 036 Restaurants, Shops
- 038 Small offices
- 040 Hotels
- 042 Schools



For Commercial use

Single and modular VRF systems for high efficiency, comfort, design flexibility, ease of installation, and high reliability

- 044 Large Buildings



For Residences

Smart air conditioning systems with extensive control options for comfort and convenience of use

- 046 Residences

Restaurant, shops

For Light commercial use

Fujitsu General provides perfect total air conditioning systems that offer seamless support by tenant, by purpose, and by customer visit frequency in shops and restaurants with multiple lighting and a high density of customers.



Single split

For Restaurants

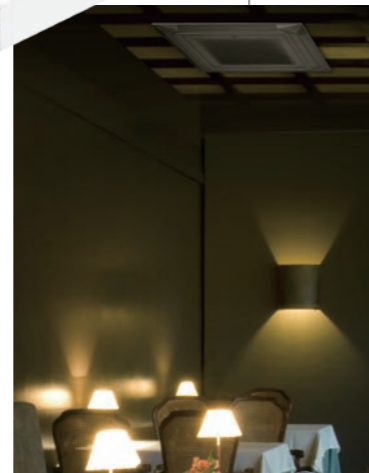
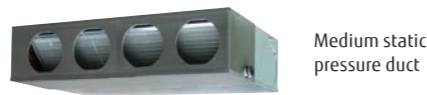
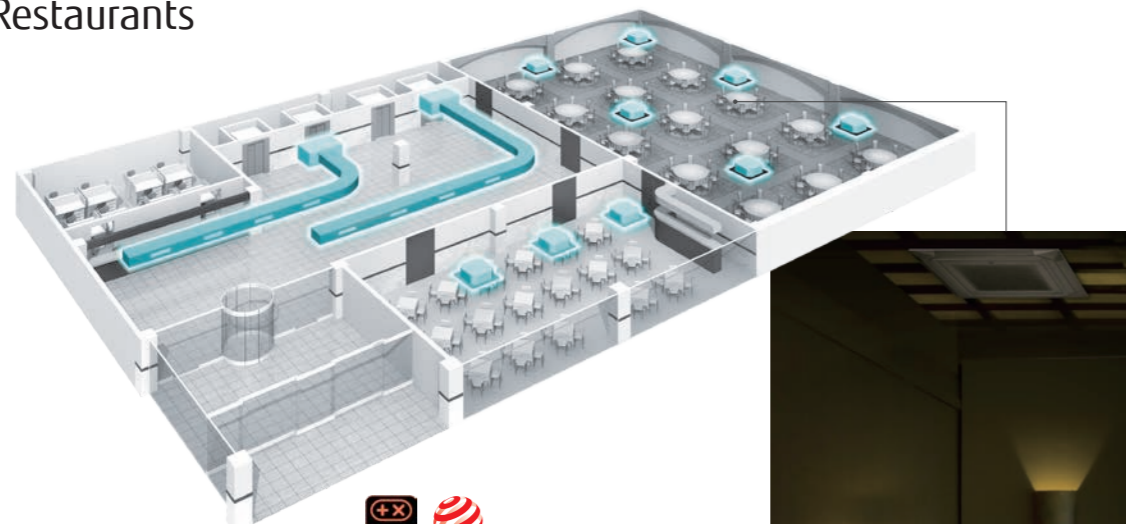

R32 large model lineup expanded

Expanded lineup of ceiling, cassette, and duct types suitable for large spaces using environmentally friendly R32 refrigerant

Two panel colors

Both black and white panels are available for Cassette type. Black panels are suitable for dark places such as atmospheric restaurants. White panels, by contrast, are more appropriate for use in brightly lit spaces such as offices. (Available for Single split and VRF indoor units)

Simultaneous multi-split

For Shops

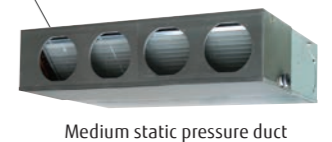
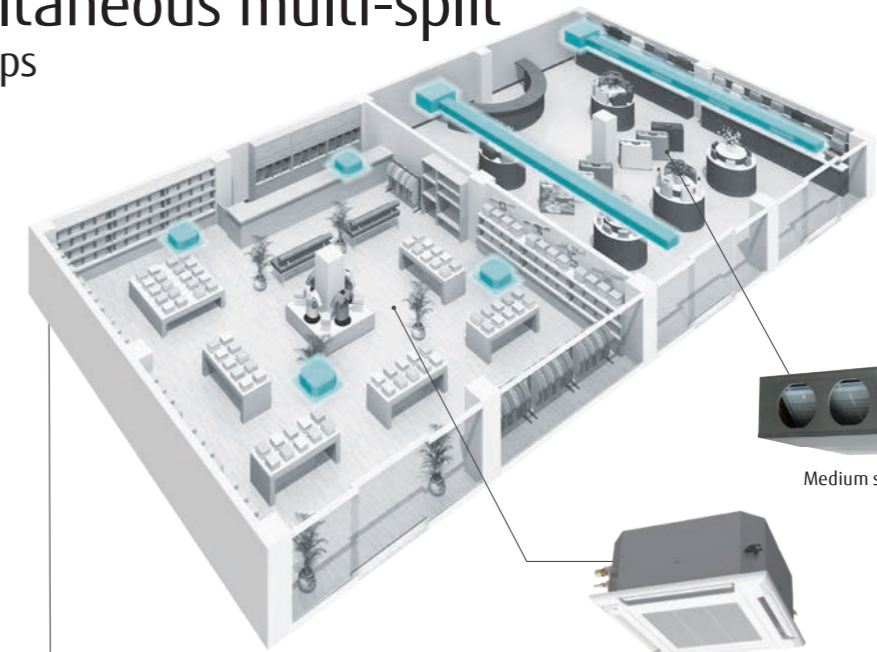

Compact cassette



Various indoor unit lineup

You can choose from 3 types of indoor units to suit the atmosphere and layout of your shop.

Small, lightweight outdoor unit

Models equipped with the new R32 refrigerant. Compared to current models, the outdoor unit is more compact and easier to install. (45/54 models)
Compact cassette Series for grid ceiling were added to the lineup of indoor units to improve ease of installation.

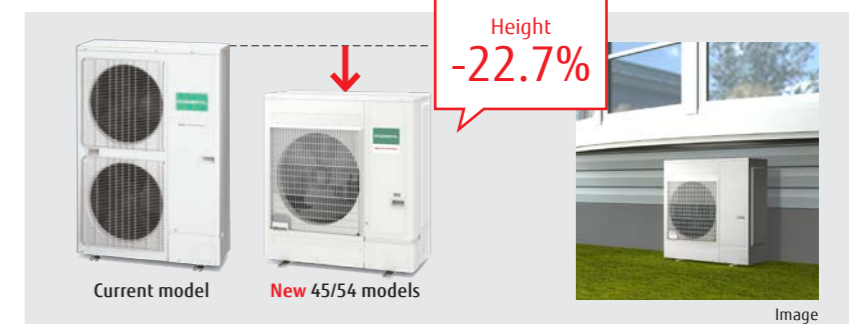

Small offices

For Light commercial use

Fujitsu General offers a perfect total air conditioning system for small office buildings with multiple small rooms, taking into consideration energy savings, low noise, comfortable air volume, usage and purpose, and centralized control.

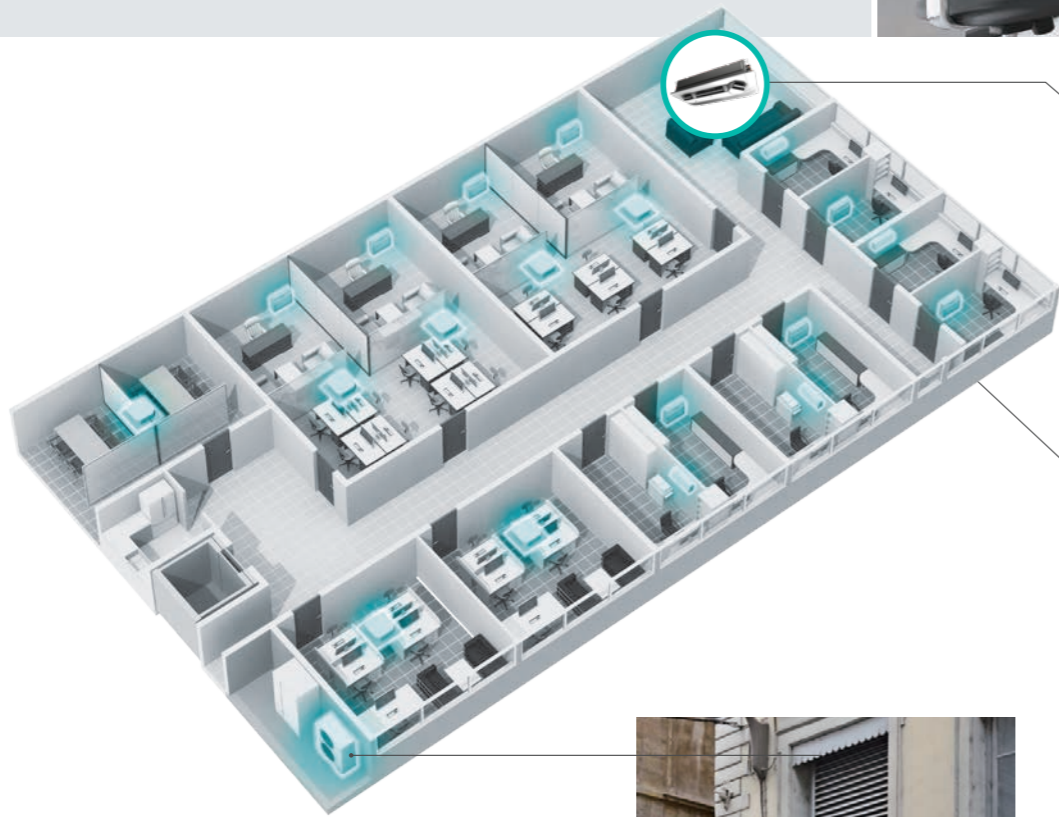

Central remote controller UTY-DCGGZ3

Breakthrough 3D flow cassette with innovative pursuit of comfort

The left and right air outlet ports with a maximum rotation angle of 100° and the wide central air outlet port create a comfortable space with less uneven temperature.



Central remote controller with improved operability

Controls the temperature of each room easily, and manages and sets the operation control for a week. Energy-saving management by setting upper and lower temperature limits and operating prohibitions.

LAN



Computer

Control and monitoring

You can operate the main unit from your desk. Non-administrators can also operate the air conditioners with a computer, smartphone or tablet PC.

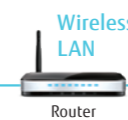

Wireless LAN



Tablet PC

Smartphone

*Wireless LAN will be supported in the future.

Wide lineup of indoor units of low-capacity class

Various low-capacity 1.1 kW indoor units are available for small rooms and spaces.

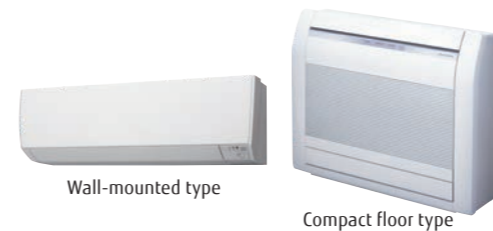

Wall-mounted type

Compact floor type

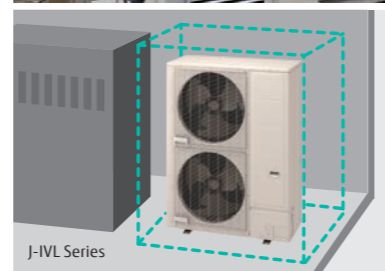

J-IVL Series

Compact outdoor unit with low noise design

Takes up little space even when installed in a machine room or on the roof. Sufficient static pressure can be maintained even with louvers. Low-noise mode suffices even for nighttime operations at low noise levels.



J-IV Series

J-IVL Series

J-IVL Series High-capacity model

VRF J Series compact outdoor units with up to 18 HP

Suitable for the buildings with multiple small rooms. Up to 42 indoor units* can be connected.

*Only J-IVL Series 18 HP model



Compact cassette Series for grid ceiling

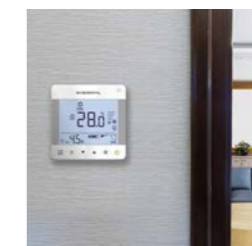

Compact wired remote controller

Compact size with a large screen for easy operation. The stylish design harmonizes with the interior.

Hotels

For Light commercial use

Fujitsu General offers total air conditioning systems perfect for low-rise, small hotels that take into account energy savings, external appearance, safety, and ease of installation.

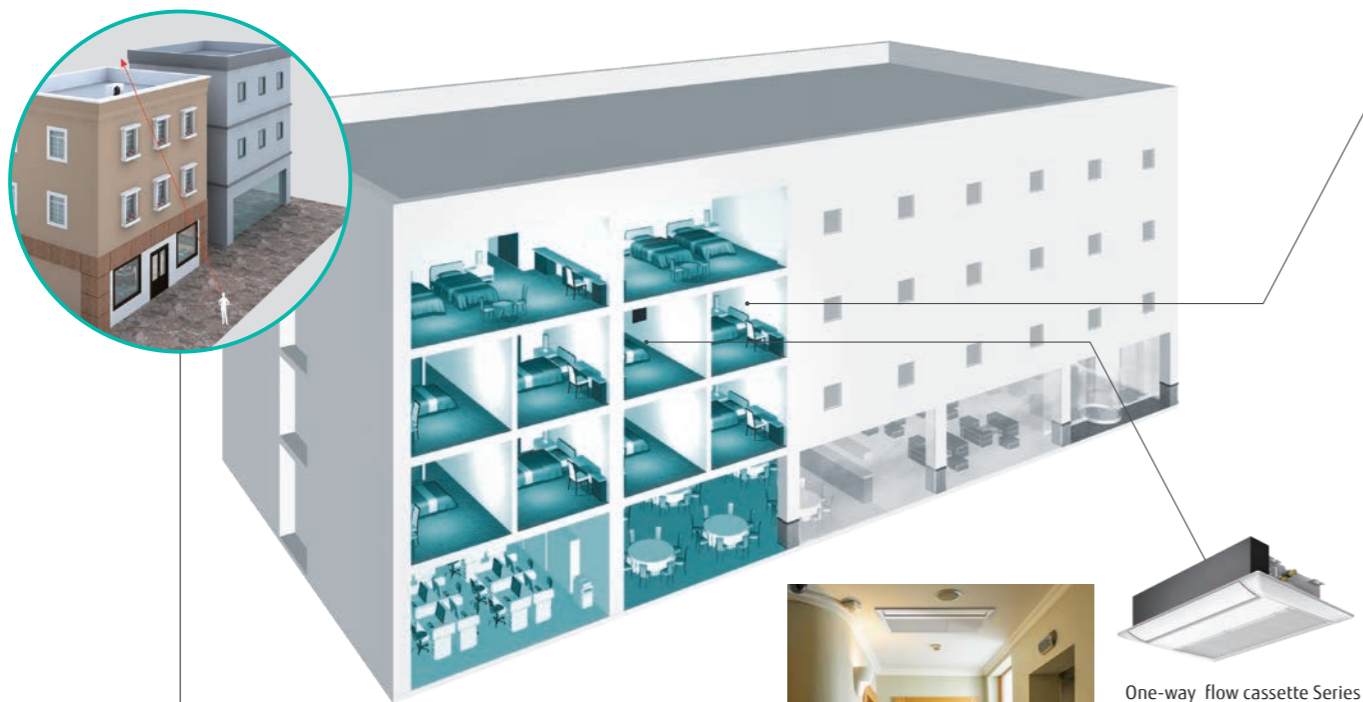

Guest room air conditioning with superior comfort, energy efficiency, and ease of installation

Space saving
Mini duct type with a height of 198 mm and a depth of 450 mm. Easily installed in a narrow ceiling space.



Mini duct



Card key switch available
Linked to a card key to prevent people from forgetting to turn off the air conditioner.



External connection switch

Comfortable airflow by switching the up/down airflow direction
The Auto louver grille kit creates comfortable airflow by adjusting the air direction.

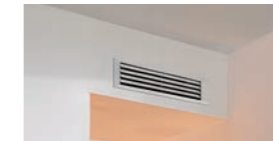

Auto louver grille kit

Ventilation of each room can be achieved relatively inexpensively by combining an appropriate duct fan (locally procured) through a hole for Fresh air in the indoor unit. If the airflow required to ventilate the room is not sufficient, use ERV (Energy Recovery Ventilator).

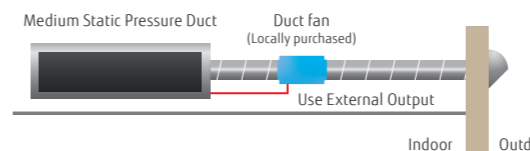

Centralized control of air conditioning for shared spaces

Centralized control of air conditioning for shared spaces Lobbies, hallways, and other common spaces are centrally controlled for air conditioning. Central Remote Controller can manage VRF products, but Split products can also be managed together via Network converter.

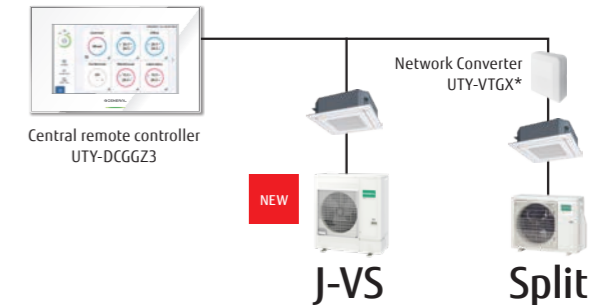

*Some functions will not be available.

Wired remote controller (design type) with sophisticated design. The touch panel can be easily operated by swiping vertically and horizontally.

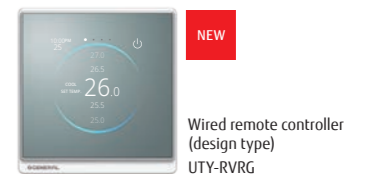

Wired remote controller (design type) UTY-RVRG



Hotel logo display

Large space air conditioning for the reception area and lobby

Duct type Big duct Series suitable for large spaces with high ceilings



Select the product best suited to the characteristics of the property.

	Split	VRF J-VS	VRF VR-IV
Project size	Small	Middle	Large
Individual Air conditioning	Great	Good	Great
Reduction of installation space	Fair	Great	Great
Landscape (hide outdoor unit)	Fair*	Great	Fair
Maintenance (individualized)	Great	Good	Fair

*Depends on pipe length constraints

Schools

For Light commercial use

Fujitsu General offers indoor units that allow multiple connections with a compact design that reduces the installation area and increases the flexibility for selecting installation locations, making them perfect for midsize educational institutions. One single outdoor unit is able to cover an entire school building.

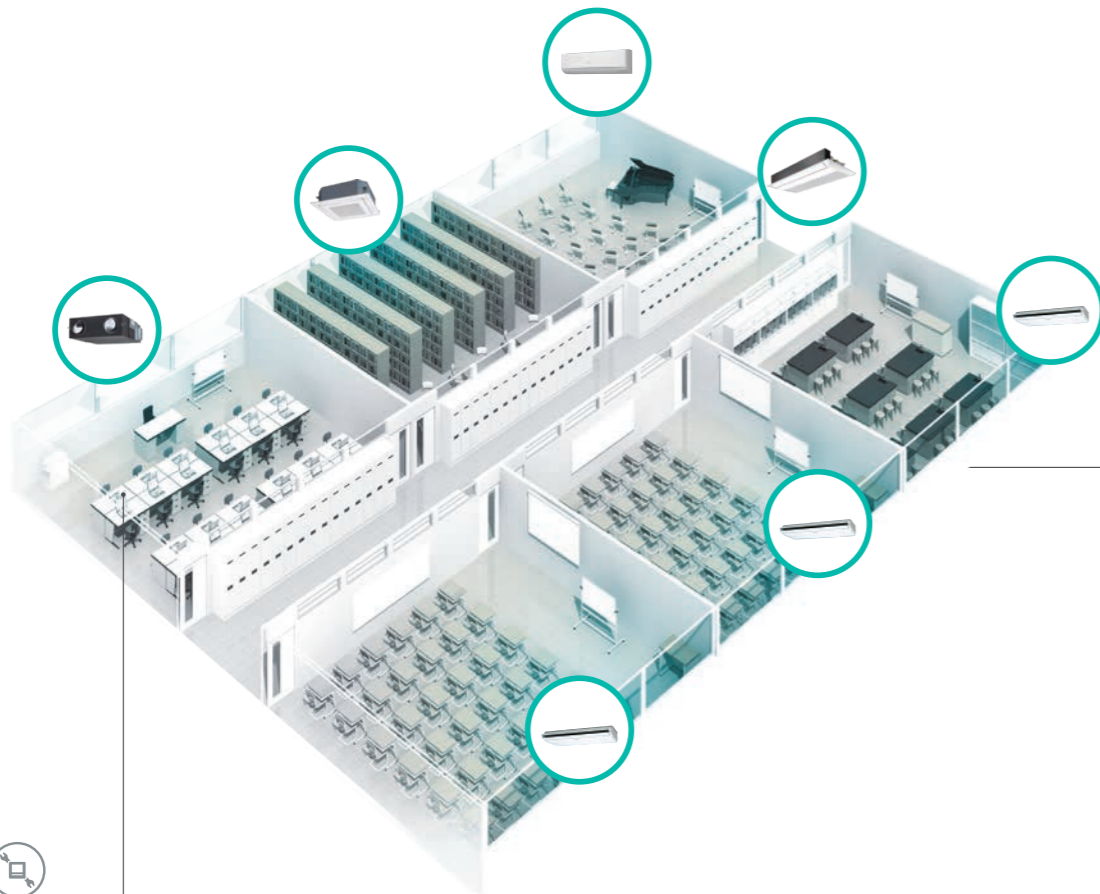

Centralized control of both air conditioning and ventilation equipment

Centralized control is also possible to stop the operation of not only air conditioners but also lighting and ventilation equipment. These features are useful for managing the energy efficiency of the entire building.

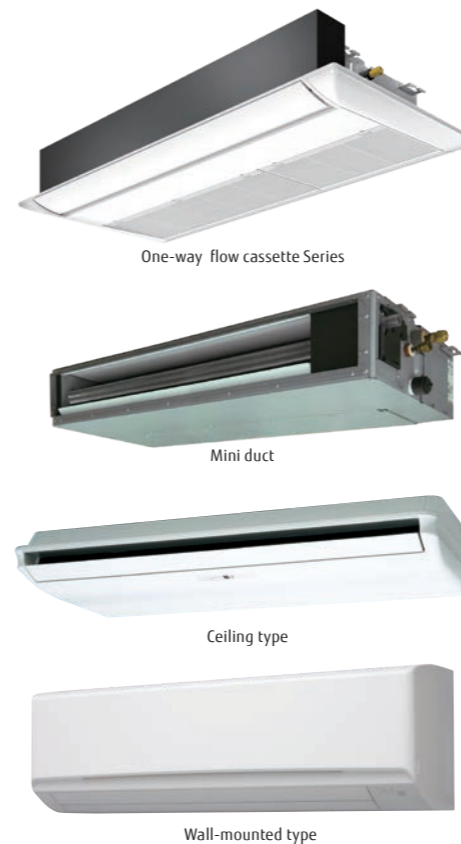
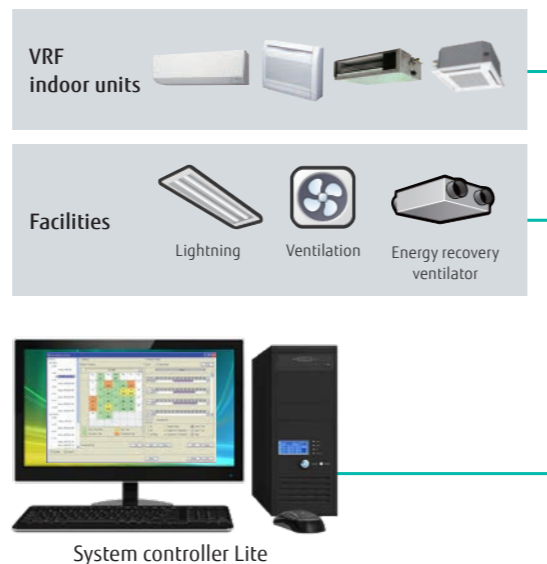

Wide variety of indoor units

Support complex applications for regular classrooms, special classrooms and auditoriums. Ventilators can also be added easily.

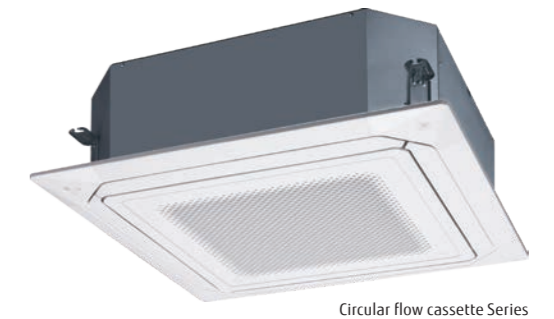

Comfortable room air conditioning without airflow sensation

Circular flow cassette blows air in all directions at a uniform temperature.



Individual airflow direction control to prevent people from being exposed to airflow



Energy-saving operation when unattended, in conjunction with a Human sensor.





Large buildings

For Commercial use

Fujitsu General offers modular VRF systems that pursue high efficiency, comfort, design flexibility, ease of installation, and reliability for high-rise buildings.



Abundant lineup optimized for the operating environment

The VRF system meets a variety of needs, including energy-saving models and models with compatibility to outdoor temperatures of up to 46°C.

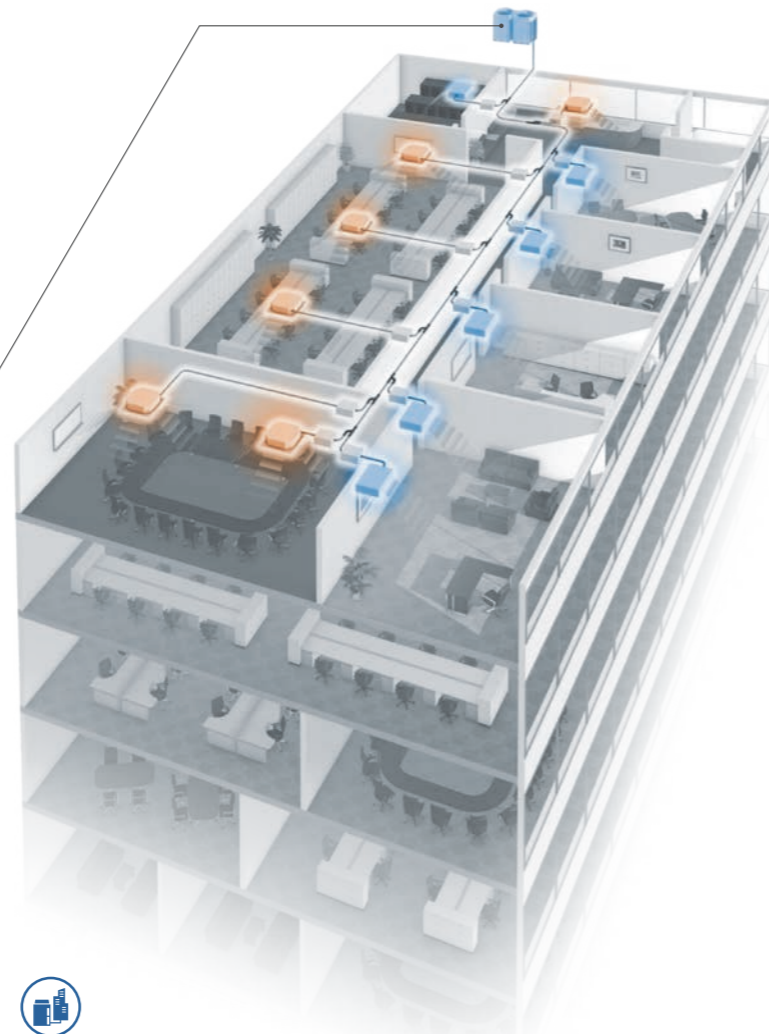

VRF VR-IV

Smart, cutting-edge design Extensive lineup from 8 HP to 48 HP with the capacity ratio of indoor units connectable up to 150%.

34 models with 8 to 48 HP

- Space saving combination: 21 models from 8 to 48 HP
- Energy efficient combination: 13 models from 16 to 44 HP

VRF V-IV

34 models from 8 to 48 HP

- Space saving combination: 21 models from 10 to 48 HP
- Energy efficient combination: 13 models from 16 to 46 HP



Height difference up to 110 m

The height difference between the outdoor unit and the indoor unit is normally 50 m for the V-IV Series, but can be extended to 110 m by installing the Pressure sensor kit.

* Can only be connected to the V-IV Series



Centralized control

Not only indoor units in the building, but also facilities such as ventilation can be controlled easily by anyone



System controller (UTY-APGXZ1)
System controller Lite (UTY-ALGXZ1 & UTY-PLGXX2)



Linkage with various BMS

Linking with MODBUS®, BACnet®, KNX® and other interfaces allows centralized control of equipment other than air conditioning.

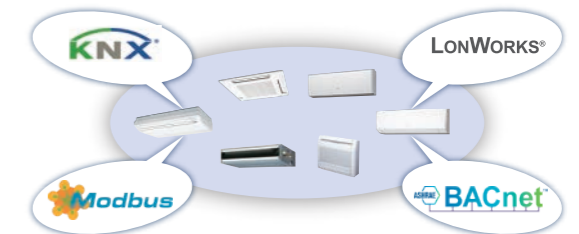

High system flexibility

The industry-leading high static pressure, long pipe design, and connection capacity enable flexible installation on each floor and installation of various indoor units.

82* Pa
*: V-IV Series, 80Pa for VR-IV Series

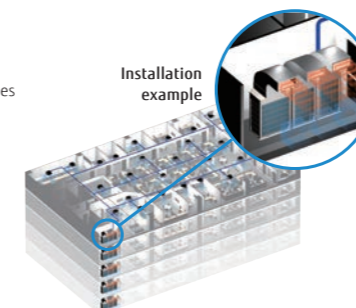
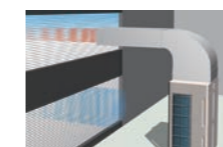

Prompt service support

Web monitoring tool and System controller remotely monitor the air conditioning of the entire building. Self-diagnosis in cooperation with the management company enables quick response in case of an emergency.

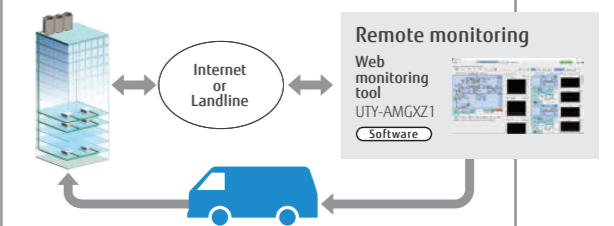

Residences

For Apartments & Houses

From the living room, where the whole family relaxes, to bedrooms, children's rooms and other small rooms, Fujitsu General has designed systems suited to spaces that reflect the rhythm of life.



 A variety of indoor units to suit the characteristics of each room



For Living & Dining room

Cool beauty design model
This series features a special European-style design. The light, elegant and three-dimensional expression achieved by the curved surface is beautiful from all angles.

KE Series



For Large rooms

Standard & Comfort model
The basic functions and powerful, comfortable airflow volume controls are optimal for large spaces.

KM Series



For Primary bedrooms or Living rooms

Award winning design, Quiet models
High performance, low noise with emphasis on design

KG Series
GOOD DESIGN



KM Series
GOOD DESIGN

KN Series
NEW



For Bedrooms or Home offices

ECO Range, Compact size
High performance and compact design suitable for bedrooms, home offices and other small spaces



Outdoor units suitable for residential environments

 **R32 Multi-split type released**

Models are now available with environment-friendly R32 refrigerant. A number of products with improved external design have been added to the indoor unit lineup.

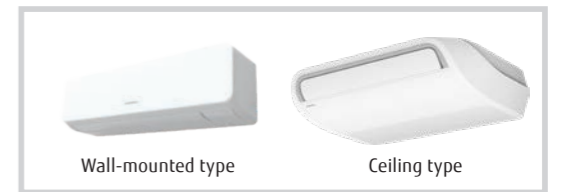

 **Operated by smart speaker**

Simply talk to the smart speaker to operate the air conditioner and check its operating status while doing other things.

+

WLAN adapter (USB)

AIRSTAGE Mobile
Download Free
Available on the App Store and Google Play

With the WLAN adapter and the AIRSTAGE Mobile app, you can control the heating and cooling of your home anytime, anywhere.



Light Commercial & Residential SPLIT & MULTI-SPLIT

Energy saving design to provide a comfortable indoor environment while being environment-friendly.

These are air conditioners that are both user-friendly and environment-friendly. Fujitsu General air conditioners cater to a wide range of needs, from living rooms, bedrooms, stores, small offices, through to hotels.

SPLIT

- Refrigerant R32 models
 - Wall-mounted type
 - Cassette
 - Duct
 - Floor
 - Ceiling
- Refrigerant R410A models
 - Duct

MULTI-SPLIT

- Refrigerant R32 models
 - 2-unit to 5-unit Multi-split
 - Simultaneous Multi-split Twin/Triple
- Refrigerant R410A models
 - 6-unit Multi-split
 - Simultaneous Multi-split Twin/Triple/Double Twin



SPLIT & MULTI-SPLIT

Light Commercial &
Residential



Light Commercial & Residential SPLIT

- S-004 Split Overview
- S-006 Indoor Units Lineup
- S-010 Features
- S-015 Features Explanation
- S-060 Wall-mounted Specifications
- S-063 ECO Series Lineup Specifications
- S-068 Feature Summary



Refrigerant R32 models

Wall-mounted type – Built in W-LAN adapter model

- S-016 Designer Range
 - High Spec & Design
 - Cool Beauty Design
- S-020 Standard Range – High-Efficiency & Comfort
- S-022 ECO Range – Compact Size

Wall-mounted type

- S-024 Standard Range
 - High-Efficiency & Large Rooms
- S-028 ECO Range
 - Compact Size
 - Comfort for Large Rooms
 - Cooling-enhanced type

Cassette

- S-034 Compact 4-way Flow Range – Compact Size
- S-036 Circular Flow Range – Comfort for Large Rooms

Duct

- S-038 Slim Duct – Slim Design
- S-040 Medium Static Pressure Duct
 - High-Efficiency & Comfort
 - Compact Size
 - Standard
- S-050 High Static Pressure Duct

Floor, Ceiling

- S-056 Floor – Compact Size
- S-058 Ceiling



Refrigerant R410A models

Duct

- S-052 High Static Pressure Duct
- S-054 Big Duct



Split Overview

Fujitsu General provides its customers with 5 types and 149 models of air conditioning systems perfect for various customer applications and layouts. Added to this lineup recently are the environment-friendly R32 refrigerant models.



Wall-mounted type, Designer Series, Cool Beauty Design

Existing pipes can be reused if they meet our guidelines

Please consult with our regional sales subsidiaries for details.

Cautions when reusing the existing pipes

- The thickness of the pipes must be 0.8 mm or thicker in accordance with the pipe diameter.
- Use flares that have been reworked to be compatible with the new refrigerant, and are compliant with ISO 14903.
- Select suitable wiring in accordance with the installation manual of the new air conditioning unit.
- When pump-down is not possible or when the inner pipe walls are dirty, make sure to clean the pipes before connecting new ones.
- When using different diameters pipes from the standard sizes,
 - The performance may not reach the published specification value.
 - Dedicated flare nuts compliant with ISO 14903 should be procured locally.
 - Restrictions apply to pipe lengths, refrigerant volumes, and room sizes.



Wall-mounted type

Simple and easy to install, all models, are expertly designed to control airflow and save energy. The design, with its flat and simple appeal, perfectly matches room interiors. Many of the models in the lineup adopt the new environmentally friendly R32 refrigerant.



Duct

The main unit is hidden in the wall, making the room look neat and tidy. Mini Duct and Slim Duct models are also available for installation in narrow spaces between beams or above the ceiling. Large models, suitable for air conditioning vast spaces, allow multiple outlets to be installed in just one unit, and are perfect for atypical room layouts.



Cassette

The Cassette type, which blends in perfectly with the interior design, blows air in all four directions to create an even air-conditioning for the entire space. We have a variety of series including Compact models with a uniquely designed panel to match grid ceilings, and Circular Flow models that send airflow in a 360° direction.



Floor

The compact and slim design makes this model suitable for installation in commercial as well as residential buildings. This model is also recommended as a heating device because it delivers a warm airflow from both the top and bottom outlets.



Ceiling

As with the wall-mounted unit, ceiling installation is very easy, and the unit's thin structure with a height of just 240 mm allows neat installation. The powerful airflow that can reach far away from the wide outlet is perfect for large meeting rooms, audiovisual rooms, and other rectangular spaces with a lot of depth.

Indoor Units Lineup



FUJITSU GENERAL (Euro) GmbH participates in the ECP program for AC. Check ongoing validity of certificate: www.eurovent-certification.com

Type	Range	Refrigerant	Model	Class													
				7	9	12	14	18	22	24	30	36	45	54	60	72	90
Wall-mounted type Built in WLAN adapter model	Designer Range High Spec & Design	R32 Cooling & Heating	NEW KG Series	ASHH07KGTG	ASHH09KGTG	ASHH12KGTG	ASHH14KGTG										
	Designer Range Cool Beauty Design	R32 Cooling & Heating	KE Series	ASHG07KETF ASHG07KETF-B	ASHG09KETF ASHG09KETF-B	ASHG12KETF ASHG12KETF-B	ASHG14KETF ASHG14KETF-B										
	Standard Range High-Efficiency & Comfort	R32 Cooling & Heating	NEW KM Series	ASHH07KMCG	ASHH09KMCG	ASHH12KMCG	ASHH14KMCG										
	ECO Range Compact Size	R32 Cooling & Heating	NEW KN Series	ASHH07KNCA	ASHH09KNCA	ASHH12KNCA											
Wall-mounted type	Standard Range High-Efficiency & Large Rooms	R32 Cooling & Heating	KM Series					ASHG18KMTE		ASHG24KMTE							
	Standard Range High-Efficiency & Large Rooms	R32 Cooling & Heating	KM Series								ASHH30KMTB	ASHH36KMTB					
	ECO Range Compact Size	R32 Cooling & Heating	KP Series	ASHG07KPCE	ASHG09KPCE	ASHG12KPCE											
	ECO Range Comfort for Large Rooms	R32 Cooling & Heating	KL Series					ASHG18KLCA		ASHG24KLCA							
	ECO Range Cooling-enhanced	R32 Cooling & Heating	NEW KL Series	ASHH07KLTA	ASHH09KLTA	ASHH12KLTA											

Indoor Units Lineup



FUJITSU GENERAL (Euro) GmbH participates in the ECP program for AC. Check ongoing validity of certificate: www.eurovent-certification.com

Type	Range	Refrigerant	Model	Class													
				7	9	12	14	18	22	24	30	36	45	54	60	72	90
Cassette	Compact 4-way Flow Range Compact Size	Cooling & Heating			AUXG09KVLA	AUXG12KVLA	AUXG14KVLA	AUXG18KVLA	AUXG22KVLA	AUXG24KVLA							
	Circular Flow Range Comfort for Large Rooms	Cooling & Heating	 18/22/24 30/36/45/54					AUXG18KRLB	AUXG22KRLB	AUXG24KRLB	AUXG30KRLB	AUXG36KRLB	AUXG45KRLB	AUXG54KRLB			
Duct	Slim Duct	Cooling & Heating	 09/12/14 18		ARXG09KLLAP	ARXG12KLLAP	ARXG14KLLAP	ARXG18KLLAP									
	Medium Static Pressure Duct High-Efficiency & Comfort	Cooling & Heating	 12/14/18 22/24 30/36/45/54			ARXH12KMTAP	ARXH14KMTAP	ARXH18KMTAP	ARXH22KMTAP	ARXH24KMTAP	ARXH30KMTAP	ARXH36KMTAP	ARXH45KMTAP	ARXH54KMTAP			
	Medium Static Pressure Duct Compact Size	Cooling & Heating	 12/14 18/22/24/30 36/45/54			ARXG12KHTAP	ARXG14KHTAP	ARXG18KHTAP	ARXG22KHTAP	ARXG24KHTAP	ARXG30KHTAP	ARXG36KHTAP	ARXG45KHTAP	ARXG54KHTAP			
	Medium Static Pressure Duct Standard	Cooling & Heating							ARXG22KMLB	ARXG24KMLA	ARXG30KMLA	ARXG36KMLA	ARXG45KMLA				
	High Static Pressure Duct	Cooling & Heating											ARXG45KHTB	ARXG54KHTB			
		Cooling & Heating													ARHG60LHTA		
	Big Duct	Cooling & Heating														ARHG72LHTA	ARHG90LHTA
Floor Compact & Comfort	Cooling & Heating				AGHG09KVCA	AGHG12KVCA	AGHG14KVCA										
Ceiling	Cooling & Heating	 18/22 24/30 36/45/54						ABHG18KRTA	ABHG22KRTA	ABHG24KRTA	ABHG30KRTA	ABHG36KRTA	ABHG45KRTA	ABHG54KRTA			

Features

High-Efficiency

ALL DC All DC Inverter Technology



DC twin-rotary compressor

A high-efficiency 2-cylinder rotary compressor with a DC inverter optimizes the internal structure of the compressor to achieve higher energy efficiency compared to similar compressors.

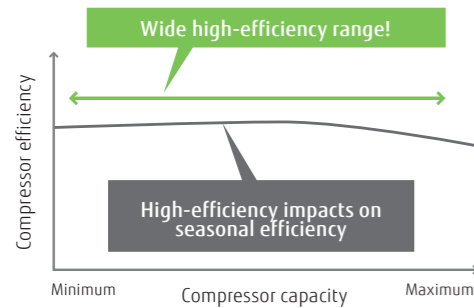

DC fan motor

The DC fan motor produces high power, a wide operating range, and high-efficiency.



Sine-wave DC inverter control

High-efficiency operation is realized by using sine-wave DC inverter control.

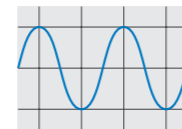

Heat Exchanger for Wall-mounted type

High-density multipath heat exchanger

Thinner and denser heat exchangers and multipath efficiency technology have substantially improved heat exchange performance.

High-performance sub-cool heat exchanger

A counter-type bypass circuit has been incorporated to achieve a higher performance. (Large multi-split type, VRF)

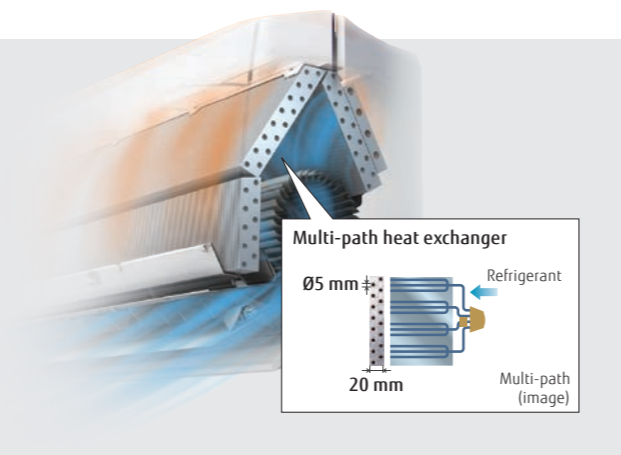

High Energy Saving

Human sensor control

The Human sensor monitors the movements of people in a room and operates the air conditioner at a lower capacity when people leave the room. When people come back to the room, it automatically returns to the previous operating mode.

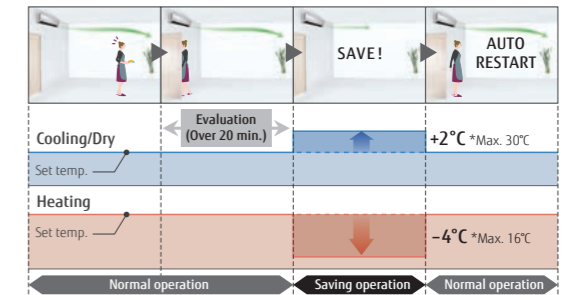

Economy operation

Limits maximum operation, reducing the power consumption, and thereby suppressing the maximum load.

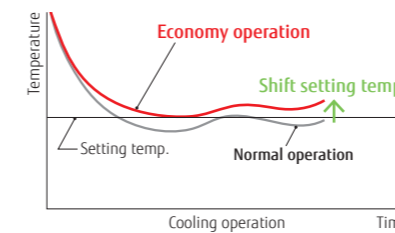

Setting temperature range limitation

The minimum and maximum temperature range can be set giving further energy savings while considering the comfort of the occupants.

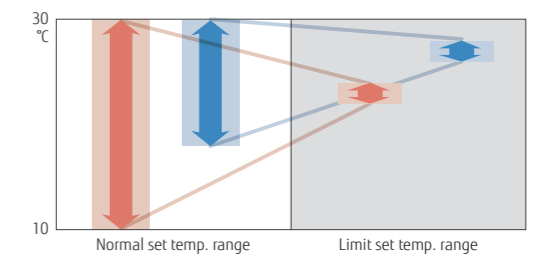

Set temperature auto return

- The set temperature automatically returns to the previously set temperature.
- The time range in which the set temperature can be changed is from 10 to 120 minutes.

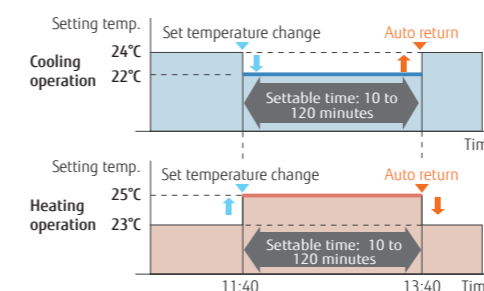

Auto-off timer

- The indoor unit is automatically turned off when it reaches a preset operating time frame.
- The time frame of the Auto-off timer can be flexibly scheduled.
- Auto-off times can be set from 30 to 240 minutes.

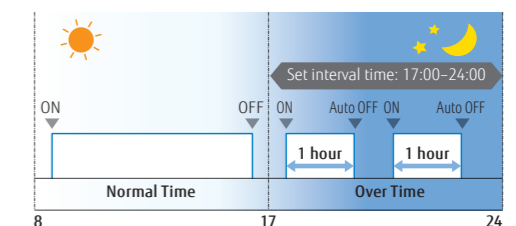

More Comfort



Power diffuser
 These three technologies enable precise wind direction control and improve ventilation efficiency; our airflow control offers a more comfortable environment.

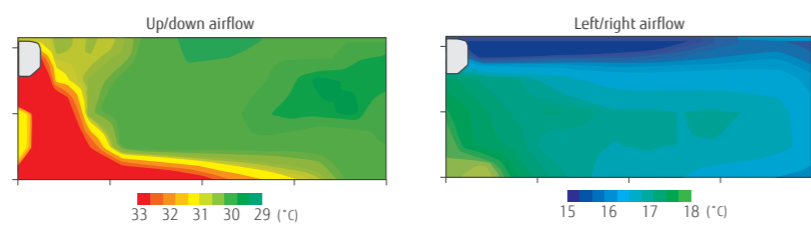

Wireless LAN control
 Users can control their air conditioners from anywhere with their mobile devices while out or on the move.

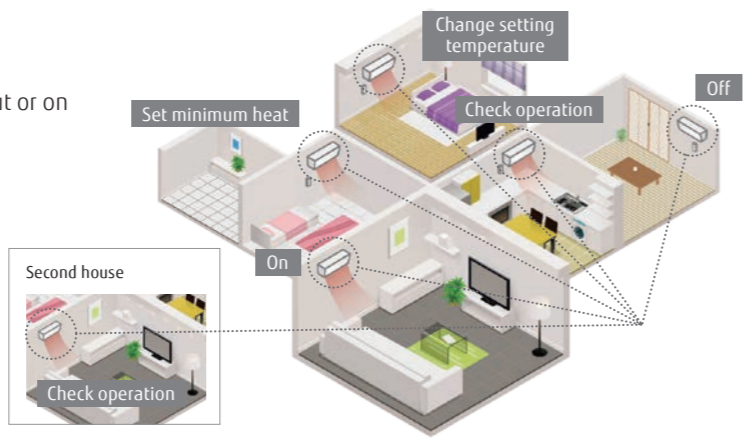

Powerful operation
 Maximum airflow and maximum compressor speed are maintained for the period necessary to reach the set temperature quickly.

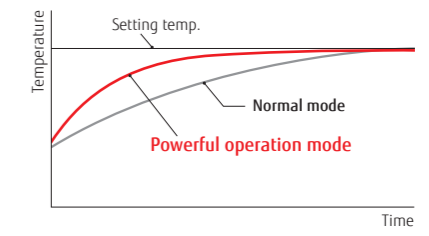

10°C heat
 After a person has left the room, the system switches to minimum heating operation to maintain the room temperature. (Maintained at 10°C)

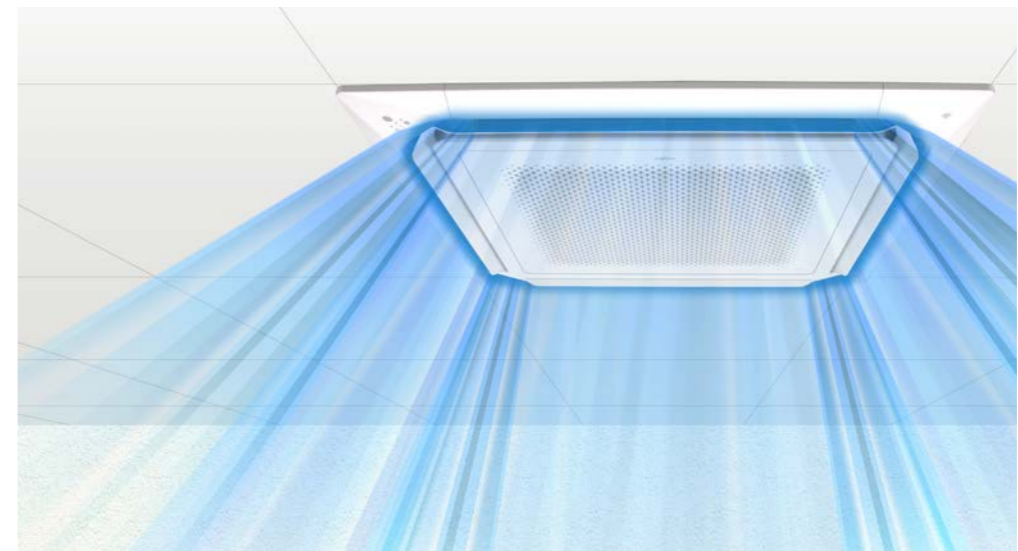
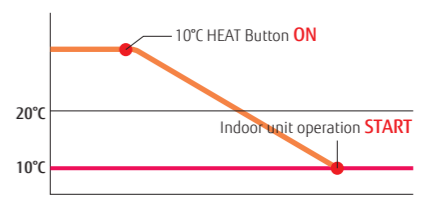

Uniform air conditioning
 Circular airflow to achieve uniform air conditioning without temperature unevenness in workspaces



Quiet and Comfort Control



Low Noise Technology

Outdoor unit fan

Outdoor unit fan design with a small separation vortex, minimized air volume by fan control, and top-class low noise

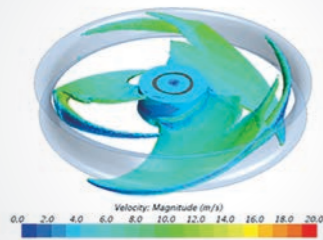

Air stabilizer in Duct

Low-noise duct structure with a built-in air stabilizer

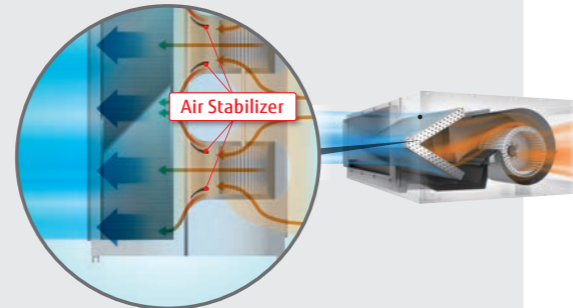

Outdoor unit low noise operation

Users can choose low noise levels, depending on the installation environment. Operation time can be set by timer.

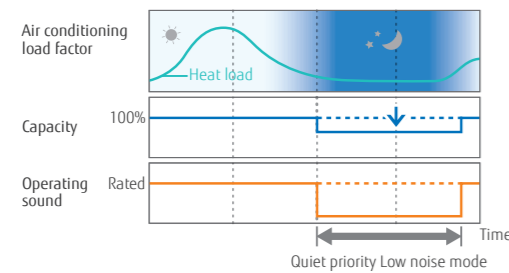

Auto changeover

In an auto setting, the system automatically switches between cooling and heating modes according to the set temperature and room temperature.

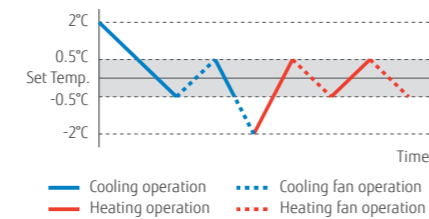

Fresh air intake for Cassette, Duct, Ceiling

Fresh air is taken in by a fan connected to an external control unit.



Feature Explanation

Energy-Saving Features

- Save Human sensor**
The Human sensor detects the movement of people in the room and determines whether to switch to energy saving operation.
- Human sensor control**
The Human sensor (option) detects movement of people in the room and decides whether to save energy or stop the unit.
- Economy operation**
The thermostat setting is adjusted automatically according to the room temperature to avoid unnecessary cooling or heating.
- Setting temperature range limitation**
Sets the minimum and maximum limits on room temperature to establish the right balance between energy saving and a comfortable environment.
- Set temperature auto return**
The setting temperature automatically returns to the previously set temperature.

Features for Comfort

- Power diffuser**
An additional louver that opens based on input from monitoring sensors to quickly enhance immediate comfort needs.
- Powerful operation**
Operation at maximum air flow and compressor speed, that quickly makes the room comfortable.
- 10°C Heat**
The room temperature can be set to go no lower than 10°C, thus ensuring that the room does not get too cold when not occupied.
- Outdoor unit low noise operation**
The noise level of the outdoor unit can be selected.
- Auto changeover**
The unit automatically switches between heating and cooling modes based on the temperature setting and the room temperature.
- UP/DOWN swing louver**
The vertical louver automatically swings up and down.
- Double swing automatic**
Complex swing action of the louver enables automatic swing in both the left/right and up/down directions.
- Automatic fan speed**
A micro-computer automatically adjusts the airflow to follow the changes in room temperature.
- Auto restart**
In the event of a temporary power failure, the air conditioner will automatically restart in the same operating mode as before, once the power supply is restored.
- Connectable fresh air duct**
Outside air can be introduced by attaching a locally purchased duct to the fresh air knockout and an optional part.
- Fresh air intake**
Fresh air can be taken in by a fan connected to an external control unit.
- Connectable distributing duct**
Locally purchased branch ducts can be attached to the systems to distribute the airflow.
- Individual airflow direction control**
Each louver of a 4-way Cassette type can be controlled individually to provide comfortable airflow.

Convenience Features

- Auto-off timer**
Automatically stops operation when a fixed time has elapsed from the start of operation.
- Sleep timer**
A micro-computer gradually changes the room temperature automatically to promote a comfortable night's sleep.
- Program timer**
This digital timer allows selection of one of four options: ON, OFF, ON + OFF, or OFF + ON.
- Weekly timer**
Different ON-OFF times can be set for each day.
- Weekly & Temperature setback timer**
Weekly & Temperature setback timer can set the temperature for 2-time spans and for each day of the week.
- Filter sign**
Indicates the filter cleaning period by blinking.
- External error output**
- External ON/OFF input**
- Wireless LAN control**
The optional WLAN adapter enables the air conditioner to be operated by smartphone or tablet PC from outside the home.
- Multi System Control**
Operation using "Lead Lag Operation", "Back up operation", "Lag Operation" is possible. (Page C-011)
- Special Cooling**
Special Cooling" is a function that supports the operation of "Multi System Control".

Clean Features

- Ion deodorization filter**
The filter deodorizes by powerfully decomposing absorbed odors using the oxidizing and reducing effects of ions generated by an ultra-fine-particle ceramic.
- Apple-catechin filter**
The Apple-catechin filter uses static electricity to clean fine particles and dust from the air.
- Long-life filter**
- Washable panel**
Since the front panel is easy to remove, maintenance is also easy.
- Silver Ion Filter**
The Silver ion filter helps to keep indoor air free from viruses, bacteria and molds.

Installation / Support

- Automatic airflow adjustment**
Automatically detects required airflow in each application case and adjusts the volume.
- Drain pump as standard**
- Blue fin**
- Refrigerant cycle monitor**
The values of each sensor and actuator can be displayed, and the status of the refrigeration cycle can be checked.



Wall-mounted type

Built-in WLAN adapter model
Designer Range
High Spec & Design

KG Series



High energy saving

Top class high efficiency is achieved by high efficient lambda-shaped heat exchanger, large cross flow fan and new refrigerant.

Rank **A+++*** SEER **9.80*** SCOP **5.20***

*07/09/12 models *07 model *07/09/12 models

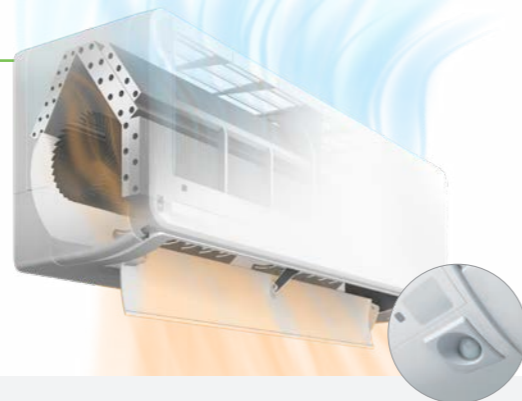

Hybrid-heat exchanger

The large hybrid heat exchanger has greatly improved the heat exchange efficiency to achieve top-level SEER and SCOP.

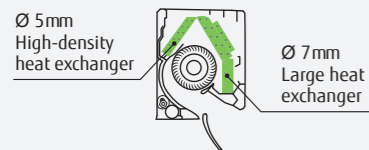

Ø107 Large cross-flow fan

The large-diameter fan generates air volume efficiently even at reduced power.

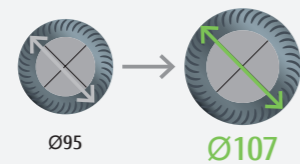

Human sensor

The Human sensor monitors the movements of people in a room and operates the air conditioner at a lower capacity when people leave the room. When people come back to the room, it automatically returns to the previous operating mode.

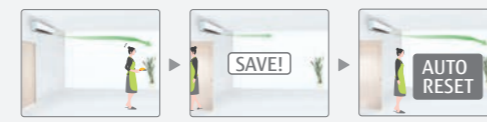

Comfortable airflow & Quiet operation

The large louver and the new air-blowing structure create a comfortable air flow that spreads all the way down to the user's feet with quiet operation.



Quiet & Comfort
19 dB(A)
(07/09/12 models)
Cooling only

Smart device control

A WLAN adapter is included as standard equipment. By installing the AIRSTAGE mobile app on your smart device, you can check and control the operating status of the air conditioner from anywhere indoors or outdoors.

* See page C-020 for details on smart device control.



Refrigerant cycle monitor (Option)

Wired Remote Controller (Touch Panel) will support to display some sensor values for maintenance and service support.

*Wired remote controller (UTY-RNRG25 or UTY-RVRG) is required.

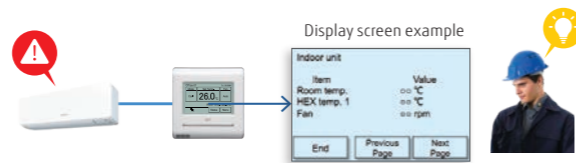

Model: ASHH07KGTG / ASHH09KGTG / ASHH12KGTG / ASHH14KGTG



Specifications

Model name	Indoor unit		ASHH07KGTG		ASHH09KGTG		ASHH12KGTG		ASHH14KGTG	
	Outdoor unit		AOHH07KGG		AOHH09KGG		AOHH12KGG		AOHH14KGG	
Power Source	Single phase, ~230 V, 50 Hz									
Capacity	Cooling	Rated	2.0		2.5		3.4		4.2	
		Min.-Max.	0.9-3.3		0.9-3.6		0.9-4.1		0.9-4.5	
	Heating	Rated	2.5		2.8		4.0		5.4	
Min.-Max.		0.9-5.2		0.9-5.4		0.9-6.1		0.9-6.4		
Input Power	Cooling/Heating		kW		0.400 / 0.500		0.550 / 0.600		0.870 / 0.910	
EER	Cooling		5.00		4.55		3.91		3.44	
	Heating		5.00		4.67		4.40		3.72	
COP	Cooling/Heating (-10°C)		kW		2.0 / 2.3		2.5 / 2.4		3.4 / 2.5	
	Cooling		W/W		9.80		9.40		8.80	
Pdesign	Cooling/Heating (Average)		kW		5.20		5.20		5.20	
	Cooling		W/W		9.80		9.40		8.80	
SEER	Cooling		W/W		5.20		5.20		4.60	
	Heating (Average)		W/W		5.20		5.20		4.60	
SCOP	Cooling		A+++		A+++		A+++		A++	
	Heating (Average)		A+++		A+++		A+++		A++	
Max. Operating Current	Cooling/Heating		A		6.5 / 9.0		6.5 / 9.0		9.0 / 10.5	
Annual Energy Consumption	Cooling		kWh/a		71		93		135	
	Heating		kWh/a		618		646		673	
Moisture Removal	Cooling		l/h		1.1		1.3		1.6	
	Heating		l/h		1.1		1.3		1.6	
Sound Pressure Level	Indoor (Cooling)	H/M/L/Q	dB(A)		36 / 32 / 29 / 19		38 / 34 / 29 / 19		40 / 35 / 30 / 19	
		Indoor (Heating)	dB(A)		38 / 34 / 31 / 20		39 / 34 / 31 / 20		42 / 38 / 33 / 21	
	Outdoor (Cooling/Heating)	High	dB(A)		42 / 43		44 / 45		50 / 50	
Sound Power Level	Indoor (Cooling/Heating)	High	dB(A)		49 / 51		52 / 52		56 / 58	
		Outdoor (Cooling/Heating)	High	dB(A)		56 / 56		58 / 58		65 / 66
	Indoor/Outdoor (Cooling)	High	dB(A)		570 / 1,390		640 / 1,480		680 / 1,800	
Airflow Rate	Indoor/Outdoor (Heating)		m³/h		610 / 1,350		630 / 1,420		750 / 1,690	
	Indoor/Outdoor (Heating)		m³/h		780 / 1,690		780 / 1,690		780 / 1,690	
Net Dimensions	Indoor		mm		270 × 834 × 215		270 × 834 × 215		270 × 834 × 215	
	Outdoor		mm		542 × 799 × 290		542 × 799 × 290		542 × 799 × 290	
Weight	Indoor		kg		10		10		10	
	Outdoor		kg		30		30		31	
Connection Pipe Diameter (Liquid/Gas)	Indoor		mm		6.35 / 9.52		6.35 / 9.52		6.35 / 9.52	
	Outdoor		mm		13.8 / 15 to 16.8		13.8 / 15 to 16.8		13.8 / 15 to 16.8	
Drain Hose Diameter (I.D./O.D.)	Indoor		mm		20 (15)		20 (15)		20 (15)	
Max. Pipe Length (Pre-Charge)	Indoor		m		15		15		15	
Max. Height Difference	Cooling		°CDB		-10 to 50		-10 to 50		-10 to 50	
	Heating		°CDB		-15 to 24		-15 to 24		-15 to 24	
Operating Range	Cooling		°CDB		-10 to 50		-10 to 50		-10 to 50	
	Heating		°CDB		-15 to 24		-15 to 24		-15 to 24	
Refrigerant	Type (Global Warming Potential)		kg (CO2eq-T)		R32 (675)		R32 (675)		R32 (675)	
	Charge		kg (CO2eq-T)		0.75 (0.506)		0.75 (0.506)		0.85 (0.574)	

Optional parts

* For optional parts compatibility of Intesis devices, please refer to the optional parts compatibility list page C-050 to C-053 and C-066.

- Wired Remote Controller (Design type): UTY-RVRG
- Compact wired remote controller: UTY-RCRG21
- Wired remote controller (touch panel): UTY-RNRG25
- Wired remote controller: UTY-RLRG
- Simple remote controller (without operation mode): UTY-RHRG
- Simple remote controller: UTY-RSRG
- External switch controller: UTY-TERX
- Communication kit: UTY-TWRXZ2
- External connect kit: UTY-XWZX
- Simple remote controller: UTY-RXRZ5
- Network Converter for single split (DC power supply type): UTY-VTGX
- Network Converter for single split (AC power supply type): UTY-VTGXV
- Silver Ion filter: UTR-FA16-5
- External input and output PCB*: UTY-XCSXZ2

*1 It is required when 2 or more external input and output ports are used.

Dimensions

(Unit: mm)

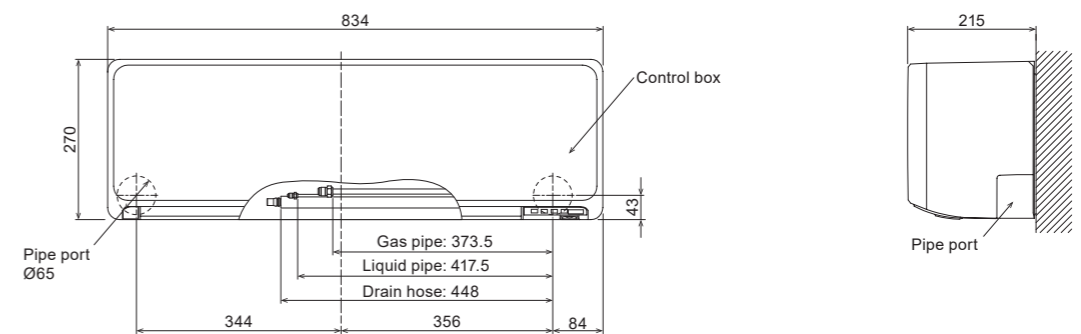

Wall-mounted type

Built-in WLAN adapter model
Designer Range
Cool Beauty Design

KE Series



Cool beauty design

We have designed this series exclusively for the European market. The exterior design harmonizes beautifully with any decor and adds comfortable elegance to the room. The light, elegant and three-dimensional expression achieved by the curved surface is beautiful from any angle.



CMF: COLOR MATERIAL FINISH

The texture of the front panel expresses the craftsmanship of Europe, and changes its expression with the changing light of the day.

High energy saving

Top class high efficiency is achieved by high efficient lambda-shaped heat exchanger, large cross flow fan and new refrigerant.

Rank Cooling*1: **A++**
Rank Heating*2: **A+**

SEER **7.4** *1
SCOP **4.4** *2

*1: 07/09 models *2: 12 model

Hybrid-heat exchanger

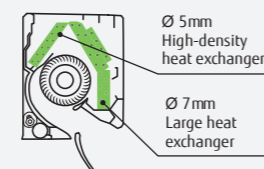

Ø107 Large cross-flow fan



Smart device control

A WLAN adapter is included as standard equipment. By installing the AIRSTAGE mobile app on your smart device, you can check and control the operating status of the air conditioner from anywhere indoors or outdoors.

* See page C-020 for details on smart device control.



Comfortable airflow & Quiet operation

The large louver and the new air-blowing structure create a comfortable air flow that spreads all the way down to the user's feet with quiet operation.



Model: ASHG07KETF / ASHG09KETF / ASHG12KETF / ASHG14KETF (Peal white X White)
ASHG07KETF-B / ASHG09KETF-B / ASHG12KETF-B / ASHG14KETF-B (Silver X Dark gray)



Specifications

Model name	Indoor unit		ASHG07KETF ASHG07KETF-B	ASHG09KETF ASHG09KETF-B	ASHG12KETF ASHG12KETF-B	ASHG14KETF ASHG14KETF-B
	Outdoor unit		AOHG07KETA	AOHG09KETA	AOHG12KETA	AOHG14KETA
Power Source	Single phase, ~230 V, 50 Hz					
Capacity	Cooling	Rated	2.0	2.5	3.4	4.2
		Min.-Max.	0.9 - 3.0	0.9 - 3.2	0.9 - 3.9	0.9 - 4.4
	Heating	Rated	2.5	2.8	4.0	5.4
		Min.-Max.	0.9 - 3.4	0.9 - 4.0	0.9 - 5.3	0.9 - 6.0
Input Power	Cooling/Heating	kW	0.450/0.555	0.630/0.620	0.935/0.960	1.220/1.410
EER	Cooling	W/W	4.43	3.97	3.65	3.44
COP	Heating	W/W	4.52	4.52	4.17	3.83
Pdesign	Cooling/Heating (-10°C)	kW	2.0/2.3	2.5/2.4	3.4/2.5	4.2/4.0
SEER	Cooling	W/W	7.40	7.30	7.30	6.90
SCOP	Heating (Average)	W/W	4.10	4.10	4.40	4.10
Energy Efficiency Class	Cooling		A++	A++	A++	A++
	Heating (Average)		A+	A+	A+	A+
Max. Operating Current	Cooling/Heating	A	6.5/9.0	6.5/9.0	6.5/9.0	6.5/9.0
Annual Energy Consumption	Cooling	kWh/a	95	118	163	213
	Heating	kWh/a	785	819	795	1,367
Moisture Removal		l/h	1.0	1.3	1.8	2.1
Sound Pressure Level	Indoor (Cooling)	H/M/L/Q	38/33/29/20	40/34/29/20	40/35/30/20	43/36/30/20
	Indoor (Heating)	H/M/L/Q	41/35/31/22	42/36/31/22	42/38/33/22	44/39/33/24
Sound Power Level	Outdoor (Cooling/Heating)	High	46/46	46/46	50/50	50/50
	Indoor (Cooling/Heating)	High	54/56	55/57	55/58	57/59
Airflow Rate	Indoor/Outdoor (Cooling)	High	650/1,650	700/1,650	700/1,700	770/1,680
	Indoor/Outdoor (Heating)	High	720/1,450	750/1,450	770/1,470	800/1,580
Net Dimensions H x W x D	Indoor	mm	295 x 950 (wall side: 840) x 230			
	Outdoor	mm	541 x 663 x 290	541 x 663 x 290	541 x 663 x 290	542 x 799 x 290
Weight	Indoor	kg	11	11	11	11.5
	Outdoor	kg	23	23	25	31
Connection Pipe Diameter (Liquid/Gas)		mm	6.35/9.52	6.35/9.52	6.35/9.52	6.35/9.52
Drain Hose Diameter (I.D./O.D.)		mm	13.8/15.0 to 16.8	13.8/15.0 to 16.8	13.8/15.0 to 16.8	13.8/15.0 to 16.8
Max. Pipe Length (Pre-Charge)		m	20 (15)	20 (15)	20 (15)	20 (15)
Max. Height Difference			15	15	15	15
Operating Range	Cooling	°CDB	-10 to 46	-10 to 46	-10 to 46	-10 to 46
	Heating	°CDB	-15 to 24	-15 to 24	-15 to 24	-15 to 24
Refrigerant	Type (Global Warming Potential)		R32 (675)	R32 (675)	R32 (675)	R32 (675)
	Charge	kg (CO2eq-T)	0.6 (0.405)	0.6 (0.405)	0.7 (0.473)	0.85 (0.574)

Optional parts

* For optional parts compatibility of Intesis devices, please refer to the optional parts compatibility list page C-050 to C-053 and C-066.

Wired Remote Controller (Design type): UTY-RVRG	Simple remote controller: UTY-RSRG	Network Converter for single split (DC power supply type): UTY-VTGX
Compact wired remote controller: UTY-RCRGZ1	Communication kit: UTY-TWRXZ2	Network Converter for single split (AC power supply type): UTY-VTGXV
Wired remote controller (touch panel): UTY-RNRGZ5	External connect kit: UTY-XWZX	Silver Ion filter: UTR-FAT6-5
Wired remote controller: UTY-RLRG	External connect kit: UTY-XWZXZ5	External input and output PCB*1: UTY-XCSXZ2
Simple remote controller (without operation mode): UTY-RHRG	External switch controller: UTY-TERX	

*1 It is required when 2 or more external input and output ports are used.

Dimensions

(Unit: mm)

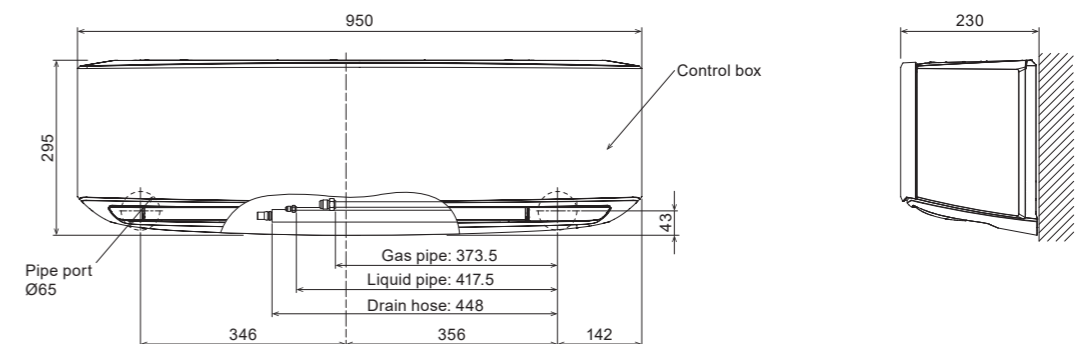

Wall-mounted type

Built-in WLAN adapter model
Standard Range
High-Efficiency & Comfort

KM Series



Slim & stylish square design

The slim and stylish square design of this indoor unit is realized by using a high-density, multipath heat exchanger and a high-efficiency wind blower.

Hybrid-heat exchanger

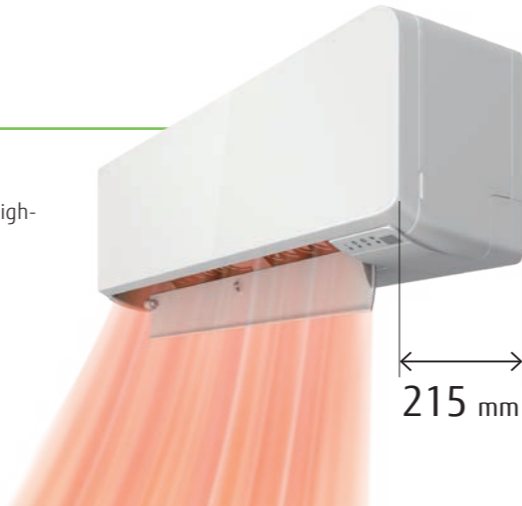
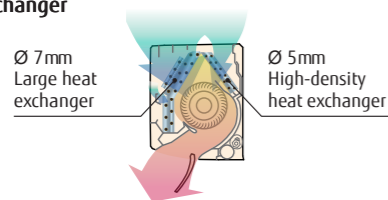

High energy saving

High-efficiency has been achieved by the lambda-shaped heat exchanger, large cross-flow fan, and the new refrigerant.

Rank Cooling A++ Heating A++*

SEER 8.40* SCOP 4.60*

*07/09/12 models

Comfortable airflow & Quiet operation

The large louver and the new air-blowing structure create a comfortable air flow that spreads all the way down to the user's feet with quiet operation.



Smart device control

A WLAN adapter is included as standard equipment. By installing the AIRSTAGE mobile app on your smart device, you can check and control the operating status of the air conditioner from anywhere indoors or outdoors.

* See page C-020 for details on smart device control.



Refrigerant cycle monitor (Option)

Wired Remote Controller (Touch Panel) will support to display some sensor values for maintenance and service support.

*Wired remote controller (UTY-RNRG25 or UTY-RVRG) is required.

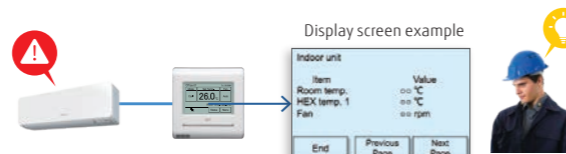

Model: ASHH07KMCG / ASHH09KMCG / ASHH12KMCG / ASHH14KMCG



Specifications

Model name	Indoor unit		ASHH07KMCG	ASHH09KMCG	ASHH12KMCG	ASHH14KMCG
	Outdoor unit		AOHH07KMCG	AOHH09KMCG	AOHH12KMCG	AOHH14KMCG
Power Source	Single phase, ~230 V, 50 Hz					
Capacity	Cooling	Rated	2.0	2.5	3.4	4.2
		Min.-Max.	0.9-3.0	0.9-3.2	0.9-3.9	0.9-4.4
	Heating	Rated	2.5	2.8	4.0	5.4
Min.-Max.		0.9-3.4	0.9-4.0	0.9-5.3	0.9-6.0	
Input Power	Cooling/Heating	kW	0.450 / 0.555	0.650 / 0.620	0.960 / 1.020	1.220 / 1.410
EER	Cooling		4.43	3.85	3.54	3.44
	Heating	W/W	4.52	4.52	3.92	3.83
Pdesign	Cooling/Heating (-10°C)	kW	2.0 / 2.3	2.5 / 2.4	3.4 / 2.5	4.2 / 4.0
SEER	Cooling		8.40	8.40	7.70	7.10
	Heating (Average)	W/W	4.60	4.60	4.60	4.10
Energy Efficiency Class	Cooling		A++	A++	A++	A++
	Heating (Average)		A++	A++	A++	A+
Max. Operating Current	Cooling/Heating	A	6.5 / 9.0	6.5 / 9.0	6.5 / 9.0	6.5 / 9.0
Annual Energy Consumption	Cooling	kWh/a	83	104	155	207
	Heating		700	730	761	1,366
Moisture Removal		l/h	1.0	1.3	1.8	2.1
	Indoor (Cooling)	H/M/L/Q	38 / 33 / 29 / 20	40 / 34 / 29 / 20	40 / 35 / 30 / 20	43 / 36 / 30 / 20
Sound Pressure Level	Indoor (Heating)	H/M/L/Q	41 / 35 / 31 / 22	42 / 36 / 31 / 22	42 / 38 / 33 / 22	44 / 39 / 33 / 24
	Outdoor (Cooling/Heating)	High	46 / 46	46 / 46	50 / 50	50 / 50
Sound Power Level	Indoor (Cooling/Heating)	High	54 / 56	55 / 57	55 / 58	57 / 59
	Outdoor (Cooling/Heating)	High	61 / 61	61 / 62	65 / 65	65 / 66
Airflow Rate	Indoor/Outdoor (Cooling)	High	650 / 1,650	700 / 1,650	700 / 1,700	770 / 1,680
	Indoor/Outdoor (Heating)	High	720 / 1,450	750 / 1,450	780 / 1,470	820 / 1,580
Net Dimensions H x W x D	Indoor	mm	270 x 834 x 215	270 x 834 x 215	270 x 834 x 215	270 x 834 x 215
	Outdoor	mm	541 x 663 x 290	541 x 663 x 290	541 x 663 x 290	542 x 799 x 290
Weight	Indoor	kg	10	10	10	10
	Outdoor	kg	22	22	24	31
Connection Pipe Diameter (Liquid/Gas)		mm	6.35 / 9.52	6.35 / 9.52	6.35 / 9.52	6.35 / 9.52
Drain Hose Diameter (I.D./O.D.)			13.8 / 15 to 16.8	13.8 / 15 to 16.8	13.8 / 15 to 16.8	13.8 / 15 to 16.8
Max. Pipe Length (Pre-Charge)		m	20 (15)	20 (15)	20 (15)	20 (15)
Max. Height Difference			15	15	15	15
	Cooling	°CDB	-10 to 50	-10 to 50	-10 to 50	-10 to 50
Operating Range	Heating		-15 to 24	-15 to 24	-15 to 24	-15 to 24
	Type (Global Warming Potential)		R32 (675)	R32 (675)	R32 (675)	R32 (675)
Refrigerant Charge		kg (CO2eq-T)	0.60 (0.405)	0.60 (0.405)	0.70 (0.473)	0.85 (0.574)

Optional parts

* For optional parts compatibility of Intesis devices, please refer to the optional parts compatibility list page C-050 to C-053 and C-066.

Wired Remote Controller (Design type): UTY-RVRG	Simple remote controller: UTY-RSRG	Network Converter for single split (DC power supply type): UTY-VTGX
Compact wired remote controller: UTY-RCRG21	Communication kit: UTY-TWRX22	Network Converter for single split (AC power supply type): UTY-VTGXV
Wired remote controller (touch panel): UTY-RNRG25	External connect kit: UTY-XWZX	Silver Ion filter: UTR-FA16-5
Wired remote controller: UTY-RLRG	External switch controller: UTY-XWZX25	External input and output PCB*: UTY-XCSX22
Simple remote controller (without operation mode): UTY-RHRG		

*1 It is required when 2 or more external input and output ports are used.

Dimensions

(Unit: mm)

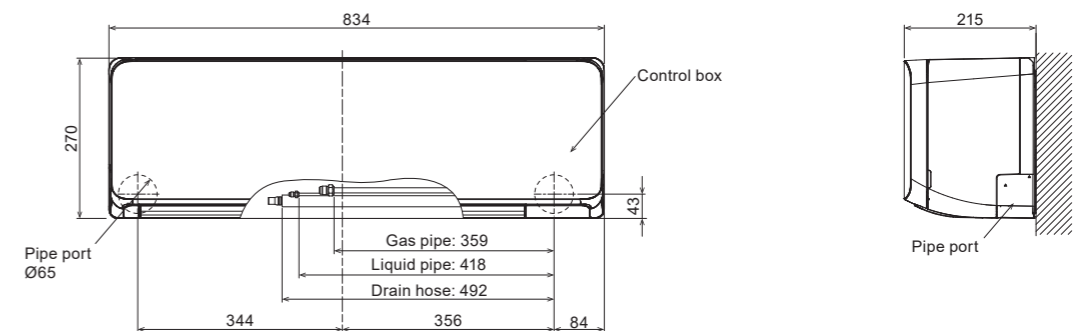

Wall-mounted type

Built-in WLAN adapter model
ECO Range
Compact Size



Elegant & smart square design

An elegant and smart type in the eco range. The delicate shading of the ridge line makes the unit an accessory for the room.



High energy saving

The size of the heat exchanger has increased to improve performance, making it more powerful despite its compact size.

Rank Cooling A++ Heating A+

SEER 7.8* SCOP 4.4

* 07 model

Comfortable airflow & Quiet operation

The large louver and the new air-blowing structure create a comfortable air flow that spreads all the way down to the user's feet with quiet operation.

Quiet & Comfort

20 dB(A)

Cooling only

Smart device control

A WLAN adapter is included as standard equipment. By installing the AIRSTAGE mobile app on your smart device, you can check and control the operating status of the air conditioner from anywhere indoors or outdoors.

* See page C-020 for details on smart device control.

AIRSTAGE Mobile

"ON" before returning home.

Highly efficient operation even at high outdoor temperatures

Even when installed in areas with high outdoor air temperatures (Max. 50°C*), it is comfortable because it can cool the interior well.

* suction temperature of the outdoor unit

Operation Range MAX 50°C (Cooling operation)

Model: ASHH07KNCA / ASHH09KNCA / ASHH12KNCA



WLAN adapter (Built-in)

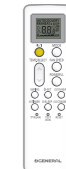

Wireless RC



Specifications

Model name	Indoor unit		ASHH07KNCA		ASHH09KNCA		ASHH12KNCA	
	Outdoor unit		AOHH07KNCA		AOHH09KNCA		AOHH12KNCA	
Power Source	Single phase, ~230 V, 50 Hz							
Capacity	Cooling	Rated	2.0		2.5		3.4	
		Min.-Max.	0.9-2.9		0.9-3.1		0.9-3.8	
	Heating	Rated	2.5		2.8		3.8	
Min.-Max.		0.9-3.4		0.9-4.0		0.9-4.8		
Input Power	Cooling/Heating		kW		0.50 / 0.58		0.74 / 0.70	
EER	Cooling		4.00		3.38		3.24	
	Heating		4.31		4.00		3.73	
Pdesign	Cooling/Heating (-10°C)		kW		2.0 / 2.3		2.5 / 2.4	
SEER	Cooling		7.8		7.4		7.0	
	Heating (Average)		4.4		4.4		4.4	
Energy Efficiency Class	Cooling		A++		A++		A++	
	Heating (Average)		A+		A+		A+	
Max. Operating Current	Cooling/Heating		A		6.5 / 9.0		6.5 / 9.0	
Annual Energy Consumption	Cooling		kWh/a		90		118	
	Heating		731		763		795	
Moisture Removal			l/h		1.0		1.0	
Sound Pressure Level	Indoor (Cooling)	H/M/L/Q	36 / 33 / 29 / 20		38 / 35 / 29 / 20		40 / 36 / 32 / 20	
	Indoor (Heating)	H/M/L/Q	38 / 33 / 30 / 22		38 / 33 / 30 / 22		39 / 35 / 31 / 22	
Sound Power Level	Outdoor (Cooling/Heating)	High	43 / 44		44 / 45		49 / 49	
	Indoor (Cooling/Heating)	High	51 / 52		53 / 52		55 / 53	
Airflow Rate	Outdoor (Cooling/Heating)	High	53 / 54		56 / 56		60 / 61	
	Indoor/Outdoor (Cooling)	High	530 / 1,430		580 / 1,430		600 / 1,460	
Net Dimensions	Indoor		mm		270 × 784 × 222		270 × 784 × 222	
	Outdoor		mm		541 × 663 × 290		541 × 663 × 290	
Weight	Indoor		kg		9		9	
	Outdoor		kg		22		24	
Connection Pipe Diameter (Liquid/Gas)			mm		6.35 / 9.52		6.35 / 9.52	
Drain Hose Diameter (I.D./O.D.)			mm		13.8 / 15 to 16.8		13.8 / 15 to 16.8	
Max. Pipe Length (Pre-Charge)			m		20 (15)		20 (15)	
Max. Height Difference			m		15		15	
Operating Range	Cooling		°CDB		-10 to 50		-10 to 50	
	Heating		-15 to 24		-15 to 24		-15 to 24	
Refrigerant	Type (Global Warming Potential)		R32 (675)		R32 (675)		R32 (675)	
	Charge		kg (CO2eq-T)		0.57 (0.385)		0.57 (0.385)	

Optional parts

* For optional parts compatibility of Intesis devices, please refer to the optional parts compatibility list page C-050 to C-053 and C-066.

Silver Ion Filter: UTR-FA16-5

Dimensions

(Unit: mm)

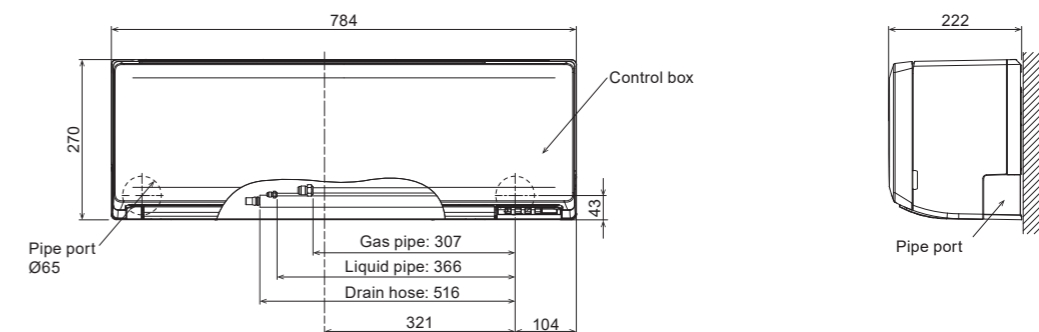

Wall-mounted type

Standard Range

High-Efficiency & Large Rooms



KM Series



High energy saving

High-efficiency has been achieved by the lambda-shaped heat exchanger, large cross-flow fan, and the new refrigerant.

Rank **A++**
SEER 7.8
SCOP 4.6
 *18 model

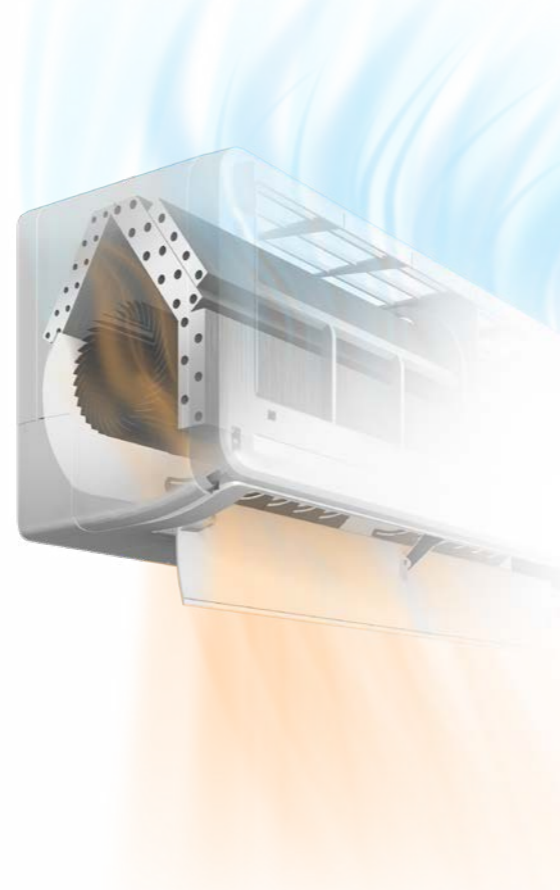

Hybrid-heat exchanger

The large hybrid heat exchanger has greatly improved the heat exchange efficiency to achieve top-level SEER and SCOP.

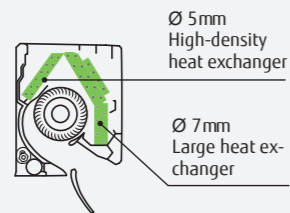

Ø107 Large cross-flow fan

The large-diameter fan generates air volume efficiently even at reduced power.

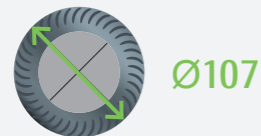

Smart device control (Option)

With the optional WLAN adapter installed in the air conditioner, you can control it from anywhere with your smart device.

* For more information about smart device control, please refer to the page C-020.



You need to install the AIRSTAGE Mobile app on your smart device in order to control the air conditioner.



Easy access to the flare pipe connection

Installation when left outlet piping is easier by removable under cover of the indoor unit chassis. Installation when center outlet piping is easier by design change of wall hook bracket.

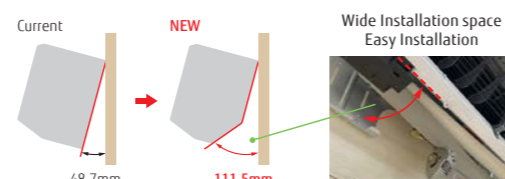

Model: ASHG18KMTE / ASHG24KMTE



Specifications

Model name	Indoor unit		ASHG18KMTE		ASHG24KMTE	
	Outdoor unit		AOHG18KMTA		AOHG24KMTA	
Power Source						
Single phase, ~230 V, 50 Hz						
Capacity	Cooling	Rated	kW	5.2	7.1	
		Min.-Max.		0.9-6.0	0.9-8.3	
	Heating	Rated	6.3	8.0		
Min.-Max.		0.9-8.7	0.9-10.1			
Input Power	Cooling/Heating		kW	1.39/1.56	2.08/1.91	
EER	Cooling			3.74	3.41	
	Heating			4.04	4.19	
Pdesign	Cooling/Heating (-10°C)		kW	5.2/4.8	7.1/7.1	
SEER	Cooling			7.77	7.30	
	Heating (Average)			4.60	4.20	
SCOP	Cooling			A++	A++	
	Heating (Average)			A++	A+	
Max. Operating Current	Cooling/Heating		A	9.5/13.5	13.5/16.0	
Annual Energy Consumption	Cooling			234	340	
	Heating			1,460	2,362	
Moisture Removal			l/h	1.7	2.7	
	Indoor (Cooling)	H/M/L/Q		45/40/35/29	49/40/35/29	
Sound Pressure Level	Indoor (Heating)	H/M/L/Q		46/40/35/29	49/40/35/29	
	Outdoor (Cooling/Heating)	High	dB(A)	50/50	54/52	
Sound Power Level	Indoor (Cooling/Heating)	High		60/61	65/65	
	Outdoor (Cooling/Heating)	High		65/65	67/66	
Airflow Rate	Indoor/Outdoor (Cooling)	High	m ³ /h	980/2,350	1,170/3,240	
	Indoor/Outdoor (Heating)	High		1,020/2,100	1,170/2,820	
Net Dimensions H x W x D	Indoor	mm		280 × 980 × 240	280 × 980 × 240	
	Outdoor	mm		632 × 799 × 290	716 × 820 × 315	
Weight	Indoor	kg		12.5	12.5	
	Outdoor	kg		36	42	
Connection Pipe Diameter (Liquid/Gas)			mm	6.35/12.70	6.35/12.70	
Drain Hose Diameter (I.D./O.D.)				13.8/15.8 to 16.7	13.8/15.8 to 16.7	
Max. Pipe Length (Pre-Charge)			m	25 (15)	30 (15)	
Max. Height Difference				20	25	
Operating Range	Cooling	°CDB		-10 to 46	-10 to 46	
	Heating			-15 to 24	-15 to 24	
Refrigerant	Type (Global Warming Potential)			R32 (675)	R32 (675)	
	Charge	kg (CO ₂ eq-T)		1.02 (0.689)	1.32 (0.891)	

Optional parts

* For optional parts compatibility of Intesis devices, please refer to the optional parts compatibility list page C-050 to C-053 and C-066.

Wired Remote Controller (Design type):	UTY-RVRG	External connect kit:	UTY-XWZX25	Network Converter for single split (DC power supply type):	UTY-VTGX
Compact wired remote controller:	UTY-RCRG21	Communication kit:	UTY-TWRXZ2	Network Converter for single split (AC power supply type):	UTY-VTGXV
Wired remote controller (touch panel):	UTY-RNRGZ5	External input and output PCB*1:	UTY-XCSXZ2	Silver Ion filter:	UTR-FA16-5
Wired remote controller:	UTY-RLRG	WLAN adapter:	UTY-TFSXF2	External switch controller:	UTY-TERX
Simple remote controller (without operation mode):	UTY-RHRG		UTY-TFSXH3		
Simple remote controller:	UTY-RSRG		FG-AC-WIF1Z1		

*1 It is required when 2 or more external input and output ports are used.

Dimensions

(Unit: mm)

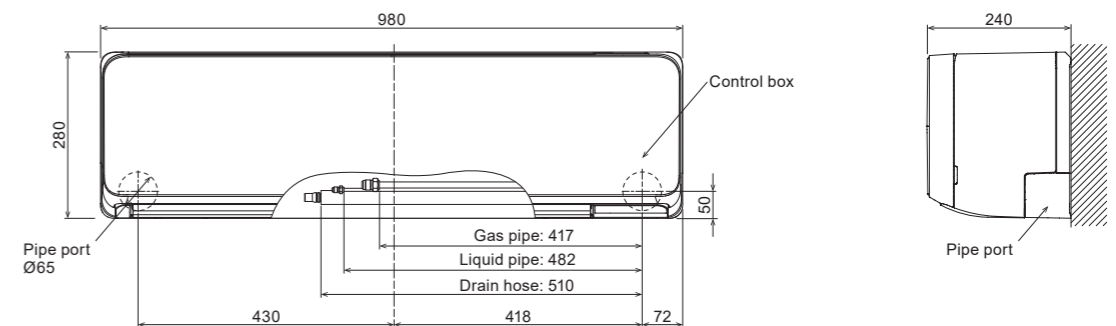

Wall-mounted type

Standard Range

High-Efficiency & Large Rooms



KM Series



Special Cooling

When it is necessary to be constantly cooled such as rooms with a high heat load, it is possible to operate the cooling with keeping performance even when the outside temperature is low.

- *Wired remote controller (UTY-RNRGZ5) is required.
- *Please note that we will not provide compensation for any damages suffered to your appliances or data as a result of using this function.
- *Please use it in low-humidity environments.
- Condensation and other problems may be caused when used in high-humidity environments.

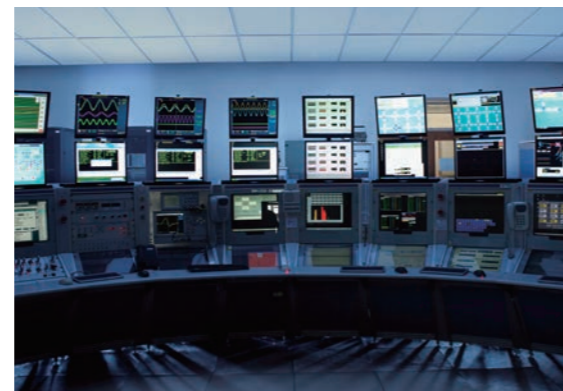

Human sensor

The Human sensor monitors the movements of people in a room and operates the air conditioner at a lower capacity when people leave the room. When people come back to the room, it automatically returns to the previous operating mode.

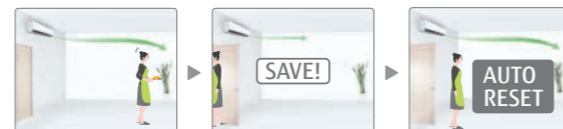

Refrigerant cycle monitor (Option)

Wired Remote Controller (Touch Panel) will support to display some sensor values for maintenance and service support.

*Wired remote controller (UTY-RNRGZ5 or UTY-RVRG) is required.

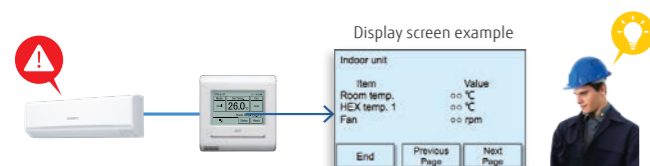

Smart device control (Option)

With the optional WLAN adapter installed in the air conditioner, you can control it from anywhere with your smart device.

* For more information about smart device control, please refer to the page C-020.



Model: ASHH30KMTB / ASHH36KMTB



Wireless RC



Specifications

Model name	Indoor unit		ASHH30KMTB		ASHH36KMTB	
	Outdoor unit		AOHH30KMTB		AOHH36KMTB	
Power Source			Single phase, ~230V, 50Hz			
Capacity	Cooling	Rated	8.0		9.4	
		Min.-Max.	2.9-9.0		2.9-10.0	
	Heating	Rated	8.8		10.1	
Min.-Max.		2.2-11.8		2.7-12.6		
Input Power	Cooling/Heating	kW	2.33/2.20		3.16/2.73	
EER	Cooling		3.43		2.97	
COP	Heating	W/W	4.00		3.70	
Pdesign	Cooling/Heating (-10°C)	kW	8.0/6.5		9.4/7.1	
SEER	Cooling	W/W	6.68		6.10	
SCOP	Heating (Average)		4.50		4.50	
Energy Efficiency Class	Cooling		A++		A++	
	Heating (Average)		A+		A+	
Max. Operating Current	Cooling/Heating	A	21.0/21.0		21.5/21.5	
Annual Energy Consumption	Cooling	kWh/a	419		534	
	Heating		1,994		2,189	
Moisture Removal			2.6		3.8	
	Indoor (Cooling)	H/M/L/Q	50/44/40/33		50/44/40/33	
Sound Pressure Level	Indoor (Heating)	H/M/L/Q	49/44/39/33		49/44/39/33	
	Outdoor (Cooling/Heating)	High	53/55		55/55	
Sound Power Level	Indoor (Cooling/Heating)	High	65/65		65/65	
	Outdoor (Cooling/Heating)	High	68/69		70/70	
Airflow Rate	Indoor/Outdoor (Cooling)	High	1,330/3,750		1,330/3,750	
	Indoor/Outdoor (Heating)	High	1,330/3,750		1,330/3,750	
Net Dimensions H x W x D	Indoor	mm	340 x 1,150 x 280		340 x 1,150 x 280	
	Outdoor	mm	788 x 940 x 320		788 x 940 x 320	
Weight	Indoor	kg	18.5		18.5	
	Outdoor	kg	52.0		52.0	
Connection Pipe Diameter (Liquid/Gas)			9.52/15.88		9.52/15.88	
Drain Hose Diameter (I.D./O.D.)			13.8/15.8 to 16.7		13.8/15.8 to 16.7	
Max. Pipe Length (Pre-Charge)			50(30)		50(30)	
Max. Height Difference			30		30	
Operating Range	Cooling	°CDB	-15to46		-15to46	
	Heating		-15to24		-15to24	
Refrigerant	Type (Global Warming Potential)		R32(675)		R32(675)	
	Charge		kg (CO2eq-T)	1.90(1.283)		1.90(1.283)

Optional parts

* For optional parts compatibility of Intesis devices, please refer to the optional parts compatibility list page C-050 to C-053 and C-066.

Wired Remote Controller (Design type):	UTY-RVRG	External connect kit:	UTY-XWZX25	Network Converter for single split (DC power supply type):	UTY-VTGX
Compact wired remote controller:	UTY-RCRGZ1	Communication kit:	UTY-TWRXZ2	Network Converter for single split (AC power supply type):	UTY-VTGXV
Wired remote controller (touch panel):	UTY-RNRGZ5	External input and output PCB*1:	UTY-XCSXZ2	Silver Ion Filter:	UTR-FA13-3
Wired remote controller:	UTY-RLRG	WLAN adapter:	UTY-TFSXF2	External switch controller:	UTY-TERX
Simple remote controller (without operation mode):	UTY-RHRG		UTY-TFSXH3		
Simple remote controller:	UTY-RSRG		FG-ACWIF1Z1		

*1 It is required when 2 or more external input and output ports are used.

Dimensions

(Unit: mm)

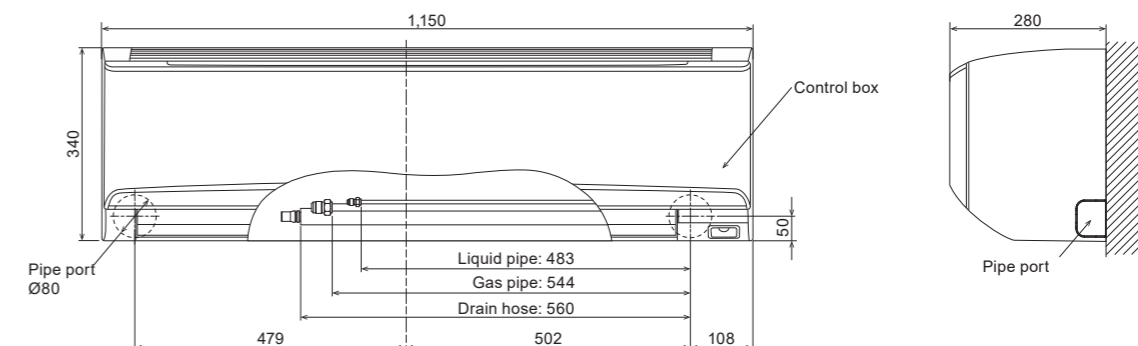

Wall-mounted type
ECO Range
Compact Size

KP Series



Slim & stylish square design

The slim and stylish square design of this indoor unit is realized by using a high-density, multipath heat exchanger and a high-efficiency wind blower.



High energy saving

High-efficiency has been achieved by the lambda-shaped heat exchanger, large cross-flow fan, and the new refrigerant.

Rank Cooling A++ Heating A+
SEER 6.7^{*1} SCOP 4.1^{*2}
*1: 07/09 models *2: 12 model

Comfortable airflow & Quiet operation

The large louver and the new air-blowing structure create a comfortable air flow that spreads all the way down to the user's feet with quiet operation.



Smart device control (Option)

With the optional WLAN adapter installed in the air conditioner, you can control it from anywhere with your smart device.

* For more information about smart device control, please refer to the page C-020.



Easy access to the flare pipe connection

Installation when left outlet piping is easier by removable under cover of the indoor unit chassis. Installation when center outlet piping is easier by design change of wall hook bracket.

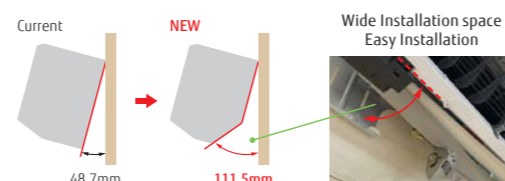

Model: ASHG07KPCE / ASHG09KPCE / ASHG12KPCE



Specifications

Model name	Indoor unit		ASHG07KPCE	ASHG09KPCE	ASHG12KPCE
	Outdoor unit		AOHG07KPCA	AOHG09KPCA	AOHG12KPCA
Power Source	Single phase, ~230 V, 50 Hz				
Capacity	Cooling	Rated	2.0	2.5	3.4
		Min.-Max.	0.9-2.8	0.9-3.0	0.9-3.7
	Heating	Rated	2.5	2.8	3.8
Min.-Max.		0.9-3.4	0.9-3.8	0.9-4.8	
Input Power	Cooling/Heating	kW	0.48/0.63	0.71/0.79	1.00/1.14
EER	Cooling		4.17	3.52	3.40
COP	Heating	W/W	3.97	3.54	3.33
Pdesign	Cooling/Heating (-10°C)	kW	2.0/2.2	2.5/2.4	3.4/2.5
SEER	Cooling	W/W	6.70	6.70	6.30
SCOP	Heating (Average)	W/W	4.00	4.00	4.10
Energy Efficiency Class	Cooling		A++	A++	A++
	Heating (Average)		A+	A+	A+
Max. Operating Current	Cooling/Heating	A	6.5/9.0	6.5/9.0	6.5/9.0
Annual Energy Consumption	Cooling	kWh/a	104	131	189
	Heating		769	840	853
Moisture Removal		l/h	1.0	1.3	1.8
Sound Pressure Level	Indoor (Cooling)	H/M/L/Q	45/38/31/22	45/38/31/22	46/40/33/22
	Indoor (Heating)	H/M/L/Q	45/40/36/26	45/40/36/26	46/40/35/27
Sound Power Level	Outdoor (Cooling/Heating)	High	45/46	47/47	49/51
	Indoor (Cooling/Heating)	High	57/58	58/58	59/59
	Outdoor (Cooling/Heating)	High	57/58	59/59	62/62
	Indoor/Outdoor (Cooling)	High	580/1,650	580/1,650	630/1,700
Airflow Rate	Indoor/Outdoor (Heating)	High	580/1,450	580/1,450	630/1,470
Net Dimensions H x W x D	Indoor	mm	270 x 784 x 224	270 x 784 x 224	270 x 784 x 224
	Outdoor	mm	541 x 663 x 290	541 x 663 x 290	541 x 663 x 290
Weight	Indoor	kg	8	8	8
	Outdoor	kg	23	23	25
Connection Pipe Diameter (Liquid/Gas)		mm	6.35/9.52	6.35/9.52	6.35/9.52
Drain Hose Diameter (I.D./O.D.)			11.8/15.0 to 16.8	11.8/15.0 to 16.8	11.8/15.0 to 16.8
Max. Pipe Length (Pre-Charge)		m	20 (15)	20 (15)	20 (15)
Max. Height Difference			15	15	15
Operating Range	Cooling	°CDB	-10 to 46	-10 to 46	-10 to 46
	Heating		-15 to 24	-15 to 24	-15 to 24
Refrigerant	Type (Global Warming Potential)		R32 (675)	R32 (675)	R32 (675)
	Charge	kg (CO2eq-T)	0.55 (0.371)	0.55 (0.371)	0.59 (0.398)

Optional parts

* For optional parts compatibility of Intesis devices, please refer to the optional parts compatibility list page C-050 to C-053 and C-066.

- WLAN adapter: UTY-TFSXF2, UTY-TFSXH3
- Silver Ion Filter: UTR-FA16-5

Dimensions

(Unit: mm)

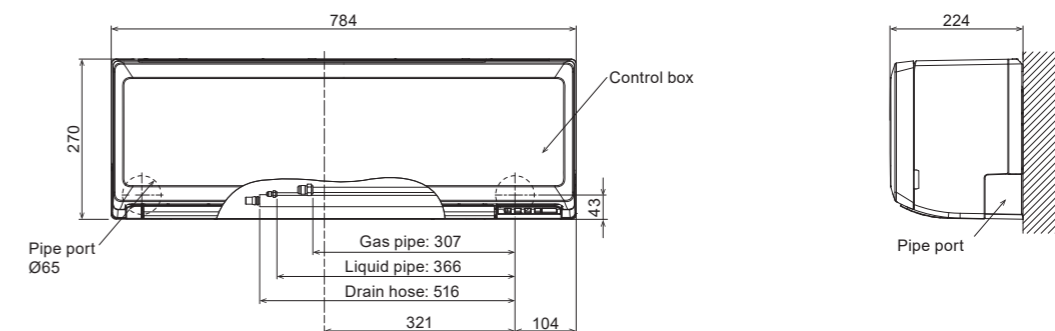

Wall-mounted type

ECO Range

Comfort for Large Rooms



KL Series



Narrow width & Compact design

Compact and versatile. Powerful airflow is realized despite the 790-mm width compact design for small spaces such as bedrooms or home offices.



Economy operation

Set temperature automatically increases or decreases by 1°C. The thermostat setting is adjusted automatically according to the room temperature to avoid unnecessary cooling or heating.

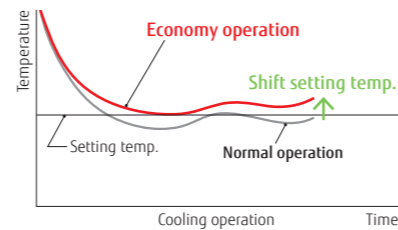

Powerful operation

In powerful operation mode, the compressor operates at maximum speed for 20 minutes to provide a powerful airflow. Rapid cooling and heating makes the room comfortable quickly.

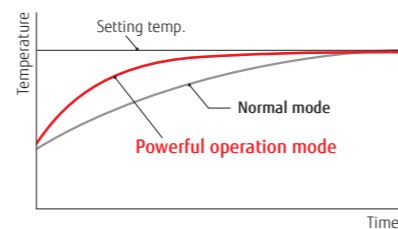

ON-OFF programmable timer

You can set ON/OFF or OFF/ON times depending on your lifestyle needs. (Setting time: 0.5, 1, 1.5, 2, 2.5, ----9.5, 10, 11, 12 hours)

Low ambient operation

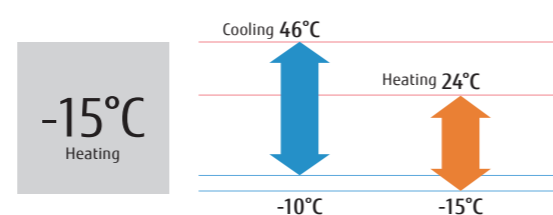

Model: ASHG18KLCA / ASHG24KLCA



Wireless RC



For ASHG18KLCA

For ASHG24KLCA

Specifications

Model name	Indoor unit		Outdoor unit		ASHG18KLCA	ASHG24KLCA
	AOHG18KLCA		AOHG24KLCA			
Power Source	Single phase, ~230 V, 50 Hz					
Capacity	Cooling	Rated	kW	5.2		7.1
		Min.-Max.		0.9-5.5		0.9-7.7
	Heating	Rated	6.3		8.0	
Min.-Max.		0.6-7.6		0.9-9.0		
Input Power	Cooling/Heating		kW	1.685/1.80		2.42/2.225
EER	Cooling			3.09		2.93
		Heating		3.50		3.60
COP	Cooling/Heating (-10°C)			5.20/4.80		7.10/7.10
		Cooling		7.20		7.10
Pdesign	Cooling			4.30		4.00
		Heating (Average)		A++		A++
SEER	Cooling			A+		A+
		Heating (Average)		9.5/13.5		13.5/17.5
SCOP	Cooling			253		350
		Heating		1563		2485
Energy Efficiency Class	Cooling			1.9		3.1
		Heating		47/44/40/35		51/45/38/33
Max. Operating Current	Cooling/Heating			50/45/41/37		52/45/41/37
		Annual Energy Consumption		50/56		55/57
Moisture Removal	Cooling/Heating			60/65		64/65
		Sound Pressure Level		61/66		65/67
Sound Power Level	Cooling/Heating			865/1,830		1,040/2,885
		Sound Power Level		995/2,265		1,040/3,030
Airflow Rate	Indoor/Outdoor (Cooling)			293 × 790 × 249		293 × 790 × 249
		Indoor/Outdoor (Heating)		542 × 799 × 290		632 × 799 × 290
Net Dimensions H x W x D	Indoor			9.5		10.0
		Outdoor		33		38
Weight	Indoor			6.35/9.52		6.35/12.70
		Outdoor		13.8/15.8 to 16.7		13.8/15.8 to 16.7
Connection Pipe Diameter (Liquid/Gas)	Cooling			25 (15)		30 (15)
		Heating		20		25
Drain Hose Diameter (I.D./O.D.)	Cooling			-10 to 46		-10 to 46
		Heating		-15 to 24		-15 to 24
Max. Pipe Length (Pre-Charge)	Cooling			R32 (675)		R32 (675)
		Heating		0.85 (0.574)		1.10 (0.743)
Max. Height Difference	Cooling					
		Heating				
Operating Range	Type (Global Warming Potential)					
		Charge				

Optional parts

* For optional parts compatibility of Intesis devices, please refer to the optional parts compatibility list page C-050 to C-053 and C-066.

Silver Ion Filter: UTR-FA16-5

Dimensions

(Unit: mm)

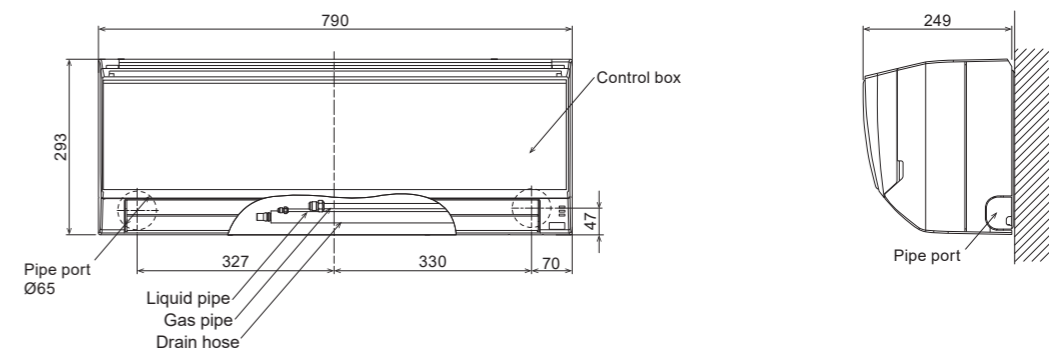

Wall-mounted type
ECO Range
Cooling-enhanced type

KL Series



Highly efficient operation even at high outdoor temperatures

Even when installed in areas with high outdoor air temperatures (Max. 52°C*), it is comfortable because it can cool the interior well.

*suction temperature of the outdoor unit

Rank **A++**
SEER **7.1***
Operation Range **MAX 52°C**
*07 model (Cooling operation)



MINIMAL SMART design

The new smart design eliminates mechanical elements and offers a sophisticated, premium impression. Its compact size, with a width of 770 mm, allows for flexible installation in limited room space.



Comfortable airflow & Quiet operation

The large louver and the new air-blowing structure create a comfortable air flow that spreads all the way down to the user's feet with quiet operation.



Smart device control (Option)

With the optional WLAN adapter installed in the air conditioner, you can control it from anywhere with your smart device.

* For more information about smart device control, please refer to the page C-020.



Model: ASHH07KLTA / ASHH09KLTA / ASHH12KLTA



Wireless RC



Specifications

Model name	Indoor unit		kW	ASHH07KLTA	ASHH09KLTA	ASHH12KLTA
	Outdoor unit			AOHH07KLTA	AOHH09KLTA	AOHH12KLTA
Power Source	Single phase, ~230 V, 50 Hz					
Capacity	Cooling	Rated		2.0	2.5	3.4
		Min.-Max.		0.9-2.8	0.9-3.0	0.9-3.7
	Heating	Rated		2.4	2.5	3.4
Min.-Max.			0.9-3.3	0.9-3.5	0.9-3.7	
Input Power	Cooling/Heating		kW	0.54 / 0.64	0.76 / 0.67	1.05 / 0.915
EER	Cooling			3.70	3.29	3.24
COP	Heating		W/W	3.75	3.73	3.72
Pdesign	Cooling/Heating (-10°C)		kW	2.0 / 2.2	2.5 / 2.3	3.4 / 2.5
SEER	Cooling		W/W	7.10	6.80	6.70
SCOP	Heating (Average)		W/W	4.10	4.10	4.10
Energy Efficiency Class	Cooling			A++	A++	A++
	Heating (Average)			A+	A+	A+
Max. Operating Current	Cooling/Heating		A	6.0 / 6.0	6.0 / 6.0	7.0 / 7.0
Annual Energy Consumption	Cooling		kWh/a	99	129	178
	Heating			752	786	854
Moisture Removal			l/h	0.18	0.55	1.26
Sound Pressure Level	Indoor (Cooling)	H/M/L/Q	dB(A)	41 / 36 / 29 / 21	43 / 36 / 29 / 21	43 / 37 / 30 / 21
	Indoor (Heating)	H/M/L/Q		41 / 37 / 32 / 23	43 / 37 / 32 / 23	43 / 37 / 32 / 23
Sound Power Level	Outdoor (Cooling/Heating)	High	dB(A)	47 / 47	47 / 47	50 / 50
	Indoor (Cooling/Heating)	High		54 / 55	55 / 55	55 / 56
Airflow Rate	Indoor/Outdoor (Cooling)	High	m³/h	600 / 1,650	620 / 1,650	620 / 1,700
	Indoor/Outdoor (Heating)	High		600 / 1,450	620 / 1,450	640 / 1,470
Net Dimensions H x W x D	Indoor	mm		250 x 770 x 218	250 x 770 x 218	250 x 770 x 218
	Outdoor	mm		541 x 663 x 290	541 x 663 x 290	541 x 663 x 290
Weight	Indoor	kg		7.0	7.0	7.5
	Outdoor	kg		19	19	22
Connection Pipe Diameter (Liquid/Gas)			mm	6.35 / 9.52	6.35 / 9.52	6.35 / 9.52
Drain Hose Diameter (I.D./O.D.)			mm	13.8 / 15 to 16.8	13.8 / 15 to 16.8	13.8 / 15 to 16.8
Max. Pipe Length (Pre-Charge)			m	20 (15)	20 (15)	20 (15)
Max. Height Difference				15	15	15
Operating Range	Cooling		°CDB	10 to 52	10 to 52	10 to 52
	Heating			-15 to 24	-15 to 24	-15 to 24
Refrigerant	Type (Global Warming Potential)		kg (CO2eq-T)	R32 (675)	R32 (675)	R32 (675)
	Charge			0.53(0.358)	0.53(0.358)	0.60(0.405)

Optional parts

* For optional parts compatibility of Intesis devices, please refer to the optional parts compatibility list page C-050 to C-053 and C-066.

WLAN adapter: UTY-TFSXF2

UTY-TFSXH3

Silver Ion Filter: UTR-FA16-5

Dimensions

(Unit: mm)

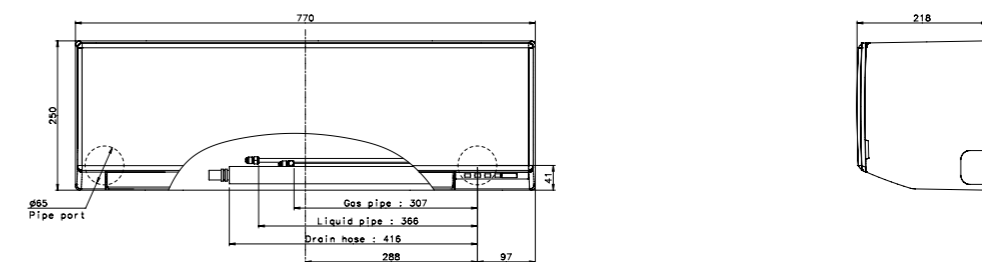

Compact Cassette

Compact 4-way Flow Range
Compact Size



Compact and stylish panel design

The compact and stylish panel fits nicely into a grid-type ceiling. Its linear design is a perfect fit into a grid of 620 mm × 620 mm in the ceiling.



Easy maintenance

You can access the unit for maintenance simply by removing a ceiling panel next to the grille. As no inspection hole needs to be cut through the ceiling, no additional construction cost is incurred.

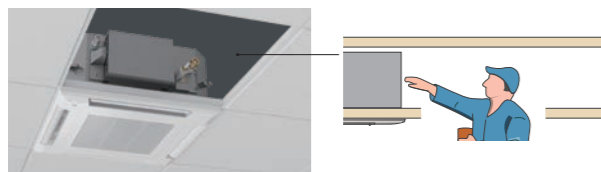

The air inlet grille can be installed to open in any direction for easy maintenance.



Flexible installation

The unit fits nicely into the decor of a grid-type ceiling and can be installed near the lighting or a ventilation opening.



Link up with a variety of central control system (Option)

Centralized control including facilities and equipment in addition to air conditioning is possible by linking up with MODBUS, KNX interfaces.



Model: AUXG09KVLA / AUXG12KVLA / AUXG14KVLA / AUXG18KVLA / AUXG22KVLA / AUXG24KVLA



Specifications

Model name	Indoor unit		AUXG09KVLA	AUXG12KVLA	AUXG14KVLA	AUXG18KVLA	AUXG22KVLA	AUXG24KVLA
	Outdoor unit		AOHG09KBTB	AOHG12KBTB	AOHG14KBTB	AOHG18KBTB	AOHG22KBTB	AOHG24KBTB
Power Source			Single phase, ~230 V, 50 Hz					
Capacity	Cooling	Rated	2.5	3.5	4.3	5.2	6.0	6.8
		Min.-Max.	0.9-3.2	0.9-4.4	0.9-5.4	0.9-5.9	0.9-6.7	0.9-8.0
	Heating	Rated	3.2	4.1	5.0	6.0	7.0	7.5
Min.-Max.		0.9-4.7	0.9-5.7	0.9-6.5	0.9-7.5	0.9-8.0	0.9-9.1	
EER	Cooling/Heating	kW	0.55/0.79	0.93/1.08	1.28/1.32	1.60/1.66	1.82/1.87	2.21/2.03
COP	Cooling	W/W	4.57	3.76	3.36	3.25	3.30	3.08
	Heating	W/W	4.05	3.80	3.79	3.61	3.74	3.69
Pdesign	Cooling/Heating (-10°C)	kW	2.5/2.6	3.5/3.4	4.3/3.8	5.2/4.4	6.0/4.8	6.8/6.0
SEER	Cooling	W/W	6.70	6.60	6.50	6.60	6.60	6.10
	Heating (Average)	W/W	4.40	4.30	4.40	4.20	4.30	4.00
Energy Efficiency Class	Cooling		A++	A++	A++	A++	A++	A++
	Heating (Average)		A+	A+	A+	A+	A+	A+
Max. Operating Current	Cooling/Heating	A	7.9/7.9	9.7/9.7	10.2/10.2	12.1/12.1	12.6/12.6	13.6/13.6
Annual Energy Consumption	Cooling	kWh/a	131	186	231	275	318	390
	Heating	kWh/a	826	1,106	1,208	1,466	1,562	2,097
Moisture Removal		l/h	0.6	1.2	1.5	2.2	2.6	2.7
Sound Pressure Level	Indoor (Cooling)	H/M/L/Q	33/31/29/27	37/34/30/27	38/34/30/27	38/34/30/26	44/42/36/30	49/44/36/30
	Indoor (Heating)	H/M/L/Q	34/32/29/27	37/34/31/29	43/38/34/30	43/38/34/30	45/43/40/33	49/45/40/33
Sound Power Level	Outdoor (Cooling/Heating)	High	46/46	47/47	49/49	50/50	51/51	53/54
	Indoor (Cooling/Heating)	High	46/47	49/49	50/55	50/55	56/57	59/61
	Outdoor (Cooling/Heating)	High	59/59	61/61	62/62	62/62	63/63	65/66
	Indoor/Outdoor (Cooling)	High	540/1,480	600/1,580	680/1,670	680/2,160	830/2,240	930/2,700
Airflow Rate	Indoor/Outdoor (Heating)	High	540/1,410	600/1,520	800/1,580	800/1,830	860/1,960	930/2,700
Net Dimensions H x W x D	Indoor	mm	245 × 570 × 570	245 × 570 × 570	245 × 570 × 570	245 × 570 × 570	245 × 570 × 570	245 × 570 × 570
	Outdoor	mm	542 × 799 × 290	542 × 799 × 290	542 × 799 × 290	632 × 799 × 290	632 × 799 × 290	716 × 820 × 315
Weight	Indoor	kg	15	15	15	15	16	16
	Outdoor	kg	32	33	33	36	38	42
Connection Pipe Diameter (Liquid/Gas)		mm	6.35/9.52	6.35/9.52	6.35/9.52	6.35/12.70	6.35/12.70	6.35/12.70
Drain Hose Diameter (I.D./O.D.)		mm	25/32	25/32	25/32	25/32	25/32	25/32
Max. Pipe Length (Pre-Charge)		m	20 (15)	25 (15)	25 (15)	30 (20)	30 (20)	30 (20)
Max. Height Difference			15	20	20	20	25	25
Operating Range	Cooling	°CDB	-15 to 46	-15 to 46	-15 to 46	-15 to 46	-15 to 46	-15 to 46
	Heating	°CDB	-15 to 24	-15 to 24	-15 to 24	-15 to 24	-15 to 24	-15 to 24
Refrigerant	Type (Global Warming Potential)		R32 (675)	R32 (675)	R32 (675)	R32 (675)	R32 (675)	R32 (675)
	Charge	kg (CO2eq-T)	0.85 (0.574)	0.85 (0.574)	0.85 (0.574)	1.02 (0.689)	1.25 (0.844)	1.25 (0.844)
Cassette Grille	Model name		UTG-UFGF-W	UTG-UFGF-W	UTG-UFGF-W	UTG-UFGF-W	UTG-UFGF-W	UTG-UFGF-W
	Dimensions (H × W × D)	mm	49 × 620 × 620	49 × 620 × 620	49 × 620 × 620	49 × 620 × 620	49 × 620 × 620	49 × 620 × 620
	Weight	kg	2.3	2.3	2.3	2.3	2.3	2.3

Optional parts

* For optional parts compatibility of Intesis devices, please refer to the optional parts compatibility list page C-050 to C-053 and C-066.

Wired Remote Controller (Design type): UTY-RVRG	Wireless remote controller: UTY-LNTG	Network Converter for single split (DC power supply type): UTY-VTGX
Compact wired remote controller: UTY-RRCRZ1	External switch controller: UTY-TERX	Network Converter for single split (AC power supply type): UTY-VTGXV
Wired remote controller (touch panel): UTY-RNRGZ5	WLAN adapter: UTY-TFSXZ1	Insulation kit for high humidity: UTZ-KXGC
Wired remote controller: UTY-RLRG	FG-RC-WIF1Z2	External input and output PCB: UTY-XCSX
UTY-RNNGM	UTY-TFSXJ3	External input and output PCB box: UTZ-GXRA
UTY-RVNGM	FG-AC-WIF1Z1	Silver Ion Filter: UTD-HFAA
Simple remote controller (without operation mode): UTY-RHRG	Air Outlet Shutter Plate: UTR-YDZB	Fresh air intake kit: UTZ-VXAA
Simple remote controller: UTY-RSRG	Cassette Grille: UTG-UFGF-W	External connect kit: UTY-XWZXG

Dimensions

(Unit: mm)

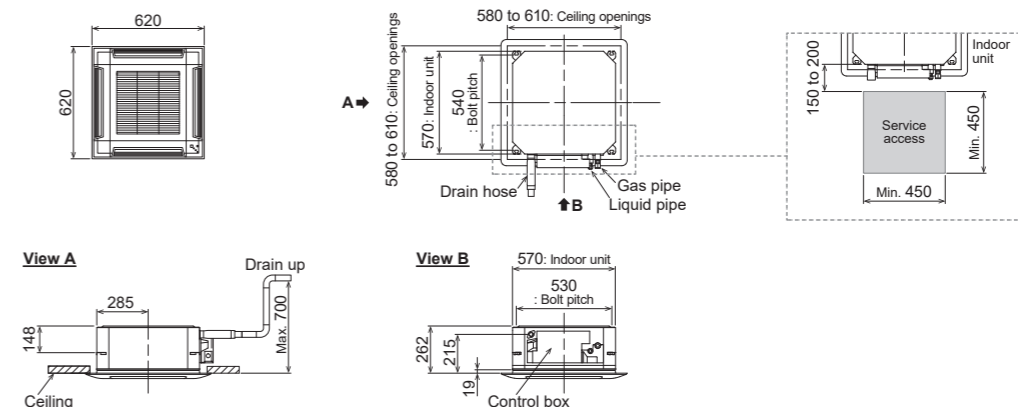

Cassette

Circular Flow Range

Comfort for Large Rooms

UTG-UKGA-B
Black Grille



Unique circular flow design

The Cassette model realizes a Circular Flow to blow a large airflow in a 360° direction by using a high-performance DC fan motor, turbo fan, and a unique seamless airflow louver design.



Airflows avoid blowing cool air directly at the occupants in the room, providing more comfortable air conditioning. Provides efficient air conditioning based on the room layout

Individual louver control

Each louver can be controlled individually with a wired remote controller equipped with a touch panel to provide different directional airflows according to the room layout.

*Wired remote controller (touch panel) (UTY-RNRGZ3) only

The Human sensor yields more energy savings.
Energy saving operation starts automatically by detecting the motion of a person. Two modes of save operation mode and stop mode can be selected.

Compact and lightweight outdoor unit

The outdoor units for the 45,000 BTU and 54,000 BTU models have been completely redesigned. Easier installation is achieved for this compact and lightweight outdoor unit.

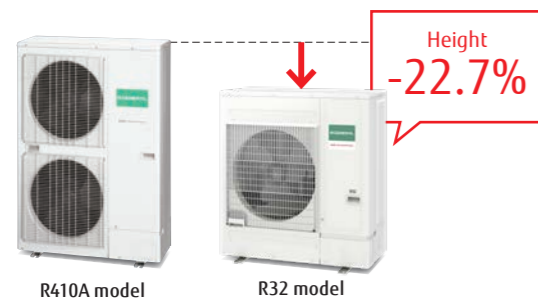

Various cassette grilles

Both black and white grilles are available. Three types of grilles are available: a white grille with a remote controller; a white grille without a remote controller; and a black grille without a remote controller. Select to match the atmosphere and/or usage of the room.



Link up with a variety of central control system (Option)

Centralized control including facilities and equipment in addition to air conditioning is possible by linking up with MODBUS, KNX interfaces.



Model: AUXG18KRLB / AUXG22KRLB / AUXG24KRLB / AUXG30KRLB / AUXG36KRLB / AUXG45KRLB / AUXG54KRLB
AUXG36KRLB [3-phase] / AUXG45KRLB [3-phase] / AUXG54KRLB [3-phase]



Specifications

Model name	Indoor unit								AUXG18KRLB			AUXG22KRLB			AUXG24KRLB			AUXG30KRLB			AUXG36KRLB			AUXG45KRLB			AUXG54KRLB		
	Outdoor unit								AOHG18KRTB			AOHG22KRTB			AOHG24KRTB			AOHG30KRTB			AOHG36KRTB			AOHG45KRTB			AOHG54KRTB		
Power Source	Single phase, ~230 V, 50 Hz																												
Capacity	Cooling	Rated	kW																										
		Min.-Max.	5.2 6.0 6.8 8.5 9.5 12.1 13.4 9.5 12.1 13.4																										
	Heating	Rated	0.9-5.9 0.9-6.7 0.9-8.0 2.8-10.0 2.8-11.2 4.0-14.0 4.5-14.5 2.8-11.2 4.0-14.0 4.5-14.5																										
		Min.-Max.	6.0 7.0 7.5 10.0 10.8 13.5 15.5 10.8 13.5 15.5																										
Input Power	Cooling/Heating	kW																											
EER	Cooling	W/W																											
COP	Heating	W/W																											
Pdesign	Cooling/Heating (-10°C)	kW																											
SEER	Cooling	W/W																											
SCOP	Heating (Average)	W/W																											
Energy Efficiency Class	Cooling	A+ A+ A+ A+ A+ - - A+ - -																											
	Heating (Average)	A+ A+ A+ A+ A+ - - A+ - -																											
Max. Operating Current	Cooling/Heating	A																											
Annual Energy Consumption	Cooling	kWh/a																											
	Heating	kWh/a																											
Moisture Removal		l/h																											
Sound Pressure Level	Indoor (Cooling)	H/M/L/Q	dB(A)																										
	Indoor (Heating)	H/M/L/Q	dB(A)																										
	Outdoor (Cooling/Heating)	High	dB(A)																										
	Outdoor (Cooling/Heating)	High	dB(A)																										
Sound Power Level	Indoor (Cooling/Heating)	High	dB(A)																										
	Outdoor (Cooling/Heating)	High	dB(A)																										
	Indoor (Cooling/Heating)	High	dB(A)																										
	Outdoor (Cooling/Heating)	High	dB(A)																										
Airflow Rate	Indoor/Outdoor (Cooling)	High	m³/h																										
	Indoor/Outdoor (Heating)	High	m³/h																										
Net Dimensions H x W x D	Indoor	mm																											
	Outdoor	mm																											
Weight	Indoor	kg																											
	Outdoor	kg																											
Connection Pipe Diameter (Liquid/Gas)		mm																											
Drain Hose Diameter (I.D./O.D.)		mm																											
Max. Pipe Length (Pre-Charge)		m																											
Max. Height Difference		m																											
Operating Range	Cooling	°CDB																											
	Heating	°CDB																											
Refrigerant	Type (Global Warming Potential)	R32 (675)																											
	Charge	kg (CO2eq-T)																											
Cassette Grille	Variation	UTG-UKGA-W: White wired remote controller (touch panel) UTG-UKGC-W: White/UTG-UKGA-B*: Black UTG-UKGC-W: White/UTG-UKGA-B*: Black																											
	Dimensions (H x W x D)	mm																											
	Weight	kg																											

*1: IR Receiver kit and Human sensor kit cannot be connected.

Optional parts

*For optional parts compatibility of Intesis devices, please refer to the optional parts compatibility list page C-050 to C-053 and C-066.

Wired Remote Controller (Design type):	UTY-RVRG	WLAN adapter:	UTY-TFSXZ1	Cassette Grille:	UTG-UKGA-B
Compact wired remote controller:	UTY-RCRGZ1		FG-RC-WIF1Z2		UTG-UKGA-W
Wired remote controller (touch panel):	UTY-RNRGZ5		UTY-TFSXJ3		UTG-UKGC-W
Wired remote controller:	UTY-RLRG		FG-AC-WIF1Z1	Network Converter for single split (DC power supply type):	UTY-VTGX
	UTY-RNNGM		UTY-XCSX	Network Converter for single split (AC power supply type):	UTY-VTGVV
	UTY-RVNGM	External input and output PCB box:	UTZ-GXRA	Silver Ion Filter:	UTD-HFRA
Simple remote controller (without operation mode):	UTY-RHRG	Insulation kit for high humidity:	UTZ-KXRA	External connect kit:	UTY-XWZXZG
Simple remote controller:	UTY-RSRG	Fresh air intake kit:	UTZ-VXRA		
Human sensor kit:	UTY-SHZXC	Wide Panel:	UTG-AKXA-W	(Outdoor unit 30/36/45/54)	
External switch controller:	UTY-TERX	Panel Spacer:	UTG-BKXA-W	External connect kit:	UTY-XWZXZ3
IR receiver unit	UTY-LBTGC	Air Outlet Shutter Plate:	UTR-YDZK		

Dimensions

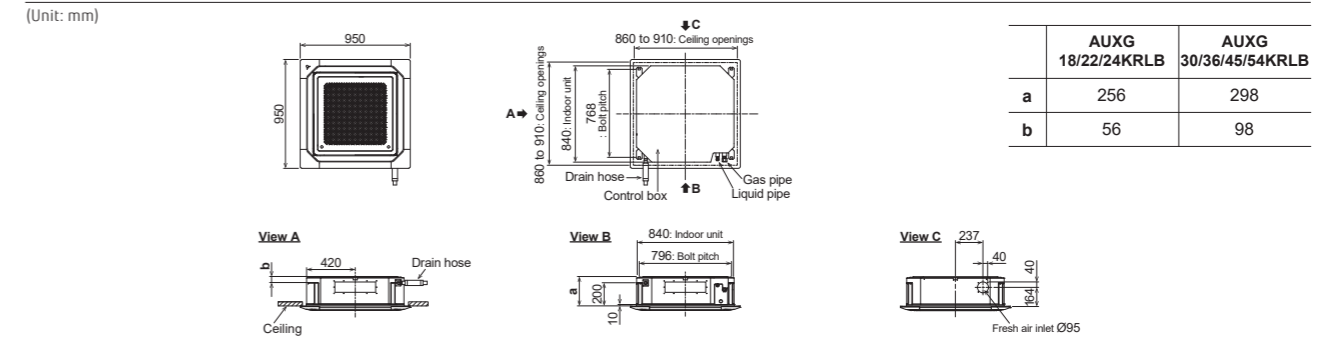

Slim Duct

Slim Design



Slim design

The slim design fits nicely into narrow spaces under the ceiling. Drain hose as standard accessory



Compact and lightweight outdoor unit

The compact and lightweight outdoor unit offers greater flexibility in the choice of installation location. This makes it easier to use this outdoor unit.

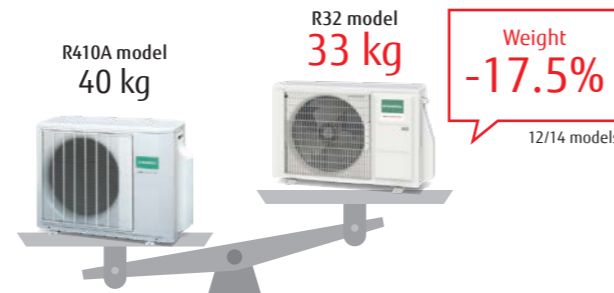

Wide range of static pressures

The use of a DC fan motor makes it possible to adjust the static pressure between 0 and 90 Pa. The static pressure range can be changed by a remote controller.



Static pressure range
0 to 90 Pa

Auto louver grille kit (Option)

The optional clean-looking flat Auto louver blends into any interior and provides a comfortable airflow.



Link up with a variety of central control system (Option)

Centralized control including facilities and equipment in addition to air conditioning is possible by linking up with MODBUS, KNX interfaces.



Model: ARXG09KLLAP / ARXG12KLLAP / ARXG14KLLAP / ARXG18KLLAP

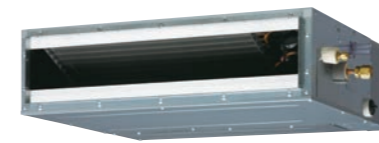

ARXG09/12/14KLLAP

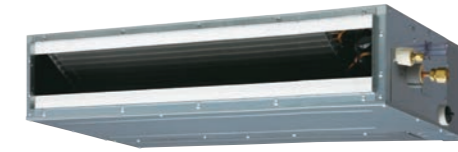

ARXG18KLLAP



For ARXG09/12/14KLLAP For ARXG18KLLAP

Specifications

Model name	Indoor unit		ARXG09KLLAP	ARXG12KLLAP	ARXG14KLLAP	ARXG18KLLAP
	Outdoor unit		AOHG09KBTB	AOHG12KBTB	AOHG14KBTB	AOHG18KBTB
Power Source	Single phase, ~230 V, 50 Hz					
Capacity	Cooling	Rated	2.5	3.5	4.3	5.2
		Min.-Max.	0.9-3.2	0.9-4.4	0.9-5.4	0.9-5.9
	Heating	Rated	3.2	4.1	5.0	6.0
Min.-Max.		0.9-4.7	0.9-5.7	0.9-6.5	0.9-7.5	
Input Power	Cooling/Heating	kW	0.60/0.79	0.93/1.08	1.28/1.32	1.55/1.62
EER	Cooling	W/W	4.17	3.76	3.36	3.35
COP	Heating	W/W	4.05	3.80	3.79	3.70
Pdesign	Cooling/Heating (-10°C)	kW	2.5/2.6	3.5/3.4	4.3/3.8	5.2/4.4
SEER	Cooling	W/W	6.20	6.10	5.80	6.20
SCOP	Heating	W/W	4.30	4.00	3.90	4.10
Energy Efficiency Class	Cooling		A++	A++	A+	A++
	Heating		A+	A+	A	A+
Max. Operating Current	Cooling/Heating	A	7.9/7.9	9.7/9.7	10.2/10.2	12.1/12.1
Annual Energy Consumption	Cooling	kWh/a	141	201	259	293
	Heating	kWh/a	845	1,189	1,362	1,501
Moisture Removal		l/h	0.7	1.3	1.5	2.0
Sound Pressure Level	Indoor (Cooling)	H/M/L/Q	28/27/26/25	29/28/26/25	32/30/28/26	32/30/29/27
	Indoor (Heating)	H/M/L/Q	28/26/25/24	29/28/26/24	32/30/28/25	32/30/29/27
Sound Power Level	Outdoor (Cooling/Heating)	High	46/46	47/47	49/49	50/50
	Indoor (Cooling/Heating)	High	57/57	58/58	60/60	58/58
Airflow Rate	Indoor/Outdoor (Cooling)	High	600/1,480	650/1,580	800/1,670	940/2,160
	Indoor/Outdoor (Heating)	High	600/1,410	650/1,520	800/1,580	940/1,830
Static pressure range (Standard)		Pa	0 to 90 (25)	0 to 90 (25)	0 to 90 (25)	0 to 90 (25)
Net Dimensions H x W x D	Indoor	mm	198 x 700 x 620	198 x 700 x 620	198 x 700 x 620	198 x 900 x 620
	Outdoor	mm	542 x 799 x 290	542 x 799 x 290	542 x 799 x 290	632 x 799 x 290
Weight	Indoor	kg	17	17	17	20
	Outdoor	kg	32	33	33	36
Connection Pipe Diameter (Liquid/Gas)		mm	6.35/9.52	6.35/9.52	6.35/9.52	6.35/12.70
Drain Hose Diameter (I.D./O.D.)		mm	25/32	25/32	25/32	25/32
Max. Pipe Length (Pre-Charge)		m	20 (15)	25 (15)	25 (15)	30 (20)
Max. Height Difference			15	20	20	20
Operating Range	Cooling	°CDB	-15 to 46	-15 to 46	-15 to 46	-15 to 46
	Heating	°CDB	-15 to 24	-15 to 24	-15 to 24	-15 to 24
Refrigerant	Type (Global Warming Potential)		R32 (675)	R32 (675)	R32 (675)	R32 (675)
	Charge	kg (CO2eq-T)	0.85 (0.574)	0.85 (0.574)	0.85 (0.574)	1.02 (0.689)

Optional parts

* For optional parts compatibility of Intesis devices, please refer to the optional parts compatibility list page C-050 to C-053 and C-066.

Wired Remote Controller (Design type):	UTY-RVRG	WLAN adapter:	UTY-TFSXZ1	Network Converter for single split (DC power supply type):	UTY-VTGX
Compact wired remote controller:	UTY-RCRGZ1		FG-RC-WIF122	Network Converter for single split (AC power supply type):	UTY-VTGXV
Wired remote controller (touch panel):	UTY-RNRGZ5		UTY-TFSXJ3	External connect kit:	UTY-XWZXZG
Wired remote controller:	UTY-RLRG	Silver Ion Filter:	FG-AC-WIF121	Remote sensor unit:	UTY-XSZXZ1
	UTY-RNNGM		UTD-HFTA (09-14)	Auto Louver Grille Kit:	UTD-GXTA-W (09-14)
	UTY-RVNGM		UTD-HFTB (18)		UTD-GXTB-W (18)
Simple remote controller (without operation mode):	UTY-RHRG	External switch controller:	UTY-TERX		
Simple remote controller:	UTY-RSRG	IR receiver unit:	UTY-LBTGM		

Dimensions

(Unit: mm)

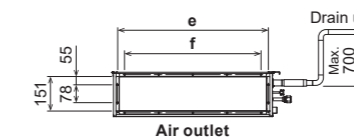
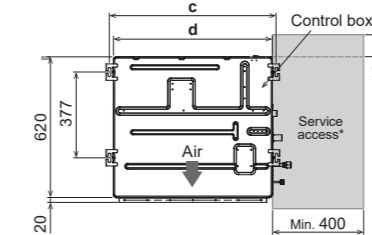
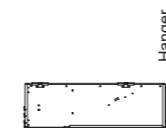
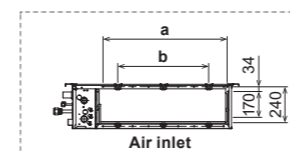

	ARXG 09 / 12 / 14KLLAP	ARXG18KLLAP
a	574	774
b	P200×2=400	P200×3=600
c	734	934
d	700	900
e	650	850
f	P100×6=600	P100×8=800

*The design of the service access depends on the installation method. Refer to the installation manual for more information.

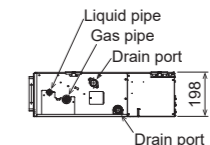

Medium Static Pressure Duct

High-Efficiency & Comfort



Slim & Compact design

The new product has reduced the height to 240 mm, making it more compact. The slim design fits nicely into narrow spaces under the ceiling.

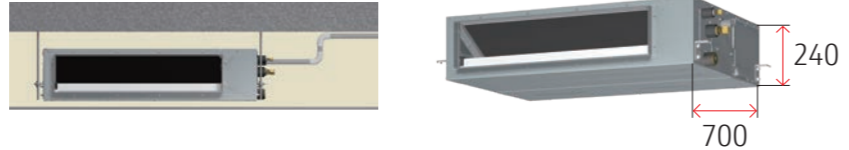

High energy saving

The new model has achieved high energy efficiency rank with a compact design.

Rank Cooling A++ Heating A+

SEER 6.50*1 SCOP 4.20*2

*1: 12/22 models *2: 12/22/24 models

Easy maintenance

The indoor units have large panels on both sides providing easy maintenance in narrow spaces.

- Easy inspection of drain hose:** The whole drain hose can be removed for easy replacement and cleaning.
- Easy cleaning of the heat exchanger:** Filter can be installed and removed easily. *Long life filter is available as optional parts.
- Filter change:** Filter can be installed and removed easily. *Long life filter is available as optional parts.

Drain hose as standard

A drain hose is a standard accessory, making it easy to design drainage even in narrow spaces under the ceiling.



Wide range of static pressures

Static pressures can be changed in the range of 30 to 150 Pa.

Static pressure range **30 to 150 Pa**

Model: ARXH12KMTAP / ARXH14KMTAP / ARXH18KMTAP / ARXH22KMTAP / ARXH24KMTAP



Specifications

Model name	Indoor unit		ARXH12KMTAP	ARXH14KMTAP	ARXH18KMTAP	ARXH22KMTAP	ARXH24KMTAP
	Outdoor unit		AOHG12KBTB	AOHG14KBTB	AOHG18KBTB	AOHG22KBTB	AOHG24KBTB
Power Source	Single phase, ~230 V, 50 Hz						
Capacity	Cooling	Rated	3.5	4.3	5.2	6.0	6.8
		Min.-Max.	0.9-4.4	0.9-5.4	0.9-5.9	0.9-6.7	0.9-8.0
	Heating	Rated	4.1	5.0	6.0	7.0	7.5
Min.-Max.		0.9-5.7	0.9-6.5	0.9-7.5	0.9-8.0	0.9-9.1	
Input Power	Cooling/Heating	kW	0.930 / 1.080	1.260 / 1.320	1.580 / 1.740	1.67 / 1.84	1.89 / 1.87
EER	Cooling	W/W	3.76	3.40	3.30	3.60	3.60
COP	Heating	W/W	3.80	3.79	3.45	3.80	4.01
Pdesign	Cooling/Heating (-10°C)	kW	3.5 / 3.4	4.3 / 3.8	5.2 / 4.4	6.0 / 4.8	6.8 / 6.0
SEER	Cooling	W/W	6.50	6.10	6.20	6.50	6.40
SCOP	Heating (Average)	W/W	4.20	4.00	4.10	4.20	4.20
Energy Efficiency Class	Cooling		A++	A++	A++	A++	A++
	Heating (Average)		A+	A+	A+	A+	A+
Max. Operating Current	Cooling/Heating	A	9.7 / 9.7	10.2 / 10.2	12.1 / 12.1	12.6 / 12.6	13.6 / 13.6
Annual Energy Consumption	Cooling	kWh/a	196	255	301	331	380
	Heating	kWh/a	1,133	1,330	1,501	1,598	1,999
Moisture Removal		l/h	1.3	1.3	2.0	1.5	2.2
Sound Pressure Level	Indoor (Cooling)	H/M/L/Q	29 / 27 / 25 / 23	32 / 29 / 27 / 25	33 / 30 / 28 / 26	32 / 28 / 25 / 24	34 / 30 / 28 / 26
	Indoor (Heating)	H/M/L/Q	29 / 27 / 25 / 23	32 / 29 / 27 / 25	33 / 30 / 28 / 26	32 / 28 / 25 / 24	34 / 30 / 28 / 26
Sound Power Level	Outdoor (Cooling/Heating)	High	47 / 47	49 / 49	50 / 50	51 / 51	53 / 54
	Indoor (Cooling/Heating)	High	58 / 58	59 / 59	60 / 60	58 / 58	60 / 60
Airflow Rate	Indoor (Cooling/Heating)	High	61 / 61	62 / 62	62 / 62	63 / 63	65 / 66
	Indoor/Outdoor (Cooling)	High	650 / 1,580	800 / 1,670	840 / 2,160	1,150 / 2,240	1,230 / 2,700
Static pressure range (Standard)	Indoor/Outdoor (Heating)	High	650 / 1,520	800 / 1,580	840 / 1,830	1,150 / 1,960	1,230 / 2,700
		Pa	30 to 150 (40)	30 to 150 (40)	30 to 150 (40)	30 to 150 (40)	30 to 150 (50)
Net Dimensions H x W x D	Indoor	mm	240 x 700 x 700	240 x 700 x 700	240 x 700 x 700	240 x 1,000 x 700	240 x 1,000 x 700
	Outdoor	mm	542 x 799 x 290	542 x 799 x 290	632 x 799 x 290	632 x 799 x 290	716 x 820 x 315
Weight	Indoor	kg	24	24	24	31	31
	Outdoor	kg	33	33	36	38	42
Connection Pipe Diameter (Liquid/Gas)		mm	6.35 / 9.52	6.35 / 9.52	6.35 / 12.7	6.35 / 12.70	6.35 / 12.70
Drain Hose Diameter (I.D./O.D.)		mm	25 / 32	25 / 32	25 / 32	25 / 32	25 / 32
Max. Pipe Length (Pre-Charge)		m	25 (15)	25 (15)	30 (20)	30 (20)	30 (20)
Max. Height Difference		m	20	20	20	25	25
Operating Range	Cooling	°CDB	-15 to 46	-15 to 46	-15 to 46	-15 to 46	-15 to 46
	Heating	°CDB	-15 to 24	-15 to 24	-15 to 24	-15 to 24	-15 to 24
Refrigerant	Type (Global Warming Potential)		R32 (675)	R32 (675)	R32 (675)	R32 (675)	R32 (675)
	Charge	kg (CO2eq-T)	0.85 (0.574)	0.85 (0.574)	1.02 (0.689)	1.25 (0.844)	1.25 (0.844)

Optional parts

* For optional parts compatibility of Intesis devices, please refer to the optional parts compatibility list page C-050 to C-053 and C-066.

Wired Remote Controller (Design type):	UTY-RVRG	Silver ion filter:	UTD-HFNC (12/14/18)	External input and output PCB:	UTY-XCSX
Compact wired remote controller:	UTY-RCRGZ1		UTD-HFNB (22/24)	External input and output PCB bracket:	UTZ-GXDA
Wired remote controller (touch panel):	UTY-RNRGZ5	Long-life filter:	UTD-LFDC (12/14/18)	Network Converter for single split (DC power supply type):	UTY-VTGX
Wired remote controller:	UTY-RLRG		UTD-LFDB (22/24)	Network Converter for single split (AC power supply type):	UTY-VTGXV
Simple remote controller (without operation mode):	UTY-RHRG	MODBUS converter:	UTY-VMSX	External connect kit:	UTY-XWZXXG
Simple remote controller:	UTY-RSRG	KNX converter:	UTY-VKSX1	IR receiver unit:	UTY-LBTGM
Remote sensor unit:	UTY-XSZX	WLAN adapter:	UTY-TFSXZ1	External switch controller:	UTY-TERX
	UTY-XSZXZ1		UTY-TFSXJ3		

Dimensions

(Unit: mm)

	ARXH 12 / 14 / 18 KMTAP	ARXH 22 / 24 KMTAP
a	650	895
b	740	1,040
c	P100 x 5 = 500	P100 x 8 = 800
d	P100 x 5 = 500	P100 x 7 = 700
e	700	1,000
f	490	790

*The design of the service access depends on the installation method. Refer to the installation manual for more information.

Medium Static Pressure Duct

High-Efficiency & Comfort



Slim & Compact design

The new product has reduced the height to 240 mm, making it more compact. The slim design fits nicely into narrow spaces under the ceiling.



(Unit: mm)

High energy saving

The new model has achieved high energy efficiency rank with a compact design.

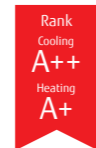

SEER **6.23**^{*1}

SCOP **4.10**^{*2}

*1: 30 model

*2: 36 model

Easy maintenance

The indoor units have large panels on both sides providing easy maintenance in narrow spaces.



Easy inspection of drain hose
The whole drain hose can be removed for easy replacement and cleaning.

Filter change
Filter can be installed and removed easily.
*Long life filter is available as optional parts.

Drain hose as standard

A drain hose is a standard accessory, making it easy to design drainage even in narrow spaces under the ceiling.

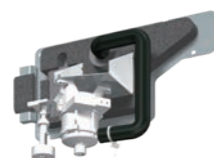

Wide range of static pressures

Static pressures can be changed in the range of 30 to 150 Pa.

Static pressure range **30 to 150 Pa**

Model: ARXH30KMTAP / ARXH36KMTAP / ARXH45KMTAP / ARXH54KMTAP
ARXH36KMTAP [3-phase] / ARXH45KMTAP [3-phase] / ARXH54KMTAP [3-phase]

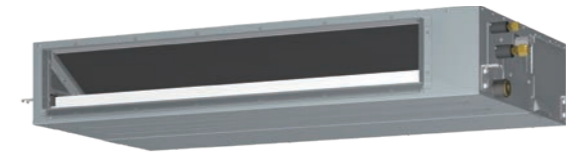

ARXH30/36/45/54KMTAP



For ARXH30/36KMTAP For ARXH45/54KMTAP

Specifications

Model name	Indoor unit			Outdoor unit		
	ARXH30KMTAP	ARXH36KMTAP	ARXH45KMTAP	ARXH36KMTAP	ARXH45KMTAP	ARXH54KMTAP
Power Source	Single phase, ~230 V, 50 Hz			3-phase, ~400 V, 50 Hz		
Capacity	Cooling	Rated	8.5	9.5	12.1	9.5
		Min.-Max.	2.8-10.0	2.8-11.2	4.0-13.5	2.8-11.2
	Heating	Rated	10.0	10.8	13.5	10.8
Input Power	Cooling/Heating	Rated	2.7-11.2	2.7-12.7	4.2-16.2	2.7-12.7
		Min.-Max.	2.57 / 2.50	2.97 / 2.70	3.87 / 3.73	2.97 / 2.70
EER	Cooling	W/W	3.31	3.20	3.13	3.20
COP	Heating	W/W	4.00	4.00	3.62	4.00
Pdesign	Cooling/Heating (-10°C)	kW	8.5 / 8.0	9.5 / 8.7	-	9.5 / 8.7
SEER	Cooling	W/W	6.23	6.10	-	6.10
SCOP	Heating (Average)	W/W	4.00	4.10	-	4.10
Energy Efficiency Class	Cooling		A++	A++	-	A++
	Heating (Average)		A+	A+	-	A+
Max. Operating Current	Cooling/Heating	A	22.6 / 22.6	22.6 / 22.6	28.5 / 28.5	10.5 / 10.5
Annual Energy Consumption	Cooling	kWh/a	485	553	-	553
	Heating	kWh/a	2,795	2,970	-	2,970
Moisture Removal		l/h	1.8	2.0	4.0	2.0
Sound Pressure Level	Indoor (Cooling)	H/M/L/Q	38 / 34 / 31 / 28	38 / 34 / 31 / 28	40 / 36 / 32 / 29	38 / 34 / 31 / 28
	Indoor (Heating)	H/M/L/Q	38 / 34 / 31 / 28	38 / 34 / 31 / 28	40 / 36 / 32 / 29	38 / 34 / 31 / 28
	Outdoor (Cooling/Heating)	High	53 / 55	55 / 55	57 / 57	55 / 55
Sound Power Level	Indoor (Cooling/Heating)	High	64 / 64	65 / 65	67 / 67	65 / 65
	Outdoor (Cooling/Heating)	High	68 / 69	70 / 70	71 / 71	70 / 70
	Indoor/Outdoor (Cooling)	High	1,950 / 3,750	2,070 / 3,750	2,160 / 4,450	2,070 / 3,750
Airflow Rate	Indoor/Outdoor (Cooling)	m³/h	1,950 / 3,750	2,070 / 3,750	2,160 / 4,450	2,070 / 3,750
	Indoor/Outdoor (Heating)	m³/h	1,950 / 3,750	2,070 / 3,750	2,160 / 4,450	2,070 / 3,750
Static pressure range (Standard)		Pa	30 to 150 (50)	30 to 150 (50)	30 to 150 (60)	30 to 150 (50)
Net Dimensions H x W x D	Indoor	mm	240 × 1,400 × 700	240 × 1,400 × 700	240 × 1,400 × 700	240 × 1,400 × 700
	Outdoor	mm	788 × 940 × 320	788 × 940 × 320	998 × 940 × 320	788 × 940 × 320
Weight	Indoor	kg	42	42	42	42
	Outdoor	kg	52	52	67	53
Connection Pipe Diameter (Liquid/Gas)		mm	9.52 / 15.88	9.52 / 15.88	9.52 / 15.88	9.52 / 15.88
Drain Hose Diameter (I.D./O.D.)		mm	25 / 32	25 / 32	25 / 32	25 / 32
Max. Pipe Length (Pre-Charge)		m	50 (30)	50 (30)	50 (30)	50 (30)
Max. Height Difference			30	30	30	30
Operating Range	Cooling	°CDB	-15 to 46	-15 to 46	-15 to 46	-15 to 46
	Heating	°CDB	-15 to 24	-15 to 24	-15 to 24	-15 to 24
Refrigerant	Type (Global Warming Potential)		R32 (675)	R32 (675)	R32 (675)	R32 (675)
	Charge	kg (CO2eq-T)	1.90 (1.283)	1.90 (1.283)	2.70 (1.823)	1.90 (1.283)

Optional parts

* For optional parts compatibility of Intesis devices, please refer to the optional parts compatibility list page C-050 to C-053 and C-066.

Wired Remote Controller (Design type):	UTY-RVRG	IR receiver unit:	UTY-LBTGM	External input and output PCB:	UTY-XCSX
Compact wired remote controller:	UTY-RCRGZ1	Silver ion filter:	UTD-HFNA	External input and output PCB bracket:	UTZ-GXDA
Wired remote controller (touch panel):	UTY-RNRGZ5	Long-life filter:	UTD-LFDA	Network Converter for single split (DC power supply type):	UTY-VTGX
Wired remote controller:	UTY-RLRG	MODBUS converter:	UTY-VMSX	Network Converter for single split (AC power supply type):	UTY-VTGXV
Simple remote controller (without operation mode):	UTY-RHRG	KNX converter:	UTY-VKSX	External connect kit:	UTY-XWZXZG
Simple remote controller:	UTY-RSRG	WLAN adapter:	UTY-TFSXZ1		
Remote sensor unit:	UTY-XSZX		UTY-TFSXJ3	(Outdoor unit)	
	UTY-XSZXZ1	External switch controller:	UTY-TERX	External connect kit:	UTY-XWZXZ3

Dimensions

(Unit: mm)

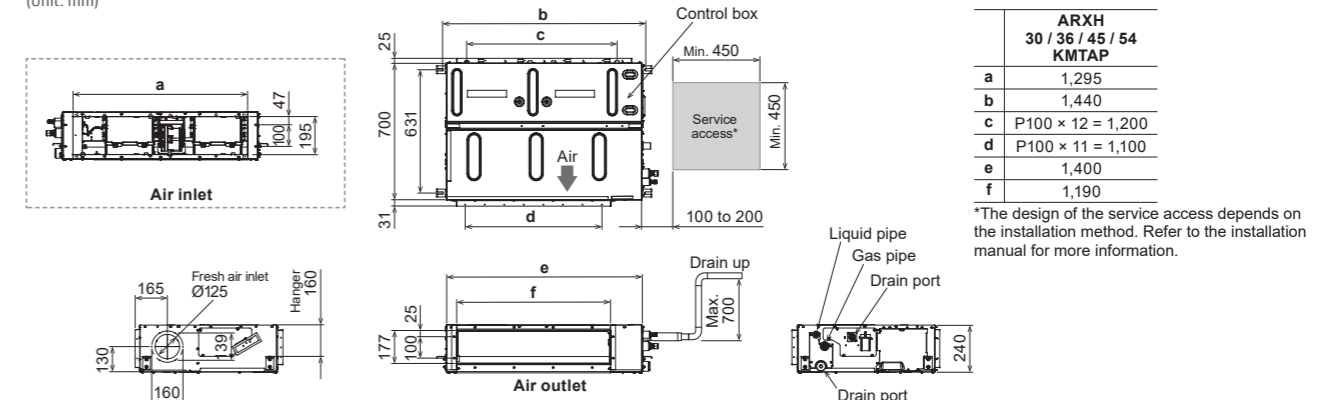

ARXH 30 / 36 / 45 / 54 KMTAP	
a	1,295
b	1,440
c	P100 × 12 = 1,200
d	P100 × 11 = 1,100
e	1,400
f	1,190

*The design of the service access depends on the installation method. Refer to the installation manual for more information.

Medium Static Pressure Duct

Compact Size

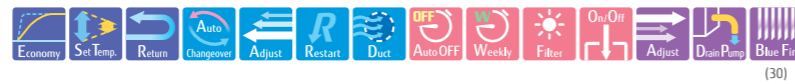

High-efficiency & Quiet operation

The combination of the V-shaped heat exchanger, air stabilizer, and the high-efficiency DC fan motor enable high-efficiency and quiet operation.

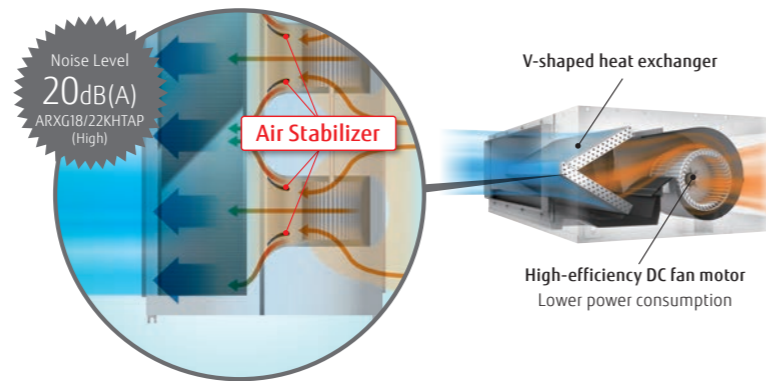

Small, lightweight outdoor unit

The outdoor unit in this series is smaller and lighter than previous-generation outdoor units. It can be installed in a narrow space.

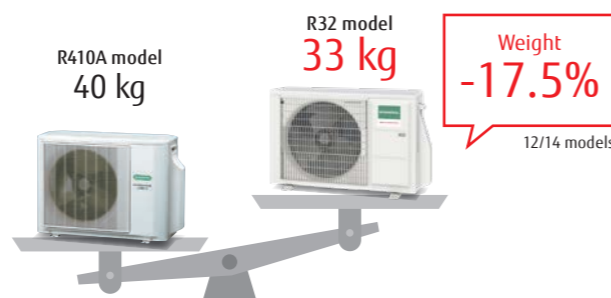

Automatic airflow adjustment function

This unique and innovative function detects required air flow in each application case and automatically adjust the volume.

Automatically adjust!

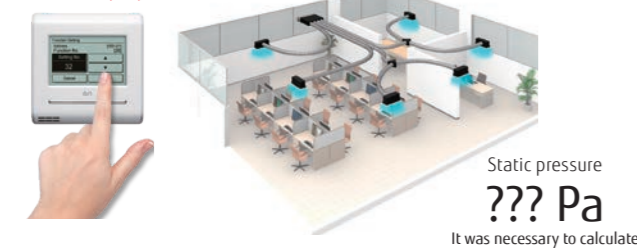

Link up with a variety of central control system (Option)

Centralized control including facilities and equipment in addition to air conditioning is possible by linking up with MODBUS, KNX interfaces.



Model: ARXG12KHTAP / ARXG14KHTAP / ARXG18KHTAP / ARXG22KHTAP / ARXG24KHTAP / ARXG30KHTAP



Specifications

Model name	Indoor unit		ARXG12KHTAP	ARXG14KHTAP	ARXG18KHTAP	ARXG22KHTAP	ARXG24KHTAP	ARXG30KHTAP
	Outdoor unit		AOHG12KBTB	AOHG14KBTB	AOHG18KBTB	AOHG22KBTB	AOHG24KBTB	AOHG30KBTB
Power Source			Single phase, ~230 V, 50 Hz					
Capacity	Cooling	Rated	3.5	4.3	5.2	6.0	6.8	8.5
		Min.-Max.	0.9-4.4	0.9-5.4	0.9-5.9	0.9-6.7	0.9-8.0	2.8-10.0
	Heating	Rated	4.1	5.0	6.0	7.0	7.5	10.0
Min.-Max.		0.9-5.7	0.9-6.5	0.9-7.5	0.9-8.0	0.9-9.1	2.7-11.2	
Input Power	Cooling/Heating	kW	0.87/1.00	1.17/1.25	1.36/1.56	1.71/1.81	1.89/1.85	2.65/2.63
EER	Cooling	W/W	4.02	3.68	3.82	3.51	3.60	3.21
COP	Heating	W/W	4.10	4.00	3.85	3.87	4.06	3.80
Pdesign	Cooling/Heating (-10°C)	kW	3.5/3.4	4.3/3.8	5.2/4.4	6.0/4.8	6.8/6.0	8.5/8.0
SEER	Cooling	W/W	6.30	6.20	6.50	6.50	6.50	6.23
SCOP	Heating (Average)	W/W	4.10	4.00	4.10	4.20	4.10	4.00
Energy Efficiency Class	Cooling		A++	A++	A++	A++	A++	A++
	Heating (Average)		A+	A+	A+	A+	A+	A+
Max. Operating Current	Cooling/Heating	A	9.7/9.7	10.2/10.2	12.1/12.1	12.6/12.6	13.6/13.6	22.6/22.6
Annual Energy Consumption	Cooling	kWh/a	194	243	280	323	366	477
	Heating		1,159	1,328	1,501	1,597	2,048	2,796
Moisture Removal		l/h	0.7	0.9	1.2	1.5	1.8	2.3
Sound Pressure Level	Indoor (Cooling)	H/M/L/Q	32/27/26/24	33/28/27/25	28/25/22/20	28/25/22/20	32/28/24/21	36/33/30/29
	Outdoor (Cooling/Heating)	High	47/47	49/49	50/50	51/51	53/54	53/55
Sound Power Level	Indoor (Cooling/Heating)	High	57/58	59/60	54/54	57/57	57/57	63/65
	Outdoor (Cooling/Heating)	High	61/61	62/62	62/62	63/63	65/66	68/69
Airflow Rate	Indoor/Outdoor (Cooling)	High	850/1,580	950/1,670	1,050/2,160	1,050/2,240	1,360/2,700	1,700/3,750
	Indoor/Outdoor (Heating)	High	850/1,520	950/1,580	1,050/1,830	1,050/1,960	1,360/2,700	1,700/3,750
Static pressure range (Standard)		Pa	30 to 200 (35)	30 to 200 (35)	30 to 200 (35)	30 to 200 (35)	30 to 200 (35)	30 to 200 (47)
Net Dimensions H x W x D	Indoor	mm	300 x 700 x 700	300 x 700 x 700	300 x 1,000 x 700	300 x 1,000 x 700	300 x 1,000 x 700	300 x 1,000 x 700
	Outdoor	mm	542 x 799 x 290	542 x 799 x 290	632 x 799 x 290	632 x 799 x 290	716 x 820 x 315	788 x 940 x 320
Weight	Indoor	kg	27	27	35	35	36	36
	Outdoor	kg	33	33	36	38	42	52
Connection Pipe Diameter (Liquid/Gas)		mm	6.35/9.52	6.35/9.52	6.35/12.70	6.35/12.70	6.35/12.70	9.52/15.88
Drain Hose Diameter (I.D./O.D.)		mm	25/32	25/32	25/32	25/32	25/32	25/32
Max. Pipe Length (Pre-Charge)		m	25 (15)	25 (15)	30 (20)	30 (20)	30 (20)	50 (30)
Max. Height Difference	Cooling		20	20	20	25	25	30
	Heating		-15 to 24	-15 to 24	-15 to 24	-15 to 24	-15 to 24	-15 to 24
Operating Range	Cooling	°CDB	-15 to 46	-15 to 46	-15 to 46	-15 to 46	-15 to 46	-15 to 46
	Heating		-15 to 24	-15 to 24	-15 to 24	-15 to 24	-15 to 24	-15 to 24
Refrigerant	Type (Global Warming Potential)		R32 (675)	R32 (675)	R32 (675)	R32 (675)	R32 (675)	R32 (675)
	Charge	kg (CO ₂ eq-t)	0.85 (0.574)	0.85 (0.574)	1.02 (0.689)	1.25 (0.844)	1.25 (0.844)	1.90 (1.283)

Optional parts

* For optional parts compatibility of Intesis devices, please refer to the optional parts compatibility list page C-050 to C-053 and C-066.

Wired Remote Controller (Design type):	UTY-RVRG	Long-life filter:	UTD-LFNB (18-30)	External input and output PCB:	UTY-XCSX
Compact wired remote controller:	UTY-RCRGZ1		UTD-LFNC (12-14)	External connect kit:	UTY-XWZXZG
Wired remote controller (touch panel):	UTY-RNRGZ5	Silver Ion Filter:	UTD-HFNB (18-30)	External input and output PCB bracket:	UTZ-GXNA
Wired remote controller:	UTY-RLRG		UTD-HFNC (12/14)	Network Converter for single split (DC power supply type):	UTY-VTGV
	UTY-RNNGM	WLAN adapter:	UTY-TFSXZ1	Network Converter for single split (AC power supply type):	UTY-VTGXV
	UTY-RVNGM		FG-RC-WIF122	External switch controller:	UTY-TERX
Simple remote controller (without operation mode):	UTY-RHRG		UTY-TFSXJ3		
Simple remote controller:	UTY-RSRG		FG-AC-WIF121		
Remote sensor unit:	UTY-XS2XZ1	IR receiver unit:	UTY-LBTGM	(Outdoor unit 30)	
				External connect kit:	UTY-XWZXZ3

Dimensions

(Unit: mm)

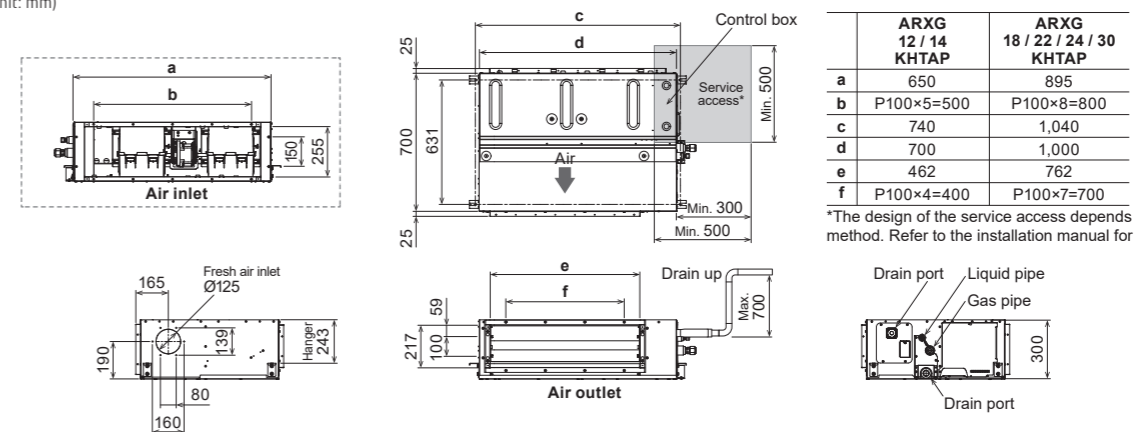

Medium Static Pressure Duct

Compact Size

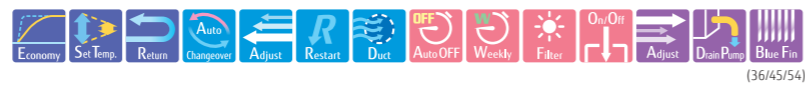

High-efficiency & Quiet operation

The combination of the V-shaped heat exchanger, air stabilizer, and the high-efficiency DC fan motor enable high-efficiency and quiet operation.

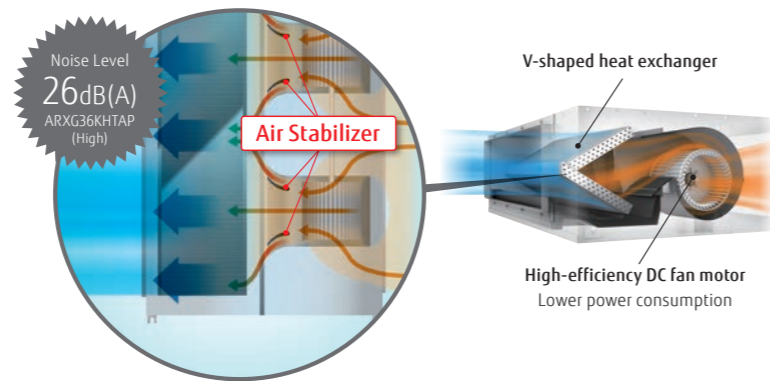

Small, lightweight outdoor unit

The outdoor unit in this series is smaller and lighter than previous-generation outdoor units. It can be installed in a narrow space.

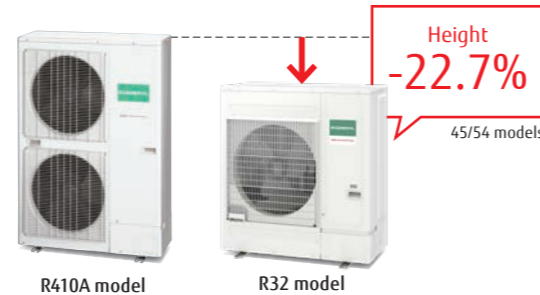

Automatic airflow adjustment function

This unique and innovative function detects required air flow in each application case and automatically adjust the volume.

Automatically adjust!

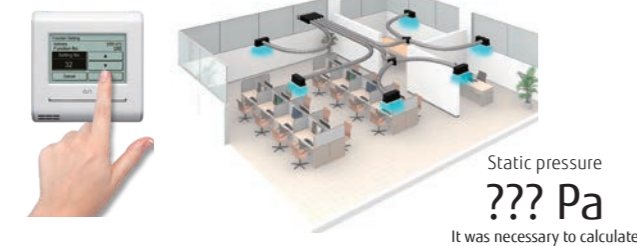

Link up with a variety of central control system (Option)

Centralized control including facilities and equipment in addition to air conditioning is possible by linking up with MODBUS, KNX interfaces.



Model: ARXG36KHTAP / ARXG45KHTAP / ARXG54KHTAP
ARXG36KHTAP [3-phase] / ARXG45KHTAP [3-phase] / ARXG54KHTAP [3-phase]



Specifications

Model name	Indoor unit			Outdoor unit				
	ARXG36KHTAP	ARXG45KHTAP	ARXG54KHTAP	AOHG36KBTB	AOHG45KBTB	AOHG54KBTB		
Power Source	Single phase, ~230 V, 50 Hz			3-phase, ~400 V, 50 Hz				
Capacity	Cooling	Rated	9.5	12.1	13.4	9.5	12.1	13.4
		Min.-Max.	2.8-11.2	4.0-14.0	4.5-14.5	2.8-11.2	4.0-14.0	4.5-14.5
	Heating	Rated	10.8	13.5	15.5	10.8	13.5	15.5
Input Power	Cooling/Heating	Rated	2.7-12.7	4.2-16.2	4.7-16.5	2.7-12.7	4.2-16.2	4.7-16.5
		Min.-Max.	2.86/2.48	3.53/3.37	4.42/3.89	2.86/2.48	3.53/3.37	4.42/3.89
EER	Cooling		3.32	3.43	3.03	3.32	3.43	3.03
COP	Heating		4.35	4.01	3.98	4.35	4.01	3.98
Pdesign	Cooling/Heating (-10°C)		9.5/8.7	-	-	9.5/8.7	-	-
SEER	Cooling		6.10	-	-	6.10	-	-
SCOP	Heating (Average)		4.20	-	-	4.20	-	-
Energy Efficiency Class	Cooling		A++	-	-	A++	-	-
	Heating (Average)		A+	-	-	A+	-	-
Max. Operating Current	Cooling/Heating		22.6/22.6	28.5/28.5	28.5/28.5	10.5/10.5	14.0/14.0	14.0/14.0
Annual Energy Consumption	Cooling		544	-	-	544	-	-
	Heating		2,898	-	-	2,898	-	-
Moisture Removal			2.0	2.6	3.7	2.0	2.6	3.7
Sound Pressure Level	Indoor (Cooling)	H/M/L/Q	36/31/28/26	39/35/31/29	39/35/31/29	36/31/28/26	39/35/31/29	39/35/31/29
	Outdoor (Cooling/Heating)	High	33/31/28/26	39/35/31/29	39/35/31/29	33/31/28/26	39/35/31/29	39/35/31/29
Sound Power Level	Indoor (Cooling/Heating)	High	55/55	57/57	57/59	55/55	57/57	57/59
	Outdoor (Cooling/Heating)	High	64/63	67/69	67/69	64/63	67/69	67/69
Airflow Rate	Indoor/Outdoor (Cooling)	High	2,050/3,750	2,550/4,450	2,550/4,450	2,050/3,750	2,550/4,450	2,550/4,450
	Indoor/Outdoor (Heating)	High	1,850/3,750	2,550/4,450	2,550/4,450	1,850/3,750	2,550/4,450	2,550/4,450
Static pressure range (Standard)			30 to 200 (47)	30 to 200 (60)	30 to 200 (60)	30 to 200 (47)	30 to 200 (60)	30 to 200 (60)
Net Dimensions H x W x D	Indoor	mm	300 x 1,400 x 700	300 x 1,400 x 700	300 x 1,400 x 700	300 x 1,400 x 700	300 x 1,400 x 700	300 x 1,400 x 700
	Outdoor	mm	788 x 940 x 320	998 x 940 x 320	998 x 940 x 320	788 x 940 x 320	998 x 940 x 320	998 x 940 x 320
Weight	Indoor	kg	46	46	46	46	46	46
	Outdoor	kg	52	67	67	53	67	67
Connection Pipe Diameter (Liquid/Gas)		mm	9.52/15.88	9.52/15.88	9.52/15.88	9.52/15.88	9.52/15.88	9.52/15.88
Drain Hose Diameter (I.D./O.D.)		mm	25/32	25/32	25/32	25/32	25/32	25/32
Max. Pipe Length (Pre-Charge)		m	50 (30)	50 (30)	50 (30)	50 (30)	50 (30)	50 (30)
Max. Height Difference			30	30	30	30	30	30
Operating Range	Cooling	°CDB	-15 to 46	-15 to 46	-15 to 46	-15 to 46	-15 to 46	-15 to 46
	Heating		-15 to 24	-15 to 24	-15 to 24	-15 to 24	-15 to 24	-15 to 24
Refrigerant	Type (Global Warming Potential)		R32 (675)	R32 (675)	R32 (675)	R32 (675)	R32 (675)	R32 (675)
	Charge	kg (CO2eq-T)	1.90 (1.283)	2.70 (1.823)	2.70 (1.823)	1.90 (1.283)	2.70 (1.823)	2.70 (1.823)

Optional parts

* For optional parts compatibility of Intesis devices, please refer to the optional parts compatibility list page C-050 to C-053 and C-066.

Wired Remote Controller (Design type):	UTY-RVRG	Long-life filter:	UTD-LFNA	External input and output PCB:	UTY-XCSX
Compact wired remote controller:	UTY-RCRGZ1	Silver Ion Filter:	UTD-HFNA	External input and output PCB bracket:	UTZ-GXNA
Wired remote controller (touch panel):	UTY-RNRGZ5		UTY-TFSXZ1	Network Converter for single split (DC power supply type):	UTY-VTGX
Wired remote controller:	UTY-RLRG		FG-RC-WIF1Z2	Network Converter for single split (AC power supply type):	UTY-VTGXV
	UTY-RNNGM	WLAN adapter:	UTY-TFSXJ3		
	UTY-RVNGM		FG-AC-WIF1Z1	(Outdoor unit 36/45/54)	
Simple remote controller (without operation mode):	UTY-RHRG	External switch controller:	UTY-TERX	External connect kit:	UTY-XWZXZ3
Simple remote controller:	UTY-RSRG	IR receiver unit:	UTY-LBTGM		
Remote sensor unit:	UTY-XSZXZ1	External connect kit:	UTY-XWZXZG		

Dimensions

(Unit: mm)

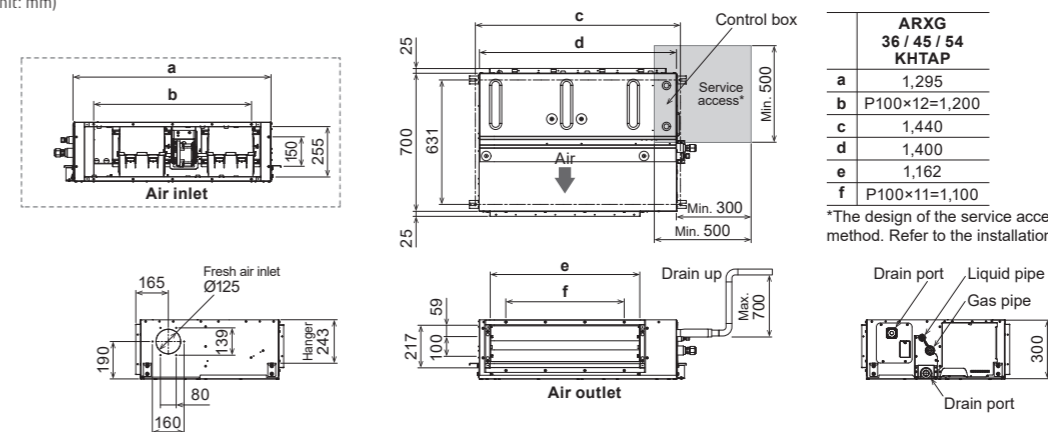

Medium Static Pressure Duct Standard



Easy maintenance

Structural improvement is attained by making the bottom panel in two pieces—front and rear. The internal fan casing is also manufactured in two pieces—upper and lower. As a result, the motor and fan can be easily accessed and maintained by removing the rear panel and the lower casing while leaving the main chassis in place.

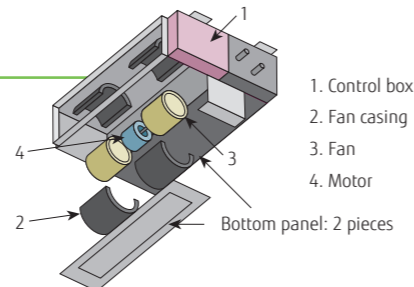

See below for case of rear-suction type

Slim & Compact design

Indoor Unit

The slim and compact design of the indoor unit, with the control box mounted on the side, allows installation in narrow spaces.

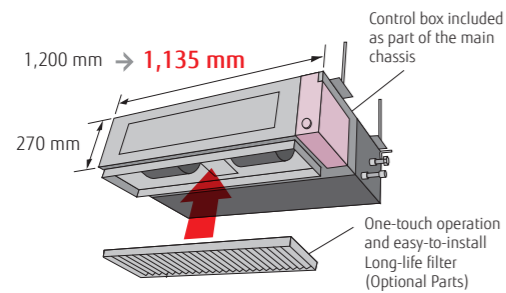

Outdoor Unit

The outdoor units for the 45,000 BTU and 54,000 BTU models have been completely redesigned. Easier installation is achieved for this compact and lightweight outdoor unit.

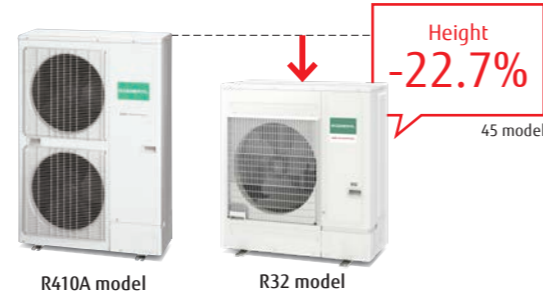

Two-direction drain piping

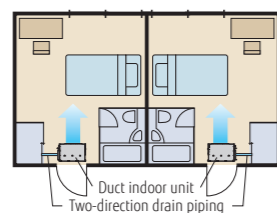

Link up with a variety of central control system (Option)

Centralized control including facilities and equipment in addition to air conditioning is possible by linking up with MODBUS, KNX interfaces.



Model: ARXG22KMLB / ARXG24KMLA / ARXG30KMLA / ARXG36KMLA / ARXG45KMLA
ARXG36KMLA [3-phase] / ARXG45KMLA [3-phase]

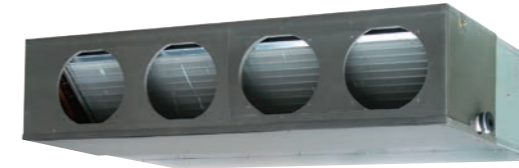

Specifications

Model name	Indoor unit		ARXG22KMLB	ARXG24KMLA	ARXG30KMLA	ARXG36KMLA	ARXG45KMLA	ARXG36KMLA	ARXG45KMLA
	Outdoor unit		AOHG22KBTB	AOHG24KBTB	AOHG30KBTB	AOHG36KBTB	AOHG45KBTB	AOHG36KRTA	AOHG45KRTA
Power Source	Single phase, ~230 V, 50 Hz							3-phase, ~400 V, 50 Hz	
Capacity	Cooling	Rated	6.0	6.8	8.5	9.5	12.1	9.5	12.1
		Min.-Max.	0.9-6.7	0.9-8.0	2.8-10.0	2.8-11.2	4.0-13.0	2.8-11.2	4.0-13.0
	Heating	Rated	7.0	7.5	10.0	10.8	13.5	10.8	13.5
Min.-Max.		0.9-8.0	0.9-9.1	2.7-11.2	2.7-12.7	4.2-15.2	2.7-12.7	4.2-15.2	
Input Power	Cooling/Heating	kW	1.78/1.87	2.14/1.97	2.65/2.63	2.97/2.88	4.22/3.84	2.97/2.88	4.22/3.84
EER	Cooling	W/W	3.37	3.18	3.21	3.20	2.87	3.20	2.87
COP	Heating	W/W	3.74	3.80	3.80	3.75	3.52	3.75	3.52
Pdesign	Cooling/Heating (-10°C)	kW	6.0/4.8	6.8/6.0	8.5/8.0	9.5/8.7	-	9.5/8.7	-
SEER	Cooling	W/W	6.10	6.20	6.23	6.10	-	6.10	-
SCOP	Heating	W/W	4.10	4.10	4.00	4.00	-	4.00	-
Energy Efficiency Class	Cooling		A++	A++	A++	A++	-	A++	-
	Heating		A+	A+	A+	A+	-	A+	-
Max. Operating Current	Cooling/Heating	A	12.6/12.6	13.6/13.6	22.6/22.6	22.6/22.6	28.5/28.5	10.5/10.5	14.0/14.0
Annual Energy Consumption	Cooling	kWh/a	344	384	477	545	-	545	-
	Heating	kWh/a	1,637	2,045	2,797	3,044	-	3,044	-
Moisture Removal		l/h	2.1	2.5	2.5	3.0	4.0	3.0	4.0
Sound Pressure Level	Indoor (Cooling)	H/M/L/Q	31/29/27/25	31/29/27/25	39/35/30/26	39/35/30/26	42/38/32/28	39/35/30/26	42/38/32/28
	Indoor (Heating)	H/M/L/Q	31/29/27/25	31/29/27/25	42/35/30/26	42/35/30/26	42/38/32/28	42/35/30/26	42/38/32/28
Sound Power Level	Outdoor (Cooling/Heating)	High	51/51	53/54	53/55	55/55	57/57	55/55	57/57
	Outdoor (Cooling/Heating)	High	60/62	60/62	65/69	65/70	68/70	65/70	68/70
Airflow Rate	Indoor/Outdoor (Cooling)	High	1,100/2,240	1,100/2,700	1,900/3,750	1,900/3,750	2,100/4,450	1,900/3,750	2,100/4,450
	Indoor/Outdoor (Heating)	High	1,100/1,960	1,100/2,700	2,100/3,750	2,100/3,750	2,100/4,450	2,100/3,750	2,100/4,450
Static pressure range (Standard)		Pa	30 to 150 (35)	30 to 150 (35)	30 to 150 (47)	30 to 150 (47)	30 to 150 (60)	30-150 (47)	30-150 (60)
Net Dimensions H x W x D	Indoor	mm	270 x 1,135 x 700	270 x 1,135 x 700	270 x 1,135 x 700	270 x 1,135 x 700	270 x 1,135 x 700	270 x 1,135 x 700	270 x 1,135 x 700
	Outdoor	mm	632 x 799 x 290	716 x 820 x 315	788 x 940 x 320	788 x 940 x 320	998 x 940 x 320	788 x 940 x 320	998 x 940 x 320
Weight	Indoor	kg	35	35	38	38	39	38	39
	Outdoor	kg	38	42	52	52	67	53	67
Connection Pipe Diameter (Liquid/Gas)		mm	6.35/12.70	6.35/12.70	9.52/15.88	9.52/15.88	9.52/15.88	9.52/15.88	9.52/15.88
Drain Hose Diameter (I.D./O.D.)		mm	35.7/38.1	35.7/38.1	35.7/38.1	35.7/38.1	35.7/38.1	35.7/38.1	35.7/38.1
Max. Pipe Length (Pre-Charge)		m	30 (20)	30 (20)	50 (30)	50 (30)	50 (30)	50 (30)	50 (30)
Max. Height Difference		m	25	25	30	30	30	30	30
Operating Range	Cooling	°CDB	-15 to 46	-15 to 46	-15 to 46	-15 to 46	-15 to 46	-15 to 46	-15 to 46
	Heating	°CDB	-15 to 24	-15 to 24	-15 to 24	-15 to 24	-15 to 24	-15 to 24	-15 to 24
Refrigerant	Type (Global Warming Potential)		R32 (675)	R32 (675)	R32 (675)	R32 (675)	R32 (675)	R32 (675)	R32 (675)
	Charge	kg (CO2eq-T)	1.25 (0.844)	1.25 (0.844)	1.90 (1.283)	1.90 (1.283)	2.70 (1.823)	1.90 (1.283)	2.70 (1.823)

Optional parts

* For optional parts compatibility of Intesis devices, please refer to the optional parts compatibility list page C-050 to C-053 and C-066.

Wired Remote Controller (Design type):	UTY-RVRG	WLAN adapter:	UTY-TFSXZ1	Network Converter for single split (DC power supply type):	UTY-VTGX
Compact wired remote controller:	UTY-RCRGZ1		FG-RC-WIF12Z	Network Converter for single split (AC power supply type):	UTY-VTGXV
Wired remote controller (touch panel):	UTY-RNRGZ5		UTY-TFSXJ3	Long-life filter:	UTD-LF25NA
Wired remote controller:	UTY-RLRG		FG-AC-WIF1Z1	Silver Ion Filter:	UTD-HFND
	UTY-RNNGM	Flange (Round):	UTD-RF204	External connect kit:	UTY-XWZXZG
	UTY-RVNGM	Flange (Square):	UTD-SF045T		
Simple remote controller (without operation mode):	UTY-RHRG	IR receiver unit:	UTY-LBTGM	(Outdoor unit 30/36/45)	
Simple remote controller:	UTY-RSRG	Remote sensor unit:	UTY-XS2XZ1	External connect kit:	UTY-XWZXZ3
External switch controller:	UTY-TERX	Drain pump unit:	UTZ-PX1NBA		

Dimensions

(Unit: mm)

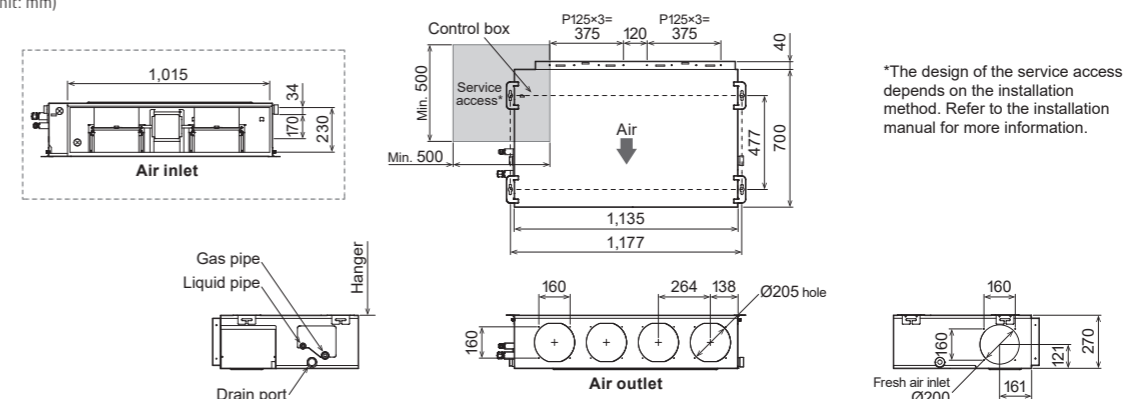

*The design of the service access depends on the installation method. Refer to the installation manual for more information.

High Static Pressure Duct



Model: ARXG45KHTB / ARXG54KHTB
ARXG45KHTB [3-phase] / ARXG54KHTB [3-phase]



Specifications

Model name	Indoor unit		ARXG45KHTB	ARXG54KHTB	ARXG45KHTB	ARXG54KHTB
	Outdoor unit		AOHG45KHTB	AOHG54KHTB	AOHG45KRTA	AOHG54KRTA
Power Source	Single phase, ~230 V, 50 Hz				3-phase, ~400 V, 50 Hz	
Capacity	Cooling	Rated	12.1	13.4	12.1	13.4
		Min.-Max.	4.0-14.0	5.0-14.5	4.0-14.0	5.0-14.5
	Heating	Rated	13.5	15.5	13.5	15.5
		Min.-Max.	5.0-16.2	5.5-18.0	5.0-16.2	5.5-18.0
Input Power	Cooling/Heating	kW	4.16/3.61	4.77/4.18	4.16/3.61	4.77/4.18
EER	Cooling	W/W	2.91	2.81	2.91	2.81
COP	Heating	W/W	3.74	3.71	3.74	3.71
Pdesign	Cooling/Heating (-10°C)	kW	-	-	-	-
SEER	Cooling	W/W	-	-	-	-
SCOP	Heating	W/W	-	-	-	-
Energy Efficiency Class	Cooling	-	-	-	-	-
	Heating	-	-	-	-	-
Max. Operating Current	Cooling/Heating	A	28.5/28.5	28.5/28.5	14.0/14.0	14.0/14.0
Annual Energy Consumption	Cooling	kWh/a	-	-	-	-
	Heating	kWh/a	-	-	-	-
Moisture Removal		l/h	1.5	2.0	1.5	2.0
Sound Pressure Level	Indoor (Cooling)	H/M/L	47/43/40	47/43/40	47/43/40	47/43/40
	Indoor (Heating)	H/M/L	47/43/40	47/43/40	47/43/40	47/43/40
Sound Power Level	Outdoor (Cooling/Heating)	High	57/57	57/59	57/57	57/59
	Indoor (Cooling/Heating)	High	75/74	75/74	75/74	75/74
Airflow Rate	Indoor/Outdoor (Cooling)	High	3,350/4,450	3,350/4,450	3,350/4,450	3,350/4,450
	Indoor/Outdoor (Heating)	High	3,350/4,450	3,350/4,450	3,350/4,450	3,350/4,450
Static pressure range (Standard)		Pa	100 to 250 (100)	100 to 250 (100)	100 to 250 (100)	100 to 250 (100)
Net Dimensions	Indoor	mm	400 × 1,050 × 500	400 × 1,050 × 500	400 × 1,050 × 500	400 × 1,050 × 500
H x W x D	Outdoor	mm	998 × 940 × 320	998 × 940 × 320	998 × 940 × 320	998 × 940 × 320
Weight	Indoor	kg	46	46	46	46
	Outdoor	kg	67	67	67	67
Connection Pipe Diameter (Liquid/Gas)		mm	9.52/15.88	9.52/15.88	9.52/15.88	9.52/15.88
Drain port Diameter (I.D./O.D.)		mm	23.4/25.4	23.4/25.4	23.4/25.4	23.4/25.4
Max. Pipe Length (Pre-Charge)		m	50 (30)	50 (30)	50 (30)	50 (30)
Max. Height Difference			30	30	30	30
Operating Range	Cooling	°CDB	-15 to 46	-15 to 46	-15 to 46	-15 to 46
	Heating	°CDB	-15 to 24	-15 to 24	-15 to 24	-15 to 24
Refrigerant	Type (Global Warming Potential)		R32 (675)	R32 (675)	R32 (675)	R32 (675)
	Charge	kg (CO2eq-T)	2.70 (1.823)	2.70 (1.823)	2.70 (1.823)	2.70 (1.823)

Easy installation (Compact & Lightweight)

The indoor and outdoor units are designed to be compact and light by reducing the basic chassis size and the overall material weight.

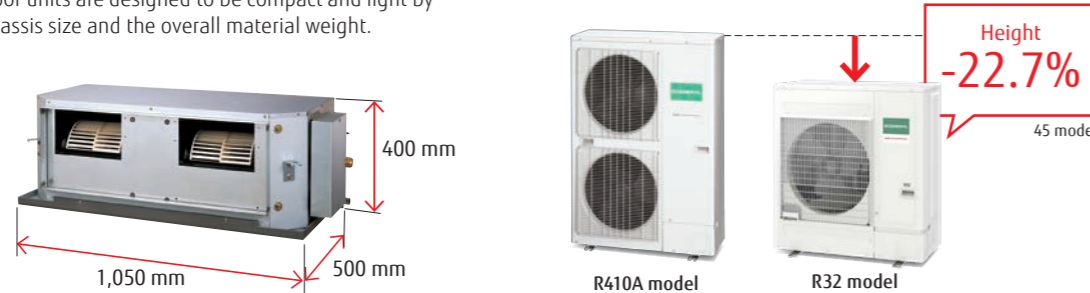

Design also suits high static pressure



Low noise

Slanted corners at the top help reduce turbulent airflow. Low noise is realized by adopting a plastic case and a plastic fan.

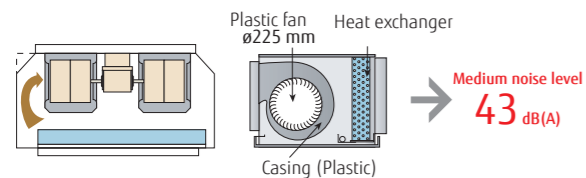

Link up with a variety of central control system (Option)

Centralized control including facilities and equipment in addition to air conditioning is possible by linking up with MODBUS, KNX interfaces.



Optional parts

* For optional parts compatibility of Intesis devices, please refer to the optional parts compatibility list page C-050 to C-053 and C-066.

Wired Remote Controller (Design type):	UTY-RVRG	Remote sensor unit:	UTY-XSZXZ1	Network Converter for single split (DC power supply type):	UTY-VTGX
Compact wired remote controller:	UTY-RCRGZ1	Long-life filter:	UTD-LF60KA	Network Converter for single split (AC power supply type):	UTY-VTGXV
Wired remote controller (touch panel):	UTY-RNRGZ5	External switch controller:	UTY-TERX	Silver Ion Filter:	UTD-HFKB
Wired remote controller:	UTY-RLRG	WLAN adapter:	UTY-TFSXZ1	External connect kit:	UTY-XWZXZG
Simple remote controller:	UTY-RSRG		UTY-TFSXJ3		
	UTY-RHRG		FG-AC-WIF1Z1	(Outdoor unit)	
IR Receiver unit:	UTY-LBTGM	External input and output PCB:	UTY-XCSX+UTZ-GXEA	External connect kit:	UTY-XWZXZ3

Dimensions

(Unit: mm)

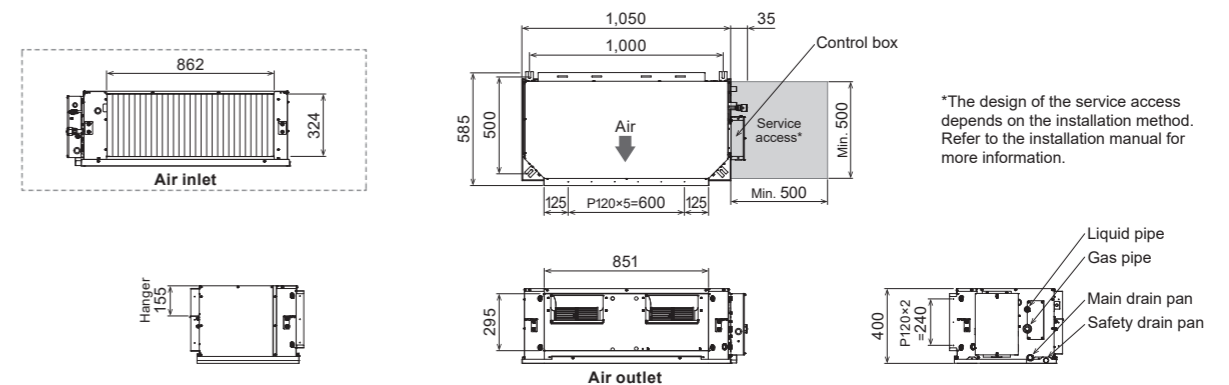

*The design of the service access depends on the installation method. Refer to the installation manual for more information.

High Static Pressure Duct



High energy efficiency

Much greater efficiency is achieved by the use of all-DC inverter technology.

Design also corresponding to high static pressure

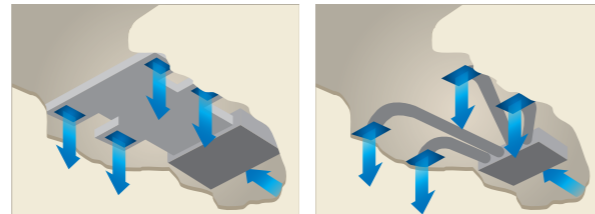
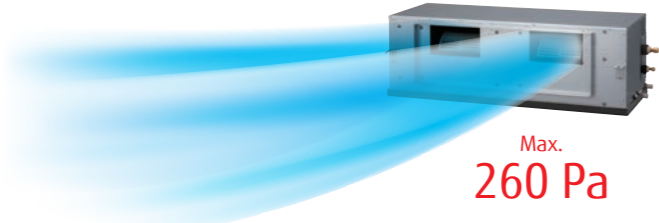

Easy installation (Compact & Lightweight)

The indoor unit is designed to be compact and light by reducing the basic chassis size and the overall material weight.

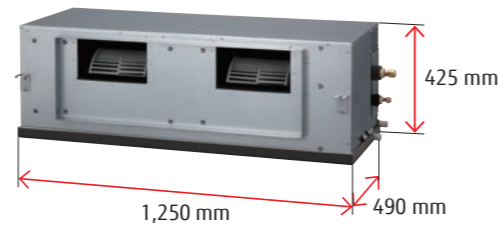

Low noise

Slanted corners at the top help reduce turbulent airflow. Low noise is realized by adopting a plastic case and a plastic fan.

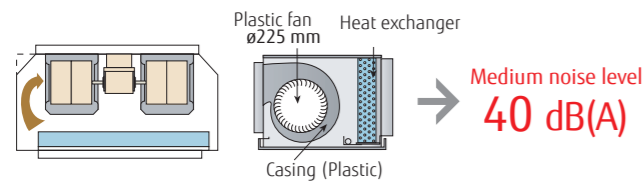

Link up with a variety of central control system (Option)

Centralized control including facilities and equipment in addition to air conditioning is possible by linking up with MODBUS, KNX interfaces.



Model: ARHG60LHTA [3-phase]



Specifications

Model name	Indoor unit		Outdoor unit		ARHG60LHTA	AOHG60LATT	
	Indoor unit		Outdoor unit				
Power Source					3-phase, ~400 V, 50 Hz		
Capacity	Cooling	Rated	kW	15.0			
		Min.-Max.		6.2-17.5			
	Heating	Rated		18.0			
		Min.-Max.		6.2-20.0			
Input Power	Cooling/Heating		kW	4.70/5.15			
EER	Cooling		W/W	3.19			
COP	Heating			3.50			
Max. Operating Current	Cooling/Heating		A	12.5 / 12.5			
Moisture Removal					l/h		
				2.0			
Sound Pressure	Indoor (Cooling)	H/M/L/Q	dB(A)	45/40/36/-			
	Indoor (Heating)	H/M/L/Q		45/40/36/-			
	Outdoor (Cooling/Heating)	High		56/58			
Airflow Rate	Indoor/Outdoor (Cooling)	High	m ³ /h	3,550/6,900			
	Indoor/Outdoor (Heating)	High		3,550/7,300			
Static pressure range (Standard)					Pa		
					60 to 260 (60)		
Net Dimensions	Indoor			mm			
				425 × 1,250 × 490			
H x W x D	Outdoor			mm			
				1,290 × 900 × 330			
Weight	Indoor			kg			
				54			
	Outdoor			kg			
				104			
Connection Pipe Diameter (Liquid/Gas)					mm		
					9.52/15.88		
Drain Hose Diameter (I.D./O.D.)					mm		
					23.4/25.4		
Max. Pipe Length (Pre-Charge)					m		
					75 (30)		
Max. Height Difference					m		
					30		
Operating Range	Cooling			°CDB			
	Heating			-15 to 46			
					-15 to 24		
Refrigerant	Type (Global Warming Potential)					R410A (2,088)	
	Charge	kg (CO2eq-T)		3.45 (7.204)			

Optional parts

* For optional parts compatibility of Intesis devices, please refer to the optional parts compatibility list page C-050 to C-053 and C-066.

Wired remote controller:	UTY-RNNGM	Network Converter for single split (DC power supply type):	UTY-VTGX
Wired remote controller:	UTY-RVNGM	Network Converter for single split (AC power supply type):	UTY-VTGXV
External switch controller:	UTY-TERX	External connect kit:	UTD-ECS5A
WLAN adapter:	UTY-TFNXZ1	(Outdoor unit)	
	FG-RC-WIF1Z2	External connect kit:	UTY-XWZXZ2
Remote sensor unit:	UTY-XSZXZ1		
IR receiver unit:	UTY-LRHGM		

Dimensions

(Unit: mm)

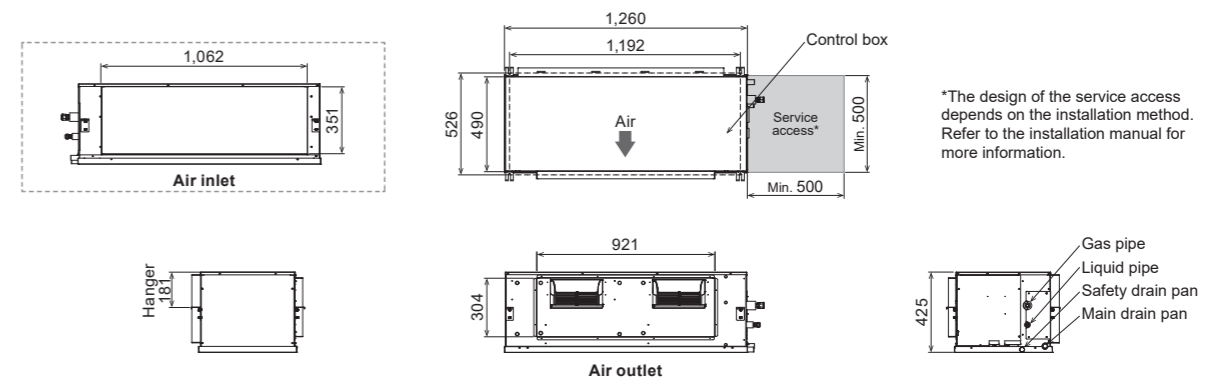

*The design of the service access depends on the installation method. Refer to the installation manual for more information.

Floor Compact Size



High energy saving

The Floor 09 class achieves a top-class SEER of 8.50 and an A+++ seasonal efficiency rank for cooling. The Floor 09 class achieves an improved SCOP of 4.30 and an A+ seasonal efficiency rank for heating.

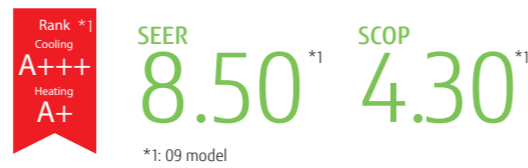

Flexible & easy installation

The compact and whole-surface suction design provides flexible installation options, including floor-standing, embedded, half concealed, and wall mount installation to match the room layout.

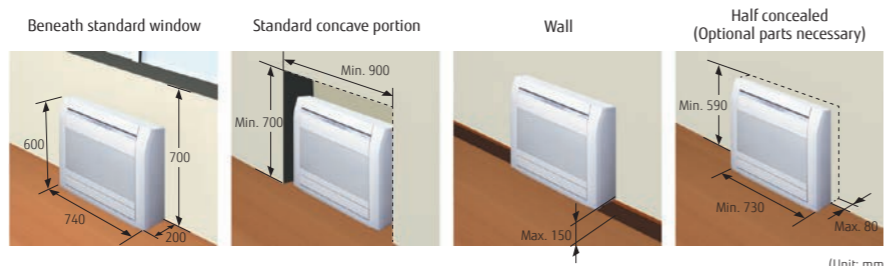

* Concaved position installation with concealment is prohibited.

Low ambient operation

Factory-guaranteed cooling operation down to -10°C ambient temperature.

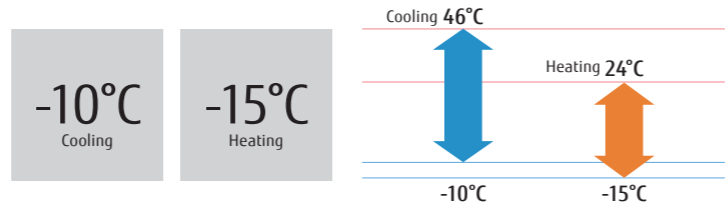

Smart device control (Option)

With the optional WLAN adapter installed in the air conditioner, you can control it from anywhere with your smart device.

* See page C-020 for details on smart device control.



10°C heat

The room temperature can be set to go no lower than 10°C, thus ensuring that the room does not get too cold when not occupied.

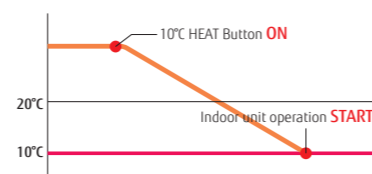

Model: AGHG09KVCA / AGHG12KVCA / AGHG14KVCA



Specifications

Model name	Indoor unit		Outdoor unit		AGHG09KVCA	AGHG12KVCA	AGHG14KVCA		
	AOHG09KVCA		AOHG12KVCA		AOHG14KVCA		AOHG14KVCA		
Power Source	Single phase, ~230 V, 50 Hz								
Capacity	Cooling	Rated	kW	2.5		3.5			
		Min.-Max.		0.9-3.5		0.9-4.0		0.9-5.2	
	Heating	Rated	3.5		4.5		5.2		
Min.-Max.		0.9-5.1		0.9-5.3		0.9-6.3			
Input Power	Cooling/Heating		kW	0.53/0.81		0.88/1.22		1.06/1.41	
EER	Cooling			4.70		4.00		3.95	
COP	Heating		W/W	4.30		3.70		3.70	
Pdesign	Cooling/Heating (-10°C)		kW	2.50/2.60		3.50/3.50		4.20/4.20	
SEER	Cooling		W/W	8.50		8.20		8.10	
SCOP	Heating (Average)		W/W	4.30		4.10		4.00	
Energy Efficiency Class	Cooling			A+++		A++		A+	
	Heating (Average)			A+		A+		A+	
Max. Operating Current	Cooling/Heating		A	7.0/8.5		7.0/8.5		11.0/12.0	
Annual Energy Consumption	Cooling		kWh/a	103		149		181	
	Heating (Average)		kWh/a	845		1,192		1,466	
Moisture Removal	Cooling		l/h	1.3		1.8		2.1	
	Heating		l/h	4.0/3.5/2.9/2.2		4.0/3.5/2.9/2.2		4.4/3.8/3.1/2.2	
Sound Pressure Level	Indoor (Cooling)		H/M/L/Q	41/35/29/22		41/35/29/22		43/37/29/22	
	Indoor (Heating)		H/M/L/Q	43/47		45/51		51/50	
Sound Power Level	Outdoor (Cooling/Heating)		High	53/54		53/54		57/56	
	Outdoor (Cooling/Heating)		High	58/61		61/64		63/63	
Airflow Rate	Indoor/Outdoor (Cooling)		High	570/1,530		570/1,530		650/2,210	
	Indoor/Outdoor (Heating)		High	600/1,510		600/1,510		650/2,100	
Net Dimensions H x W x D	Indoor		mm	600 x 740 x 200		600 x 740 x 200		600 x 740 x 200	
	Outdoor		mm	542 x 799 x 290		542 x 799 x 290		632 x 799 x 290	
Weight	Indoor		kg	14		14		14	
	Outdoor		kg	31		31		38	
Connection Pipe Diameter (Liquid/Gas)			mm	6.35/9.52		6.35/9.52		6.35/9.52	
Drain Hose Diameter (I.D./O.D.)			mm	13.8/15.8 to 16.7		13.8/15.8 to 16.7		13.8/15.8 to 16.7	
Max. Pipe Length (Pre-Charge)			m	20 (15)		20 (15)		20 (15)	
Max. Height Difference			m	15		15		15	
Operating Range	Cooling		°CDB	-10 to 46		-10 to 46		-10 to 46	
	Heating		°CDB	-15 to 24		-15 to 24		-15 to 24	
Refrigerant	Type (Global Warming Potential)			R32 (675)		R32 (675)		R32 (675)	
	Charge		kg (CO2eq-T)	0.85 (0.574)		0.85 (0.574)		0.94 (0.635)	

Optional parts

* For optional parts compatibility of Intesis devices, please refer to the optional parts compatibility list page C-050 to C-053 and C-066.

Wired Remote Controller (Design type):	UTY-RVRG	External switch controller:	UTY-TERX	Network Converter for single split (DC power supply type):	UTY-VTGX
Compact wired remote controller:	UTY-RCRGZ1	WLAN adapter:	UTY-TFSXZ1	Network Converter for single split (AC power supply type):	UTY-VTGXV
Wired remote controller (touch panel):	UTY-RNRGZ5		FG-AC-WIF1Z1	Silver Ion Filter:	UTR-FA03-5
Wired remote controller:	UTY-RLRG		UTY-TFSXJ3	External connect kit:	UTY-XWZX25
Simple remote controller (without operation mode):	UTY-RHRG	Half concealed kit:	UTR-STA		
Simple remote controller:	UTY-RSRG	Communication kit:	UTY-TWRXZ3		

Dimensions

(Unit: mm)

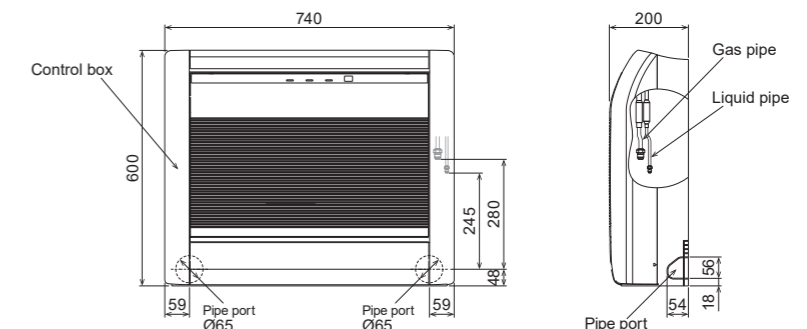

Ceiling



Light elegant design

The light-elegant, gently curved surface gives a sense of comfort and well-being.



Easy installation

The indoor unit can be easily installed under the ceiling thanks to the uniquely designed mounting kit.

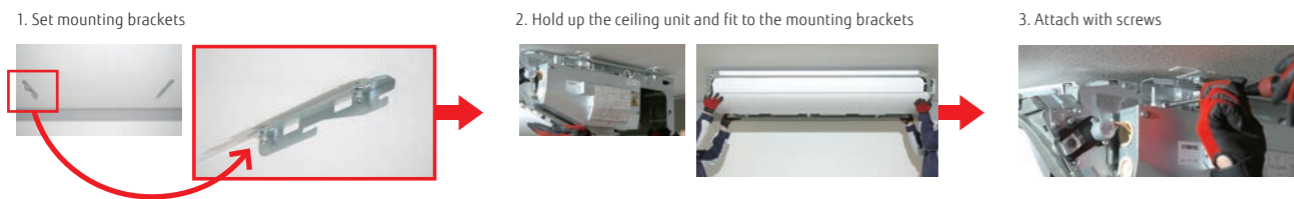

Easy maintenance

The front panel can be opened without removing it for safe & speedy maintenance.



The drain pan can be removed for cleaning.



Components in the control box can be easily accessed from the wide side opening.



Flexible installation

The drain hose and pipe can be contained in the casing and connected in the right, left, angled, or downward direction.



Link up with a variety of central control system (Option)

Centralized control including facilities and equipment in addition to air conditioning is possible by linking up with MODBUS, KNX interfaces.



Model: ABHG18KRTA / ABHG22KRTA / ABHG24KRTA / ABHG30KRTA / ABHG36KRTA / ABHG45KRTA / ABHG36KRTA [3-phase] / ABHG45KRTA [3-phase] / ABHG54KRTA [3-phase]



Specifications

Model name	Indoor unit						Outdoor unit				
	ABHG18KRTA	ABHG22KRTA	ABHG24KRTA	ABHG30KRTA	ABHG36KRTA	ABHG45KRTA	ABHG36KRTA	ABHG45KRTA	ABHG54KRTA		
Power Source	Single phase, ~230 V, 50 Hz						3-phase, ~400 V, 50 Hz				
Capacity	Cooling	Rated	5.2	6.0	6.8	8.5	9.5	12.1	9.5	12.1	13.4
		Min.-Max.	0.9-5.9	0.9-6.7	0.9-8.0	2.8-10.0	2.8-11.2	4.0-13.5	2.8-11.2	4.0-13.5	4.5-14.5
	Heating	Rated	6.0	7.0	7.5	10.0	10.8	13.5	10.8	13.5	15.5
Input Power	Cooling	Rated	0.9-7.5	0.9-8.0	0.9-9.1	2.7-11.2	2.7-12.7	4.2-16.2	2.7-12.7	4.2-16.2	4.7-16.5
		Min.-Max.	1.55/1.62	1.87/1.95	2.14/1.97	2.65/2.77	2.96/2.88	4.22/3.84	2.96/2.88	4.22/3.84	4.45/4.43
	Heating	Rated	3.35	3.21	3.18	3.21	3.21	2.87	3.21	2.87	3.01
EER	Cooling	Rated	3.70	3.59	3.81	3.61	3.75	3.52	3.75	3.52	3.50
		Min.-Max.	2.7-12.7	2.7-12.7	2.7-12.7	2.7-12.7	2.7-12.7	2.7-12.7	2.7-12.7	2.7-12.7	2.7-12.7
	Heating	Rated	5.2/4.4	6.0/4.8	6.8/6.0	8.5/8.0	9.5/8.7	-	9.5/8.7	-	-
Pdesign	Cooling/Heating (-10°C)	Rated	6.2	6.1	6.2	6.1	6.37	-	6.37	-	-
		Min.-Max.	4.1	4.0	4.1	4.0	4.21	-	4.21	-	-
	Heating (Average)	Rated	A++	A++	A++	A++	A++	-	A++	-	-
Energy Efficiency Class	Cooling	Rated	A+	A+	A+	A+	A+	-	A+	-	-
		Min.-Max.	12.1/12.1	12.6/12.6	13.6/13.6	22.6/22.6	22.6/22.6	28.5/28.5	10.5/10.5	14.0/14.0	14.0/14.0
	Heating (Average)	Rated	293	344	384	486	524	-	524	-	-
Max. Operating Current	Cooling/Heating	Rated	1.501	1.677	2.042	2.796	2.904	-	2.904	-	-
		Min.-Max.	2.0	2.5	2.2	3.0	2.6	4.5	2.6	4.5	5.0
	Heating (Average)	Rated	38/36/33/31	42/37/34/31	41/36/32/29	45/40/35/32	44/40/37/32	45/41/39/34	44/40/37/32	45/41/39/34	48/44/41/38
Sound Pressure Level	Indoor (Cooling)	H/M/L/Q	38/36/33/31	42/37/34/31	41/36/32/29	45/40/35/32	44/40/37/32	45/41/39/34	44/40/37/32	45/41/39/34	48/44/41/38
		High	50/50	51/51	53/54	53/55	55/55	57/57	55/55	57/57	57/59
	Outdoor (Cooling/Heating)	High	53/53	57/57	56/56	60/60	59/59	60/60	59/59	60/60	63/63
Sound Power Level	Indoor (Cooling/Heating)	High	62/62	63/63	65/66	68/69	70/70	71/71	70/70	71/71	73/73
		High	840/2,160	900/2,240	1,230/2,700	1,400/3,750	1,850/3,750	1,900/4,450	1,850/3,750	1,900/4,450	2,100/4,450
	Indoor/Outdoor (Cooling)	High	840/1,830	900/1,960	1,230/2,700	1,400/3,750	1,800/3,750	1,850/4,450	1,800/3,750	1,850/4,450	2,100/4,450
Airflow Rate	Indoor/Outdoor (Heating)	High	235 × 1,080 × 705	235 × 1,080 × 705	235 × 1,390 × 705	235 × 1,390 × 705	235 × 1,700 × 705	235 × 1,700 × 705	235 × 1,700 × 705	235 × 1,700 × 705	235 × 1,700 × 705
		High	632 × 799 × 290	632 × 799 × 290	716 × 820 × 315	788 × 940 × 320	788 × 940 × 320	998 × 940 × 320	788 × 940 × 320	998 × 940 × 320	998 × 940 × 320
	Indoor	mm	24	24	31	31	38	38	38	38	38
Net Dimensions	H × W × D	Indoor	36	38	42	52	52	67	53	67	67
		Outdoor	6.35/12.7	6.35/12.7	6.35/12.7	9.52/15.88	9.52/15.88	9.52/15.88	9.52/15.88	9.52/15.88	9.52/15.88
	Connection Pipe Diameter (Liquid/Gas)	mm	25/32	25/32	25/32	25/32	25/32	25/32	25/32	25/32	25/32
Max. Pipe Length (Pre-Charge)	Cooling	mm	30 (20)	30 (20)	30 (20)	50 (30)	50 (30)	50 (30)	50 (30)	50 (30)	50 (30)
		Heating	20	25	25	30	30	30	30	30	30
	Max. Height Difference	°CDB	-15 to 46	-15 to 46	-15 to 46	-15 to 46	-15 to 46	-15 to 46	-15 to 46	-15 to 46	-15 to 46
Operating Range	Cooling	°CDB	-15 to 24	-15 to 24	-15 to 24	-15 to 24	-15 to 24	-15 to 24	-15 to 24	-15 to 24	-15 to 24
		Heating	R32 (675)	R32 (675)	R32 (675)	R32 (675)	R32 (675)	R32 (675)	R32 (675)	R32 (675)	R32 (675)
	Refrigerant	Type (Global Warming Potential)	1.02 (0.689)	1.25 (0.844)	1.25 (0.844)	1.90 (1.283)	1.90 (1.283)	2.70 (1.823)	1.90 (1.283)	2.70 (1.823)	2.70 (1.823)
Refrigerant Charge	kg (CO2eq-T)	kg (CO2eq-T)	1.02 (0.689)	1.25 (0.844)	1.25 (0.844)	1.90 (1.283)	1.90 (1.283)	2.70 (1.823)	1.90 (1.283)	2.70 (1.823)	2.70 (1.823)
		kg (CO2eq-T)	1.02 (0.689)	1.25 (0.844)	1.25 (0.844)	1.90 (1.283)	1.90 (1.283)	2.70 (1.823)	1.90 (1.283)	2.70 (1.823)	2.70 (1.823)

Optional parts

* For optional parts compatibility of Intesis devices, please refer to the optional parts compatibility list page C-050 to C-053 and C-066.

Wired Remote Controller (Design type):	UTY-RVRG	WLAN adapter:	UTY-TFSXZ1	Network Converter for single split (DC power supply type):	UTY-VTGX
Compact wired remote controller:	UTY-RCRGZ1		UTY-TFSXJ3	Network Converter for single split (AC power supply type):	UTY-VTGVX
Wired remote controller (touch panel):	UTY-RNRGZ5		FG-AC-WIF1Z1	External switch controller:	UTY-TERX
Wired remote controller:	UTY-RLRG	Drain pump unit:	UTR-DPB24T	External connect kit:	UTY-XWZXZG
Simple remote controller (without operation mode):	UTY-RHRG	IR receiver unit:	UTY-LBTGH	(Outdoor unit 30/36/45/54)	
Simple remote controller:	UTY-RSRG	L-type piping kit:	UTP-FX24A (18/22/24)	External connect kit:	UTY-XWZXZ3
External input and output PCB:	UTY-XCSX		UTP-FX35A (30/36/45/54)		
External input and output PCB box:	UTZ-GXEA	Communication kit:	UTY-TWRXZ3		

Dimensions

(Unit: mm)

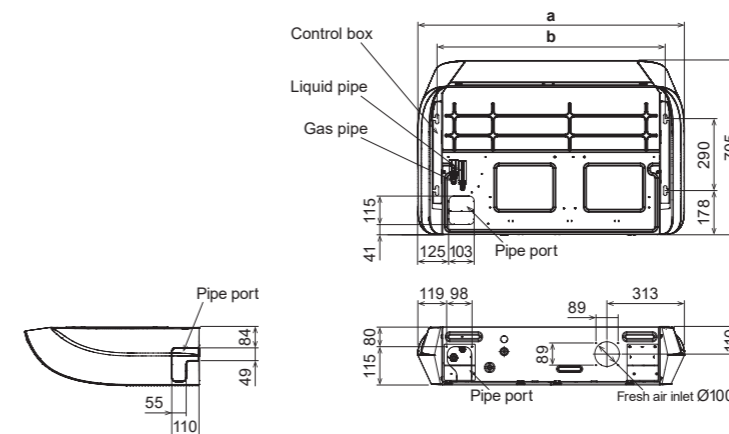

	ABHG 18/22KRTA	ABHG 24/30KRTA	ABHG 36/45/54 KRTA
a	1,080	1,390	1,700
b	923	1,233	1,543



Wall-mounted Specifications

Designer Series High-Spec & Design (WLAN adapter Internal Models)

Model name	Indoor unit		ASHG07KGTF	ASHG09KGTF	ASHG12KGTF	ASHG14KGTF
	Outdoor unit		AOHG07KGCB	AOHG09KGCB	AOHG12KGCB	AOHG14KGCB
Power Source						
Single phase, ~230 V, 50 Hz						
Capacity	Cooling	Rated	2.0	2.5	3.4	4.2
		Min.-Max.	0.9-3.2	0.9-3.4	0.9-4.1	0.9-4.5
	Heating	Rated	2.5	2.8	4.0	5.4
Min.-Max.		0.9-5.2	0.9-5.4	0.9-6.1	0.9-6.4	
Input Power	Cooling/Heating		0.400/0.500	0.555/0.560	0.805/0.910	1.175/1.350
EER	Cooling		5.00	4.50	4.22	3.57
COP	Heating		5.00	5.00	4.40	4.00
Pdesign	Cooling/Heating (-10°C)		2.0/2.3	2.5/2.4	3.4/2.5	4.2/4.0
SEER	Cooling		8.10	8.90	8.70	7.90
SCOP	Heating (Average)		5.30	5.20	5.20	4.50
Energy Efficiency Class	Cooling		A++	A+++	A+++	A++
	Heating (Average)		A+++	A+++	A+++	A+
Max. Operating Current	Cooling/Heating		6.5/9.0	6.5/9.0	6.5/9.0	9.0/10.5
Annual Energy Consumption	Cooling		86	98	137	186
	Heating		606	645	673	1,242
Moisture Removal			l/h	1.0	1.3	1.8
Sound Pressure Level	Indoor (Cooling)	H/M/L/Q	38/33/29/19	40/34/29/19	40/35/30/19	43/36/30/20
	Indoor (Heating)	H/M/L/Q	41/35/31/21	42/36/31/21	42/38/33/21	44/39/33/24
Sound Power Level	Outdoor (Cooling/Heating)	High	46/46	46/48	50/50	50/50
	Indoor (Cooling/Heating)	High	54/56	55/57	56/58	57/59
	Outdoor (Cooling/Heating)	High	61/62	61/63	65/66	65/66
	Indoor/Outdoor (Cooling)	High	650/1,610	700/1,610	700/1,680	770/1,680
Airflow Rate	Indoor/Outdoor (Heating)	High	720/1,560	750/1,610	770/1,580	800/1,580
			m³/h			
Net Dimensions H x W x D	Indoor		mm	270 × 834 × 215	270 × 834 × 215	270 × 834 × 215
	Outdoor		mm	542 × 799 × 290	542 × 799 × 290	542 × 799 × 290
Weight	Indoor		kg	10	10	10
	Outdoor		kg	30	30	31
Connection Pipe Diameter (Liquid/Gas)			mm	6.35/9.52		
Drain Hose Diameter (I.D./O.D.)			mm	13.8/15.0 to 16.8		
Max. Pipe Length (Pre-Charge)			m	20 (15)		
Max. Height Difference				15		
Operating Range	Cooling		°CDB	-10 to 46		
	Heating		°CDB	-15 to 24		
Refrigerant	Type (Global Warming Potential)			R32 (675)		
	Charge	kg (CO2eq-T)		0.75 (0.506)	0.75 (0.506)	0.85 (0.574)

Designer Series High Spec & Design (WLAN adapter Option Models)

Model name	Indoor unit		ASHG07KGTE	ASHG09KGTE	ASHG12KGTE	ASHG14KGTE
	Outdoor unit		AOHG07KGCA	AOHG09KGCA	AOHG12KGCA	AOHG14KGCA
Power Source						
Single phase, ~230 V, 50 Hz						
Capacity	Cooling	Rated	2.0	2.5	3.4	4.2
		Min.-Max.	0.9-3.2	0.9-3.4	0.9-4.1	0.9-4.5
	Heating	Rated	2.5	2.8	4.0	5.4
Min.-Max.		0.9-5.2	0.9-5.4	0.9-6.1	0.9-6.4	
Input Power	Cooling/Heating		0.400/0.500	0.555/0.560	0.805/0.910	1.175/1.350
EER	Cooling		5.00	4.50	4.22	3.57
COP	Heating		5.00	5.00	4.40	4.00
Pdesign	Cooling/Heating (-10°C)		2.0/2.3	2.5/2.4	3.4/2.5	4.2/4.0
SEER	Cooling		9.10	9.20	9.20	8.30
SCOP	Heating (Average)		5.30	5.20	5.20	4.50
Energy Efficiency Class	Cooling		A+++	A+++	A+++	A++
	Heating (Average)		A+++	A+++	A+++	A+
Max. Operating Current	Cooling/Heating		6.5/9.0	6.5/9.0	6.5/9.0	9.0/10.5
Annual Energy Consumption	Cooling		77	95	129	177
	Heating		607	645	672	1,242
Moisture Removal			l/h	1.0	1.3	1.8
Sound Pressure Level	Indoor (Cooling)	H/M/L/Q	38/33/29/19	40/34/29/19	40/35/30/19	43/36/30/20
	Indoor (Heating)	H/M/L/Q	41/35/31/21	42/36/31/21	42/38/33/21	44/39/33/24
Sound Power Level	Outdoor (Cooling/Heating)	High	46/46	46/48	50/50	50/50
	Indoor (Cooling/Heating)	High	54/56	55/57	56/58	57/59
	Outdoor (Cooling/Heating)	High	61/62	61/63	65/66	65/66
	Indoor/Outdoor (Cooling)	High	650/1,610	700/1,610	700/1,680	770/1,680
Airflow Rate	Indoor/Outdoor (Heating)	High	720/1,560	750/1,610	770/1,580	800/1,580
			m³/h			
Net Dimensions H x W x D	Indoor		mm	270 × 834 × 215	270 × 834 × 215	270 × 834 × 215
	Outdoor		mm	542 × 799 × 290	542 × 799 × 290	542 × 799 × 290
Weight	Indoor		kg	10	10	10
	Outdoor		kg	30	30	31
Connection Pipe Diameter (Liquid/Gas)			mm	6.35/9.52		
Drain Hose Diameter (I.D./O.D.)			mm	13.8/15.0 to 16.8		
Max. Pipe Length (Pre-Charge)			m	20 (15)		
Max. Height Difference				15		
Operating Range	Cooling		°CDB	-10 to 46		
	Heating		°CDB	-15 to 24		
Refrigerant	Type (Global Warming Potential)			R32 (675)		
	Charge	kg (CO2eq-T)		0.75 (0.506)	0.75 (0.506)	0.85 (0.574)

Designer Series
Cool Beauty Design



Model name	Indoor unit		ASHG07KETE ASHG07KETE-B	ASHG09KETE ASHG09KETE-B	ASHG12KETE ASHG12KETE-B	ASHG14KETE ASHG14KETE-B
	Outdoor unit		AOHG07KETA	AOHG09KETA	AOHG12KETA	AOHG14KETA
Power Source			Single phase, ~230 V, 50 Hz			
Capacity	Cooling	Rated	2.0	2.5	3.4	4.2
		Min.-Max.	0.9 - 3.0	0.9 - 3.2	0.9 - 3.9	0.9 - 4.4
Capacity	Heating	Rated	2.5	2.8	4.0	5.4
		Min.-Max.	0.9 - 3.4	0.9 - 4.0	0.9 - 5.3	0.9 - 6.0
Input Power	Cooling/Heating		0.450/0.555	0.630/0.620	0.935/0.960	1.220/1.410
EER	Cooling		4.43	3.97	3.65	3.44
COP	Heating		4.52	4.52	4.17	3.83
Pdesign	Cooling/Heating (-10°C)		2.0/2.3	2.5/2.4	3.4/2.5	4.2/4.0
SEER	Cooling		7.40	7.40	7.30	6.90
SCOP	Heating (Average)		4.10	4.10	4.40	4.10
Energy Efficiency Class	Cooling		A++	A++	A++	A++
	Heating (Average)		A+	A+	A+	A+
Max. Operating Current	Cooling/Heating		6.5/9.0	6.5/9.0	6.5/9.0	6.5/9.0
Annual Energy Consumption	Cooling		95	118	163	213
	Heating		785	819	795	1,367
Moisture Removal			1.0	1.3	1.8	2.1
Sound Pressure Level	Indoor (Cooling)	H/M/L/Q	38/33/29/20	40/34/29/20	40/35/30/20	43/36/30/20
	Indoor (Heating)	H/M/L/Q	41/35/31/22	42/36/31/22	42/38/33/22	44/39/33/24
Sound Power Level	Outdoor (Cooling/Heating)	High	46/46	46/46	50/50	50/50
	Indoor (Cooling/Heating)	High	54/56	55/57	55/58	57/59
Airflow Rate	Indoor/Outdoor (Cooling)	High	650/1,650	700/1,650	700/1,700	770/1,680
	Indoor/Outdoor (Heating)	High	720/1,450	750/1,450	770/1,470	800/1,580
Net Dimensions H x W x D	Indoor	mm	295 × 950 (wall side: 840) × 230			
Weight	Outdoor	mm	541 × 663 × 290	541 × 663 × 290	541 × 663 × 290	542 × 799 × 290
	Indoor	kg	11	11	11	11.5
Connection Pipe Diameter (Liquid/Gas)	Indoor	kg	23	23	25	31
	Outdoor	mm	6.35/9.52	6.35/9.52	6.35/9.52	6.35/9.52
Drain Hose Diameter (I.D./O.D.)			13.8/15.0 to 16.8	13.8/15.0 to 16.8	13.8/15.0 to 16.8	13.8/15.0 to 16.8
Max. Pipe Length (Pre-Charge)			20 (15)	20 (15)	20 (15)	20 (15)
Max. Height Difference			15	15	15	15
Operating Range	Cooling		-10 to 46	-10 to 46	-10 to 46	-10 to 46
	Heating		-15 to 24	-15 to 24	-15 to 24	-15 to 24
Refrigerant	Type (Global Warming Potential)		R32 (675)	R32 (675)	R32 (675)	R32 (675)
	Charge	kg (CO2eq-T)	0.6 (0.405)	0.6 (0.405)	0.7 (0.473)	0.85 (0.574)

Standard Series
High-Efficiency & Comfort



Model name	Indoor unit	W-LAN Adapter Internal Models	ASHG07KMCF	ASHG09KMCF	ASHG12KMCF	ASHG14KMCF
		W-LAN Adapter Option Models	ASHG07KMCE	ASHG09KMCE	ASHG12KMCE	ASHG14KMCE
		Outdoor unit	AOHG07KMCC	AOHG09KMCC	AOHG12KMCC	AOHG14KMCC
Power Source			Single phase, ~230 V, 50 Hz			
Capacity	Cooling	Rated	2.0	2.5	3.4	4.2
		Min.-Max.	0.9-3.0	0.9-3.2	0.9-3.9	0.9-4.4
Capacity	Heating	Rated	2.5	2.8	4.0	5.4
		Min.-Max.	0.9-3.4	0.9-4.0	0.9-5.3	0.9-6.0
Input Power	Cooling/Heating		0.450/0.555	0.630/0.620	0.935/0.960	1.220/1.410
EER	Cooling		4.43	3.97	3.65	3.44
COP	Heating		4.52	4.52	4.17	3.83
Pdesign	Cooling/Heating (-10°C)		2.0/2.3	2.5/2.4	3.4/2.5	4.2/4.0
SEER	Cooling		7.40	7.40	7.30	6.90
SCOP	Heating (Average)		4.10	4.10	4.40	4.10
Energy Efficiency Class	Cooling		A++	A++	A++	A++
	Heating (Average)		A+	A+	A+	A+
Max. Operating Current	Cooling/Heating		6.5/9.0	6.5/9.0	6.5/9.0	6.5/9.0
Annual Energy Consumption	Cooling		95	118	163	213
	Heating		785	819	795	1367
Moisture Removal			1.0	1.3	1.8	2.1
Sound Pressure Level	Indoor (Cooling)	H/M/L/Q	38/33/29/20	40/34/29/20	40/35/30/20	43/36/30/20
	Indoor (Heating)	H/M/L/Q	41/35/31/22	42/36/31/22	42/38/33/22	44/39/33/24
Sound Power Level	Outdoor (Cooling/Heating)	High	46/46	46/46	50/50	50/50
	Indoor (Cooling/Heating)	High	54/56	55/57	55/58	57/59
Airflow Rate	Indoor/Outdoor (Cooling)	High	650/1,650	700/1,650	700/1,700	770/1,680
	Indoor/Outdoor (Heating)	High	720/1,450	750/1,450	780/1,470	820/1,580
Net Dimensions H x W x D	Indoor	mm	270 × 834 × 222	270 × 834 × 222	270 × 834 × 222	270 × 834 × 222
Weight	Outdoor	mm	541 × 663 × 290	541 × 663 × 290	541 × 663 × 290	542 × 799 × 290
	Indoor	kg	10	10	10	10
Connection Pipe Diameter (Liquid/Gas)	Outdoor	kg	22	22	24	31
	Indoor	mm	6.35/9.52	6.35/9.52	6.35/9.52	6.35/9.52
Drain Hose Diameter (I.D./O.D.)			13.8/15.0 to 16.8	13.8/15.0 to 16.8	13.8/15.0 to 16.8	13.8/15.0 to 16.8
Max. Pipe Length (Pre-Charge)			20 (15)	20 (15)	20 (15)	20 (15)
Max. Height Difference			15	15	15	15
Operating Range	Cooling		-10 to 46	-10 to 46	-10 to 46	-10 to 46
	Heating		-15 to 24	-15 to 24	-15 to 24	-15 to 24
Refrigerant	Type (Global Warming Potential)		R32 (675)	R32 (675)	R32 (675)	R32 (675)
	Charge	kg (CO2eq-T)	0.6 (0.405)	0.6 (0.405)	0.7 (0.473)	0.85 (0.574)

ECO Series Lineup
Specifications



Compact Cassette



Model name	Indoor unit		AUXG09KVL A	AUXG12KVL A	AUXG14KVL A	AUXG18KVL A	AUXG22KVL A	AUXG24KVL A		
	Outdoor unit		AOHG09KAT A	AOHG12KAT A	AOHG14KAT A	AOHG18KAT A	AOHG22KAT A	AOHG24KAT A		
Power Source	Single phase, ~230 V, 50 Hz									
Capacity	Cooling	Rated	2.5	3.5	4.3	5.2	6.0	6.8		
		Min.-Max.	0.9-2.7	0.9-3.7	0.9-4.5	0.9-5.4	0.9-6.3	0.9-7.4		
Capacity	Heating	Rated	3.2	4.1	5.0	6.0	7.0	7.5		
		Min.-Max.	0.9-3.9	0.9-4.4	0.9-5.3	0.9-6.3	0.9-7.4	0.9-8.6		
Input Power	Cooling/Heating		kW		0.68/0.88	1.09/1.17	1.37/1.42	1.69/1.72	1.95/2.00	2.26/2.08
EER	Cooling		W/W		3.68	3.21	3.14	3.08	3.08	3.01
COP	Heating		W/W		3.64	3.50	3.52	3.49	3.50	3.61
Pdesign	Cooling/Heating (-10°C)		kW		2.5/2.3	3.5/2.8	4.3/3.2	5.2/3.8	6.0/4.4	6.8/5.4
SEER	Cooling		W/W		6.2	6.1	6.1	6.1	6.1	5.9
SCOP	Heating		W/W		4.0	4.0	4.0	3.9	3.9	3.8
Energy Efficiency Class	Cooling		A++		A++		A++		A+	
Max. Operating Current	Cooling/Heating		A		6.9/6.9	7.7/7.7	9.2/9.2	10.1/10.1	11.6/11.6	12.6/12.6
Annual Energy Consumption	Cooling		kWh/a		141	201	247	298	344	403
Moisture Removal	Heating		l/h		804	979	1,120	1,362	1,578	1,988
Sound Pressure Level	Indoor (Cooling)	H/M/L/Q	dB(A)		33/31/29/27	37/34/30/27	38/34/30/27	38/34/30/26	44/42/36/30	49/44/36/30
		Indoor (Heating)	H/M/L/Q	dB(A)		34/32/29/27	37/34/31/29	43/38/34/30	43/38/34/30	45/43/40/33
Sound Power Level	Outdoor (Cooling/Heating)	High	dB(A)		47/48	49/50	50/51	51/52	52/53	54/55
		High	dB(A)		46/47	49/49	50/55	50/55	56/57	59/61
Airflow Rate	Indoor/Outdoor (Cooling)	High	m³/h		540/1,610	600/1,630	680/1,670	680/1,710	830/2,240	930/2,885
		High	m³/h		540/1,550	600/1,410	800/1,580	800/1,840	860/2,240	930/2,350
Net Dimensions H x W x D	Indoor	mm	mm		245 x 570 x 570	245 x 570 x 570	245 x 570 x 570	245 x 570 x 570	245 x 570 x 570	245 x 570 x 570
		Outdoor	mm	mm		541 x 663 x 290	541 x 663 x 290	542 x 799 x 290	542 x 799 x 290	632 x 799 x 290
Weight	Indoor	kg	kg		15	15	15	15	16	16
		Outdoor	kg	kg		23	25	32	33	36
Connection Pipe Diameter (Liquid/Gas)	mm		mm		6.35/9.52	6.35/9.52	6.35/12.70	6.35/12.70	6.35/12.70	6.35/12.70
Drain port Diameter (I.D./O.D.)	mm		mm		25/32	25/32	25/32	25/32	25/32	25/32
Max. Pipe Length (Pre-Charge)	m		m		15 (15)	15 (15)	20 (15)	20 (15)	25 (15)	25 (20)
Max. Height Difference	°CDB		°CDB		15	15	15	15	20	20
Operating Range	Cooling	°CDB		°CDB		-10 to 46	-10 to 46	-10 to 46	-10 to 46	-10 to 46
		°CDB		°CDB		-15 to 24	-15 to 24	-15 to 24	-15 to 24	-15 to 24
Refrigerant	Type (Global Warming Potential)		kg (CO2eq-T)		R32 (675)	R32 (675)	R32 (675)	R32 (675)	R32 (675)	R32 (675)
	Charge		kg (CO2eq-T)		0.6 (0.405)	0.7 (0.473)	0.85 (0.574)	0.9 (0.608)	1.1 (0.743)	1.25 (0.844)
Cassette Grille	Model name		mm		mm		mm		mm	
	Dimensions (H x W x D)		mm		mm		mm		mm	
Cassette Grille	Weight		kg		kg		kg		kg	
	kg		kg		kg		kg		kg	

Circular Cassette (Slim type)



Model name	Indoor unit		AUXG18KRL B	AUXG22KRL B	AUXG24KRL B			
	Outdoor unit		AOHG18KAT A	AOHG22KAT A	AOHG24KAT A			
Power Source	Single phase, ~230 V, 50 Hz							
Capacity	Cooling	Rated	5.2	6.0	6.8			
		Min.-Max.	0.9-5.4	0.9-6.3	0.9-7.4			
Capacity	Heating	Rated	6.0	7.0	7.5			
		Min.-Max.	0.9-6.3	0.9-7.4	0.9-8.6			
Input Power	Cooling/Heating		kW		1.60/1.66	1.85/1.93	2.12/1.97	
EER	Cooling		W/W		3.25	3.24	3.21	
COP	Heating		W/W		3.61	3.63	3.81	
Pdesign	Cooling/Heating (-10°C)		kW		5.2/3.8	6.0/4.4	6.8/5.4	
SEER	Cooling		W/W		6.2	6.2	6.1	
SCOP	Heating		W/W		4.1	4.1	4.0	
Energy Efficiency Class	Cooling		A++		A++		A+	
Max. Operating Current	Cooling/Heating		A		10.1/10.1	11.6/11.6	12.6/12.6	
Annual Energy Consumption	Cooling		kWh/a		293	338	390	
Moisture Removal	Heating		l/h		1,297	1,502	1,887	
Sound Pressure Level	Indoor (Cooling)	H/M/L/Q	dB(A)		33/32/31/28	33/32/31/28	35/33/32/29	
		Indoor (Heating)	H/M/L/Q	dB(A)		33/32/31/28	33/32/31/28	35/33/32/29
Sound Power Level	Outdoor (Cooling/Heating)	High	dB(A)		51/52	52/53	54/55	
		High	dB(A)		47/47	49/49	49/49	
Airflow Rate	Indoor/Outdoor (Cooling)	High	m³/h		1,050/1,710	1,050/2,240	1,150/2,885	
		High	m³/h		1,050/1,840	1,050/2,240	1,150/2,350	
Net Dimensions H x W x D	Indoor	mm	mm		246 x 840 x 840	246 x 840 x 840	246 x 840 x 840	
		Outdoor	mm	mm		542 x 799 x 290	632 x 799 x 290	632 x 799 x 290
Weight	Indoor	kg	kg		23	24	24	
		Outdoor	kg	kg		33	36	38
Connection Pipe Diameter (Liquid/Gas)	mm		mm		6.35/12.70	6.35/12.70	6.35/12.70	
Drain port Diameter (I.D./O.D.)	mm		mm		25/32	25/32	25/32	
Max. Pipe Length (Pre-Charge)	m		m		20 (15)	25 (15)	25 (20)	
Max. Height Difference	°CDB		°CDB		15	20	20	
Operating Range	Cooling	°CDB		°CDB		-10 to 46	-10 to 46	
		°CDB		°CDB		-15 to 24	-15 to 24	
Refrigerant	Type (Global Warming Potential)		kg (CO2eq-T)		R32 (675)	R32 (675)	R32 (675)	
	Charge		kg (CO2eq-T)		0.9 (0.608)	1.1 (0.743)	1.25 (0.844)	
Cassette Grille	Model name		mm		mm		mm	
	Dimensions (H x W x D)		mm		mm		mm	
Cassette Grille	Weight		kg		kg		kg	
	kg		kg		kg		kg	

*1: IR Receiver kit and Human sensor kit cannot be connected.

Circular Cassette (Large type)



Model name	Indoor unit		AUXG30KRL B	AUXG36KRL B	AUXG45KRL B	AUXG54KRL B	AUXG36KRL B	AUXG45KRL B	AUXG54KRL B		
	Outdoor unit		AOHG30KAT A	AOHG36KAT A	AOHG45KAT A	AOHG54KAT A	AOHG36KAT A	AOHG45KAT A	AOHG54KAT A		
Power Source	Single phase, ~230 V, 50 Hz						3-phase, ~400 V, 50 Hz				
Capacity	Cooling	Rated	8.5	9.5	12.1	13.4	9.5	12.1	13.4		
		Min.-Max.	2.8-9.6	2.8-10.6	4.0-12.6	4.5-13.8	2.8-10.6	4.0-12.6	4.5-13.8		
Capacity	Heating	Rated	10.0	10.8	13.5	15.5	10.8	13.5	15.5		
		Min.-Max.	2.7-10.8	2.7-12.5	4.2-15.0	4.7-16.0	2.7-12.5	4.2-15.0	4.7-16.0		
Input Power	Cooling/Heating		kW		2.56/2.64	3.06/2.58	4.32/3.77	4.87/4.86	3.06/2.58	4.32/3.77	4.87/4.86
EER	Cooling		W/W		3.32	3.10	2.80	2.75	3.10	2.80	2.75
COP	Heating		W/W		3.79	4.19	3.58	3.19	4.19	3.58	3.19
Pdesign	Cooling/Heating (-10°C)		kW		8.5/8.0	9.5/8.7	-	-	9.5/8.7	-	-
SEER	Cooling		W/W		6.1	6.1	-	-	6.1	-	-
SCOP	Heating		W/W		4.0	4.0	-	-	4.0	-	-
Energy Efficiency Class	Cooling		A++		A++		A+		A+		
Max. Operating Current	Cooling/Heating		A		22.5/22.5	22.5/22.5	28.1/28.1	28.1/28.1	10.5/10.5	13.6/13.6	13.6/13.6
Annual Energy Consumption	Cooling		kWh/a		488	545	-	-	545	-	-
Moisture Removal	Heating		l/h		2,794	3,044	-	-	3,044	-	-
Sound Pressure Level	Indoor (Cooling)	H/M/L/Q	dB(A)		40/38/36/33	44/41/38/34	46/42/39/35	47/43/40/36	44/41/38/34	46/42/39/35	47/43/40/36
		Indoor (Heating)	H/M/L/Q	dB(A)		40/38/36/33	44/41/38/34	46/42/39/35	47/43/40/36	44/41/38/34	46/42/39/35
Sound Power Level	Outdoor (Cooling/Heating)	High	dB(A)		53/55	55/55	58/59	58/61	55/55	60/60	61/61
		High	dB(A)		54/54	58/58	60/60	61/61	58/58	-/-	-/-
Airflow Rate	Indoor/Outdoor (Cooling)	High	m³/h		1,600/3,750	1,870/3,750	2,000/4,450	2,100/4,450	1,870/3,750	2,000/4,450	2,100/4,450
		High	m³/h		1,600/3,750	1,870/3,750	2,000/4,450	2,100/4,780	1,870/3,750	2,000/4,450	2,100/4,780
Net Dimensions H x W x D	Indoor	mm	mm		288 x 840 x 840	288 x 840 x 840	288 x 840 x 840	288 x 840 x 840	288 x 840 x 840	288 x 840 x 840	288 x 840 x 840
		Outdoor	mm	mm		788 x 940 x 320	788 x 940 x 320	998 x 940 x 320	998 x 940 x 320	788 x 940 x 320	998 x 940 x 320
Weight	Indoor	kg	kg		26	29	29	29	29	29	
		Outdoor	kg	kg		52	52	61	63	53	62
Connection Pipe Diameter (Liquid/Gas)	mm		mm		9.52/15.88	9.52/15.88	9.52/15.88	9.52/15.88	9.52/15.88	9.52/15.88	
Drain port Diameter (I.D./O.D.)	mm		mm		25/32	25/32	25/32	25/32	25/32	25/32	
Max. Pipe Length (Pre-Charge)	m		m		30 (30)	30 (30)	30 (30)	30 (30)	30 (30)	30 (30)	
Max. Height Difference	°CDB		°CDB		30	30	30	30	30	30	
Operating Range	Cooling	°CDB		°CDB		-10 to 46	-10 to 46	-10 to 46	-10 to 46	-10 to 46	
		°CDB		°CDB		-15 to 24	-15 to 24	-15 to 24	-15 to 24	-15 to 24	
Refrigerant	Type (Global Warming Potential)		kg (CO2eq-T)		R32 (675)	R32 (675)	R32 (675)	R32 (675)	R32 (675)	R32 (675)	
	Charge		kg (CO2eq-T)		1.90 (1.283)	1.90 (1.283)	2.4 (1.620)	2.4 (1.620)	1.90 (1.283)	2.4 (1.620)	2.4 (1.620)
Cassette Grille	Model name		mm		mm		mm		mm		
	Dimensions (H x W x D)		mm		mm		mm		mm		
Cassette Grille	Weight		kg		kg		kg		kg		
	kg		kg		kg		kg		kg		

*1: IR Receiver kit and Human sensor kit cannot be connected.

Slim Duct



Model name	Indoor unit		ARXG09KLL AP	ARXG12KLL AP	ARXG14KLL AP	ARXG18KLL AP	
	Outdoor unit		AOHG09KAT A	AOHG12KAT A	AOHG14KAT A	AOHG18KAT A	
Power Source	Single phase, ~230 V, 50 Hz						
Capacity	Cooling	Rated	2.5	3.5	4.3	5.2	
		Min.-Max.	0.9-2.7	0.9-3.7	0.9-4.5	0.9-5.4	
Capacity	Heating	Rated	3.2	4.1	5.0	6.0	
		Min.-Max.	0.9-3.9	0.9-4.4	0.9-5.3	0.9-6.3	
Input Power	Cooling/Heating		kW		0.69/0.88	1.09/1.17	1.37/1.42

Medium Static Pressure Duct (High-Efficiency & Comfort)



Model name	Indoor unit		ARXH12KMTAP	ARXH14KMTAP	ARXH18KMTAP	ARXH22KMTAP	ARXH24KMTAP
	Outdoor unit		AOHG12KATA	AOHG14KATA	AOHG18KATA	AOHG22KATA	AOHG24KATA
Power Source	Single phase, ~230 V, 50 Hz						
Capacity	Cooling	Rated	3.5	4.3	5.2	6.0	6.8
		Min.-Max.	0.9-3.7	0.9-4.5	0.9-5.4	0.9-6.3	0.9-7.4
	Heating	Rated	4.1	5.0	6.0	7.0	7.5
		Min.-Max.	0.9-4.4	0.9-5.3	0.9-6.3	0.9-7.4	0.9-8.6
Input Power	Cooling/Heating	kW	1.060 / 1.170	1.340 / 1.420	1.730 / 1.820	1.85 / 1.97	2.06 / 1.97
EER	Cooling	W/W	3.30	3.21	3.00	3.24	3.30
COP	Heating	W/W	3.50	3.52	3.30	3.55	3.81
Pdesign	Cooling/Heating (-10°C)	kW	3.5 / 2.8	4.3 / 3.2	5.2 / 3.8	6.0 / 4.4	6.8 / 5.4
SEER	Cooling	W/W	6.00	5.80	5.90	6.00	6.00
SCOP	Heating (Average)	W/W	3.90	3.90	3.90	3.90	3.90
Energy Efficiency Class	Cooling		A+	A+	A+	A+	A+
	Heating (Average)		A	A	A	A	A
Max. Operating Current	Cooling/Heating	A	7.7 / 7.7	9.2 / 9.2	10.1 / 10.1	11.6 / 11.6	12.6 / 12.6
Annual Energy Consumption	Cooling	kWh/a	212	267	316	358	405
	Heating	kWh/a	1,005	1,148	1,363	1,578	1,936
Moisture Removal		l/h	1.3	1.3	2.0	1.5	2.2
Sound Pressure Level	Indoor (Cooling)	H/M/L/Q	29 / 27 / 25 / 23	32 / 29 / 27 / 25	33 / 30 / 28 / 26	32 / 28 / 25 / 24	34 / 30 / 28 / 26
	Indoor (Heating)	H/M/L/Q	29 / 27 / 25 / 23	32 / 29 / 27 / 25	33 / 30 / 28 / 26	32 / 28 / 25 / 24	34 / 30 / 28 / 26
Sound Power Level	Outdoor (Cooling/Heating)	High	49 / 50	50 / 51	51 / 52	52 / 53	54 / 55
	Indoor (Cooling/Heating)	High	58 / 58	59 / 59	60 / 60	58 / 58	60 / 60
Airflow Rate	Indoor/Outdoor (Cooling)	High	650 / 1,630	800 / 1,670	840 / 1,710	1,150 / 2,240	1,230 / 2,885
	Indoor/Outdoor (Heating)	High	650 / 1,410	800 / 1,580	840 / 1,840	1,150 / 2,240	1,230 / 2,350
Static pressure range (Standard)		Pa	30 to 150 (40)	30 to 150 (40)	30 to 150 (40)	30 to 150 (40)	30 to 150 (50)
Net Dimensions H x W x D	Indoor	mm	240 x 700 x 700	240 x 700 x 700	240 x 700 x 700	240 x 1,000 x 700	240 x 1,000 x 700
	Outdoor	mm	541 x 663 x 290	542 x 799 x 290	542 x 799 x 290	632 x 799 x 290	632 x 799 x 290
Weight	Indoor	kg	24	24	24	31	31
	Outdoor	kg	25	32	33	36	38
Connection Pipe Diameter (Liquid/Gas)		mm	6.35 / 9.52	6.35 / 9.52	6.35 / 12.7	6.35 / 12.70	6.35 / 12.70
Drain Hose Diameter (I.D./O.D.)		mm	25 / 32	25 / 32	25 / 32	25 / 32	25 / 32
Max. Pipe Length (Pre-Charge)		m	15 (15)	20 (15)	20 (15)	25 (15)	25 (20)
Max. Height Difference		m	15	15	15	20	20
Operating Range	Cooling	°CDB	-10 to 46	-10 to 46	-10 to 46	-10 to 46	-10 to 46
	Heating	°CDB	-15 to 24	-15 to 24	-15 to 24	-15 to 24	-15 to 24
Refrigerant	Type (Global Warming Potential)		R32 (675)	R32 (675)	R32 (675)	R32 (675)	R32 (675)
	Charge	kg (CO2eq-T)	0.70 (0.473)	0.85 (0.574)	0.90 (0.608)	1.10 (0.743)	1.25 (0.844)

Medium Static Pressure Duct (High-Efficiency & Comfort)



Model name	Indoor unit		ARXH30KMTAP	ARXH36KMTAP	ARXH45KMTAP	ARXH36KMTAP	ARXH45KMTAP
	Outdoor unit		AOHG30KATA	AOHG36KATA	AOHG45KATA	AOHG36KQTA	AOHG45KQTA
Power Source	Single phase, ~230 V, 50 Hz			3-phase, ~400 V, 50 Hz			
Capacity	Cooling	Rated	8.5	9.5	12.1	9.5	12.1
		Min.-Max.	2.8-9.6	2.8-10.6	4.0-12.6	2.8-10.6	4.0-12.6
	Heating	Rated	10.0	10.8	13.5	10.8	13.5
		Min.-Max.	2.7-10.8	2.7-12.5	4.2-15.0	2.7-12.5	4.2-15.0
Input Power	Cooling/Heating	kW	2.69 / 2.63	3.13 / 2.88	4.84 / 4.18	3.13 / 2.88	4.84 / 4.18
EER	Cooling	W/W	3.16	3.04	2.50	3.04	2.50
COP	Heating	W/W	3.80	3.75	3.23	3.75	3.23
Pdesign	Cooling/Heating (-10°C)	kW	8.5 / 8.0	9.5 / 8.7	-	9.5 / 8.7	-
SEER	Cooling	W/W	5.80	5.60	-	5.60	-
SCOP	Heating (Average)	W/W	3.90	3.90	-	3.90	-
Energy Efficiency Class	Cooling		A+	A+	-	A+	-
	Heating (Average)		A	A	-	A	-
Max. Operating Current	Cooling/Heating	A	22.5 / 22.5	22.5 / 22.5	28.1 / 28.1	10.5 / 10.5	13.6 / 13.6
Annual Energy Consumption	Cooling	kWh/a	520	601	-	601	-
	Heating	kWh/a	2,867	3,118	-	3,118	-
Moisture Removal		l/h	1.8	2.0	4.0	2.0	4.0
Sound Pressure Level	Indoor (Cooling)	H/M/L/Q	38 / 34 / 31 / 28	38 / 34 / 31 / 28	40 / 36 / 32 / 29	38 / 34 / 31 / 28	40 / 36 / 32 / 29
	Indoor (Heating)	H/M/L/Q	38 / 34 / 31 / 28	38 / 34 / 31 / 28	40 / 36 / 32 / 29	38 / 34 / 31 / 28	40 / 36 / 32 / 29
Sound Power Level	Outdoor (Cooling/Heating)	High	53 / 55	55 / 55	58 / 59	55 / 55	58 / 59
	Indoor (Cooling/Heating)	High	64 / 64	65 / 65	67 / 67	65 / 65	67 / 67
Airflow Rate	Indoor/Outdoor (Cooling)	High	1,950 / 3,750	2,070 / 3,750	2,160 / 4,450	2,070 / 3,750	2,160 / 4,450
	Indoor/Outdoor (Heating)	High	1,950 / 3,750	2,070 / 3,750	2,160 / 4,450	2,070 / 3,750	2,160 / 4,450
Static pressure range (Standard)		Pa	30 to 150 (50)	30 to 150 (50)	30 to 150 (60)	30 to 150 (50)	30 to 150 (60)
Net Dimensions H x W x D	Indoor	mm	240 x 1,400 x 700	240 x 1,400 x 700	240 x 1,400 x 700	240 x 1,400 x 700	240 x 1,400 x 700
	Outdoor	mm	788 x 940 x 320	788 x 940 x 320	998 x 940 x 320	788 x 940 x 320	998 x 940 x 320
Weight	Indoor	kg	42	42	42	42	42
	Outdoor	kg	52	52	61	53	62
Connection Pipe Diameter (Liquid/Gas)		mm	9.52 / 15.88	9.52 / 15.88	9.52 / 15.88	9.52 / 15.88	9.52 / 15.88
Drain Hose Diameter (I.D./O.D.)		mm	25 / 32	25 / 32	25 / 32	25 / 32	25 / 32
Max. Pipe Length (Pre-Charge)		m	30 (30)	30 (30)	30 (30)	30 (30)	30 (30)
Max. Height Difference		m	30	30	30	30	30
Operating Range	Cooling	°CDB	-10 to 46	-10 to 46	-10 to 46	-10 to 46	-10 to 46
	Heating	°CDB	-15 to 24	-15 to 24	-15 to 24	-15 to 24	-15 to 24
Refrigerant	Type (Global Warming Potential)		R32 (675)	R32 (675)	R32 (675)	R32 (675)	R32 (675)
	Charge	kg (CO2eq-T)	1.90 (1.283)	1.90 (1.283)	2.40 (1.620)	1.90 (1.283)	2.40 (1.620)

Medium Static Pressure Duct (Standard)









Model name	Indoor unit		ARXG22KMLB	ARXG24KMLA	ARXG30KMLA	ARXG36KMLA	ARXG45KMLA	ARXG36KMLA	ARXG45KMLA
	Outdoor unit		AOHG22KATA	AOHG24KATA	AOHG30KATA	AOHG36KATA	AOHG45KATA	AOHG36KQTA	AOHG45KQTA
Power Source	Single phase, ~230 V, 50 Hz							3-phase, ~400 V, 50 Hz	
Capacity	Cooling	Rated	6.0	6.8	8.5	9.5	12.1	9.5	12.1
		Min.-Max.	0.9-6.3	0.9-7.4	2.8-9.6	2.8-10.6	4.0-12.6	2.8-10.6	4.0-12.6
	Heating	Rated	7.0	7.5	10.0	10.8	13.5	10.8	13.5
		Min.-Max.	0.9-7.4	0.9-8.6	2.7-10.8	2.7-12.5	4.2-15.0	2.7-12.5	4.2-15.0
Input Power	Cooling/Heating	kW	1.92/2.00	2.19/2.00	2.78/2.77	3.13/3.03	4.84/4.18	3.13/3.03	4.84/4.18
EER	Cooling	W/W	3.13	3.11	3.06	3.04	2.50	3.04	2.50
COP	Heating	W/W	3.50	3.75	3.61	3.56	3.23	3.56	3.23
Pdesign	Cooling/Heating (-10°C)	kW	6.0/4.4	6.8/5.4	8.5/8.0	9.5/8.7	-	9.5/8.7	-
SEER	Cooling	W/W	5.8	5.9	5.8	5.6	-	5.6	-
SCOP	Heating (Average)	W/W	3.8	3.9	3.9	3.9	-	3.9	-
Energy Efficiency Class	Cooling		A+	A+	A+	A+	-	A+	-
	Heating		A	A	A	A	-	A	-
Max. Operating Current	Cooling/Heating	A	11.6/11.6	12.6/12.6	22.5/22.5	22.5/22.5	28.1/28.1	10.5/10.5	13.6/13.6
Annual Energy Consumption	Cooling	kWh/a	362	403	513	594	-	594	-
	Heating	kWh/a	1,620	1,935	2,871	3,122	-	3,122	-
Moisture Removal		l/h	2.1	2.5	2.5	3.0	4.0	3.0	4.0
Sound Pressure Level	Indoor (Cooling)	H/M/L/Q	31/29/27/25	31/29/27/25	39/35/30/26	39/35/30/26	42/38/32/28	39/35/30/26	42/38/32/28
	Indoor (Heating)	H/M/L/Q	31/29/27/25	31/29/27/25	42/35/30/26	42/35/30/26	42/38/32/28	42/35/30/26	42/38/32/28
Sound Power Level	Outdoor (Cooling/Heating)	High	52/53	54/55	53/55	55/55	58/59	55/55	58/59
	Indoor (Cooling/Heating)	High	60/62	60/62	65/69	65/70	68/70	65/70	68/70
Airflow Rate	Indoor/Outdoor (Cooling)	High	1,100/2,240	1,100/2,885	1,900/3,750	1,900/3,750	2,100/4,450	1,900/3,750	2,100/4,450
	Indoor/Outdoor (Heating)	High	1,100/2,240	1,100/2,350	2,100/3,750	2,100/3,750	2,100/4,450	2,100/3,750	2,100/4,450
Static pressure range (Standard)		Pa	30 - 150 (35)	30 - 150 (35)	30 - 150 (47)	30 - 150 (47)	30 - 150 (60)	30 - 150 (47)	30 - 150 (60)
Net Dimensions H x W x D	Indoor	mm	270 x 1,135 x 700	270 x 1,135 x 700	270 x 1,135 x 700	270 x 1,135 x 700	270 x 1,135 x 700	270 x 1,135 x 700	270 x 1,135 x 700
	Outdoor	mm	632 x 799 x 290	632 x 799 x 290	788 x 940 x 320	788 x 940 x 320	998 x 940 x 320	788 x 940 x 320	998 x 940 x 320
Weight	Indoor	kg	35	35	38	38	39	38	39
	Outdoor	kg	36	38	52	52	61	53	62
Connection Pipe Diameter (Liquid/Gas)		mm	6.35/12.70	6.35/12.70	9.52/15.88	9.52/15.88	9.52/15.88	9.52/15.88	9.52/15.88
Drain port Diameter (I.D./O.D.)		mm	25/32	25/32	25/32	25/32	25/32	35/38.1	35/38.1
Max. Pipe Length (Pre-Charge)		m	25 (15)	25 (20)	30 (30)	30 (30)	30 (30)	30 (30)	30 (30)
Max. Height Difference		m	20	20	30	30	30	30	30
Operating Range	Cooling	°CDB	-10 to 46	-10 to 46	-10 to 46	-10 to 46	-10 to 46	-10 to 46	-10 to 46
	Heating	°CDB	-15 to 24	-15 to 24	-15 to 24	-15 to 24	-15 to 24	-15 to 24	-15 to 24
Refrigerant	Type (Global Warming Potential)		R32 (675)	R32 (675)	R32 (675)	R32 (675)	R32 (675)	R32 (675)	R32 (675)
	Charge	kg (CO2eq-T)	1.1 (0.743)	1.25 (0.844)	1.90 (1.283)	1.90 (1.283)	2.4 (1.620)	1.9 (1.283)	2.4 (1.620)

Ceiling

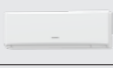

Model name	Indoor unit		ABHG18KRTA	ABHG22KRTA	ABHG24KRTA	ABHG30KRTA	ABHG36KRTA	ABHG45KRTA	ABHG36KRTA	ABHG45KRTA	
	Outdoor unit		AOHG18KATA	AOHG22KATA	AOHG24KATA	AOHG30KATA	AOHG36KATA	AOHG45KATA	AOHG36KQTA	AOHG45KQTA	
Power Source	Single phase, ~230 V, 50 Hz							3-phase, ~400 V, 50 Hz			
Capacity	Cooling	Rated	5.2	6.0	6.8	8.5	9.5	12.1	9.5	12.1	
		Min.-Max.									

Feature Summary

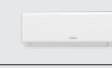
Type	Wall-mounted type				Wall-mounted type					
Series	Designer Range		Standard Range		Standard Range		ECO Range			
Model name										
	ASHH07/09/12/14KGTG, ASHG07/09/12/14KGTG, ASHG07/09/12/14KGTGTE	ASHG07/09/12/14KETF ASHG07/09/12/14KETF-B, ASHG07/09/12/14KETE ASHG07/09/12/14KETE-B	ASHH07/09/12/14KMCG, ASHG07/09/12/14KMCF, ASHG07/09/12/14KMCE	ASHG18/24KMTE	ASHH30/36KMTB	ASHH07/09/12KNCA	ASHG07/09/12KPCE	ASHG18/24KLCA	ASHH07/09/12KLTA	
Energy-Saving Features	Save Human sensor	●				●				
	Human sensor control									
	Economy operation	●	●	●	●	●	●	●	●	
	Setting temperature range limitation	○	○	○	○	○				
	Set temperature auto return	○	○	○	○	○				
Features for Comfort	Power diffuser									
	Powerful operation	●	●	●	●	●	●	●	●	
	10°C Heat	●	●	●	●	●	●			
	Outdoor unit low noise operation	●	●	●	●	●				
	Auto changeover	●	●	●	●	●	●	●	●	
	UP/DOWN swing louver	●	●	●	●	●	●	●	●	
	Double swing automatic				●	●				
	Automatic fan speed	●	●	●	●	●	●	●	●	
	Auto restart	●	●	●	●	●	●	●	●	
	Connectable fresh air duct									
	Fresh air intake									
	Connectable distributing duct									
	Individual airflow direction control									
	Convenience Features	Auto-off timer	○	○	○	○	○			
Sleep timer		●	●	●	●	●	●	●	●	
Program timer		●	●	●	●	●	●	●	●	
Weekly timer		●	●	○	●	●	● ^{*3}			
Weekly & Temperature setback timer		○	○	○	○	○				
Filter sign		●	●	●	●	●	●	●	●	
External error output		○	○	○	○	○				
External ON/OFF input		○	○	○	○	○				
Wireless LAN control		● (KGTG, KGTG) ○ (KGTGTE)	● (KETF, KETF-B) ○ (KETE, KETE-B)	● (KMCF, KMCG) ○ (KMCE)	○	○	●	○	○	
Multi system control						○				
Special cooling					● ^{*2}					
Clean Features	Ion deodorization filter	●	●	●	●	●				
	Apple-catechin filter	●	●	●	●	●				
	Long-life filter									
	Washable panel	●	●	●	●	●	●	●	●	
	Silver Ion Filter	○	○	○	○	○	○	○	○	
Installation Support	Automatic airflow adjustment									
	Drain pump as standard									
	Blue fin					●	●		●	
	Refrigerant cycle monitor	○ (KGTG)		○ (KMCG)		○	○		○	

*1 For details of Multi System Control function, refer to C-013.

*2 Wired remote controller (UTY-RNRGZ5) is required to use Special Cooling function.

*3: It is only available on the AIRSTAGE Mobile application and wired remote controller. It can not be used via wireless remote controller.

○: Optional function

Feature Summary

Type	Cassette		Duct			Duct				Floor	Ceiling
Series	Compact 4-way Flow Series	Circular Flow Series	Slim (With drain pump)	Medium Static Pressure (High-Efficiency & Comfort)	Medium Static Pressure (Compact size)	Medium Static Pressure (Standard)	High Static Pressure		Big		
Model name	AUXG 09/12/14/18/22/24 KVLA	AUXG 18/22/24/30/36/45/54 KRLB	ARXG 09/12/14/18 KLLAP	ARXH 12/14/18/22/24/30/36/45/54 KMTAP	ARXG 12/14/18/22/24/30/36/45/54 KHTAP	ARXG22KMLB ARXG24/30/36/45KMLA	ARXG45/54KHTB	ARHG60LHTA	ARHG72/90LHTA	AGHG09/12/14KVCA	ABHG 18/22/24/30/36/45/54 KRTA
Energy-Saving Features	Save Human sensor										
	Human sensor control		○								
	Economy operation	●	●	●	○	●	●	●	●	●	●
	Setting temperature range limitation	○	●	○	○	●	○	○	○	●	●
	Set temperature auto return	●	●	●	○	●	●	○	○	●	●
Features for Comfort	Power diffuser										
	Powerful operation									●	
	10°C Heat	●	○	○	○	○	○	○	○	●	○
	Outdoor unit low noise operation		○ (45/54)			○ (45/54)	○ (45) (36/LMLA)	○	○	●	○
	Auto changeover	●	●	●	●	●	●	●	●	●	●
	UP/DOWN swing louver	●	●	○						●	●
	Double swing automatic										
	Automatic fan speed	●	●	●	●	●	●	●	●	●	●
	Auto restart	●	●	●	●	●	●	●	●	●	●
	Connectable fresh air duct		●		●	●	●				●
	Fresh air intake	○	○	○	○	○	○	○	○	○	○
	Connectable distributing duct		●				●				
Individual airflow direction control		●									
Convenience Features	Auto-off timer	●	●	●	●	●	●	○	●	○	●
	Sleep timer	●	○	○	○	○	○	○	○	●	○
	Program timer	●	○	○	○	○	○	○	○	●	○
	Weekly timer	●	●	●	○	●	●		●	●	●
	Weekly & Temperature setback timer	○		●			●	●			
	Filter sign	●	●	●	●	●	●	●	●	●	●
	External error output		○		●	○		○	○	○	○
	External ON/OFF input	●	●	●	●	●	●	○	●	○	●
	Wireless LAN control	○	○	○	○	○	○	○	○	○	○
	Multi system control										
Special cooling											
Clean Features	Ion deodorization filter									●	
	Apple-catechin filter									●	
	Long-life filter				○	○	○	○	○		
	Washable panel										
Installation Support	Silver Ion Filter	○	○	○	○	○	○	○	○	○	○
	Automatic airflow adjustment				●	●			●		
	Drain pump as standard	●	●	●	●	●	○		○		○
	Blue fin		● (30/36/45/54)		● (30/36/45/54)	● (30/36/45/54)	● (30/36/45)	●	●	●	● (30/36/45/54)
	Refrigerant cycle monitor				○						

*1 For details of Multi System Control function, refer to C-013.

*2 Wired remote controller (UTY-RNRGZ5) is required to use Special Cooling function.

*3: It is only available on the AIRSTAGE Mobile application and wired remote controller. It can not be used via wireless remote controller.

○: Optional function



Light Commercial & Residential MULTI-SPLIT

- M-002 Multi-split Overview
- M-004 Multi-split Outdoor Units Lineup
- M-006 2-unit to 5-unit Multi-split Connectable Indoor Units
- M-008 6-unit Multi-split Connectable Indoor Units
- M-010 Simultaneous Multi-split Connectable Indoor Units
- M-044 Feature Summary



Refrigerant type R32 models

- M-012 2-unit to 5-unit Multi-split
 - M-018 Simultaneous Multi-split Twin/Triple
-
- M-022 2-unit to 5-unit Multi-split Indoor Units Specifications
-
- M-028 2-unit to 5-unit Multi-split Combination Table



Refrigerant type R410A models

- M-016 6-unit Multi-split
 - M-020 Simultaneous Multi-split Twin/Triple/Double Twin
-
- M-026 6-unit Multi-split Indoor Units Specifications
-
- M-038 6-unit Multi-split Combination Table



A single outdoor unit drives multiple indoor units, offering greater flexibility in system configuration.

If you wish to keep an entire floor or two or more rooms comfortable, we recommend you choose a multi-split air conditioning system with a single outdoor unit. Choose one that meets your air conditioning requirements from the variety of models we offer. You can mix and match indoor and outdoor units as you wish to build the system that best suits your needs.

Multi-split Overview

Multi-split's space-saving outdoor unit allows for connections of up to eight indoor units for multiple rooms. Added to the lineup are models compatible with the new R32 refrigerant, offering environmentally friendly comfort in homes, offices, stores, and various other settings.



3-unit, 4-unit, 5-unit Multi-split Types



3-unit 18/24 class



4-unit 30 class
5-unit 36 class



2-unit Multi-split



14 class



18 class

2-unit to 6-unit Multi-split

Recommended for residences, offices, and other situations where multiple rooms require air conditioning. Each of the 2 to 6 connected indoor units can also be operated individually. Operation control, time scheduling for each room, and energy-saving options can be set on both individual and central remote controllers. The outdoor unit is designed to save space and is flexible enough to be installed on a balcony or underneath a waist-high window.

6-unit Multi-split



6-unit 45 class

Twin / Triple



Twin 36 class
(Single-phase/3-phase)



Twin/Triple 45/54 class
(Single-phase/3-phase)



Twin / Triple / Double Twin



72/90 class
(3-phase)

Simultaneous Multi-split Type

Suitable for a small building, the entrance hall of a small office, meeting rooms, educational facilities, and other roomy areas where multiple indoor units need to be operated simultaneously. Up to 4 indoor units can be operated simultaneously, making the system perfect for air conditioning not only offices with large spaces, but also spaces with atypical layouts.

Multi-split Outdoor Units Lineup



FUJITSU GENERAL (Euro) GmbH participates in the ECP program for AC. Check ongoing validity of certificate: www.eurovent-certification.com *Models so marked are not ECC certified.

		Class	14	18	18	24	30	36	45		54	72	90
		Cooling rated capacity (kW)	4.0	5.0	5.4	6.8	8.0	10.0	12.5	14.0	14.0	19.0	22.0
2-unit, 3-unit, 4-unit, 5-unit Multi-split	2-unit Multi-split Up to 2 units		AOHG14KBT2	AOHG18KBT2									
	3-unit Multi-split Up to 3 units				AOHG18KBT3	AOHG24KBT3							
	4-unit Multi-split Up to 4 units						AOHG30KBT4						
	5-unit Multi-split Up to 5 units							AOHG36KBT5*1					
6-unit Multi-split	6-unit Multi-split Up to 6 units								AOHG45LBA6*				
Simultaneous Multi-split	Twin Single-phase							AOHG36KBTB	AOHG45KBTB				
	Twin 3-phase							AOHG36KRTA	AOHG45KRTA				
	Twin/Triple Single-phase										AOHG54KBTB		
	Twin/Triple 3-phase										AOHG54KRTA		
	Twin/Triple/Double Twin 3-phase											AOHG72LRLA	AOHG90LRLA

Notes: **1. 2-unit Multi-split:** Connectable indoor units are 2 units.
 AOHG14KBT2: Total capacity of indoor units connected must be between 4.0 kW and 6.0 kW.
 AOHG18KBT2: Total capacity of indoor units connected must be between 4.0 kW and 7.5 kW.
2. 3-unit Multi-split: Connectable indoor units are 2 to 3 units.
 AOHG18KBT3: Total capacity of indoor units connected must be between 4.0 kW and 8.5 kW.
 AOHG24KBT3: Total capacity of indoor units connected must be between 4.0 kW and 10.5 kW.

3. 4-unit Multi-split: Connectable indoor units are 2 to 4 units.
 AOHG30KBT4: Total capacity of indoor units connected must be between 7.5 kW and 14.0 kW.
4. 5-unit Multi-split: Connectable indoor units are 2 to 5 units.
 AOHG36KBT5: Total capacity of indoor units connected must be between 7.5 kW and 15.5 kW.

5. 6-unit Multi-split: Connectable indoor units are 2 to 6 units.
 AOHG45LBA6: Total capacity of indoor units connected must be between 9.5 kW and 18.0 kW.

Cooling rated capacity: *1: 9.5 kW

2-unit to 5-unit Multi-split Connectable Indoor Units



Type	2-unit		3-unit		4-unit	5-unit	
Model name	AOHG14KBT2	AOHG18KBT2	AOHG18KBT3	AOHG24KBT3	AOHG30KBT4	AOHG36KBT5	
Multi-split Type Outdoor Unit							
Capacity (kW)	Cooling	4.0	5.0	5.4	6.8	8.0	9.5
	Heating	4.4	5.6	6.8	8.0	9.6	10.6

Indoor Unit	BTU	kW Class	2-unit	3-unit	4-unit	5-unit
NEW ASHH07/09/12/14KGTG ASHG07/09/12/14KETE	7,000	2.0	●	●	●	●
	9,000	2.5	●	●	●	●
NEW ASHH07/09/12/14KMG ASHG07/09/12/14KETE-B	12,000	3.5	●	●	●	●
	14,000	4.0	—	●	●	●
NEW ASHH05/07/09/12KNCA	5,000	1.5	●*	●*	●*	●*
	7,000	2.0	●	●	●	●
	9,000	2.5	●	●	●	●
 ASHG18/22/24KMTE	12,000	3.5	●	●	●	●
	18,000	5.0	—	—	—	●
	22,000	6.0	—	—	—	●
 AGHG09/12/14KVCA	24,000	7.0	—	—	—	●
	9,000	2.5	●	●	●	●
	12,000	3.5	●	●	●	●
 AUXG07/09/12/14/18/22KVLA	14,000	4.0	—	●	●	●
	7,000	2.0	●	●	●	●
	9,000	2.5	●	●	●	●
	12,000	3.5	●	●	●	●
	18,000	5.0	—	—	—	●
22,000	6.0	—	—	—	●	

*Please consult your dealer for compatible outdoor units with 5kW models.



Type	2-unit		3-unit		4-unit	5-unit	
Model name	AOHG14KBT2	AOHG18KBT2	AOHG18KBT3	AOHG24KBT3	AOHG30KBT4	AOHG36KBT5	
Multi-split Type Outdoor Unit							
Capacity (kW)	Cooling	4.0	5.0	5.4	6.8	8.0	9.5
	Heating	4.4	5.6	6.8	8.0	9.6	10.6

Indoor Unit	BTU	kW Class	2-unit	3-unit	4-unit	5-unit
 ARXG07/09/12/14/18KSLAP	7,000	2.0	●	●	●	●
	9,000	2.5	●	●	●	●
	12,000	3.5	●	●	●	●
	14,000	4.0	—	●	●	●
	18,000	5.0	—	—	—	●
 ARXG07/09/12/14/18KLLAP	7,000	2.0	●	●	●	●
	9,000	2.5	●	●	●	●
	12,000	3.5	●	●	●	●
	14,000	4.0	—	●	●	●
	18,000	5.0	—	—	—	●
NEW ARXH12/14/18/22KMTAP	12,000	3.5	●	●	●	●
	14,000	4.0	—	●	●	●
	18,000	5.0	—	—	—	●
 ARXG22KMLB	22,000	6.0	—	—	—	●
	18,000	5.0	—	—	—	●
 ABHG18/22KRTA	22,000	6.0	—	—	—	●
	18,000	5.0	—	—	—	●

6-unit Multi-split Connectable Indoor Units



Type	6-unit	
Model name	AOHG45LBLA6	
Multi-split Type Outdoor Unit		
Capacity (kW)	Cooling	12.5
	Heating	13.5

Indoor Unit	BTU	kW Class	
 ASHG07/09/12/14LMCA	7,000	2.0	●
	9,000	2.5	●
 ASHG07/09/12/14LUCA	12,000	3.5	●
	14,000	4.0	●
 ASHG18/24LF	18,000	5.0	●
	24,000	7.0	●
 AGHG09/12/14LV	9,000	2.5	●
	12,000	3.5	●
	14,000	4.0	●
 AUHG07/09/12/14/18LV	7,000	2.0	●
	9,000	2.5	●
	12,000	3.5	●
	14,000	4.0	●
 ABHG14LVTA ABHG18LVTB	14,000	4.0	●
	18,000	5.0	●
 ARHG07/09/12/14/18SLAP	7,000	2.0	●
	9,000	2.5	●
	12,000	3.5	●
	14,000	4.0	●
 ARHG07/09/12/14/18LL	18,000	5.0	●
	7,000	2.0	●
	9,000	2.5	●
	12,000	3.5	●
 ARHG07/09/12/14/18LL	14,000	4.0	●
	18,000	5.0	●

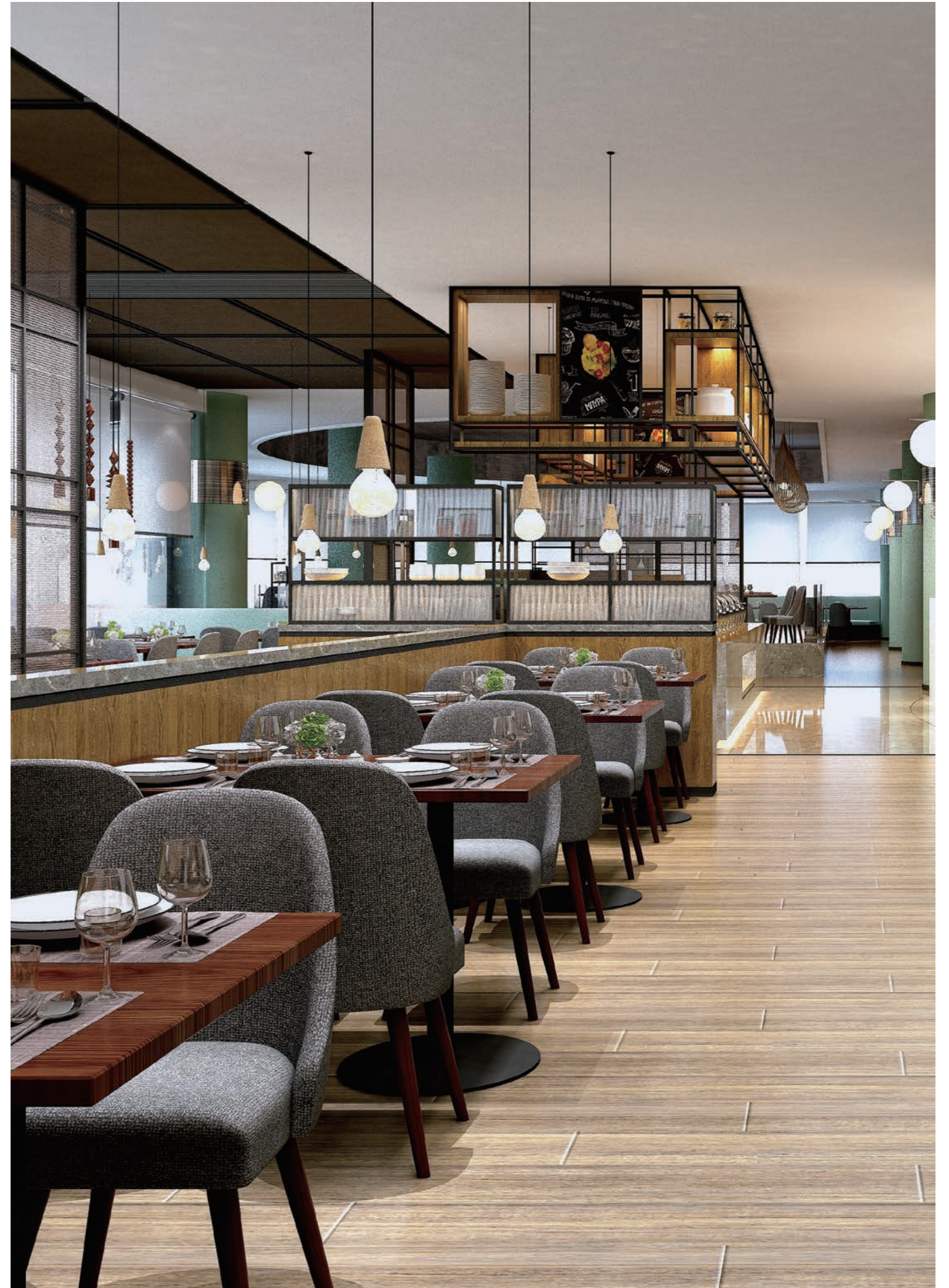

Simultaneous Multi-split Connectable Indoor Units



Type	4HP		5HP		6HP	
Model name	AOHG36KBTB	AOHG36KRTA	AOHG45KBTB	AOHG45KRTA	AOHG54KBTB	AOHG54KRTA
Simultaneous Multi-split Type Outdoor Unit						
Capacity (kW)	Cooling	9.5	12.1	13.4	13.4	
	Heating	10.8	13.5	15.5	15.5	

Indoor Unit	BTU	kW Class	Twin			Triple
			● × 2	● × 2	● × 2	● × 3
 AUXG18/22/24KVLA	18,000	5.0	● × 2	-	-	● × 3
	22,000	6.5	-	● × 2	-	-
	24,000	7.0	-	-	● × 2	-
 ARXG18KLLAP	18,000	5.0	● × 2	-	-	● × 3
	22,000	6.5	-	● × 2	-	-
 ARXG22KMLB ARXG24KMLA	24,000	7.0	-	-	● × 2	-
	Separation tube			UTP-SX236A (18/22/24)		UTP-SX354A (18)

Note : Please be aware that 2-wired group control is not possible with Simultaneous Multi-split.



Type	8HP	10HP
Model name	AOHG72LRLA	
Simultaneous Multi-split Outdoor Unit		
Capacity (kW)	Cooling	19.0
	Heating	22.4

Indoor Unit	BTU	kW Class	Twin	Triple	Double Twin	Twin	Triple	Double Twin
			● × 2	● × 3	● × 4	● × 2	● × 3	● × 4
 AUHG18/22/24LV	18,000	5.0	-	-	● × 4	-	-	-
	22,000	6.5	-	-	-	-	-	● × 4
	24,000	7.0	-	● × 3	-	-	-	-
 AUHG30/36/45LR	30,000	8.8	-	-	-	-	● × 3	-
	36,000	10.6	● × 2	-	-	-	-	-
	45,000	12.5	-	-	-	● × 2	-	-
 ARHG18LLTB	18,000	5.0	-	-	● × 4	-	-	-
	22,000	6.5	-	-	-	-	-	● × 4
 ARHG22/24/30/36/45LM	24,000	7.0	-	● × 3	-	-	-	-
	30,000	8.8	-	-	-	-	● × 3	-
	36,000	10.6	● × 2	-	-	-	-	-
	45,000	12.5	-	-	-	● × 2	-	-
 ABHG18/22/24LV	18,000	5.0	-	-	● × 4	-	-	-
	22,000	6.5	-	-	-	-	-	● × 4
	24,000	7.0	-	● × 3	-	-	-	-
 ABHG30/36/45LR	30,000	8.8	-	-	-	-	● × 3	-
	36,000	10.6	● × 2	-	-	-	-	-
	45,000	12.5	-	-	-	● × 2	-	-
Separation tube			UTP-SX272A × 1	UTP-SX372A × 1	UTP-SX272A × 1, UTP-SX236A × 2	UTP-SX272A × 1	UTP-SX372A × 1	UTP-SX272A × 1, UTP-SX254A × 2

2-unit,
3-unit,
4-unit,
5-unit,
Multi-split



High energy saving

With the adoption of a high-efficiency DC twin-rotary compressor, all models achieved an energy efficiency scale of A+++ for cooling and A++ for heating.

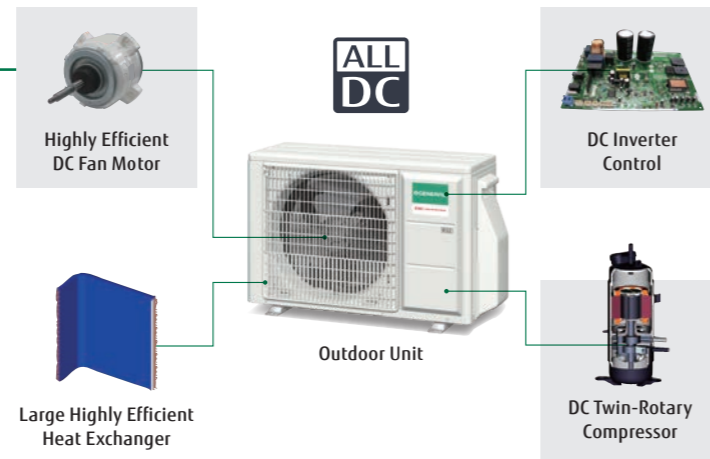
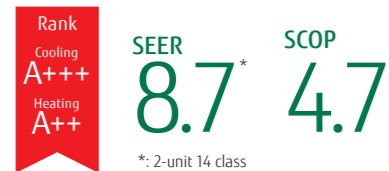

R32 refrigerant model

In addition to its high energy efficiency, the R32 refrigerant has a larger volumetric capacity than the R410A refrigerant, which means the R32 refrigerant models require less refrigerant charge than the R410A models.

	Pre-charge refrigerant amount (kg)	
	R32	R410A
2-unit 14 class	0.9	1.25
2-unit 18 class	1.02	1.30
3-unit 18 class	1.8	2.2
3-unit 24 class	1.8	2.2
4-unit 30 class	2.2	3.3
5-unit 36 class	2.5	4.0

Quiet operation

The sound power level is reduced by up to 7 dB compared to the current R410 models.

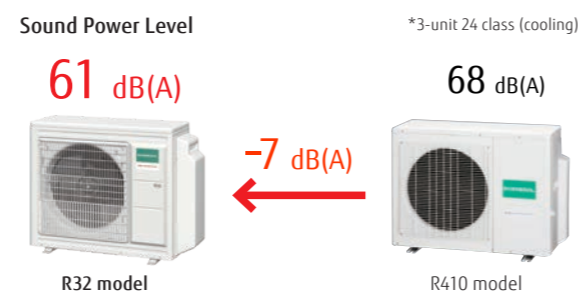

Space-saving installation

Multiple indoor units can be connected to 1 outdoor unit by long piping as well. Unlike a single type, the outdoor unit can be installed in the most space-saving location.



Compact design

Unlike a single type, the outdoor unit can be installed in the most space-saving location.

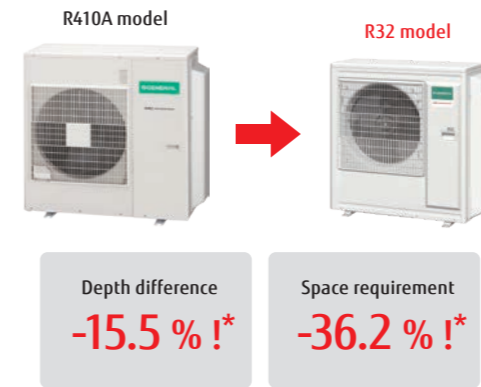

*: Compared with current 5-unit multi models

Easy evacuation

All connected pipes and indoor units can be evacuated quickly via our centralized valve method. Requires evacuation only once.

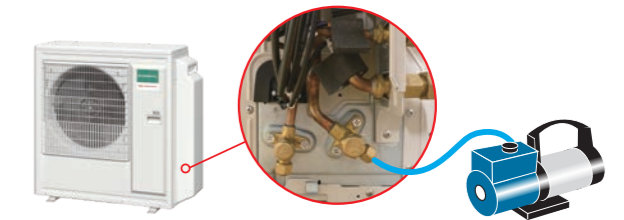

Wide range of indoor units with various models

We offer 41 models in 5 types in a capacity range from 2.0 kW to 6.0 kW. Wide range of requirements can be realized from private homes through to large shops and hotels



Models equipped with the New R32 Refrigerant

Wall-mounted type with sophisticated design



Middle and small capacity models are available. This makes installation easier in small spaces.



2-unit: AOHG14KBTA2 / AOHG18KBTA2
 3-unit: AOHG18KBTA3 / AOHG24KBTA3
 4-unit: AOHG30KBTA4
 5-unit: AOHG36KBTA5



Specifications (2-unit)

Model name		AOHG14KBTA2		AOHG18KBTA2	
Power Source					
Single phase, ~230 V, 50 Hz					
Rated Capacity	Cooling	Rated Min.-Max. Rated	kW	4.0	5.0
	Heating	Rated Min.-Max. Rated		1.4-4.6	1.7-5.8
EER	Cooling	Rated	W/W	4.4	5.6
	Heating	Rated		1.1-5.5	1.8-6.6
COP	Cooling	Rated	W/W	4.12	4.03
	Heating	Rated		4.63	4.59
Sound Pressure Level (High)	Cooling	Rated	dB(A)	47	47
	Heating	Rated		49	50
Sound Power Level (High)	Cooling	Rated	dB(A)	60	60
	Heating	Rated		62	62
Airflow Rate	Cooling/Heating	Rated	m ³ /h	1,670/1,670	1,960/2,020
Net Dimensions H × W × D		mm		542 × 799 × 290	632 × 799 × 290
Weight		kg		33	37
Connection Pipe Diameter	Liquid	mm		6.35 × 2	6.35 × 2
	Gas	mm		9.52 × 2	9.52 × 2
Max. Pipe Length		m		30/20	30/20
Max. Height Difference	Between Outdoor Unit and Each Indoor Unit	m		15	15
	Between Indoor Units	m		10	10
Operating Range	Cooling	°CDB		-10 to 46	-10 to 46
	Heating	°CDB		-15 to 24	-15 to 24
Refrigerant	Type (Global Warming Potential)	kg (CO ₂ eq-T)		R32 (675)	R32 (675)
	Charge	kg (CO ₂ eq-T)		0.9 (0.608)	1.02 (0.689)

Specifications (3-unit)

Model name		AOHG18KBTA3		AOHG24KBTA3	
Power Source					
Single phase, ~230 V, 50 Hz					
Rated Capacity	Cooling	Rated Min.-Max. Rated	kW	5.4	6.8
	Heating	Rated Min.-Max. Rated		1.8-7.0	1.8-8.5
EER	Cooling	Rated	W/W	6.8	8.0
	Heating	Rated		2.0-8.0	2.0-9.2
COP	Cooling	Rated	W/W	4.78	3.90
	Heating	Rated		4.89	4.40
Sound Pressure Level (High)	Cooling	Rated	dB(A)	46	48
	Heating	Rated		49	53
Sound Power Level (High)	Cooling	Rated	dB(A)	59	61
	Heating	Rated		61	67
Airflow Rate	Cooling/Heating	Rated	m ³ /h	2,220/2,160	2,270/2,730
Net Dimensions H × W × D		mm		716 × 820 × 315	716 × 820 × 315
Weight		kg		46	46
Connection Pipe Diameter	Liquid	mm		6.35 × 3	6.35 × 3
	Gas	mm		9.52 × 3	9.52 × 2, 12.70 × 1 adapter [12.70 → 9.52] × 1
Max. Pipe Length		m		50/25	50/25
Max. Height Difference	Between Outdoor Unit and Each Indoor Unit	m		15	15
	Between Indoor Units	m		10	10
Operating Range	Cooling	°CDB		-10 to 46	-10 to 46
	Heating	°CDB		-15 to 24	-15 to 24
Refrigerant	Type (Global Warming Potential)	kg (CO ₂ eq-T)		R32 (675)	R32 (675)
	Charge	kg (CO ₂ eq-T)		1.8 (1.215)	1.8 (1.215)

Specifications (4-unit, 5-unit)

Model name		AOHG30KBTA4		AOHG36KBTA5	
Power Source					
Single phase, ~230 V, 50 Hz					
Rated Capacity	Cooling	Rated Min.-Max. Rated	kW	8.0	9.5
	Heating	Rated Min.-Max. Rated		2.4-10.1	3.0-11.0
EER	Cooling	Rated	W/W	9.6	10.6
	Heating	Rated		3.0-11.2	3.5-12.0
COP	Cooling	Rated	W/W	4.55	4.50
	Heating	Rated		5.0	5.2
Sound Pressure Level (High)	Cooling	Rated	dB(A)	54	55
	Heating	Rated		63	65
Sound Power Level (High)	Cooling	Rated	dB(A)	66	68
	Heating	Rated		66	68
Airflow Rate	Cooling/Heating	Rated	m ³ /h	2,400/2,950	2,450/2,900
Net Dimensions H × W × D		mm		884 × 820 × 315	884 × 820 × 315
Weight		kg		55	59
Connection Pipe Diameter	Liquid	mm		6.35 × 4	6.35 × 5
	Gas	mm		9.52 × 2, 12.70 × 2 adapter [12.70 → 9.52] × 2	9.52 × 3, 12.70 × 2 adapter [12.70 → 9.52] × 2 adapter [9.52 → 12.70] × 1
Max. Pipe Length*		m		70/25	75/25
Max. Height Difference	Between Outdoor Unit and Each Indoor Unit	m		15	15
	Between Indoor Units	m		10	10
Operating Range	Cooling	°CDB		-10 to 46	-10 to 46
	Heating	°CDB		-15 to 24	-15 to 24
Refrigerant	Type (Global Warming Potential)	kg (CO ₂ eq-T)		R32 (675)	R32 (675)
	Charge	kg (CO ₂ eq-T)		2.2 (1.485)	2.5 (1.688)

*Length not applicable when floor units are connected. For details, refer to the installation manual.

Dimensions

(Unit: mm)

2-unit: AOHG14KBTA2

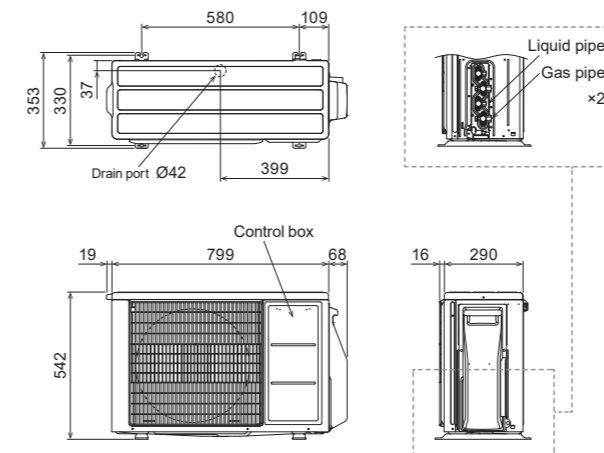

2-unit: AOHG18KBTA2

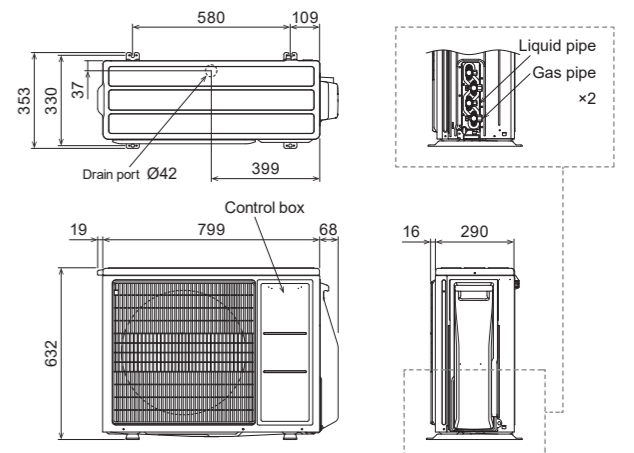

3-unit: AOHG18KBTA3 / AOHG24KBTA3

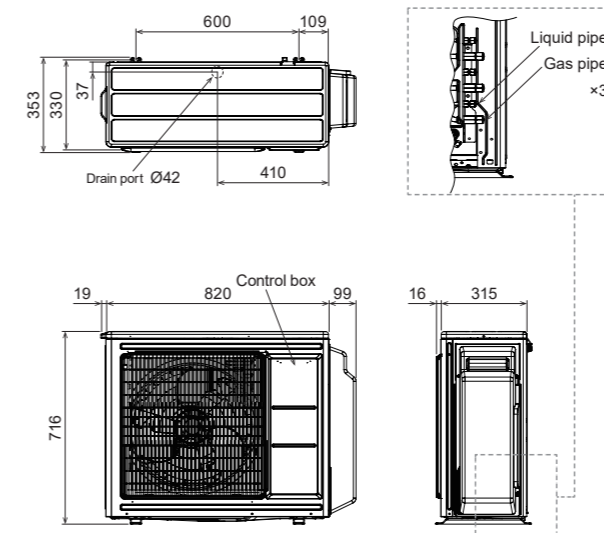

4-unit: AOHG30KBTA4
5-unit: AOHG36KBTA5

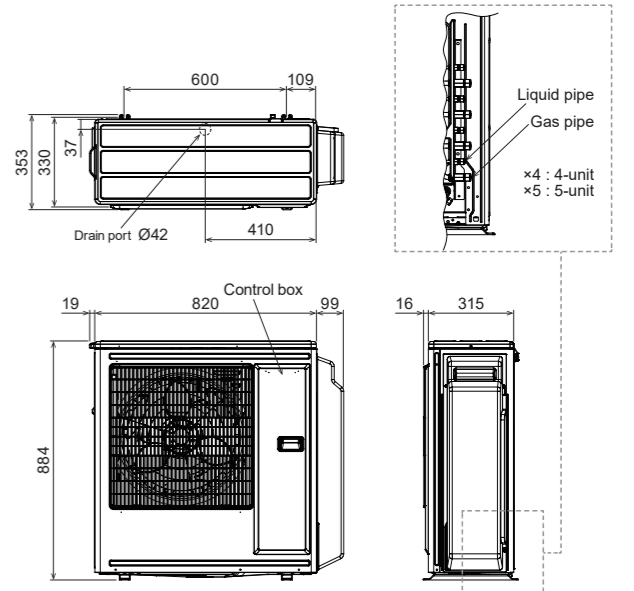

6-unit Multi-split



6-unit: AOHG45LBA6



Specifications

Model name				AOHG45LBA6	
Power Source				Single phase, ~230 V, 50 Hz	
Rated Capacity	Cooling	Rated	kW	12.5	
		Min.-Max.		3.5-14.0	
	Heating	Rated	kW	13.5	
		Min.-Max.		3.5-16.0	
EER	Cooling	W/W	3.50		
COP	Heating		4.00		
Sound Pressure Level (High)	Cooling	dB(A)	53		
	Heating		55		
Sound Power Level (High)	Cooling	-	-		
	Heating		-		
Airflow Rate	Cooling/Heating	m ³ /h	4,200/4,200		
Net Dimensions H × W × D				mm	
Weight				kg	
Connection Pipe Diameter	Liquid	mm	6.35 × 6		
	Gas		9.52 × 4, 12.70 × 2		
Max. Pipe Length	Total/Each		80/25		
	Between Outdoor Unit and Each Indoor Unit.		15		
Max. Height Difference	Between Indoor Units.		10		
	Operating Range		°CDB		
Refrigerant	Type (Global Warming Potential)		R410A (2,088)		
	Charge	kg (CO ₂ eq-T)	4.00 (8.352)		

A wide variety of models to choose from

We offer 26 models in 5 types in a capacity range from 2.0 kW to 7.0 kW. Wide range of requirements can be realized from private homes through to large shops and hotels.

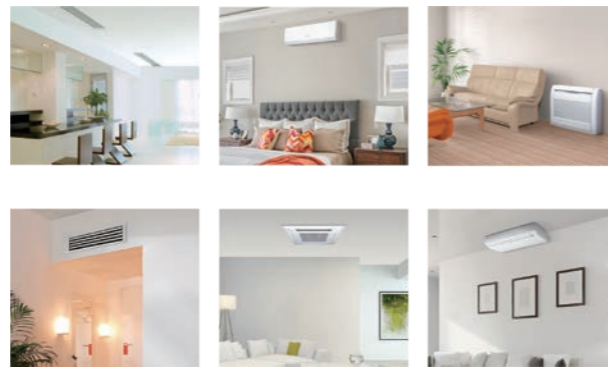

Compact design

Multiple indoor units can be connected to 1 outdoor unit by long piping as well. Unlike a single type, the outdoor unit can be installed in the most space-saving location.



Easy installation

All connected pipes and indoor units can be evacuated quickly via our centralized valve method. Requires evacuation only once.

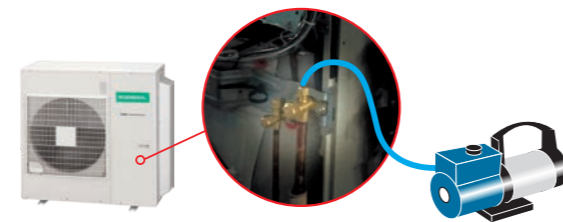

Central & Individual control

- Batched control of up to 6 indoor units. Unified setting of room temperature, airflow volume, and local control restrictions across units.
- Language can be selected from English, French, German, Greek, Italian, Portuguese, Russian, Spanish, or Turkish.
- Large backlit LED screen
- Large easy-to-see operation panel

Max. Controllable
1 multi-system
Max. Controllable
6 indoor units



Dimensions

(Unit: mm)

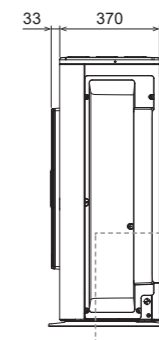
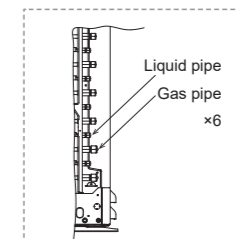
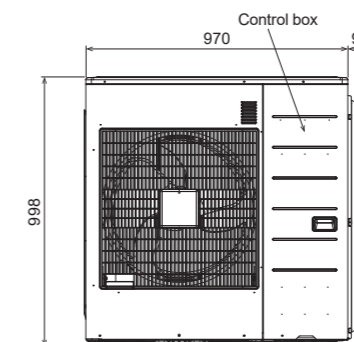
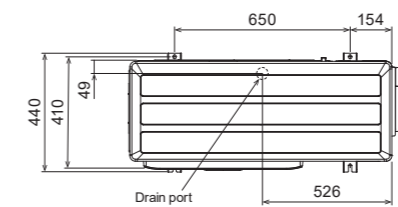

Simultaneous Multi-split Type

Twin / Triple



Meets a variety of installation needs from offices to commercial spaces, with up to 3 indoor units in the same room connected to an outdoor unit.

Select indoor units according to floor layout and heat load estimated by the number of people working in the room and the direction and intensity of sunlight entering the room. Perfect airflow distribution can be achieved for optimum comfort.

Installation according to floor layout

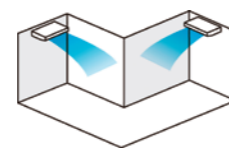

Installation according to lighting conditions

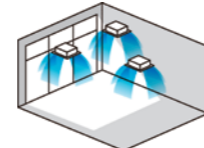

Design flexibility

Slim & Compact Design

The outdoor unit in this series is 22.7% shorter* than a twin-fan outdoor unit. The reduced height makes it easy to install in tight spaces.

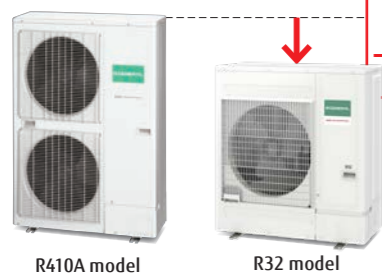

Height -22.7%*
 (*: Applicable to the 45,000- and 54,000-BTU models)

Flexible installation

Pipe length of up to 50 m and a height difference of up to 30 m can be accommodated. Multi-split systems can be installed in large residences and multi-story buildings.

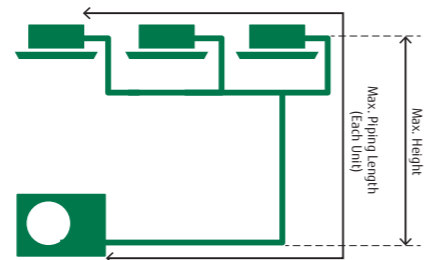

Max. Pipe Length (Each Unit): **50 m**
 Max. Height: **30 m**

New lineup of indoor units

The indoor units, available in 6 models of 3 types, can be selected according to room size and conditions.



Note : Please be aware that 2-wired group control is not possible with Simultaneous Multi-split.

Model: AOHG36KBTB / AOHG45KBTB / AOHG54KBTB
 AOHG36KRTA [3-phase] / AOHG45KRTA [3-phase] / AOHG54KRTA [3-phase]



Specifications (Indoor units/Outdoor units)

Indoor Units Model name	Compact Cassette		
	AUXG18KVLA	AUXG22KVLA	AUXG24KVLA
Power Source	Single phase, ~230 V, 50 Hz		
Airflow Rate	Cooling H/M/L/Q Heating H/M/L/Q	680/580/490/410 800/680/580/450	830/740/600/450 860/760/700/530
Net Dimensions H x W x D	mm	245 x 570 x 570	245 x 570 x 570
Weight	kg	15	16
Cassette Grille		UTG-UFGF-W	UTG-UFGF-W

Indoor Units Model name	Duct		
	ARXG18KLLAP	ARXG22KMLB	ARXG24KMLA
Power Source	Single phase, ~230 V, 50 Hz		
Airflow Rate	Cooling H/M/L/Q Heating H/M/L/Q	940/880/820/750 1,100/910/750/580	1,100/910/750/580 1,100/910/750/580
Net Dimensions H x W x D	mm	198 x 900 x 620	270 x 1,135 x 700
Weight	kg	20	35

Outdoor Units Model name	AOHG36KBTB			AOHG45KBTB			AOHG54KBTB			
	AOHG36KRTA	AOHG45KRTA	AOHG54KRTA							
Capacity	Cooling	9.5	12.1	13.4	9.5	12.1	13.4	9.5	12.1	13.4
	Heating	10.8	13.5	15.5	10.8	13.5	15.5	10.8	13.5	15.5
Power Source	Single phase, ~230 V, 50 Hz						3-phase, ~400 V, 50 Hz			
Pdesign	Cooling	9.5	-	-	9.5	-	-	9.5	-	-
	Heating (-10°C)	8.7	-	-	8.7	-	-	8.7	-	-
SEER	Cooling	6.10	-	-	6.10	-	-	6.10	-	-
SCOP	Heating	4.00	-	-	4.00	-	-	4.00	-	-
Annual Energy Consumption	Cooling	545	-	-	545	-	-	545	-	-
	Heating	3,044	-	-	3,044	-	-	3,044	-	-
Energy Efficiency Class	Cooling	A++	-	-	A++	-	-	A++	-	-
	Heating	A+	-	-	A+	-	-	A+	-	-
Sound Pressure Level (High)	Cooling	55	57	57	55	57	57	55	57	57
	Heating	55	57	59	55	57	59	55	57	59
Sound Power Level (High)	Cooling	70	71	73	70	71	73	70	71	73
	Heating	70	71	73	70	71	73	70	71	73
Airflow Rate	Cooling/Heating	3,750/3,750	4,450/4,450	4,450/4,450	3,750/3,750	4,450/4,450	4,450/4,450	3,750/3,750	4,450/4,450	4,450/4,450
Net Dimensions H x W x D		788 x 940 x 320	998 x 940 x 320	998 x 940 x 320	788 x 940 x 320	998 x 940 x 320	998 x 940 x 320	788 x 940 x 320	998 x 940 x 320	998 x 940 x 320
Weight		52	67	67	53	67	67	53	67	67
Connection Pipe Diameter (Liquid/Gas)		9.52/15.88	9.52/15.88	9.52/15.88	9.52/15.88	9.52/15.88	9.52/15.88	9.52/15.88	9.52/15.88	9.52/15.88
Max. Pipe Length (Pre-Charge)		50 (30)	50 (30)	50 (30)	50 (30)	50 (30)	50 (30)	50 (30)	50 (30)	50 (30)
Max. Height Difference		30	30	30	30	30	30	30	30	30
Operating Range	Cooling	-15 to 46	-15 to 46	-15 to 46	-15 to 46	-15 to 46	-15 to 46	-15 to 46	-15 to 46	-15 to 46
	Heating	-15 to 24	-15 to 24	-15 to 24	-15 to 24	-15 to 24	-15 to 24	-15 to 24	-15 to 24	-15 to 24
Refrigerant	Type (Global Warming Potential)	R32 (675)	R32 (675)	R32 (675)	R32 (675)	R32 (675)	R32 (675)	R32 (675)	R32 (675)	R32 (675)
	Charge	1.90 (1.283)	2.70 (1.823)	2.70 (1.823)	1.90 (1.283)	2.70 (1.823)	2.70 (1.823)	1.90 (1.283)	2.70 (1.823)	2.70 (1.823)
Separation tube		UTP-SX236A (Twin)	UTP-SX236A (Twin)	UTP-SX236A (Twin) UTP-SX354A (Triple)	UTP-SX236A (Twin)	UTP-SX236A (Twin)	UTP-SX236A (Twin)	UTP-SX236A (Twin)	UTP-SX236A (Twin)	UTP-SX236A (Twin) UTP-SX354A (Triple)

• Indoor units of different types and capacity cannot be connected.
 • The above specifications apply when used with a cassette type indoor unit.

Dimensions

(Unit: mm)

AOHG36KBTB / AOHG36KRTA

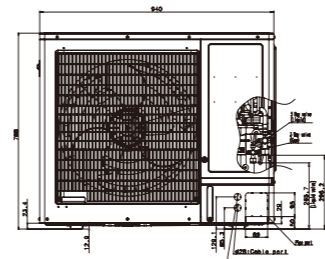
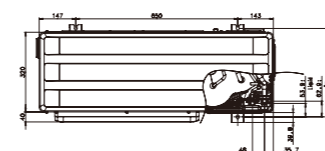

AOHG45KBTB / AOHG54KBTB AOHG45KRTA / AOHG54KRTA

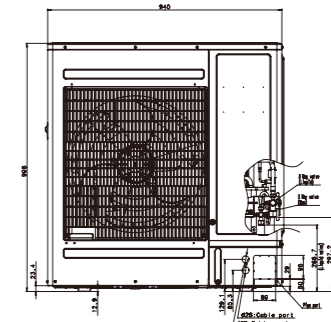
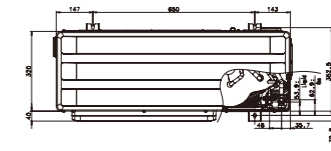

Simultaneous Multi-split Type

Twin / Triple / Double Twin



Meets a variety of installation needs from an open-plan office to a retail store, with up to 4 indoor units connected to an outdoor unit.

Select indoor units according to floor layout and heat load estimated by the number of people working in the room and the direction and intensity of sunlight entering the room. Perfect airflow distribution can be achieved for optimum comfort.

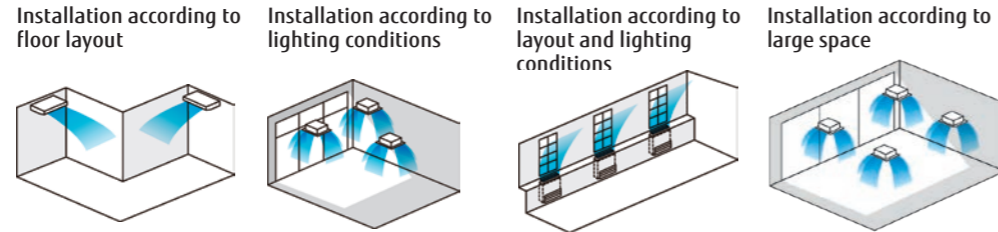

Simultaneous control

Up to 16 indoor units can be controlled simultaneously with a wired remote controller.

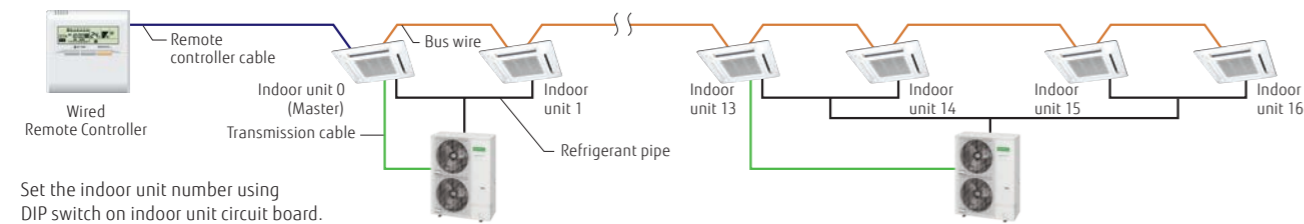

Set the indoor unit number using DIP switch on indoor unit circuit board.

*The following functions are not provided by a wireless remote controller: Timer operation, Sleep Timer operation, 10°C Heat operation

Indoor unit lineup

The indoor units, available in 18 models of 6 types, can be selected according to room size and conditions.

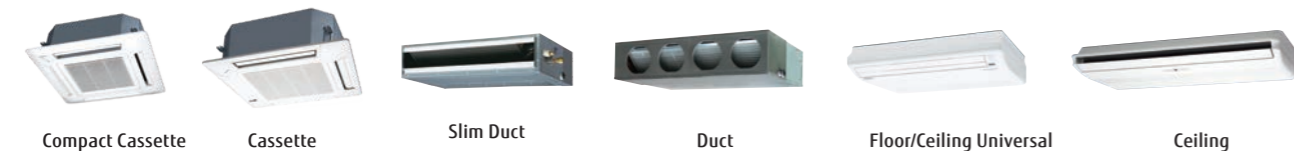

Model: AOHG72LRLA [3-phase] / AOHG90LRLA [3-phase]



Specifications (Indoor units/Outdoor units)

Indoor Units Model name		Compact Cassette, Cassette							
		AUHG18LVLB	AUHG22LVLA	AUHG24LVLA	AUHG30LRLE	AUHG36LRLE	AUHG45LRLA		
Power Source		Single phase, ~230 V, 50 Hz							
Airflow Rate	Cooling	H/M/L/Q	m ³ /h	750/610/520/410	930/830/600/450	930/830/600/450	1,600/1,400/1,270/1,150	1,800/1,400/1,270/1,150	1,900/1,640/1,460/1,250
	Heating	H/M/L/Q	m ³ /h	800/710/600/450	930/860/700/530	930/830/600/450	1,800/1,400/1,270/1,150	1,800/1,400/1,270/1,150	1,900/1,640/1,460/1,250
Net Dimensions H × W × D		mm		245 × 570 × 570	245 × 570 × 570	245 × 570 × 570	288 × 840 × 840	288 × 840 × 840	288 × 840 × 840
Weight		kg		15	16	16	26	26	26
Cassette Grille				UTG-UFGD-W			UTG-UGGA-W		

Indoor Units Model name		Duct							
		ARHG18LLTB	ARHG22LMLA	ARHG24LMLA	ARHG30LMLE	ARHG36LMLE	ARHG45LMLA		
Power Source		Single phase, ~230 V, 50 Hz							
Airflow Rate	Cooling	H/M/L/Q	m ³ /h	940/880/820/750	1,100/910/750/580	1,100/910/750/580	1,900/1,620/1,270/980	1,900/1,620/1,270/980	2,100/1,750/1,350/1,070
	Heating	H/M/L/Q	m ³ /h	940/880/820/750	1,100/910/750/580	1,100/910/750/580	2,100/1,620/1,270/980	2,100/1,620/1,270/980	2,100/1,750/1,350/1,070
Net Dimensions H × W × D		mm		198 × 900 × 620	270 × 1135 × 700	270 × 1135 × 700	270 × 1135 × 700	270 × 1135 × 700	270 × 1135 × 700
Weight		kg		23	38	40	40	40	40 (88)

Indoor Units Model name		Floor/Ceiling, Ceiling							
		ABHG18LVTB	ABHG22LVTA	ABHG24LVTA	ABHG30LRTE	ABHG36LRTE	ABHG45LRTA		
Power Source		Single phase, ~230 V, 50 Hz							
Airflow Rate	Cooling	H/M/L/Q	m ³ /h	780/700/560/500	980/820/680/540	980/820/680/540	1,660/1,500/1,200/1,000	1,900/1,500/1,200/1,000	2,100/1,700/1,400/1,100
	Heating	H/M/L/Q	m ³ /h	780/700/560/500	980/820/680/540	980/820/680/540	1,660/1,500/1,200/1,000	1,900/1,500/1,200/1,000	2,100/1,700/1,400/1,100
Net Dimensions H × W × D		mm		199 × 990 × 655	199 × 990 × 655	199 × 990 × 655	240 × 1660 × 700	240 × 1660 × 700	240 × 1660 × 700
Weight		kg		27	27	27	46	46	46

Outdoor Units Model name				AOHG72LRLA		AOHG90LRLA	
		Capacity	Cooling/Heating	kW	19.0	22.0	27.0
Power Source		3-phase, ~400 V, 50 Hz					
Sound Pressure Level (High)	Cooling/Heating	dB(A)		55/55		55/57	
Airflow Rate	Cooling/Heating	m ³ /h		8,400/8,400		8,400/9,000	
Net Dimensions H × W × D		mm		1,428 × 1,080 × 480		1,428 × 1,080 × 480	
Weight		kg		163		172	
Connection Pipe Diameter (Liquid/Gas)		mm		12.7/25.4		12.7/25.4	
Max. Pipe Length (Pre-Charge)		m		100 (30)		100 (30)	
Max. Height Difference		m		30		30	
Operating Range	Cooling	°CDB		-15 to 46		-15 to 46	
	Heating	°CDB		-20 to 24		-20 to 24	
Refrigerant	Type (Global Warming Potential)			R410A (2,088)		R410A (2,088)	
	Charge	kg (CO2eq-T)		5.6 (11.693)		7.1 (14.825)	
Separation tube				UTP-SX272A × 1 (Twin)	UTP-SX372A × 1 (Triple)	UTP-SX272A × 1 (Twin) UTP-SX236A × 2 (Double Twin)	UTP-SX272A × 1 (Twin) UTP-SX372A × 1 (Triple) UTP-SX254A × 2 (Double Twin)

*: That specification is not fixed yet.

• Indoor units of different types and capacity cannot be connected.
• The above specifications apply when used with a cassette type indoor unit.

Dimensions

(Unit: mm)

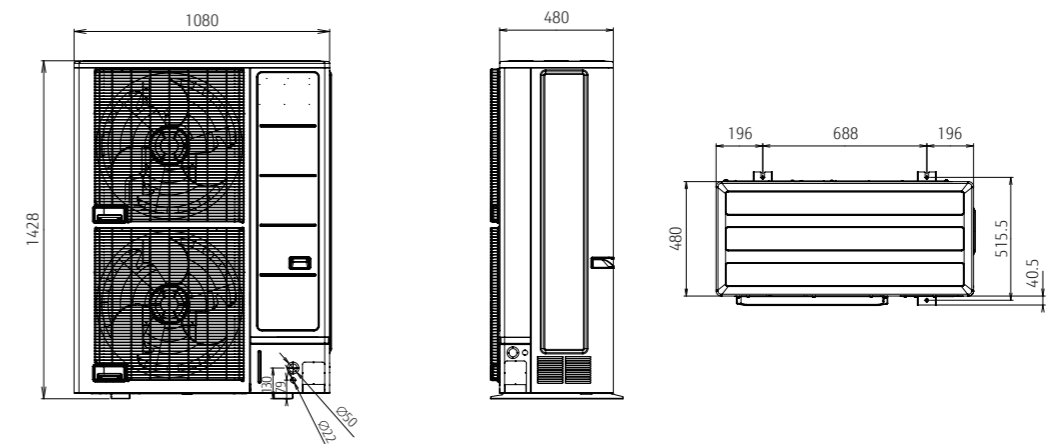

2-unit to 5-unit Multi-split Indoor Units Specifications



Wall-mounted type

Model name	Indoor unit		ASHH07KGTG ASHG07KGTG	ASHH09KGTG ASHG09KGTG	ASHH12KGTG ASHG12KGTG	ASHH14KGTG ASHG14KGTG	
kW Class	kW		2.0	2.5	3.5	4.0	
Power Source	Single phase, ~230 V, 50 Hz						
Sound Pressure Level	Cooling	H/M/L/Q	dB(A)	38/33/29/21	40/34/29/21	40/35/30/21	43/36/30/21
	Heating			41/35/31/22	42/36/31/22	42/38/33/22	44/39/33/24
Sound Power Level	Cooling	H	dB(A)	54	55	56	57
	Heating			56	57	58	59
Airflow Rate	Cooling	H/M/L/Q	m³/h	650/540/430/270	700/560/430/270	700/560/430/270	770/600/450/280
	Heating			720/580/460/330	750/610/470/330	770/640/520/330	800/660/520/340
Net Dimensions	mm		270 × 834 × 215	270 × 834 × 215	270 × 834 × 215	270 × 834 × 215	
Weight	kg		10	10	10	10	
Connection Pipe Diameter	Liquid/Gas	mm	6.35/9.52	6.35/9.52	6.35/9.52	6.35/9.52	



Wall-mounted type

Model name	Indoor unit		ASHH05KNCA	ASHH07KNCA	ASHH09KNCA	ASHH12KNCA	
kW Class	kW		1.5	2.0	2.5	3.5	
Power Source	Single phase, ~230 V, 50 Hz						
Sound Pressure Level	Cooling	H/M/L/Q	dB(A)	34 / 33 / 29 / 21	36 / 33 / 29 / 21	41 / 35 / 29 / 21	42 / 36 / 32 / 21
	Heating			34 / 32 / 30 / 22	36 / 33 / 30 / 22	41 / 34 / 30 / 22	42 / 35 / 31 / 22
Sound Power Level	Cooling	H	dB(A)	50	51	56	57
	Heating			50	51	56	57
Airflow Rate	Cooling	H/M/L/Q	m³/h	500 / 450 / 390 / 250	530 / 460 / 390 / 250	640 / 500 / 390 / 250	660 / 520 / 440 / 250
	Heating			500 / 450 / 420 / 280	530 / 460 / 420 / 280	640 / 500 / 420 / 280	660 / 520 / 440 / 280
Net Dimensions	mm		270 × 784 × 222	270 × 784 × 222	270 × 784 × 222	270 × 784 × 222	
Weight	kg		9	9	9	9	
Connection Pipe Diameter	Liquid/Gas	mm	6.35 / 9.52	6.35 / 9.52	6.35 / 9.52	6.35 / 9.52	



Wall-mounted type

Model name	Indoor unit		ASHG07KETF ASHG07KETF-B ASHG07KETE ASHG07KETE-B	ASHG09KETF ASHG09KETF-B ASHG09KETE ASHG09KETE-B	ASHG12KETF ASHG12KETF-B ASHG12KETE ASHG12KETE-B	ASHG14KETF ASHG14KETF-B ASHG14KETE ASHG14KETE-B	
kW Class	kW		2.0	2.5	3.5	4.0	
Power Source	Single phase, ~230 V, 50 Hz						
Sound Pressure Level	Cooling	H/M/L/Q	dB(A)	38/33/29/21	40/34/29/21	40/35/30/21	43/36/30/21
	Heating			41/35/31/22	42/36/31/22	42/38/33/22	44/39/33/24
Sound Power Level	Cooling	H	dB(A)	54	55	55	57
	Heating			56	57	58	59
Airflow Rate	Cooling	H/M/L/Q	m³/h	650/540/430/270	700/560/430/270	700/560/430/270	770/600/450/280
	Heating			720/580/460/330	750/610/470/330	770/640/520/330	800/660/520/340
Net Dimensions	mm		295 × 950 (wall side: 840) × 230	295 × 950 (wall side: 840) × 230	295 × 950 (wall side: 840) × 230	295 × 950 (wall side: 840) × 230	
Weight	kg		11	11	11	11.5	
Connection Pipe Diameter	Liquid/Gas	mm	6.35/9.52	6.35/9.52	6.35/9.52	6.35/9.52	



Wall-mounted type

Model name	Indoor unit		ASHG18KMTE	ASHG22KMTE	ASHG24KMTE	
kW Class	kW		5.0	6.0	7.0	
Power Source	Single phase, ~230 V, 50 Hz					
Sound Pressure Level	Cooling	H/M/L/Q	dB(A)	45/40/35/29	48/40/35/29	49/40/35/29
	Heating			46/40/35/29	48/40/35/29	49/40/35/29
Sound Power Level	Cooling	H	dB(A)	60	62	65
	Heating			61	62	65
Airflow Rate	Cooling	H/M/L/Q	m³/h	980/810/640/510	1,060/810/640/510	1,170/850/640/510
	Heating			1,020/850/640/510	1,060/850/640/510	1,170/850/640/510
Net Dimensions	mm		280 × 980 × 240	280 × 980 × 240	280 × 980 × 240	
Weight	kg		12.5	12.5	12.5	
Connection Pipe Diameter	Liquid/Gas	mm	6.35/12.70	6.35/12.70	6.35/12.70	



Wall-mounted type

Model name	Indoor unit		ASHH07KMCG ASHG07KMCE	ASHH09KMCG ASHG09KMCE	ASHH12KMCG ASHG12KMCE	ASHH14KMCG ASHG14KMCE	
kW Class	kW		2.0	2.5	3.5	4.0	
Power Source	Single phase, ~230 V, 50 Hz						
Sound Pressure Level	Cooling	H/M/L/Q	dB(A)	38/33/29/21	40/34/29/21	40/35/30/21	43/36/30/21
	Heating			41/35/31/22	42/36/31/22	42/38/33/22	44/39/33/24
Sound Power Level	Cooling	H	dB(A)	54	55	55	57
	Heating			56	57	58	59
Airflow Rate	Cooling	H/M/L/Q	m³/h	650/540/430/320	700/560/430/320	700/560/430/320	770/600/450/310
	Heating			720/580/460/330	750/610/470/330	780/640/520/330	820/660/520/340
Net Dimensions	mm		270 × 834 × 215	270 × 834 × 215	270 × 834 × 215	270 × 834 × 215	
Weight	kg		10	10	10	10	
Connection Pipe Diameter	Liquid/Gas	mm	6.35/9.52	6.35/9.52	6.35/9.52	6.35/9.52	



Floor

Model name	Indoor unit		AGHG09KVCA	AGHG12KVCA	AGHG14KVCA	
kW Class	kW		2.5	3.5	4.0	
Power Source	Single phase, ~230 V, 50 Hz					
Sound Pressure Level	Cooling	H/M/L/Q	dB(A)	39/34/28/22	42/36/30/22	44/38/31/22
	Heating			39/35/30/22	42/38/32/22	44/39/33/22
Sound Power Level	Cooling	H	dB(A)	52	55	56
	Heating			52	55	56
Airflow Rate	Cooling	H/M/L/Q	m³/h	530/440/360/270	600/490/380/270	650/520/400/270
	Heating			530/460/380/270	600/510/410/270	650/540/430/270
Net Dimensions	mm		600 × 740 × 200	600 × 740 × 200	600 × 740 × 200	
Weight	kg		14	14	14	
Connection Pipe Diameter	Liquid/Gas	mm	6.35/9.52	6.35/9.52	6.35/9.52	



2-unit to 5-unit Multi-split Indoor Units Specifications

Ceiling



Model name	Indoor unit		ABHG18KRTA		ABHG22KRTA		
kW Class	kW		5.0		6.0		
Power Source	Single phase, ~230 V, 50 Hz						
Sound Pressure Level	Cooling	H/M/L/Q	dB(A)	38/36/33/31		42/37/34/31	
	Heating			38/36/33/31		42/37/34/31	
Sound Power Level	Cooling	H	dB(A)	53		57	
	Heating			53		57	
Airflow Rate	Cooling	H/M/L/Q	m³/h	840/790/710/650		900/790/710/650	
	Heating			840/790/710/650		900/790/710/650	
Net Dimensions	mm		235 × 1,080 × 705		235 × 1,080 × 705		
Weight	kg		24		24		
Connection Pipe Diameter	Liquid/Gas	mm		6.35/12.70		6.35/12.70	

Compact Cassette Grid Type



Model name	Indoor unit		AUXG07KVLA	AUXG09KVLA	AUXG12KVLA	AUXG14KVLA	AUXG18KVLA	AUXG22KVLA	
kW Class	kW		2.0	2.5	3.5	4.0	5.0	6.0	
Power Source	Single phase, ~230 V, 50 Hz								
Sound Pressure Level	Cooling	H/M/L/Q	dB(A)	33/31/29/27		37/34/31/28		38/35/32/29	
	Heating			34/32/29/27		43/38/34/30		45/43/40/33	
Sound Power Level	Cooling	H	dB(A)	46		49		50	
	Heating			47		55		57	
Airflow Rate	Cooling	H/M/L/Q	m³/h	540/490/440/390		610/530/470/410		680/580/490/410	
	Heating			540/490/440/390		790/680/580/450		860/760/700/530	
Net Dimensions	mm		245 × 570 × 570		245 × 570 × 570		245 × 570 × 570		
Weight	kg		15		15		16		
Panel			UTG-UFGF-W		UTG-UFGF-W		UTG-UFGF-W		
Connection Pipe Diameter	Liquid/Gas	mm		6.35/9.52		6.35/9.52		6.35/12.70	

Mini duct



Model name	Indoor unit		ARXG07KSLAP	ARXG09KSLAP	ARXG12KSLAP	ARXG14KSLAP	ARXG18KSLAP		
kW Class	kW		2.0	2.5	3.5	4.0	5.0		
Power Source	Single phase, ~230 V, 50 Hz								
Sound Pressure Level	Cooling	H/M/L/Q	dB(A)	29/26/24/23		31/27/25/23		35/30/27/23	
	Heating			29/26/24/23		31/27/25/23		33/29/26/23	
Sound Power Level	Cooling	H	dB(A)	52		55		60	
	Heating			53		62		59	
Airflow Rate	Cooling	H/M/L/Q	m³/h	550/440/390/360		650/490/430/360		800/640/530/360	
	Heating			550/440/390/360		650/490/430/360		940/750/540/480	
Net Dimensions	mm		198 × 700 × 450		198 × 700 × 450		198 × 700 × 450		
Weight	kg		15.5		15.5		18.5		
Connection Pipe Diameter	Liquid/Gas	mm		6.35/9.52		6.35/9.52		6.35/12.70	
External static pressure	Pa		0 to 30		0 to 30		0 to 50		
Drain pump			Standard		Standard		Standard		

Slim duct



Model name	Indoor unit		ARXG07KLLAP	ARXG09KLLAP	ARXG12KLLAP	ARXG14KLLAP	ARXG18KLLAP		
kW Class	kW		2.0	2.5	3.5	4.0	5.0		
Power Source	Single phase, ~230 V, 50 Hz								
Sound Pressure Level	Cooling	H/M/L/Q	dB(A)	28/27/26/25		29/28/27/26		32/30/28/26	
	Heating			28/26/25/24		29/28/27/24		32/30/28/25	
Sound Power Level	Cooling	H	dB(A)	57		58		60	
	Heating			57		58		58	
Airflow Rate	Cooling	H/M/L/Q	m³/h	550/490/470/440		650/600/550/480		800/700/600/480	
	Heating			550/490/470/440		650/600/550/480		940/880/820/750	
Net Dimensions	mm		198 × 700 × 620		198 × 700 × 620		198 × 700 × 620		
Weight	kg		16		17		20		
Connection Pipe Diameter	Liquid/Gas	mm		6.35/9.52		6.35/9.52		6.35/12.70	
External static pressure	Pa		0 to 90		0 to 90		0 to 90		
Drain pump			Standard		Standard		Standard		

Medium Static Pressure Duct

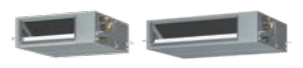

Model name	Indoor unit		ARXH12KMTAP	ARXH14KMTAP	ARXH18KMTAP	ARXH22KMTAP	
kW Class	kW		3.5	4.0	5.0	6.0	
Power Source	Single-phase, ~230V, 50Hz						
Sound Pressure Level	Cooling	H/M/L/Q	dB(A)	29 / 27 / 25 / 23		32 / 29 / 27 / 25	
	Heating			29 / 27 / 25 / 23		33 / 30 / 28 / 26	
Sound Power Level	Cooling	H	dB(A)	58		59	
	Heating			58		60	
Airflow Rate	Cooling	H/M/L/Q	m³/h	650 / 520 / 460 / 390		800 / 640 / 560 / 480	
	Heating			650 / 520 / 460 / 390		840 / 720 / 630 / 540	
Net Dimensions	mm		240 × 700 × 700		240 × 700 × 700		
Weight	kg		24		24		
Connection Pipe Diameter	Liquid/Gas	mm		6.35 / 9.52		6.35 / 12.7	
External static pressure	Pa		30 to 150		30 to 150		
Drain pump			Standard		Standard		

Medium Static Pressure Duct



Model name	Indoor unit		ARXG22KMLB		
kW Class	kW		6.0		
Power Source	Single phase, ~230 V, 50 Hz				
Sound Pressure Level	Cooling	H/M/L/Q	dB(A)	31/29/27/25	
	Heating			31/29/27/25	
Sound Power Level	Cooling	H	dB(A)	60	
	Heating			62	
Airflow Rate	Cooling	H/M/L/Q	m³/h	1,100/910/750/580	
	Heating			1,100/910/750/580	
Net Dimensions	mm		270 × 1,135 × 700		
Weight	kg		35		
Connection Pipe Diameter	Liquid/Gas	mm		6.35/12.70	
External static pressure	Pa		30 to 150		
Drain pump			Option		

6-unit Multi-split Indoor Units Specifications

Compact wall-mounted



Model name	Indoor unit			ASHG07LUCA	ASHG09LUCA	ASHG12LUCA	ASHG14LUCA
kW Class	kW			2.0	2.5	3.5	4.0
Power Source	Single phase, ~230 V, 50 Hz						
Sound Pressure Level	Cooling	H/M/L/Q	dB(A)	35/30/28/21	36/32/28/21	37/34/31/21	41/36/33/25
	Heating			35/30/28/21	36/32/28/21	37/34/31/21	41/36/34/27
Sound Power Level	Cooling	H	dB(A)	53	54	55	59
	Heating			53	54	55	59
Airflow Rate	Cooling	H/M/L/Q	m³/h	570/520/470/330	600/550/470/330	660/600/530/330	710/640/570/390
	Heating			570/520/470/330	600/550/470/330	660/600/530/330	710/640/590/430
Net Dimensions	mm			282 × 870 × 185	282 × 870 × 185	282 × 870 × 185	282 × 870 × 185
Weight	kg			9.5	9.5	9.5	9.5
Connection Pipe Diameter	Liquid/Gas	mm		6.35/9.52	6.35/9.52	6.35/9.52	6.35/12.70

Wall-mounted type



Model name	Indoor unit			ASHG18LFCA	ASHG24LFCC
kW Class	kW			5.0	7.0
Power Source	Single phase, ~230 V, 50 Hz				
Sound Pressure Level	Cooling	H/M/L/Q	dB(A)	43/37/33/26	49/42/37/33
	Heating			42/37/33/25	48/42/37/33
Sound Power Level	Cooling	H	dB(A)	58	64
	Heating			58	64
Airflow Rate	Cooling	H/M/L/Q	m³/h	900/740/620/550	1,120/900/740/620
	Heating			900/740/620/550	1,100/900/740/620
Net Dimensions	mm			320 × 998 × 238	320 × 998 × 238
Weight	kg			14	14
Connection Pipe Diameter	Liquid/Gas	mm		6.35/12.70	6.35/15.88

Compact wall-mounted



Model name	Indoor unit			ASHG07LMCA	ASHG09LMCA	ASHG12LMCA	ASHG14LMCA
kW Class	kW			2.0	2.5	3.5	4.0
Power Source	Single phase, ~230 V, 50 Hz						
Sound Pressure Level	Cooling	H/M/L/Q	dB(A)	36/32/29/21	37/33/29/21	40/36/30/21	42/38/33/25
	Heating			36/32/29/22	37/33/29/22	40/36/31/22	42/38/35/27
Sound Power Level	Cooling	H	dB(A)	51	52	54	56
	Heating			51	52	55	57
Airflow Rate	Cooling	H/M/L/Q	m³/h	560/500/430/310	600/520/430/310	660/560/450/310	730/600/530/360
	Heating			560/500/430/330	600/520/430/330	660/560/470/330	730/615/560/375
Net Dimensions	mm			268 × 840 × 203	268 × 840 × 203	268 × 840 × 203	268 × 840 × 203
Weight	kg			8.5	8.5	8.5	8.5
Connection Pipe Diameter	Liquid/Gas	mm		6.35/9.52	6.35/9.52	6.35/9.52	6.35/12.70

Floor



Model name	Indoor unit			AGHG09LVCA	AGHG12LVCA	AGHG14LVCA
kW Class	kW			2.5	3.5	4.0
Power Source	Single phase, ~230 V, 50 Hz					
Sound Pressure Level	Cooling	H/M/L/Q	dB(A)	39/34/28/22	42/36/30/22	44/38/31/22
	Heating			39/35/30/22	42/38/32/22	44/39/33/22
Sound Power Level	Cooling	H	dB(A)	52	55	56
	Heating			52	55	56
Airflow Rate	Cooling	H/M/L/Q	m³/h	530/440/360/270	600/490/380/270	650/520/400/270
	Heating			530/460/380/270	600/510/410/270	650/540/430/270
Net Dimensions	mm			600 × 740 × 200	600 × 740 × 200	600 × 740 × 200
Weight	kg			14	14	14
Connection Pipe Diameter	Liquid/Gas	mm		6.35/9.52	6.35/9.52	6.35/12.70

Floor ceiling



Model name	Indoor unit			ABHG14LVTA	ABHG18LVTB
kW Class	kW			4.0	5.0
Power Source	Single phase, ~230 V, 50 Hz				
Sound Pressure Level	Cooling	H/M/L/Q	dB(A)	36/34/33/29 (Under ceiling) 39/37/36/32 (Floor console)	41/38/34/32 (Under ceiling) 44/41/37/35 (Floor console)
	Heating			36/34/33/29 (Under ceiling) 39/37/36/32 (Floor console)	41/38/34/32 (Under ceiling) 44/41/37/35 (Floor console)
Sound Power Level	Cooling	H	dB(A)	51	55
	Heating			51	55
Airflow Rate	Cooling	H/M/L/Q	m³/h	640/590/540/480	780/700/560/500
	Heating			640/590/540/480	780/700/560/500
Net Dimensions	mm			199 × 990 × 655	199 × 990 × 655
Weight	kg			27	27
Connection Pipe Diameter	Liquid/Gas	mm		6.35/12.70	6.35/12.70

Compact cassette



Model name	Indoor unit			AUHG07LVLA	AUHG09LVLA	AUHG12LVLB	AUHG14LVLB	AUHG18LVLB
kW Class	kW			2.0	2.5	3.5	4.0	5.0
Power Source	Single phase, ~230 V, 50 Hz							
Sound Pressure Level	Cooling	H/M/L/Q	dB(A)	33/31/29/27	33/31/29/27	37/33/31/28	40/35/32/29	42/37/33/29
	Heating			34/32/29/27	34/32/29/27	37/33/31/28	40/37/34/29	44/40/37/30
Sound Power Level	Cooling	H	dB(A)	46	46	49	52	54
	Heating			47	47	49	52	56
Airflow Rate	Cooling	H/M/L/Q	m³/h	540/490/440/390	540/490/440/390	610/530/470/410	680/580/490/410	750/610/520/410
	Heating			540/490/440/390	540/490/440/390	610/530/470/410	700/620/550/430	800/710/600/450
Net Dimensions	mm			245 × 570 × 570	245 × 570 × 570	245 × 570 × 570	245 × 570 × 570	245 × 570 × 570
Weight	kg			15	15	15	15	15
Panel				UTG-UFGD-W				
Connection Pipe Diameter	Liquid/Gas	mm		6.35/9.52	6.35/9.52	6.35/9.52	6.35/12.70	6.35/12.70

Mini duct

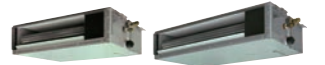

Model name	Indoor unit			ARRHG07LSLAP	ARRHG09LSLAP	ARRHG12LSLAP	ARRHG14LSLAP	ARRHG18LSLAP
kW Class	kW			2.0	2.5	3.5	4.0	5.0
Power Source	Single phase, ~230 V, 50 Hz							
Sound Pressure Level	Cooling	H/M/L/Q	dB(A)	29/26/24/23	29/26/24/23	31/27/25/23	35/30/27/23	33/29/26/23
	Heating			29/26/24/23	29/26/24/23	31/27/25/23	35/30/27/23	33/29/26/23
Sound Power Level	Cooling	H	dB(A)	52	54	55	60	58
	Heating			53	56	57	62	59
Airflow Rate	Cooling	H/M/L/Q	m³/h	550/440/390/360	600/450/400/360	650/490/430/360	800/640/530/360	940/750/540/480
	Heating			550/440/390/360	600/450/400/360	650/490/430/360	800/640/530/360	940/750/540/480
Net Dimensions	mm			198 × 700 × 450	198 × 700 × 450	198 × 700 × 450	198 × 700 × 450	198 × 900 × 450
Weight	kg			15.5				
Connection Pipe Diameter	Liquid/Gas	mm		6.35/9.52			6.35/12.70	
External static pressure	Pa			0 to 30			0 to 50	
Drain pump	Standard							

Slim duct

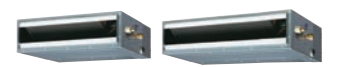

Model name	Indoor unit			ARRHG07LLTA	ARRHG09LLTA	ARRHG12LLTB	ARRHG14LLTB	ARRHG18LLTB
kW Class	kW			2.0	2.5	3.5	4.0	5.0
Power Source	Single phase, ~230 V, 50 Hz							
Sound Pressure Level	Cooling	H/M/L/Q	dB(A)	28/26/25/24	28/27/26/25	29/28/27/26	32/30/28/26	32/31/30/29
	Heating			28/26/25/24	28/26/25/24	29/28/27/24	33/30/28/25	33/32/31/29
Sound Power Level	Cooling	H	dB(A)	57	57	58	60	58
	Heating			57	57	58	61	59
Airflow Rate	Cooling	H/M/L/Q	m³/h	550/490/470/440	600/550/500/450	650/600/550/480	800/700/600/480	940/880/820/750
	Heating			550/490/470/440	600/550/500/450	650/600/550/480	800/700/600/480	940/880/820/750
Net Dimensions	mm			198 × 700 × 620	198 × 700 × 620	198 × 700 × 620	198 × 700 × 620	198 × 900 × 620
Weight	kg			17	19	19	19	23
Connection Pipe Diameter	Liquid/Gas	mm		6.35/9.52	6.35/9.52	6.35/9.52	6.35/12.7	6.35/12.70
External static pressure	Pa			0 to 90				
Drain pump	Standard							

2-unit Multi-split Combination Table-Cooling/Heating

2-unit Multi-split cooling

AOHG14KBTA2	Combination of Indoor Units		Cooling Operation				Seasonal Data			
			Cooling Capacity			Input Power (Min. - Max.) kW	EER	Pdesign kW	SEER	Energy efficiency class
			Unit 1 kW	Unit 2 kW	Total Capacity (Min. - Max.) kW					
2-unit connection	7	7	2.00	2.00	4.00 (1.4-4.6)	0.97 (0.25-1.20)	4.12	4.0	8.7	A+++
	7	9	1.75	2.25	4.00 (1.4-4.6)	0.97 (0.25-1.20)	4.12	4.0	8.7	A+++
	7	12	1.47	2.53	4.00 (1.4-4.6)	0.97 (0.25-1.20)	4.12	4.0	8.7	A+++
	9	9	2.00	2.00	4.00 (1.4-4.6)	0.97 (0.25-1.20)	4.12	4.0	8.7	A+++
	9	12	1.71	2.29	4.00 (1.4-4.6)	0.97 (0.25-1.20)	4.12	4.0	8.7	A+++

Notes: •7: 7000 Btu/h/9: 9000 Btu/h/12: 12000 Btu/h models
 •The above specifications apply when connected with a wall-mounted [KG/KM] unit.
 •2 or more indoor units should be connected.
 •Cooling capacity is determined based on 27°CDB/19°CWB (indoor temperature) and 35°CDB (outdoor temperature).
 •Pipe Length: 5 m, Height difference: 0 m (Outdoor unit to Indoor unit)
 •Total capacity of indoor units connected must be between 4.0 kW and 6.0 kW.
 •Please refer to the Design & Technical manual for the combination tables with 5kW model.

AOHG18KBTA2	Combination of Indoor Units		Cooling Operation				Seasonal Data			
			Cooling Capacity			Input Power (Min. - Max.) kW	EER	Pdesign kW	SEER	Energy efficiency class
			Unit 1 kW	Unit 2 kW	Total Capacity (Min. - Max.) kW					
2-unit connection	7	7	2.00	2.00	4.00 (1.7-5.0)	0.92 (0.25-1.23)	4.35	4.0	8.8	A+++
	7	9	2.00	2.50	4.50 (1.7-5.7)	1.07 (0.25-1.45)	4.22	4.5	8.7	A+++
	7	12	1.84	3.16	5.00 (1.7-5.8)	1.24 (0.25-1.55)	4.03	5.0	8.6	A+++
	7	14	1.67	3.33	5.00 (1.7-5.8)	1.24 (0.25-1.55)	4.03	5.0	8.6	A+++
	9	9	2.50	2.50	5.00 (1.7-5.8)	1.24 (0.25-1.55)	4.03	5.0	8.6	A+++
	9	12	2.14	2.86	5.00 (1.7-5.8)	1.24 (0.25-1.55)	4.03	5.0	8.6	A+++
	9	14	1.96	3.04	5.00 (1.7-5.8)	1.24 (0.25-1.55)	4.03	5.0	8.6	A+++
	12	12	2.50	2.50	5.00 (1.7-5.8)	1.24 (0.25-1.55)	4.03	5.0	8.6	A+++
	12	14	2.31	2.69	5.00 (1.7-5.8)	1.24 (0.25-1.55)	4.03	5.0	8.6	A+++

Notes: •7: 7000 Btu/h/9: 9000 Btu/h/12: 12000 Btu/h/14: 14000 Btu/h models
 •The above specifications apply when connected with a wall-mounted [KG/KM] unit.
 •2 or more indoor units should be connected.
 •Cooling capacity is determined based on 27°CDB/19°CWB (indoor temperature) and 35°CDB (outdoor temperature).
 •Pipe Length: 5 m, Height difference: 0 m (Outdoor unit to Indoor unit)
 •Total capacity of indoor units connected must be between 4.0 kW and 7.5 kW.
 •Please refer to the Design & Technical manual for the combination tables with 5kW model.

2-unit Multi-split heating

AOHG14KBTA2	Combination of Indoor Units		Heating Operation				Seasonal Data			
			Heating Capacity			Input Power (Min. - Max.) kW	COP	Pdesign kW	SCOP	Energy efficiency class
			Unit 1 kW	Unit 2 kW	Total Capacity (Min. - Max.) kW					
2-unit connection	7	7	2.20	2.20	4.40 (1.1-5.5)	0.95 (0.25-1.65)	4.63	3.5	4.7	A++
	7	9	1.92	2.48	4.40 (1.1-5.5)	0.95 (0.25-1.65)	4.63	3.5	4.7	A++
	7	12	1.62	2.78	4.40 (1.1-5.5)	0.95 (0.25-1.65)	4.63	3.5	4.7	A++
	9	9	2.20	2.20	4.40 (1.1-5.5)	0.95 (0.25-1.65)	4.63	3.5	4.7	A++
	9	12	1.89	2.51	4.40 (1.1-5.5)	0.95 (0.25-1.65)	4.63	3.5	4.7	A++

Notes: •7: 7000 Btu/h/9: 9000 Btu/h/12: 12000 Btu/h models
 •The above specifications apply when connected with a wall-mounted [KG/KM] unit.
 •2 or more indoor units should be connected.
 •Heating capacity is determined based on 20°CDB (indoor temperature) and 7°CDB/6°CWB (outdoor temperature).
 •Pipe Length: 5 m, Height difference: 0 m (Outdoor unit to Indoor unit)
 •Total capacity of indoor units connected must be between 4.0 kW and 6.0 kW.
 •Please refer to the Design & Technical manual for the combination tables with 5kW model.

AOHG18KBTA2	Combination of Indoor Units		Heating Operation				Seasonal Data			
			Heating Capacity			Input Power (Min. - Max.) kW	COP	Pdesign kW	SCOP	Energy efficiency class
			Unit 1 kW	Unit 2 kW	Total Capacity (Min. - Max.) kW					
2-unit connection	7	7	2.40	2.40	4.80 (1.7-5.6)	0.99 (0.25-1.35)	4.85	3.8	4.7	A++
	7	9	2.40	3.00	5.40 (1.7-6.4)	1.15 (0.25-1.60)	4.70	4.0	4.7	A++
	7	12	2.06	3.54	5.60 (1.7-7.0)	1.22 (0.25-1.80)	4.59	4.2	4.7	A++
	7	14	1.87	3.73	5.60 (1.7-7.0)	1.22 (0.25-1.80)	4.59	4.2	4.7	A++
	9	9	2.80	2.80	5.60 (1.7-7.0)	1.22 (0.25-1.80)	4.59	4.2	4.7	A++
	9	12	2.40	3.20	5.60 (1.7-7.0)	1.22 (0.25-1.80)	4.59	4.2	4.7	A++
	9	14	2.19	3.41	5.60 (1.7-7.0)	1.22 (0.25-1.80)	4.59	4.2	4.7	A++
	12	12	2.80	2.80	5.60 (1.7-7.0)	1.22 (0.25-1.80)	4.59	4.2	4.7	A++
	12	14	2.58	3.02	5.60 (1.7-7.0)	1.22 (0.25-1.80)	4.59	4.2	4.7	A++

Notes: •7: 7000 Btu/h/9: 9000 Btu/h/12: 12000 Btu/h/14: 14000 Btu/h models
 •The above specifications apply when connected with a wall-mounted [KG/KM] unit.
 •2 or more indoor units should be connected.
 •Heating capacity is determined based on 20°CDB (indoor temperature) and 7°CDB/6°CWB (outdoor temperature).
 •Pipe Length: 5 m, Height difference: 0 m (Outdoor unit to Indoor unit)
 •Total capacity of indoor units connected must be between 4.0 kW and 7.5 kW.
 •Please refer to the Design & Technical manual for the combination tables with 5kW model.

3-unit Multi-split Combination Table-Cooling/Heating

3-unit Multi-split cooling

AOHG18KBTA3	Combination of Indoor Units			Cooling Operation					Seasonal Data			
				Cooling Capacity			Input Power (Min. - Max.) kW	EER	Pdesign kW	SEER	Energy efficiency	
				Unit 1 kW	Unit 2 kW	Unit 3 kW						Total Capacity (Min. - Max.) kW
2-unit connection	7	7	-	2.00	2.00	-	4.00 (1.8-5.0)	0.86 (0.35-1.35)	4.65	4.0	8.3	A++
	7	9	-	2.00	2.50	-	4.50 (1.8-5.7)	1.03 (0.35-1.50)	4.36	4.5	8.2	A++
	7	12	-	1.99	3.41	-	5.40 (1.8-6.8)	1.41 (0.35-1.81)	3.83	5.4	8.0	A++
	7	14	-	1.80	3.60	-	5.40 (1.8-7.0)	1.41 (0.35-1.90)	3.83	5.4	8.0	A++
	9	9	-	2.50	2.50	-	5.00 (1.8-6.4)	1.23 (0.35-1.70)	4.06	5.0	8.1	A++
	9	12	-	2.31	3.09	-	5.40 (1.8-7.0)	1.41 (0.35-1.90)	3.83	5.4	8.0	A++
	9	14	-	2.11	3.29	-	5.40 (1.8-7.0)	1.41 (0.35-1.90)	3.83	5.4	8.0	A++
	12	12	-	2.70	2.70	-	5.40 (1.8-7.0)	1.41 (0.35-1.90)	3.83	5.4	8.0	A++
	12	14	-	2.49	2.91	-	5.40 (1.8-7.0)	1.41 (0.35-1.90)	3.83	5.4	8.0	A++
	14	14	-	2.70	2.70	-	5.40 (1.8-7.0)	1.41 (0.35-1.90)	3.83	5.4	8.0	A++
3-unit connection	7	7	7	1.80	1.80	1.80	5.40 (1.8-7.0)	1.13 (0.35-1.90)	4.78	5.4	8.6	A+++
	7	7	9	1.64	1.64	2.12	5.40 (1.8-7.0)	1.13 (0.35-1.90)	4.78	5.4	8.6	A+++
	7	7	12	1.45	1.45	2.50	5.40 (1.8-7.0)	1.13 (0.35-1.90)	4.78	5.4	8.6	A+++
	7	7	14	1.35	1.35	2.70	5.40 (1.8-7.0)	1.13 (0.35-1.90)	4.78	5.4	8.6	A+++
	7	9	9	1.52	1.94	1.94	5.40 (1.8-7.0)	1.13 (0.35-1.90)	4.78	5.4	8.6	A+++
	7	9	12	1.35	1.74	2.31	5.40 (1.8-7.0)	1.13 (0.35-1.90)	4.78	5.4	8.6	A+++
	7	9	14	1.26	1.62	2.52	5.40 (1.8-7.0)	1.13 (0.35-1.90)	4.78	5.4	8.6	A+++
	9	9	9	1.80	1.80	1.80	5.40 (1.8-7.0)	1.13 (0.35-1.90)	4.78	5.4	8.6	A+++
	9	9	12	1.62	1.62	2.16	5.40 (1.8-7.0)	1.13 (0.35-1.90)	4.78	5.4	8.6	A+++

AOHG24KBTA3	Combination of Indoor Units			Cooling Operation					Seasonal Data			
				Cooling Capacity			Input Power (Min. - Max.) kW	EER	Pdesign kW	SEER	Energy efficiency	
				Unit 1 kW	Unit 2 kW	Unit 3 kW						Total Capacity (Min. - Max.) kW
2-unit connection	7	7	-	2.00	2.00	-	4.00 (1.8-5.0)	0.86 (0.35-1.35)	4.65	4.0	8.3	A++
	7	9	-	2.00	2.50	-	4.50 (1.8-5.7)	1.03 (0.35-1.50)	4.36	4.5	8.2	A++
	7	12	-	2.00	3.50	-	5.50 (1.8-6.8)	1.46 (0.35-1.85)	3.77	5.5	8.0	A++
	7	14	-	2.00	4.00	-	6.00 (1.8-7.5)	1.73 (0.35-2.20)	3.48	6.0	7.6	A++
	7	18	-	1.90	4.90	-	6.80 (1.8-8.5)	2.26 (0.35-2.65)	3.01	6.8	6.9	A++
	9	9	-	2.50	2.50	-	5.00 (1.8-6.4)	1.23 (0.35-1.74)	4.06	5.0	8.1	A++
	9	12	-	2.50	3.50	-	6.00 (1.8-7.5)	1.73 (0.35-2.20)	3.48	6.0	7.6	A++
	9	14	-	2.50	4.00	-	6.50 (1.8-8.2)	2.04 (0.35-2.46)	3.19	6.5	7.2	A++
	9	18	-	2.27	4.53	-	6.80 (1.8-8.5)	2.26 (0.35-2.65)	3.01	6.8	6.9	A++
	12	12	-	3.40	3.40	-	6.80 (1.8-8.5)	2.26 (0.35-2.65)	3.01	6.8	6.9	A++
	12	14	-	3.14	3.66	-	6.80 (1.8-8.5)	2.26 (0.35-2.65)	3.01	6.8	6.9	A++
	12	18	-	2.72	4.08	-	6.80 (1.8-8.5)	2.26 (0.35-2.65)	3.01	6.8	6.9	A++
	14	14	-	3.40	3.40	-	6.80 (1.8-8.5)	2.26 (0.35-2.65)	3.01	6.8	6.9	A++
	14	18	-	2.98	3.82	-	6.80 (1.8-8.5)	2.26 (0.35-2.65)	3.01	6.8	6.9	A++
3-unit connection	7	7	7	2.00	2.00	2.00	6.00 (1.8-7.5)	1.37 (0.35-2.20)	4.37	6.0	8.6	A+++
	7	7	9	2.00	2.00	2.50	6.50 (1.8-8.2)	1.59 (0.35-2.46)	4.08	6.5	8.5	A+++
	7	7	12	1.83	1.83	3.14	6.80 (1.8-8.5)	1.74 (0.35-2.65)	3.90	6.8	8.5	A+++
	7	7	14	1.70	1.70	3.40	6.80 (1.8-8.5)	1.74 (0.35-2.65)	3.90	6.8	8.5	A+++
	7	7	18	1.49	1.49	3.82	6.80 (1.8-8.5)	1.74 (0.35-2.65)	3.90	6.8	8.5	A+++
	7	9	9	1.90	2.45	2.45	6.80 (1.8-8.5)	1.74 (0.35-2.65)	3.90	6.8	8.5	A+++
	7	9	12	1.70	2.19	2.91	6.80 (1.8-8.5)	1.74 (0.35-2.65)	3.90	6.8	8.5	A+++
	7	9	14	1.59	2.04	3.17	6.80 (1.8-8.5)	1.74 (0.35-2.65)	3.90	6.8	8.5	A+++
	7	9	18	1.40	1.80	3.60	6.80 (1.8-8.5)	1.74 (0.35-2.65)	3.90	6.8	8.5	A+++
	7	12	12	1.54	2.63	2.63	6.80 (1.8-8.5)	1.74 (0.35-2.65)	3.90	6.8	8.5	A+++
	7	12	14	1.44	2.47	2.89	6.80 (1.8-8.5)	1.74 (0.35-2.65)	3.90	6.8	8.5	A+++
	7	14	14	1.36	2.72	2.72	6.80 (1.8-8.5)	1.74 (0.35-2.65)	3.90	6.8	8.5	A+++
	9	9	9	2.27	2.27	2.27	6.80 (1.8-8.5)	1.74 (0.35-2.65)	3.90	6.8	8.5	A+++
	9	9	12	2.04	2.04	2.72	6.80 (1.8-8.5)	1.74 (0.35-2.65)	3.90	6.8	8.5	A+++
	9	9	14	1.91	1.91	2.98	6.80 (1.8-8.5)	1.74 (0.35-2.65)	3.90	6.8	8.5	A+++
	9	9	18	1.70	1.70	3.40	6.80 (1.8-8.5)	1.74 (0.35-2.65)	3.90	6.8	8.5	A+++
	9	12	12	1.86	2.47	2.47	6.80 (1.8-8.5)	1.74 (0.35-2.65)	3.90	6.8	8.5	A+++
	9	12	14	1.75	2.33	2.72	6.80 (1.8-8.5)	1.74 (0.35-2.65)	3.90	6.8	8.5	A+++
12	12	12	2.27	2.27	2.27	6.80 (1.8-8.5)	1.74 (0.35-2.65)	3.90	6.8	8.5	A+++	

Notes: •7: 7000 Btu/h/9: 9000 Btu/h/12: 12000 Btu/h/14: 14000 Btu/h/18: 18000 Btu/h models
 •The above specifications apply when connected with a wall-mounted [KG/KM] unit.
 •2 or more indoor units should be connected.
 •Cooling capacity is determined based on 27°CDB/19°CWB (indoor temperature) and 35°CDB (outdoor temperature).
 •Pipe Length: 5 m, Height difference: 0 m (Outdoor unit to Indoor unit)
 •Total capacity of indoor units connected must be between 4.0 kW and 10.5 kW.
 •Please refer to the Design & Technical manual for the combination tables with 5kW model.

3-unit Multi-split heating

AOHG18KBTA3	Combination of Indoor Units			Heating Operation					Seasonal Data			
				Heating Capacity			Input Power (Min. - Max.) kW	COP	Pdesign kW	SCOP	Energy efficiency	
				Unit 1 kW	Unit 2 kW	Unit 3 kW						Total Capacity (Min. - Max.) kW
2-unit connection	7	7	-	2.40	2.40	-	4.80 (2.0-5.6)	1.00 (0.25-1.30)	4.80	4.0	4.2	A+
	7	9	-	2.40	3.00	-	5.40 (2.0-6.4)	1.21 (0.25-1.48)	4.45	4.0	4.2	A+
	7	12	-	2.40	4.20	-	6.60 (2.0-7.6)	1.66 (0.25-1.76)	3.98	5.0	4.0	A+
	7	14	-	2.27	4.53	-	6.80 (2.0-8.0)	1.77 (0.25-1.85)	3.84	5.0	4.0	A+
	9	9	-	3.00	3.00	-	6.00 (2.0-7.2)	1.44 (0.25-1.67)	4.17	4.5	4.1	A+
	9	12	-	2.91	3.89	-	6.80 (2.0-8.0)	1.77 (0.25-1.85)	3.84	5.0	4.0	A+
	9	14	-	2.66	4.14	-	6.80 (2.0-8.0)	1.77 (0.25-1.85)	3.84	5.0	4.0	A+
	12	12	-	3.40	3.40	-	6.80 (2.0-8.0)	1.77 (0.25-1.85)	3.84	5.0	4.0	A+
	12	14	-	3.14	3.66	-	6.80 (2.0-8.0)	1.77 (0.25-1.85)	3.84	5.0	4.0	A+
	14	14	-	3.40	3.40	-	6.80 (2.0-8.0)	1.77 (0.25-1.85)	3.84	5.0	4.0	A+
3-unit connection	7	7	7	2.27	2.27	2.27	6.80 (2.0-8.0)	1.39 (0.25-1.85)	4.89	5.0	4.7	A++
	7	7	9	2.07	2.07	2.66	6.80 (2.0-8.0)	1.39 (0.25-1.85)	4.89	5.0	4.7	A++
	7	7	12	1.83	1.83	3.14	6.80 (2.0-8.0)	1.39 (0.25-1.85)	4.89	5.0	4.7	A++
	7	7	14	1.70	1.70	3.40	6.80 (2.0-8.0)	1.39 (0.25-1.85)	4.89	5.0	4.7	A++
	7	9	9	1.90	2.45	2.45	6.80 (2.0-8.0)	1.39 (0.25-1.85)	4.89	5.0	4.7	A++
	7	9	12	1.70	2.19	2.91	6.80 (2.0-8.0)	1.39 (0.25-1.85)	4.89	5.0	4.7	A++
	7	9	14	1.59	2.04	3.17	6.80 (2.0-8.0)	1.39 (0.25-1.85)	4.89	5.0	4.7	A++
	9	9	9	2.27	2.27	2.27	6.80 (2.0-8.0)	1.39 (0.25-1.85)	4.89	5.0	4.7	A++
	9	9	12	2.04	2.04	2.72	6.80 (2.0-8.0)	1.39 (0.25-1.85)	4.89	5.0	4.7	A++

AOHG24KBTA3	Combination of Indoor Units			Heating Operation					Seasonal Data			
				Heating Capacity			Input Power (Min. - Max.) kW	COP	Pdesign kW	SCOP	Energy efficiency	
				Unit 1 kW	Unit 2 kW	Unit 3 kW						Total Capacity (Min. - Max.) kW
2-unit connection	7	7	-	2.40	2.40	-	4.80 (2.0-5.6)	1.00 (0.25-1.30)	4.80	4.0	4.2	A+
	7	9	-	2.40	3.00	-	5.40 (2.0-6.4)	1.21 (0.25-1.48)	4.45	4.0	4.2	A+
	7	12	-	2.40	4.20	-	6.60 (2.0-7.6)	1.66 (0.25-1.76)	3.98	5.0	4.0	A+
	7	14	-	2.40	4.80	-	7.20 (2.0-8.4)	1.86 (0.25-2.07)	3.87	5.4	4.0	A+
	7	18	-	2.16	5.54	-	7.70 (2.0-9.2)	2.01 (0.25-2.35)	3.83	5.8	4.0	A+
	9	9	-	3.00	3.00	-	6.00 (2.0-7.2)	1.44 (0.25-1.67)	4.17	4.5	4.1	A+
	9	12	-	3.00	4.20	-	7.20 (2.0-8.4)	1.86 (0.25-2.07)	3.87	5.4	4.0	A+
	9	14	-	2.96	4.74	-	7.70 (2.0-9.2)	2.01 (0.25-2.35)	3.83	5.8	4.0	A+
	9	18	-	2.57	5.13	-	7.70 (2.0-9.2)	2.01 (0.25-2.35)	3.83	5.8	4.0	A+
	12	12	-	3.85	3.85	-	7.70 (2.0-9.2)	2.01 (0.25-2.35)	3.83	5.8	4.0	A+
	12	14	-	3.55	4.15	-	7.70 (2.0-9.2)	2.01 (0.25-2.35)	3.83	5.8	4.0	A+
	12	18	-	3.08	4.62	-	7.70 (2.0-9.2)	2.01 (0.25-2.35)	3.83	5.8	4.0	A+
	14	14	-	3.85	3.85	-	7.70 (2.0-9.2)	2.01 (0.25-2.35)	3.83	5.8	4.0	A+
	14	18	-	3.37	4.33	-	7.70 (2.0-9.2)	2.01 (0.25-2.35)	3.83	5.8	4.0	A+
3-unit connection	7	7	7	2.40	2.40	2.40	7.20 (2.0-8.4)	1.61 (0.25-2.07)	4.48	5.4	4.7	A++
	7	7	9	2.40	2.40	3.00	7.80 (2.0-9.2)	1.76 (0.25-2.35)	4.42	5.8	4.6	A++
	7	7	12	2.15	2.15	3.70	8.00 (2.0-9.2)	1.82 (0.25-2.35)	4.40	6.0	4.6	A++
	7	7	14	2.00	2.00	4.00	8.00 (2.0-9.2)	1.82 (0.25-2.35)	4.40	6.0	4.6	A++
	7	7	18	1.75	1.75	4.50	8.00 (2.0-9.2)	1.82 (0.25-2.35)	4.40	6.0	4.6	A++
	7	9	9	2.24	2.88	2.88	8.00 (2.0-9.2)	1.82 (0.25-2.35)	4.40	6.0	4.6	A++
	7	9	12	2.00	2.57	3.43	8.00 (2.0-9.2)	1.82 (0.25-2.35)	4.40	6.0	4.6	A++
	7	9	14	1.87	2.40	3.73	8.00 (2.0-9.2)	1.82 (0.25-2.35)	4.40	6.0	4.6	A++
	7	9	18	1.65	2.12	4.23	8.00 (2.0-9.2)	1.82 (0.25-2.35)	4.40	6.0	4	



5-unit Multi-split Combination Table-Cooling

5-unit Multi-split cooling

AOHG36K8TA5	Combination of Indoor Units					Cooling Operation						Seasonal Data					
						Cooling Capacity					Input Power (Min. - Max.)				EER		
						Unit 1	Unit 2	Unit 3	Unit 4	Unit 5		Total Capacity (Min. - Max.)	Pdesign	SEER		Energy efficiency	
2-unit connection	7	24	-	-	-	2.00	7.00	-	-	-	9.00 (3.0-11.0)	2.91 (0.30-3.45)	3.09	9.0	7.9	A++	
	9	22	-	-	-	2.50	6.00	-	-	-	8.50 (3.0-11.0)	2.67 (0.30-3.45)	3.18	8.5	7.9	A++	
	9	24	-	-	-	2.50	7.00	-	-	-	9.50 (3.0-11.0)	3.17 (0.30-3.45)	3.00	9.5	7.8	A++	
	12	22	-	-	-	3.50	6.00	-	-	-	9.50 (3.0-11.0)	3.17 (0.30-3.45)	3.00	9.5	7.8	A++	
	12	24	-	-	-	3.17	6.33	-	-	-	9.50 (3.0-11.0)	3.17 (0.30-3.45)	3.00	9.5	7.8	A++	
	14	22	-	-	-	3.69	5.61	-	-	-	9.50 (3.0-11.0)	3.17 (0.30-3.45)	3.00	9.5	7.8	A++	
	14	24	-	-	-	3.50	6.00	-	-	-	9.50 (3.0-11.0)	3.17 (0.30-3.45)	3.00	9.5	7.8	A++	
	18	18	-	-	-	4.75	4.75	-	-	-	9.50 (3.0-11.0)	3.17 (0.30-3.45)	3.00	9.5	7.8	A++	
	18	22	-	-	-	4.27	5.23	-	-	-	9.50 (3.0-11.0)	3.17 (0.30-3.45)	3.00	9.5	7.8	A++	
	18	24	-	-	-	4.07	5.43	-	-	-	9.50 (3.0-11.0)	3.17 (0.30-3.45)	3.00	9.5	7.8	A++	
	22	22	-	-	-	4.75	4.75	-	-	-	9.50 (3.0-11.0)	3.17 (0.30-3.45)	3.00	9.5	7.8	A++	
	22	24	-	-	-	4.54	4.96	-	-	-	9.50 (3.0-11.0)	3.17 (0.30-3.45)	3.00	9.5	7.8	A++	
	24	24	-	-	-	4.75	4.75	-	-	-	9.50 (3.0-11.0)	3.17 (0.30-3.45)	3.00	9.5	7.8	A++	
	3-unit connection	7	7	14	-	-	2.00	2.00	4.00	-	-	8.00 (3.0-10.0)	2.26 (0.30-2.88)	3.54	8.0	8.2	A++
		7	7	18	-	-	2.00	2.00	5.00	-	-	9.00 (3.0-11.0)	2.68 (0.30-3.45)	3.36	9.0	8.1	A++
		7	7	22	-	-	1.85	1.85	5.80	-	-	9.50 (3.0-11.0)	2.91 (0.30-3.45)	3.27	9.5	8.0	A++
		7	7	24	-	-	1.75	1.75	6.00	-	-	9.50 (3.0-11.0)	2.91 (0.30-3.45)	3.27	9.5	8.0	A++
		7	9	12	-	-	2.00	2.50	3.50	-	-	8.00 (3.0-10.0)	2.26 (0.30-2.88)	3.54	8.0	8.2	A++
		7	9	14	-	-	2.00	2.50	4.00	-	-	8.50 (3.0-10.7)	2.46 (0.30-3.27)	3.45	8.5	8.1	A++
		7	9	18	-	-	2.00	2.50	5.00	-	-	9.50 (3.0-11.0)	2.91 (0.30-3.45)	3.27	9.5	8.0	A++
		7	9	22	-	-	1.75	2.25	5.50	-	-	9.50 (3.0-11.0)	2.91 (0.30-3.45)	3.27	9.5	8.0	A++
		7	9	24	-	-	1.66	2.14	5.70	-	-	9.50 (3.0-11.0)	2.91 (0.30-3.45)	3.27	9.5	8.0	A++
		7	12	12	-	-	2.00	3.50	3.50	-	-	9.00 (3.0-11.0)	2.68 (0.30-3.45)	3.36	9.0	8.1	A++
		7	12	14	-	-	2.00	3.50	4.00	-	-	9.50 (3.0-11.0)	2.91 (0.30-3.45)	3.27	9.5	8.0	A++
7		12	18	-	-	1.80	3.08	4.62	-	-	9.50 (3.0-11.0)	2.91 (0.30-3.45)	3.27	9.5	8.0	A++	
7		12	22	-	-	1.62	2.78	5.10	-	-	9.50 (3.0-11.0)	2.91 (0.30-3.45)	3.27	9.5	8.0	A++	
7		12	24	-	-	1.55	2.65	5.30	-	-	9.50 (3.0-11.0)	2.91 (0.30-3.45)	3.27	9.5	8.0	A++	
7		14	14	-	-	1.90	3.80	3.80	-	-	9.50 (3.0-11.0)	2.91 (0.30-3.45)	3.27	9.5	8.0	A++	
7		14	18	-	-	1.71	3.41	4.38	-	-	9.50 (3.0-11.0)	2.91 (0.30-3.45)	3.27	9.5	8.0	A++	
7		14	22	-	-	1.55	3.09	4.86	-	-	9.50 (3.0-11.0)	2.91 (0.30-3.45)	3.27	9.5	8.0	A++	
7		14	24	-	-	1.47	2.96	5.07	-	-	9.50 (3.0-11.0)	2.91 (0.30-3.45)	3.27	9.5	8.0	A++	
7		18	18	-	-	1.54	3.98	3.98	-	-	9.50 (3.0-11.0)	2.91 (0.30-3.45)	3.27	9.5	8.0	A++	
7		18	22	-	-	1.41	3.64	4.45	-	-	9.50 (3.0-11.0)	2.91 (0.30-3.45)	3.27	9.5	8.0	A++	
7		18	24	-	-	1.36	3.49	4.65	-	-	9.50 (3.0-11.0)	2.91 (0.30-3.45)	3.27	9.5	8.0	A++	
9		9	9	-	-	2.50	2.50	2.50	-	-	7.50 (3.0-9.6)	2.07 (0.30-2.70)	3.63	7.5	8.2	A++	
9		9	12	-	-	2.50	2.50	3.50	-	-	8.50 (3.0-10.7)	2.46 (0.30-3.27)	3.45	8.5	8.1	A++	
9		9	14	-	-	2.50	2.50	4.00	-	-	9.00 (3.0-11.0)	2.68 (0.30-3.45)	3.36	9.0	8.1	A++	
9	9	18	-	-	2.38	2.38	4.74	-	-	9.50 (3.0-11.0)	2.91 (0.30-3.45)	3.27	9.5	8.0	A++		
9	9	22	-	-	2.14	2.14	5.22	-	-	9.50 (3.0-11.0)	2.91 (0.30-3.45)	3.27	9.5	8.0	A++		
9	9	24	-	-	2.04	2.04	5.42	-	-	9.50 (3.0-11.0)	2.91 (0.30-3.45)	3.27	9.5	8.0	A++		
4-unit connection	7	7	7	12	-	2.50	3.50	3.50	-	-	9.50 (3.0-11.0)	2.91 (0.30-3.45)	3.27	9.5	8.0	A++	
	7	7	7	14	-	2.44	3.26	3.80	-	-	9.50 (3.0-11.0)	2.91 (0.30-3.45)	3.27	9.5	8.0	A++	
	7	7	7	18	-	2.19	2.92	4.39	-	-	9.50 (3.0-11.0)	2.91 (0.30-3.45)	3.27	9.5	8.0	A++	
	7	7	7	22	-	1.99	2.65	4.86	-	-	9.50 (3.0-11.0)	2.91 (0.30-3.45)	3.27	9.5	8.0	A++	
	7	7	7	24	-	1.90	2.53	5.07	-	-	9.50 (3.0-11.0)	2.91 (0.30-3.45)	3.27	9.5	8.0	A++	
	7	7	9	12	-	2.32	3.59	3.59	-	-	9.50 (3.0-11.0)	2.91 (0.30-3.45)	3.27	9.5	8.0	A++	
	7	7	9	14	-	2.09	3.24	4.17	-	-	9.50 (3.0-11.0)	2.91 (0.30-3.45)	3.27	9.5	8.0	A++	
	7	7	9	18	-	1.90	2.96	4.64	-	-	9.50 (3.0-11.0)	2.91 (0.30-3.45)	3.27	9.5	8.0	A++	
	7	7	9	22	-	1.82	2.83	4.85	-	-	9.50 (3.0-11.0)	2.91 (0.30-3.45)	3.27	9.5	8.0	A++	
	7	7	9	24	-	1.80	2.80	5.00	-	-	9.50 (3.0-11.0)	2.91 (0.30-3.45)	3.27	9.5	8.0	A++	
	7	7	9	12	12	1.74	3.49	4.27	-	-	9.50 (3.0-11.0)	2.91 (0.30-3.45)	3.27	9.5	8.0	A++	
	7	7	9	12	14	1.68	3.35	4.47	-	-	9.50 (3.0-11.0)	2.91 (0.30-3.45)	3.27	9.5	8.0	A++	
	7	7	9	12	18	3.17	3.17	3.17	-	-	9.50 (3.0-11.0)	2.91 (0.30-3.45)	3.27	9.5	8.0	A++	
	7	7	9	12	22	3.00	3.00	3.50	-	-	9.50 (3.0-11.0)	2.91 (0.30-3.45)	3.27	9.5	8.0	A++	
	7	7	9	12	24	2.71	2.71	4.08	-	-	9.50 (3.0-11.0)	2.91 (0.30-3.45)	3.27	9.5	8.0	A++	
	7	7	9	14	12	2.48	2.48	4.54	-	-	9.50 (3.0-11.0)	2.91 (0.30-3.45)	3.27	9.5	8.0	A++	
	7	7	9	14	14	2.38	2.38	4.74	-	-	9.50 (3.0-11.0)	2.91 (0.30-3.45)	3.27	9.5	8.0	A++	
	7	7	9	14	18	2.84	3.33	3.33	-	-	9.50 (3.0-11.0)	2.91 (0.30-3.45)	3.27	9.5	8.0	A++	
	7	7	9	14	22	2.59	3.02	3.89	-	-	9.50 (3.0-11.0)	2.91 (0.30-3.45)	3.27	9.5	8.0	A++	
	7	7	9	14	24	2.38	2.77	4.35	-	-	9.50 (3.0-11.0)	2.91 (0.30-3.45)	3.27	9.5	8.0	A++	
	7	7	9	18	12	2.28	2.66	4.56	-	-	9.50 (3.0-11.0)	2.91 (0.30-3.45)	3.27	9.5	8.0	A++	
	7	7	9	18	14	2.38	3.56	3.56	-	-	9.50 (3.0-11.0)	2.91 (0.30-3.45)	3.27	9.5	8.0	A++	
	7	7	9	18	18	2.19	3.29	4.02	-	-	9.50 (3.0-11.0)	2.91 (0.30-3.45)	3.27	9.5	8.0	A++	
	7	7	9	18	22	2.11	3.17	4.22	-	-	9.50 (3.0-11.0)	2.91 (0.30-3.45)	3.27	9.5	8.0	A++	
7	7	9	18	24	3.17	3.17	3.17	-	-	9.50 (3.0-11.0)	2.91 (0.30-3.45)	3.27	9.5	8.0	A++		
7	7	9	22	12	2.89	2.89	3.72	-	-	9.50 (3.0-11.0)	2.91 (0.30-3.45)	3.27	9.5	8.0	A++		
7	7	9	22	14	2.66	2.66	4.18	-	-	9.50 (3.0-11.0)	2.91 (0.30-3.45)	3.27	9.5	8.0	A++		
7	7	9	22	18	2.56	2.56	4.38	-	-	9.50 (3.0-11.0)	2.91 (0.30-3.45)	3.27	9.5	8.0	A++		
7	7	9	22	22	2.66	3.42	3.42	-	-	9.50 (3.0-11.0)	2.91 (0.30-3.45)	3.27	9.5	8.0	A++		
7	7	9	22	24	3.17	3.17	3.17	-	-	9.50 (3.0-11.0)	2.91 (0.30-3.45)	3.27	9.5	8.0	A++		
7	7	7	7	7	2.00	2.00	2.00	2.00	-	8.00 (3.0-10.0)	2.11 (0.30-2.88)	3.80	8.0	8.5	A++		
7	7	7	7	9	2.00	2.00	2.00	2.50	-	8.50 (3.0-10.7)	2.29 (0.30-3.27)	3.71	8.5	8.4	A++		
7	7	7	7	12	2.00	2.00	2.00	3.50	-	9.50 (3.0-11.0)	2.69 (0.30-3.45)	3.53	9.5	8.3	A++		
7	7	7	7	14	1.90	1.90	1.90	3.80	-	9.50 (3.0-11.0)	2.69 (0.30-3.45)	3.53	9.5	8.3	A++		
7	7	7	7	18	1.71	1.71	1.71	4.37	-	9.50 (3.0-11.0)	2.69 (0.30-3.45)	3.53	9.5	8.3	A++		
7	7	7	7	22	1.55	1.55	1.55	4.85	-	9.50 (3.0-11.0)	2.69 (0.30-3.45)	3.53	9.5	8.3	A++		
7	7	7	7	24	1.48	1.48	1.48	5.06	-	9.50 (3.0-11.0)	2.69 (0.30-3.45)	3.53	9.5	8.3	A++		
7	7	7	9	9	2.00	2.00	2.50	2.50	-	9.00 (3.0-11.0)	2.49 (0.30-3.45)	3.62	9.0	8.4	A++		
7	7	7	9	12	1.90	1.90	2.44	3.26	-	9.50 (3.0-11.0)	2.69 (0.30-3.45)	3.53	9.5	8.3	A++		
7	7	7	9	14	1.80</												



5-unit Multi-split Combination Table-Heating

5-unit Multi-split heating

AOHG36K8TA5	Combination of Indoor Units					Heating Operation						Seasonal Data					
						Heating Capacity					Input Power (Min. - Max.)	COP	Pdesign kW	SCOP	Energy efficiency		
						Unit 1	Unit 2	Unit 3	Unit 4	Unit 5						Total Capacity (Min. - Max.)	
2-unit connection	7	24	-	-	-	2.39	8.21	-	-	-	10.60 (3.5-12.0)	2.65 (0.25-3.25)	4.00	7.0	4.3	A+	
	9	22	-	-	-	3.00	7.20	-	-	-	10.20 (3.5-12.0)	2.52 (0.25-3.25)	4.04	6.8	4.3	A+	
	9	24	-	-	-	2.89	7.71	-	-	-	10.60 (3.5-12.0)	2.65 (0.25-3.25)	4.00	7.0	4.3	A+	
	12	22	-	-	-	3.74	6.86	-	-	-	10.60 (3.5-12.0)	2.65 (0.25-3.25)	4.00	7.0	4.3	A+	
	12	24	-	-	-	3.53	7.07	-	-	-	10.60 (3.5-12.0)	2.65 (0.25-3.25)	4.00	7.0	4.3	A+	
	14	24	-	-	-	4.12	6.48	-	-	-	10.60 (3.5-12.0)	2.65 (0.25-3.25)	4.00	7.0	4.3	A+	
	14	24	-	-	-	3.91	6.69	-	-	-	10.60 (3.5-12.0)	2.65 (0.25-3.25)	4.00	7.0	4.3	A+	
	18	18	-	-	-	5.30	5.30	-	-	-	10.60 (3.5-12.0)	2.65 (0.25-3.25)	4.00	7.0	4.3	A+	
	18	22	-	-	-	4.77	5.83	-	-	-	10.60 (3.5-12.0)	2.65 (0.25-3.25)	4.00	7.0	4.3	A+	
	18	24	-	-	-	4.54	6.06	-	-	-	10.60 (3.5-12.0)	2.65 (0.25-3.25)	4.00	7.0	4.3	A+	
	22	22	-	-	-	5.30	5.30	-	-	-	10.60 (3.5-12.0)	2.65 (0.25-3.25)	4.00	7.0	4.3	A+	
	22	24	-	-	-	5.07	5.53	-	-	-	10.60 (3.5-12.0)	2.65 (0.25-3.25)	4.00	7.0	4.3	A+	
	24	24	-	-	-	5.30	5.30	-	-	-	10.60 (3.5-12.0)	2.65 (0.25-3.25)	4.00	7.0	4.3	A+	
	3-unit connection	7	7	14	-	-	2.40	2.40	4.80	-	-	9.60 (3.5-11.2)	2.25 (0.25-2.87)	4.26	6.5	4.5	A+
		7	7	18	-	-	2.32	2.32	4.64	-	-	10.60 (3.5-12.0)	2.54 (0.25-3.25)	4.18	7.0	4.4	A+
		7	7	22	-	-	2.06	2.06	4.12	-	-	10.60 (3.5-12.0)	2.54 (0.25-3.25)	4.18	7.0	4.4	A+
		7	7	24	-	-	1.95	1.95	3.90	-	-	10.60 (3.5-12.0)	2.54 (0.25-3.25)	4.18	7.0	4.4	A+
		7	9	12	-	-	2.40	3.00	4.20	-	-	9.60 (3.5-11.2)	2.25 (0.25-2.87)	4.26	6.5	4.5	A+
		7	9	14	-	-	2.40	3.00	4.80	-	-	10.20 (3.5-12.0)	2.42 (0.25-3.25)	4.21	6.8	4.4	A+
		7	9	18	-	-	2.18	2.81	5.61	-	-	10.60 (3.5-12.0)	2.54 (0.25-3.25)	4.18	7.0	4.4	A+
		7	9	22	-	-	1.95	2.51	6.14	-	-	10.60 (3.5-12.0)	2.54 (0.25-3.25)	4.18	7.0	4.4	A+
		7	9	24	-	-	1.85	2.39	6.36	-	-	10.60 (3.5-12.0)	2.54 (0.25-3.25)	4.18	7.0	4.4	A+
		7	12	12	-	-	1.72	4.44	4.44	-	-	10.60 (3.5-12.0)	2.54 (0.25-3.25)	4.18	7.0	4.4	A+
		7	12	14	-	-	2.25	3.85	4.50	-	-	10.60 (3.5-12.0)	2.54 (0.25-3.25)	4.18	7.0	4.4	A+
7		12	18	-	-	2.00	3.44	5.16	-	-	10.60 (3.5-12.0)	2.54 (0.25-3.25)	4.18	7.0	4.4	A+	
7		12	22	-	-	1.81	3.10	5.69	-	-	10.60 (3.5-12.0)	2.54 (0.25-3.25)	4.18	7.0	4.4	A+	
7		12	24	-	-	1.72	2.96	5.92	-	-	10.60 (3.5-12.0)	2.54 (0.25-3.25)	4.18	7.0	4.4	A+	
7		14	14	-	-	2.12	4.24	4.24	-	-	10.60 (3.5-12.0)	2.54 (0.25-3.25)	4.18	7.0	4.4	A+	
7		14	18	-	-	1.90	3.81	4.89	-	-	10.60 (3.5-12.0)	2.54 (0.25-3.25)	4.18	7.0	4.4	A+	
7		14	22	-	-	1.73	3.45	5.42	-	-	10.60 (3.5-12.0)	2.54 (0.25-3.25)	4.18	7.0	4.4	A+	
7		14	24	-	-	1.65	3.30	5.65	-	-	10.60 (3.5-12.0)	2.54 (0.25-3.25)	4.18	7.0	4.4	A+	
7		18	18	-	-	1.72	4.44	4.44	-	-	10.60 (3.5-12.0)	2.54 (0.25-3.25)	4.18	7.0	4.4	A+	
7		18	22	-	-	1.58	4.06	4.96	-	-	10.60 (3.5-12.0)	2.54 (0.25-3.25)	4.18	7.0	4.4	A+	
7		18	24	-	-	1.51	3.89	5.20	-	-	10.60 (3.5-12.0)	2.54 (0.25-3.25)	4.18	7.0	4.4	A+	
9		9	9	-	-	3.00	3.00	3.00	-	-	9.00 (3.5-10.8)	2.09 (0.25-2.70)	4.31	6.0	4.5	A+	
9		9	12	-	-	3.00	3.00	4.20	-	-	10.20 (3.5-12.0)	2.42 (0.25-3.25)	4.21	6.8	4.4	A+	
9		9	14	-	-	2.98	2.98	4.64	-	-	10.60 (3.5-12.0)	2.54 (0.25-3.25)	4.18	7.0	4.4	A+	
9	9	18	-	-	2.65	2.65	5.30	-	-	10.60 (3.5-12.0)	2.54 (0.25-3.25)	4.18	7.0	4.4	A+		
9	9	22	-	-	2.39	2.39	5.82	-	-	10.60 (3.5-12.0)	2.54 (0.25-3.25)	4.18	7.0	4.4	A+		
9	9	24	-	-	2.27	2.27	6.06	-	-	10.60 (3.5-12.0)	2.54 (0.25-3.25)	4.18	7.0	4.4	A+		
9	12	12	-	-	2.80	3.85	4.85	-	-	10.60 (3.5-12.0)	2.54 (0.25-3.25)	4.18	7.0	4.4	A+		
9	12	14	-	-	2.73	3.63	4.24	-	-	10.60 (3.5-12.0)	2.54 (0.25-3.25)	4.18	7.0	4.4	A+		
9	12	18	-	-	2.45	3.26	4.89	-	-	10.60 (3.5-12.0)	2.54 (0.25-3.25)	4.18	7.0	4.4	A+		
9	12	22	-	-	2.22	2.96	5.42	-	-	10.60 (3.5-12.0)	2.54 (0.25-3.25)	4.18	7.0	4.4	A+		
9	12	24	-	-	2.12	2.83	5.65	-	-	10.60 (3.5-12.0)	2.54 (0.25-3.25)	4.18	7.0	4.4	A+		
9	14	14	-	-	2.58	4.01	4.01	-	-	10.60 (3.5-12.0)	2.54 (0.25-3.25)	4.18	7.0	4.4	A+		
9	14	18	-	-	2.33	3.62	4.65	-	-	10.60 (3.5-12.0)	2.54 (0.25-3.25)	4.18	7.0	4.4	A+		
9	14	22	-	-	2.12	3.30	5.18	-	-	10.60 (3.5-12.0)	2.54 (0.25-3.25)	4.18	7.0	4.4	A+		
9	14	24	-	-	2.03	3.16	5.41	-	-	10.60 (3.5-12.0)	2.54 (0.25-3.25)	4.18	7.0	4.4	A+		
9	18	18	-	-	2.12	4.24	4.24	-	-	10.60 (3.5-12.0)	2.54 (0.25-3.25)	4.18	7.0	4.4	A+		
9	18	22	-	-	1.95	3.89	4.76	-	-	10.60 (3.5-12.0)	2.54 (0.25-3.25)	4.18	7.0	4.4	A+		
9	18	24	-	-	1.87	3.74	4.99	-	-	10.60 (3.5-12.0)	2.54 (0.25-3.25)	4.18	7.0	4.4	A+		
12	12	12	-	-	3.53	3.53	3.53	-	-	10.60 (3.5-12.0)	2.54 (0.25-3.25)	4.18	7.0	4.4	A+		
12	12	14	-	-	3.35	3.35	3.90	-	-	10.60 (3.5-12.0)	2.54 (0.25-3.25)	4.18	7.0	4.4	A+		
12	12	18	-	-	3.03	3.03	4.54	-	-	10.60 (3.5-12.0)	2.54 (0.25-3.25)	4.18	7.0	4.4	A+		
12	12	22	-	-	2.77	2.77	5.06	-	-	10.60 (3.5-12.0)	2.54 (0.25-3.25)	4.18	7.0	4.4	A+		
12	12	24	-	-	2.65	2.65	5.30	-	-	10.60 (3.5-12.0)	2.54 (0.25-3.25)	4.18	7.0	4.4	A+		
12	14	14	-	-	3.18	3.71	3.71	-	-	10.60 (3.5-12.0)	2.54 (0.25-3.25)	4.18	7.0	4.4	A+		
12	14	18	-	-	2.89	3.37	4.34	-	-	10.60 (3.5-12.0)	2.54 (0.25-3.25)	4.18	7.0	4.4	A+		
12	14	22	-	-	2.65	3.09	4.86	-	-	10.60 (3.5-12.0)	2.54 (0.25-3.25)	4.18	7.0	4.4	A+		
12	14	24	-	-	2.54	2.97	5.09	-	-	10.60 (3.5-12.0)	2.54 (0.25-3.25)	4.18	7.0	4.4	A+		
12	18	18	-	-	2.64	3.98	3.98	-	-	10.60 (3.5-12.0)	2.54 (0.25-3.25)	4.18	7.0	4.4	A+		
12	18	22	-	-	2.45	3.67	4.48	-	-	10.60 (3.5-12.0)	2.54 (0.25-3.25)	4.18	7.0	4.4	A+		
12	18	24	-	-	2.36	3.53	4.71	-	-	10.60 (3.5-12.0)	2.54 (0.25-3.25)	4.18	7.0	4.4	A+		
14	14	14	-	-	3.53	3.53	3.53	-	-	10.60 (3.5-12.0)	2.54 (0.25-3.25)	4.18	7.0	4.4	A+		
14	14	18	-	-	3.23	3.23	4.14	-	-	10.60 (3.5-12.0)	2.54 (0.25-3.25)	4.18	7.0	4.4	A+		
14	14	22	-	-	2.97	2.97	4.66	-	-	10.60 (3.5-12.0)	2.54 (0.25-3.25)	4.18	7.0	4.4	A+		
14	14	24	-	-	2.89	2.85	4.90	-	-	10.60 (3.5-12.0)	2.54 (0.25-3.25)	4.18	7.0	4.4	A+		
14	18	18	-	-	2.98	3.82	3.82	-	-	10.60 (3.5-12.0)	2.54 (0.25-3.25)	4.18	7.0	4.4	A+		
18	18	18	-	-	3.53	3.53	3.53	-	-	10.60 (3.5-12.0)	2.54 (0.25-3.25)	4.18	7.0	4.4	A+		
4-unit connection	7	7	7	7	-	2.40	2.40	2.40	2.40	-	9.60 (3.5-11.2)	2.17 (0.25-2.87)	4.42	6.5	4.6	A++	
	7	7	7	9	-	2.40	2.40	2.40	3.00	-	10.20 (3.5-12.0)	2.33 (0.25-3.25)	4.37	6.8	4.5	A+	
	7	7	7	12	-	2.25	2.25	2.25	3.85	-	10.60 (3.5-12.0)	2.44 (0.25-3.25)	4.34	7.0	4.5	A+	
	7	7	7	14	-	2.12	2.12	2.12	4.24	-	10.60 (3.5-12.0)	2.44 (0.25-3.25)	4.34	7.0	4.5	A+	
	7	7	7	18	-	1.90	1.90	1.90	4.90	-	10.60 (3.5-12.0)	2.44 (0.25-3.25)	4.34	7.0	4.5	A+	
	7	7	7	22	-	1.73	1.73	1.73	5.41	-	10.60 (3.5-12.0)	2.44 (0.25-3.25)	4.34	7.0	4.5	A+	
	7	7	7	24	-	1.65	1.65	1.65	5.65	-	10.60 (3.5-12.0)	2.44 (0.25-3.25)	4.34	7.0	4.5	A+	
	7	7	9	9	-	2.32	2.32	2.98	2.98	-	10.60 (3.5-12.0)	2.40 (0.25-3.25)	4.34	7.0	4.5	A+	
	7	7	9	12	-	2.12	2.12	2.73	3.63	-	10.60 (3.5-12.0)	2.44 (0.25-3.25)	4.34	7.0	4.5	A+	
	7	7	9	14	-	2.01	2.01	2.57	4								



6-unit Multi-split Combination Table-Cooling

6-unit Multi-split cooling

ADHG45L6A6	Combination of Indoor Units						Cooling Operation				Input Power (Min. - Max.)	EER		
							Cooling Capacity							
							Unit 1	Unit 2	Unit 3	Unit 4			Unit 5	Unit 6
2-unit connection	12	24	-	-	-	-	-	-	-	-	10.5 (3.5-11.5)	3.06 (0.8-3.32)	3.43	
	14	24	-	-	-	-	-	-	-	-	11.0 (3.5-12.1)	3.28 (0.8-3.32)	3.35	
	18	18	-	-	-	-	-	-	-	-	10.0 (3.5-11.5)	2.92 (0.8-3.32)	3.42	
	18	24	-	-	-	-	-	-	-	-	12.0 (3.5-13.4)	3.75 (0.8-4.46)	3.20	
	24	24	-	-	-	-	-	-	-	-	12.5 (3.5-14.0)	4.01 (0.8-4.84)	3.12	
	7	7	24	-	-	-	-	-	-	-	3.19 (0.8-3.70)	3.45	3.38	
	7	9	18	-	-	-	-	-	-	-	9.5 (3.5-10.8)	2.55 (0.8-2.93)	3.73	
	7	9	24	-	-	-	-	-	-	-	11.5 (3.5-12.7)	3.41 (0.8-4.08)	3.37	
	7	12	18	-	-	-	-	-	-	-	10.5 (3.5-11.8)	3.02 (0.8-3.51)	3.48	
	7	12	24	-	-	-	-	-	-	-	12.4 (3.5-13.7)	3.82 (0.8-4.65)	3.25	
	7	14	14	-	-	-	-	-	-	-	10.0 (3.5-11.1)	2.81 (0.8-3.13)	3.56	
	3-unit connection	7	14	18	-	-	-	-	-	-	-	3.23 (0.8-3.89)	3.41	3.41
7		14	24	-	-	-	-	-	-	-	12.5 (3.5-14.0)	3.89 (0.8-4.84)	3.21	
9		14	18	-	-	-	-	-	-	-	3.45 (0.8-4.27)	3.33	3.42	
7		18	24	-	-	-	-	-	-	-	12.5 (3.5-14.0)	3.87 (0.8-4.84)	3.23	
7		24	24	-	-	-	-	-	-	-	12.5 (3.5-14.0)	3.83 (0.8-4.84)	3.26	
9		9	18	-	-	-	-	-	-	-	10.0 (3.5-11.5)	2.84 (0.8-3.32)	3.52	
9		9	24	-	-	-	-	-	-	-	12.0 (3.5-13.4)	3.65 (0.8-4.46)	3.29	
9		12	14	-	-	-	-	-	-	-	10.0 (3.5-11.1)	2.81 (0.8-3.13)	3.56	
9		12	18	-	-	-	-	-	-	-	11.0 (3.5-12.4)	3.23 (0.8-3.89)	3.41	
9		12	24	-	-	-	-	-	-	-	12.5 (3.5-14.0)	3.89 (0.8-4.84)	3.21	
9		14	14	-	-	-	-	-	-	-	10.5 (3.5-11.8)	3.02 (0.8-3.51)	3.48	
9		14	18	-	-	-	-	-	-	-	3.45 (0.8-4.27)	3.33	3.42	
9		14	24	-	-	-	-	-	-	-	12.5 (3.5-14.0)	3.88 (0.8-4.84)	3.22	
9		18	18	-	-	-	-	-	-	-	12.5 (3.5-14.0)	3.89 (0.8-4.84)	3.21	
9		18	24	-	-	-	-	-	-	-	12.5 (3.5-14.0)	3.89 (0.8-4.84)	3.21	
9		18	24	-	-	-	-	-	-	-	12.5 (3.5-14.0)	3.86 (0.8-4.84)	3.24	
9		24	24	-	-	-	-	-	-	-	12.5 (3.5-14.0)	3.82 (0.8-4.84)	3.27	
12		12	12	-	-	-	-	-	-	-	10.5 (3.5-11.5)	2.98 (0.8-3.32)	3.52	
12		12	14	-	-	-	-	-	-	-	11.0 (3.5-12.1)	3.19 (0.8-3.70)	3.45	
12		12	18	-	-	-	-	-	-	-	12.0 (3.5-13.4)	3.65 (0.8-4.46)	3.29	
12		12	24	-	-	-	-	-	-	-	12.5 (3.5-14.0)	3.87 (0.8-4.84)	3.23	
12		14	14	-	-	-	-	-	-	-	3.41 (0.8-4.08)	3.41	3.37	
12		14	18	-	-	-	-	-	-	-	12.5 (3.5-14.0)	3.89 (0.8-4.84)	3.21	
12		14	24	-	-	-	-	-	-	-	12.5 (3.5-14.0)	3.86 (0.8-4.84)	3.24	
12		18	18	-	-	-	-	-	-	-	12.5 (3.5-14.0)	3.87 (0.8-4.84)	3.23	
12		18	24	-	-	-	-	-	-	-	12.5 (3.5-14.0)	3.85 (0.8-4.84)	3.25	
12		24	24	-	-	-	-	-	-	-	12.5 (3.5-14.0)	3.81 (0.8-4.84)	3.28	
14		14	14	-	-	-	-	-	-	-	12.0 (3.5-13.4)	3.65 (0.8-4.46)	3.29	
14		14	18	-	-	-	-	-	-	-	12.5 (3.5-14.0)	3.88 (0.8-4.84)	3.22	
14		14	24	-	-	-	-	-	-	-	12.5 (3.5-14.0)	3.85 (0.8-4.84)	3.25	
14		18	18	-	-	-	-	-	-	-	12.5 (3.5-14.0)	3.85 (0.8-4.84)	3.25	
14		18	24	-	-	-	-	-	-	-	12.5 (3.5-14.0)	3.85 (0.8-4.84)	3.25	
14		24	24	-	-	-	-	-	-	-	12.5 (3.5-14.0)	3.83 (0.8-4.84)	3.26	
14		24	24	-	-	-	-	-	-	-	12.5 (3.5-14.0)	3.80 (0.8-4.84)	3.29	
18		18	18	-	-	-	-	-	-	-	12.5 (3.5-14.0)	3.85 (0.8-4.84)	3.25	
18		18	24	-	-	-	-	-	-	-	12.5 (3.5-14.0)	3.81 (0.8-4.84)	3.28	
7		7	7	14	-	-	-	-	-	-	10.0 (3.5-11.1)	2.50 (0.8-3.13)	4.00	
7		7	7	18	-	-	-	-	-	-	11.0 (3.5-12.4)	3.06 (0.8-3.89)	3.59	
7		7	7	24	-	-	-	-	-	-	12.5 (3.5-14.0)	3.77 (0.8-4.84)	3.32	
7		7	9	12	-	-	-	-	-	-	10.0 (3.5-11.1)	2.50 (0.8-3.13)	4.00	
7		7	9	18	-	-	-	-	-	-	11.5 (3.5-12.7)	3.33 (0.8-4.08)	3.45	
7		7	9	24	-	-	-	-	-	-	12.5 (3.5-14.0)	3.75 (0.8-4.84)	3.33	
7		7	12	12	-	-	-	-	-	-	11.0 (3.5-12.1)	3.00 (0.8-3.70)	3.67	
7		7	12	14	-	-	-	-	-	-	11.5 (3.5-12.7)	3.27 (0.8-4.08)	3.52	
7		7	12	18	-	-	-	-	-	-	12.5 (3.5-14.0)	3.78 (0.8-4.84)	3.31	
7		7	12	24	-	-	-	-	-	-	12.5 (3.5-14.0)	3.74 (0.8-4.84)	3.34	
7		7	14	14	-	-	-	-	-	-	12.0 (3.5-13.4)	3.51 (0.8-4.46)	3.42	
7		7	14	18	-	-	-	-	-	-	12.5 (3.5-14.0)	3.77 (0.8-4.84)	3.32	
7	7	14	24	-	-	-	-	-	-	12.5 (3.5-14.0)	3.73 (0.8-4.84)	3.35		
7	7	18	18	-	-	-	-	-	-	12.5 (3.5-14.0)	3.74 (0.8-4.84)	3.34		
7	7	18	24	-	-	-	-	-	-	12.5 (3.5-14.0)	3.70 (0.8-4.84)	3.38		
7	7	24	24	-	-	-	-	-	-	12.5 (3.5-14.0)	3.67 (0.8-4.84)	3.41		
7	9	9	9	-	-	-	-	-	-	9.5 (3.5-10.8)	2.31 (0.8-2.93)	4.11		
7	9	9	12	-	-	-	-	-	-	10.5 (3.5-11.8)	2.79 (0.8-3.51)	3.76		
7	9	9	14	-	-	-	-	-	-	11.0 (3.5-12.4)	3.06 (0.8-3.89)	3.59		
7	9	9	18	-	-	-	-	-	-	12.0 (3.5-13.4)	3.57 (0.8-4.65)	3.36		
7	9	9	24	-	-	-	-	-	-	12.5 (3.5-14.0)	3.74 (0.8-4.84)	3.34		
7	9	12	12	-	-	-	-	-	-	11.5 (3.5-12.7)	3.27 (0.8-4.08)	3.52		
7	9	12	14	-	-	-	-	-	-	12.0 (3.5-13.4)	3.50 (0.8-4.27)	3.40		
7	9	12	18	-	-	-	-	-	-	12.5 (3.5-14.0)	3.77 (0.8-4.84)	3.32		
7	9	12	24	-	-	-	-	-	-	12.5 (3.5-14.0)	3.73 (0.8-4.84)	3.35		
7	9	14	14	-	-	-	-	-	-	12.5 (3.5-14.0)	3.78 (0.8-4.84)	3.31		
7	9	14	18	-	-	-	-	-	-	12.5 (3.5-14.0)	3.75 (0.8-4.84)	3.33		
7	9	14	24	-	-	-	-	-	-	12.5 (3.5-14.0)	3.71 (0.8-4.84)	3.37		
7	9	18	18	-	-	-	-	-	-	12.5 (3.5-14.0)	3.73 (0.8-4.84)	3.35		
7	9	18	24	-	-	-	-	-	-	12.5 (3.5-14.0)	3.69 (0.8-4.84)	3.39		
7	12	12	12	-	-	-	-	-	-	12.4 (3.5-13.7)	3.69 (0.8-4.65)	3.39		
7	12	12	14	-	-	-	-	-	-	12.5 (3.5-14.0)	3.77 (0.8-4.84)	3.32		
7	12	12	18	-	-	-	-	-	-	12.5 (3.5-14.0)	3.74 (0.8-4.84)	3.34		
7	12	12	24	-	-	-	-	-	-	12.5 (3.5-14.0)	3.71 (0.8-4.84)	3.37		
7	12	14	14	-	-	-	-	-	-	12.5 (3.5-14.0)	3.75 (0.8-4.84)	3.33		
7	12	14	18	-	-	-	-	-	-	12.5 (3.5-14.0)	3.73 (0.8-4.84)	3.35		
7	12	14	24	-	-	-	-	-	-	12.5 (3.5-14.0)	3.70 (0.8-4.84)	3.38		
7	12	18	18	-	-	-	-	-	-	12.5 (3.5-14.0)	3.71 (0.8-4.84)	3.37		
7	12	18	24	-	-	-	-	-	-	12.5 (3.5-14.0)	3.68 (0.8-4.84)	3.40		
7	12	24	24	-	-	-	-	-	-	12.5 (3.5-14.0)	3.68 (0.8-4.84)	3.40		
9	9	9	9	-	-	-	-	-	-	10.0 (3.5-11.5)	2.59 (0.8-3.32)	3.86		
9	9	9	12	-	-	-	-	-	-	11.0 (3.5-12.4)	3.06 (0.8-3.89)	3.59		
9	9	9	14	-	-	-	-	-	-	11.5 (3.5-12.7)	3.33 (0.8-4.08)	3.45		
9	9	9	18	-	-	-	-	-	-	12.5 (3.5-14.0)	3.77 (0.8-4.84)	3.32		
9	9	9	24	-	-	-	-	-	-	12.5 (3.5-14.0)	3.73 (0.8-4.84)	3.35		
9	9	12	12	-	-	-	-	-	-	12.5 (3.5-14.0)	3.78 (0.8-4.84)	3.31		
9	9	12	14	-	-	-	-	-	-	12.5 (3.5-14.0)	3.75 (0.8-4.84)	3.33		
9	9	12	18	-	-	-	-	-	-	12.5 (3.5-14.0)	3.73 (0.8-4.84)	3.35		
9	9	12	24	-	-	-	-	-	-	12.5 (3.5-14.0)	3.69 (0.8-4.84)	3.39		
9	9	14	14	-	-	-	-	-	-	12.5 (3.5-14.0)	3.74 (0.8-4.84)	3.34		
9	9	14	18	-	-	-	-	-	-	12.5 (3.5-14.0)	3.71 (0.8-4.84)	3.37		
9	9	14	24	-	-	-	-	-	-	12.5 (3.5-14.0)	3.68 (0.8-4.84)	3.40		
9														

6-unit Multi-split Multi Combination Table-Cooling/Heating

6-unit Multi-split cooling

ADHG45LBLA6	Combination of Indoor Units		Cooling Operation						Input Power (Min. - Max.)	EER
			Cooling Capacity							
			Unit 1	Unit 2	Unit 3	Unit 4	Unit 5	Unit 6		
			kW	kW	kW	kW	kW	kW	kW	kW
	7	7	2.00	2.00	2.00	2.00	2.00	12.0 (3.5-13.4)	3.32 (0.8-4.46)	3.61
	7	7	2.00	2.00	2.00	2.00	2.50	12.5 (3.5-14.0)	3.57 (0.8-4.84)	3.50
	7	7	1.86	1.86	1.86	1.86	3.20	12.5 (3.5-14.0)	3.55 (0.8-4.84)	3.52
	7	7	1.79	1.79	1.79	1.79	3.55	12.5 (3.5-14.0)	3.54 (0.8-4.84)	3.53
	7	7	1.65	1.65	1.65	1.65	4.25	12.5 (3.5-14.0)	3.51 (0.8-4.84)	3.56
	7	7	1.48	1.48	1.48	1.48	5.10	12.5 (3.5-14.0)	3.48 (0.8-4.84)	3.59
	7	7	1.90	1.90	1.90	2.45	2.45	12.5 (3.5-14.0)	3.56 (0.8-4.84)	3.51
	7	7	1.79	1.79	1.79	2.29	3.05	12.5 (3.5-14.0)	3.54 (0.8-4.84)	3.53
	7	7	1.72	1.72	1.72	2.20	3.42	12.5 (3.5-14.0)	3.53 (0.8-4.84)	3.54
	7	7	1.59	1.59	1.59	2.05	4.09	12.5 (3.5-14.0)	3.50 (0.8-4.84)	3.57
	7	7	1.43	1.43	1.43	1.85	4.93	12.5 (3.5-14.0)	3.47 (0.8-4.84)	3.60
	7	7	1.68	1.68	1.68	2.89	2.89	12.5 (3.5-14.0)	3.52 (0.8-4.84)	3.55
	7	7	1.62	1.62	1.62	2.78	3.24	12.5 (3.5-14.0)	3.51 (0.8-4.84)	3.56
	7	7	1.51	1.51	1.51	2.59	3.87	12.5 (3.5-14.0)	3.48 (0.8-4.84)	3.60
	7	7	1.56	1.56	1.56	3.13	3.13	12.5 (3.5-14.0)	3.50 (0.8-4.84)	3.57
	7	7	1.46	1.46	1.46	2.92	3.74	12.5 (3.5-14.0)	3.47 (0.8-4.84)	3.60
	7	7	1.82	1.82	1.82	2.34	2.34	12.5 (3.5-14.0)	3.55 (0.8-4.84)	3.52
	7	7	1.72	1.72	1.72	2.21	2.21	12.5 (3.5-14.0)	3.53 (0.8-4.84)	3.54
	7	7	1.65	1.65	1.65	2.12	2.12	12.5 (3.5-14.0)	3.51 (0.8-4.84)	3.56
	7	7	1.54	1.54	1.54	1.97	3.94	12.5 (3.5-14.0)	3.49 (0.8-4.84)	3.58
	7	7	1.62	1.62	1.62	2.08	2.78	12.5 (3.5-14.0)	3.51 (0.8-4.84)	3.56
	7	7	1.56	1.56	1.56	2.01	2.68	12.5 (3.5-14.0)	3.50 (0.8-4.84)	3.57
	7	7	1.46	1.46	1.46	1.88	2.50	12.5 (3.5-14.0)	3.47 (0.8-4.84)	3.60
	7	7	1.51	1.51	1.51	1.93	3.02	12.5 (3.5-14.0)	3.48 (0.8-4.84)	3.59
	7	7	1.54	1.54	1.54	2.63	2.63	12.5 (3.5-14.0)	3.49 (0.8-4.84)	3.58
	7	7	1.48	1.48	1.48	2.54	2.54	12.5 (3.5-14.0)	3.48 (0.8-4.84)	3.59
	7	7	1.43	1.43	1.43	2.47	2.87	12.5 (3.5-14.0)	3.47 (0.8-4.84)	3.60
	7	7	1.75	1.75	1.75	2.25	2.25	12.5 (3.5-14.0)	3.53 (0.8-4.84)	3.54
	7	7	1.65	1.65	1.65	2.12	2.12	12.5 (3.5-14.0)	3.51 (0.8-4.84)	3.56
	7	7	1.59	1.59	1.59	2.05	2.05	12.5 (3.5-14.0)	3.50 (0.8-4.84)	3.57
	7	7	1.48	1.48	1.48	1.91	3.81	12.5 (3.5-14.0)	3.48 (0.8-4.84)	3.59
	7	7	1.46	1.46	1.46	2.01	2.68	12.5 (3.5-14.0)	3.50 (0.8-4.84)	3.57
	7	7	1.51	1.51	1.51	1.94	2.59	12.5 (3.5-14.0)	3.48 (0.8-4.84)	3.59
	7	7	1.41	1.41	1.41	1.81	2.42	12.5 (3.5-14.0)	3.46 (0.8-4.84)	3.61
	7	7	1.46	1.46	1.46	1.88	2.91	12.5 (3.5-14.0)	3.47 (0.8-4.84)	3.60
	7	7	1.48	1.48	1.48	1.92	2.54	12.5 (3.5-14.0)	3.48 (0.8-4.84)	3.59
	7	7	1.43	1.43	1.43	1.85	2.46	12.5 (3.5-14.0)	3.47 (0.8-4.84)	3.60
	7	7	1.41	1.41	1.41	2.42	2.42	12.5 (3.5-14.0)	3.46 (0.8-4.84)	3.61
	7	7	1.70	1.70	1.70	2.16	2.16	12.5 (3.5-14.0)	3.52 (0.8-4.84)	3.55
	7	7	1.59	1.59	1.59	2.05	2.05	12.5 (3.5-14.0)	3.50 (0.8-4.84)	3.57
	7	7	1.56	1.56	1.56	2.01	2.68	12.5 (3.5-14.0)	3.49 (0.8-4.84)	3.58
	7	7	1.54	1.54	1.54	1.97	3.08	12.5 (3.5-14.0)	3.49 (0.8-4.84)	3.58
	7	7	1.50	1.50	1.50	1.94	2.59	12.5 (3.5-14.0)	3.48 (0.8-4.84)	3.59
	7	7	1.46	1.46	1.46	1.88	2.50	12.5 (3.5-14.0)	3.47 (0.8-4.84)	3.60
	7	7	1.44	1.44	1.44	1.84	2.46	12.5 (3.5-14.0)	3.47 (0.8-4.84)	3.60
	9	9	2.08	2.08	2.08	2.08	2.08	12.5 (3.5-14.0)	3.51 (0.8-4.84)	3.56
	9	9	1.97	1.97	1.97	1.97	2.65	12.5 (3.5-14.0)	3.49 (0.8-4.84)	3.58
	9	9	1.88	1.88	1.88	1.88	2.49	12.5 (3.5-14.0)	3.47 (0.8-4.84)	3.60

- Notes: •7: 7000 Btu/h/9: 9000 Btu/h/12: 12000 Btu/h/14: 14000 Btu/h/18: 18000 Btu/h/24: 24000 Btu/h models
 •The above specifications apply when connected with a wall-mounted unit.
 •2 or more indoor units should be connected.
 •Cooling capacity is determined based on 27°CDB/19°CWB (indoor temperature) and 35°CDB (outdoor temperature).
 •Pipe Length: 5 m, Height difference: 0 m (Outdoor unit to Indoor unit)
 •Total capacity of indoor units connected must be between 9.5 kW and 18.0 kW.

6-unit Multi-split heating

ADHG45LBLA6	Combination of Indoor Units		Heating Operation						Input Power (Min. - Max.)	COP				
			Heating Capacity											
			Unit 1	Unit 2	Unit 3	Unit 4	Unit 5	Unit 6			Total Capacity (Min. - Max.)			
			kW	kW	kW	kW	kW	kW	kW	kW				
	2	Units	12	24	-	-	-	4.07	8.13	-	-	12.2 (3.5-13.1)	3.41 (0.7-3.54)	3.58
	14	24	-	-	-	-	4.61	7.89	-	-	-	12.5 (3.5-13.8)	3.56 (0.7-3.76)	3.51
	18	18	-	-	-	-	6.10	6.10	-	-	-	12.2 (3.5-13.1)	3.41 (0.7-3.54)	3.58
	18	24	-	-	-	-	5.66	7.54	-	-	-	13.2 (3.5-15.3)	3.78 (0.7-4.20)	3.49
	24	24	-	-	-	-	6.75	6.75	-	-	-	13.5 (3.5-16.0)	3.89 (0.7-4.41)	3.47
	7	7	24	-	-	-	2.30	2.30	7.90	-	-	12.5 (3.5-13.8)	3.43 (0.7-3.76)	3.64
	7	9	18	-	-	-	2.35	3.02	6.03	-	-	11.4 (3.5-12.4)	2.98 (0.7-3.33)	3.83
	7	9	24	-	-	-	2.24	2.88	7.68	-	-	12.8 (3.5-14.5)	3.54 (0.7-3.98)	3.62
	7	12	18	-	-	-	2.33	3.99	5.98	-	-	12.3 (3.5-13.5)	3.35 (0.7-3.65)	3.67
	7	12	24	-	-	-	2.17	3.71	7.42	-	-	13.3 (3.5-15.6)	3.69 (0.7-4.30)	3.60
	7	14	14	-	-	-	2.40	4.80	4.80	-	-	12.0 (3.5-12.7)	3.15 (0.7-3.44)	3.81
	7	14	18	-	-	-	2.28	4.56	5.86	-	-	12.7 (3.5-14.2)	3.49 (0.7-3.87)	3.64
	7	14	24	-	-	-	2.10	4.20	7.20	-	-	13.5 (3.5-16.0)	3.75 (0.7-4.41)	3.60
	7	18	18	-	-	-	2.16	5.57	5.57	-	-	13.3 (3.5-15.6)	3.60 (0.7-4.30)	3.60
	7	18	24	-	-	-	1.93	4.96	6.61	-	-	13.5 (3.5-16.0)	3.74 (0.7-4.41)	3.61
	7	24	24	-	-	-	1.72	5.89	5.89	-	-	13.5 (3.5-16.0)	3.72 (0.7-4.41)	3.63
	9	9	18	-	-	-	3.05	3.05	6.10	-	-	12.2 (3.5-13.1)	3.28 (0.7-3.54)	3.72
	9	9	24	-	-	-	2.83	2.83	7.54	-	-	13.2 (3.5-15.3)	3.64 (0.7-4.20)	3.63
	9	12	14	-	-	-	3.09	4.11	4.80	-	-	12.0 (3.5-12.7)	3.15 (0.7-3.44)	3.81
	9	12	18	-	-	-	2.93	3.91	5.86	-	-	12.7 (3.5-14.2)	3.49 (0.7-3.87)	3.64
	9	12	24	-	-	-	2.70	3.60	7.20	-	-	13.5 (3.5-16.0)	3.75 (0.7-4.41)	3.60
	9	14	14	-	-	-	3.00	4.65	4.65	-	-	12.3 (3.5-13.5)	3.35 (0.7-3.65)	3.67
	9	14	18	-	-	-	2.85	4.44	5.71	-	-	13.0 (3.5-14.9)	3.59 (0.7-4.09)	3.62
	9	14	24	-	-	-	2.59	4.02	6.89	-	-	13.5 (3.5-16.0)	3.74 (0.7-4.41)	3.61
	9	18	18	-	-	-	2.70	5.40	5.40	-	-	13.5 (3.5-16.0)	3.75 (0.7-4.41)	3.60
	9	18	24	-	-	-	2.38	4.76	6.36	-	-	13.5 (3.5-16.0)	3.73 (0.7-4.41)	3.62
	9	24	24	-	-	-	2.14	5.68	5.68	-	-	13.5 (3.5-16.0)	3.71 (0.7-4.41)	3.64
	12	12	12	-	-	-	4.07	4.07	4.07	-	-	12.2 (3.5-13.1)	3.28 (0.7-3.54)	3.72
	12	12	14	-	-	-	3.94	3.95	4.61	-	-	12.5 (3.5-13.8)	3.43 (0.7-3.76)	3.64
	12	12	18	-	-	-	3.77	3.77	5.66	-	-	13.2 (3.5-15.3)	3.64 (0.7-4.20)	3.63
	12	12	24	-	-	-	3.38	3.38	6.74	-	-	13.5 (3.5-16.0)	3.74 (0.7-4.41)	3.61
	12	14	14	-	-	-	3.84	4.48	4.48	-	-	12.8 (3.5-14.5)	3.54 (0.7-3.98)	3.62
	12	14	18	-	-	-	3.68	4.30	5.52	-	-	13.5 (3.5-16.0)	3.75 (0.7-4.41)	3.60
	12	14	24	-	-	-	3.24	3.78	6.48	-	-	13.5 (3.5-16.0)	3.74 (0.7-4.41)	3.61
	12	18	18	-	-	-	3.38	5.06	5.06	-	-	13.5 (3.5-16.0)	3.74 (0.7-4.41)	3.61
	12	18	24	-	-	-	3.00	4.50	6.00	-	-	13.5 (3.5-16.0)	3.72 (0.7-4.41)	3.63
	12	24	24	-	-	-	2.70	5.40	5.40	-	-	13.5 (3.5-16.0)	3.71 (0.7-4.41)	3.64
	14	14	14	-	-	-	4.40	4.40	4.40	-	-			

6-unit Multi-split Combination Table-Heating

6-unit Multi-split heating















































ADHG45LBLA6	Combination of Indoor Units		Heating Operation						Input Power (Min. - Max.)	COP
			Heating Capacity							
			Unit 1	Unit 2	Unit 3	Unit 4	Unit 5	Unit 6		
			kW	kW	kW	kW	kW	kW	kW	kW
4-unit connection	12	12	3.38	3.38	3.38	3.38	3.38	13.5 (3.5-16.0)	3.60 (0.7-4.4)	3.75
	12	12	3.24	3.24	3.24	3.78	-	13.5 (3.5-16.0)	3.60 (0.7-4.4)	3.75
	12	12	3.00	3.00	3.00	4.50	-	13.5 (3.5-16.0)	3.58 (0.7-4.4)	3.77
	12	12	2.70	2.70	2.70	5.40	-	13.5 (3.5-16.0)	3.57 (0.7-4.4)	3.78
	12	12	3.12	3.12	3.63	3.63	-	13.5 (3.5-16.0)	3.59 (0.7-4.4)	3.76
	12	14	2.89	2.89	3.38	4.34	-	13.5 (3.5-16.0)	3.58 (0.7-4.4)	3.77
	12	14	2.61	2.61	3.05	5.23	-	13.5 (3.5-16.0)	3.56 (0.7-4.4)	3.79
	12	18	2.70	2.70	4.05	4.05	-	13.5 (3.5-16.0)	3.57 (0.7-4.4)	3.78
	12	14	3.00	3.50	3.50	3.50	-	13.5 (3.5-16.0)	3.58 (0.7-4.4)	3.77
	12	14	2.79	3.26	3.26	4.19	-	13.5 (3.5-16.0)	3.57 (0.7-4.4)	3.78
	12	14	2.61	3.05	3.92	3.92	-	13.5 (3.5-16.0)	3.56 (0.7-4.4)	3.79
	5-unit connection	7	7	2.40	2.40	2.40	2.40	2.40	12.0 (3.5-12.7)	2.82 (0.7-3.44)
7		7	2.33	2.33	2.33	2.98	-	12.3 (3.5-13.5)	3.03 (0.7-3.65)	4.06
7		7	2.20	2.20	2.20	3.60	-	12.8 (3.5-14.5)	3.29 (0.7-3.98)	3.89
7		7	2.20	2.20	2.20	4.40	-	13.2 (3.5-15.3)	3.40 (0.7-4.20)	3.88
7		7	2.05	2.05	2.05	5.30	-	13.5 (3.5-16.0)	3.49 (0.7-4.4)	3.87
7		7	1.82	1.82	1.82	6.22	-	13.5 (3.5-16.0)	3.47 (0.7-4.4)	3.89
7		7	2.28	2.28	2.28	2.93	2.93	12.7 (3.5-14.2)	3.23 (0.7-3.87)	3.93
7		7	2.20	2.20	2.20	2.83	3.77	13.2 (3.5-15.3)	3.40 (0.7-4.20)	3.88
7		7	2.15	2.15	2.15	2.76	4.29	13.5 (3.5-16.0)	3.49 (0.7-4.4)	3.87
7		7	1.97	1.97	1.97	2.53	5.06	13.5 (3.5-16.0)	3.48 (0.7-4.4)	3.88
7		7	1.75	1.75	1.75	2.25	6.00	13.5 (3.5-16.0)	3.46 (0.7-4.4)	3.90
7		7	2.01	2.01	2.01	3.60	-	13.5 (3.5-16.0)	3.49 (0.7-4.4)	3.87
7	7	1.85	1.85	1.85	4.02	-	13.5 (3.5-16.0)	3.48 (0.7-4.4)	3.88	
7	7	1.66	1.66	1.66	4.77	-	13.5 (3.5-16.0)	3.47 (0.7-4.4)	3.89	
7	7	1.93	1.93	1.93	5.68	-	13.5 (3.5-16.0)	3.45 (0.7-4.4)	3.91	
7	7	1.78	1.78	1.78	3.86	3.86	13.5 (3.5-16.0)	3.48 (0.7-4.4)	3.88	
7	7	1.60	1.60	1.60	4.59	-	13.5 (3.5-16.0)	3.47 (0.7-4.4)	3.89	
7	7	1.66	1.66	1.66	5.50	-	13.5 (3.5-16.0)	3.45 (0.7-4.4)	3.91	
7	7	2.22	2.22	2.85	2.85	-	13.0 (3.5-14.9)	3.34 (0.7-4.09)	3.89	
7	7	2.15	2.15	2.76	2.76	-	13.5 (3.5-16.0)	3.49 (0.7-4.4)	3.88	
7	7	2.05	2.05	2.64	2.64	-	13.5 (3.5-16.0)	3.49 (0.7-4.4)	3.87	
7	7	1.89	1.89	2.43	2.43	-	13.5 (3.5-16.0)	3.48 (0.7-4.4)	3.88	
7	7	1.69	1.69	2.17	2.17	-	13.5 (3.5-16.0)	3.46 (0.7-4.4)	3.90	
7	7	2.01	2.01	2.58	3.45	3.45	13.5 (3.5-16.0)	3.48 (0.7-4.4)	3.88	
7	7	1.93	1.93	2.48	3.31	3.85	13.5 (3.5-16.0)	3.48 (0.7-4.4)	3.88	
7	7	1.78	1.78	2.29	3.06	4.59	13.5 (3.5-16.0)	3.47 (0.7-4.4)	3.89	
7	7	1.60	1.60	2.06	2.75	5.49	13.5 (3.5-16.0)	3.45 (0.7-4.4)	3.91	
7	7	1.85	1.85	2.38	3.71	3.71	13.5 (3.5-16.0)	3.47 (0.7-4.4)	3.89	
7	7	1.55	1.55	2.21	3.44	4.41	13.5 (3.5-16.0)	3.46 (0.7-4.4)	3.90	
7	7	1.55	1.55	1.99	3.10	5.31	13.5 (3.5-16.0)	3.44 (0.7-4.4)	3.92	
7	7	1.60	1.60	2.06	4.12	4.12	13.5 (3.5-16.0)	3.45 (0.7-4.4)	3.91	
7	7	1.89	1.89	3.24	3.24	-	13.5 (3.5-16.0)	3.48 (0.7-4.4)	3.88	
7	7	1.82	1.82	3.12	3.12	3.62	13.5 (3.5-16.0)	3.47 (0.7-4.4)	3.89	
7	7	1.69	1.69	2.89	2.89	4.34	13.5 (3.5-16.0)	3.46 (0.7-4.4)	3.90	
7	7	1.52	1.52	2.61	2.61	5.24	13.5 (3.5-16.0)	3.44 (0.7-4.4)	3.92	
7	7	1.75	1.75	3.00	3.50	3.50	13.5 (3.5-16.0)	3.46 (0.7-4.4)	3.90	
7	7	1.63	1.63	2.79	3.26	4.19	13.5 (3.5-16.0)	3.45 (0.7-4.4)	3.91	
7	7	1.52	1.52	2.62	3.92	3.92	13.5 (3.5-16.0)	3.44 (0.7-4.4)	3.92	
7	7	1.68	1.68	3.38	3.38	-	13.5 (3.5-16.0)	3.46 (0.7-4.4)	3.90	
7	7	1.58	1.58	3.15	3.15	4.04	13.5 (3.5-16.0)	3.45 (0.7-4.4)	3.91	
7	7	2.18	2.18	2.78	2.78	-	13.3 (3.5-15.6)	3.44 (0.7-4.30)	3.87	
7	7	2.05	2.64	2.64	2.64	3.53	13.5 (3.5-16.0)	3.49 (0.7-4.4)	3.87	
7	7	1.97	2.53	2.53	2.53	3.94	13.5 (3.5-16.0)	3.48 (0.7-4.4)	3.88	
7	7	1.82	2.34	2.34	2.34	4.66	13.5 (3.5-16.0)	3.47 (0.7-4.4)	3.89	
7	7	1.63	2.09	2.09	2.09	5.60	13.5 (3.5-16.0)	3.45 (0.7-4.4)	3.91	
7	7	1.92	2.48	2.48	3.31	3.31	13.5 (3.5-16.0)	3.48 (0.7-4.4)	3.88	
7	7	1.72	2.38	2.38	3.18	3.71	13.5 (3.5-16.0)	3.47 (0.7-4.4)	3.89	
7	7	1.72	2.21	2.21	2.95	4.41	13.5 (3.5-16.0)	3.46 (0.7-4.4)	3.90	
7	7	1.55	1.99	1.99	2.66	5.31	13.5 (3.5-16.0)	3.44 (0.7-4.4)	3.92	
7	7	1.78	2.29	2.29	3.57	3.57	13.5 (3.5-16.0)	3.47 (0.7-4.4)	3.89	
7	7	1.66	2.13	2.13	3.32	4.26	13.5 (3.5-16.0)	3.45 (0.7-4.4)	3.91	
7	7	1.56	1.99	1.99	3.98	3.98	13.5 (3.5-16.0)	3.44 (0.7-4.4)	3.92	
7	7	1.82	2.32	3.12	3.12	3.12	13.5 (3.5-16.0)	3.47 (0.7-4.4)	3.89	
7	7	1.75	2.25	3.00	3.00	3.50	13.5 (3.5-16.0)	3.46 (0.7-4.4)	3.90	
7	7	1.63	2.09	2.79	2.79	4.20	13.5 (3.5-16.0)	3.45 (0.7-4.4)	3.91	
7	7	1.69	2.17	2.88	3.38	3.38	13.5 (3.5-16.0)	3.46 (0.7-4.4)	3.90	
7	7	1.58	2.03	2.70	3.15	4.04	13.5 (3.5-16.0)	3.45 (0.7-4.4)	3.91	
7	7	1.63	2.09	3.26	3.26	-	13.5 (3.5-16.0)	3.45 (0.7-4.4)	3.91	
7	7	1.52	1.96	3.05	3.05	3.92	13.5 (3.5-16.0)	3.44 (0.7-4.4)	3.92	
7	7	1.70	2.95	2.95	2.95	2.95	13.5 (3.5-16.0)	3.46 (0.7-4.4)	3.90	
7	7	1.66	2.84	2.84	2.84	3.32	13.5 (3.5-16.0)	3.45 (0.7-4.4)	3.91	
7	7	1.55	2.66	2.66	2.66	3.97	13.5 (3.5-16.0)	3.44 (0.7-4.4)	3.92	
7	7	1.60	2.75	2.75	3.20	3.20	13.5 (3.5-16.0)	3.45 (0.7-4.4)	3.91	
7	7	1.55	2.65	3.10	3.10	3.10	13.5 (3.5-16.0)	3.44 (0.7-4.4)	3.92	
9	9	2.70	2.70	2.70	2.70	2.70	13.5 (3.5-16.0)	3.49 (0.7-4.4)	3.87	
9	9	2.53	2.53	2.53	2.53	2.53	13.5 (3.5-16.0)	3.48 (0.7-4.4)	3.88	
9	9	2.43	2.43	2.43	2.43	3.78	13.5 (3.5-16.0)	3.48 (0.7-4.4)	3.88	
9	9	2.25	2.25	2.25	2.25	4.50	13.5 (3.5-16.0)	3.46 (0.7-4.4)	3.90	
9	9	2.03	2.03	2.03	2.03	5.38	13.5 (3.5-16.0)	3.45 (0.7-4.4)	3.91	
9	9	2.38	2.38	2.38	3.18	3.18	13.5 (3.5-16.0)	3.47 (0.7-4.4)	3.89	
9	9	2.29	2.29	2.29	3.06	3.57	13.5 (3.5-16.0)	3.47 (0.7-4.4)	3.89	
9	9	2.13	2.13	2.13	2.84	4.27	13.5 (3.5-16.0)	3.45 (0.7-4.4)	3.91	
9	9	2.21	2.21	2.21	3.44	3.44	13.5 (3.5-16.0)	3.46 (0.7-4.4)	3.90	
9	9	2.06	2.06	2.06	3.20	4.12	13.5 (3.5-16.0)	3.45 (0.7-4.4)	3.91	
9	9	2.25	2.25	3.00	3.00	3.00	13.5 (3.5-16.0)	3.46 (0.7-4.4)	3.90	
9	9	2.17	2.17	2.89	2.89	3.38	13.5 (3.5-16.0)	3.46 (0.7-4.4)	3.90	
9	9	2.03	2.03	2.70	2.70	4.04	13.5 (3.5-16.0)	3.45 (0.7-4.4)	3.91	
9	9	2.09	2.09	2.80	3.26	3.26	13.5 (3.5-16.0)	3.45 (0.7-4.4)	3.91	
9	9	1.96	1.96	2.61	3.05	3.92	13.5 (3.5-16.0)	3.44 (0.7-4.4)	3.92	
9	9	2.03	2.03	3.15	3.15	3.15	13.5 (3.5-16.0)	3.45 (0.7-4.4)	3.91	
9	9	2.14	2.14	2.84	2.84	2.84	13.5 (3.5-16.0)	3.45 (0.7-4.4)	3.91	
9	9	2.06	2.06	2.75	2.75	3.19	13.5 (3.5-16.0)	3.45 (0.7-4.4)	3.91	
9	9	1.98	1.98	2.66	3.10	3.10	13.5 (3.5-16.0)	3.44 (0.7-4.4)	3.92	
12	12	2.70	2.70	2.70	2.70	2.70	13.5 (3.5-16.0)	3.45 (0.7-4.4)	3.91	
12	12	2.61	2.61	2.61	2.61	3.06	13.5 (3.5-16.0)	3.44 (0.7-4.4)	3.92	

Notes: *7: 7000 Btu/h/9: 9000 Btu/h/12: 12000 Btu/h/14: 14000 Btu/h/18: 18000 Btu/h/24: 24000 Btu/h models
 •The above specifications apply when connected with a wall-mounted unit.
 •2 or more indoor units should be connected.
 •Heating capacity is determined based on 20°CDB (indoor temperature) and 7°CDB/6°CWB (outdoor temperature).
 •Pipe Length: 5 m, Height difference: 0 m (Outdoor unit to Indoor unit)
 •Total capacity of indoor units connected must be between 7.5 kW and 15.5 kW.

6-unit Multi-split heating

ADHG45LBLA6	Combination of Indoor Units		Heating Operation						Input Power (Min. - Max.)	COP
			Heating Capacity							
			Unit 1	Unit 2	Unit 3	Unit 4	Unit 5	Unit 6		
			kW	kW	kW	kW	kW	kW	kW	kW
4-unit connection	7	7	2.20	2.20	2					

Feature Summary

Type	Wall-mounted type				Wall-mounted type			
	Designer Series		Standard Series		Standard Series		Designer Series	
Series	Designer Series		Standard Series		Standard Series		Designer Series	
Model name								
Refrigerant	ASHH07/09/12/14KGTG ASHG07/09/12/14KGTE		ASHG07/09/12/14KETF, ASHG07/09/12/14KETF-B, ASHG07/09/12/14KETE, ASHG07/09/12/14KETE-B		ASHH07/09/12/14KMCG ASHG07/09/12/14KMCE		ASHH05/07/09/12KNCA ASHG18/22/24KMTE	
Refrigerant								
Energy-saving Features	 Save Occupancy sensor	●						
	 Economy operation	●	●	●	●	●	●	●
	 Setting temperature range limitation	○	○	○		○	○	○
	 Set temperature auto return	○	○	○		○	○	○
Features for Comfort	 Power diffuser						●	●
	 Powerful operation	●	●	●	●	●		
	 10°C Heat	●	●	●	●	●	●	●
	 Outdoor unit low noise operation	●	●	●	●	●		
	 Auto changeover	●	●	●	●	●	●	●
	 UP/DOWN swing louver	●	●	●	●	●	●	●
	 Double swing automatic				●	●		●
	 Automatic fan speed	●	●	●	●	●	●	●
	 Auto restart	●	●	●	●	●	●	●
	 Connectable fresh air duct							
	 Fresh air intake							
	 Connectable distributing duct							
	Convenience Features	 Auto-off timer	○	○	○	●	○	○
 Sleep timer		●	●	●	●	●	●	●
 Program timer		●	●	●	●	●	●	●
 Weekly timer		●	●	○	○	●	●	
 Weekly & Temperature setback timer		○	○	○		○	○	○
 Filter sign		●	●	●	●	●	●	●
 External error output		○	○	○		○	○	○
 External ON/OFF input		○	○	○		○	○	○
 Wireless LAN control		● (KGTG), ○ (KGTE)	● (KETF, KETF-B), ○ (KETE, KETE-B)	● (KMCG), ○ (KMCE)	●	○	○	○
Clean Features	 Ion deodorization filter	●	●	●		●	●	●
	 Apple-catechin filter	●	●	●		●	●	●
	 Long-life filter							
	 Washable panel	●	●	●	●	●	●	●
	 Silver Ion Filter	○	○	○	○	○	○	○
Installation / Support	 Automatic airflow adjustment							
	 Drain pump as standard							
	 Blue fin				●			●
	 Refrigerant cycle monitor							● (30)

○ : Optional function

Feature Summary

Type	Cassette			Duct			Duct			Floor	Floor/Ceiling	Ceiling		
	Compact 4-way Flow Grid type Series	Compact 4-way Flow Series	4-way Flow Series	Mini (With drain pump)	Slim (With drain pump)	Slim (With drain pump)	Medium Static Pressure							
Series														
Model name	AUXG 07/09/12/ 14/18/22/24 KVLA	AUHG07/09LVLA, AUHG12/14/18LVLB, AUHG22/24LVLA	AUHG30/36LRLE, AUHG36/45LRLA	ARXG 07/09/12/14/18 KSLAP	ARHG 07/09/12/14/18 LSLAP	ARXG 07/09/12/14/18 KLLAP	ARHG07/09LLTA, ARHG12/14/18LLTB	ARXH 12/14/18/22 KMTAP	ARXG22KMLB, ARXG24KMLA	ARHG 22/24/36/45 LMLA, ARHG 30/36LMLE	AGHG09/12/14KVCA AGHG09/12/14LVCA	ABHG14/22/24LVTA, ABHG18LVTB	ABHG18/22KRTA	ABHG30/36LRTE, ABHG36/45LRTA
Refrigerant														
Energy-saving Features	Save Occupancy sensor													
	Economy operation	●	●	●	●	●	●	○	●	●	●	●	●	●
	Setting temperature range limitation	○	○	○	●	●	○	○	○	○	○	○	●	○
	Set temperature auto return	●	○	○	●	●	●	○	○	●	○	○	●	○
Features for Comfort	Power diffuser													
	Powerful operation										●			
	10°C Heat	●	●	○	○	○	○	○	○	○	●	●	○	●
	Outdoor unit low noise operation										●		○	○
	Auto changeover	●	●	●	●	●	●	●	●	●	●	●	●	●
	UP/DOWN swing louver	●	●	●	○	○	○	○			●	●	●	
	Double swing automatic												●	●
	Automatic fan speed	●	●	●	●	●	●	●	●	●	●	●	●	●
	Auto restart	●	●	●	●	●	●	●	●	●	●	●	●	●
	Connectable fresh air duct		○	●					●	●	●		●	●
	Fresh air intake	○	○	○			○	○	○	○			○	○
	Connectable distributing duct										●	●		
	Convenience Features	Auto-off timer	●	○	○	●	●	●	○	●	●	○	○	●
Sleep timer		●	●	○	○	○	○	○	○	○	●	●	○	●
Program timer		●	●	○	○	○	○	○	○	○	●	●	○	●
Weekly timer		●			●	●	●		○	●			●	
Weekly & Temperature setback timer		○	○	●			●	●	●	●		○	○	○
Filter sign		●	●	●	●	●	●	●	●	●	●	●	●	●
External error output					○	○					○		○	
External ON/OFF input		●	○	○	●	●	●	○	●	●	○	○	○	○
Wireless LAN control		○	○	○	○	○	○	○	○	○	○	○	○	○
Clean Features	Ion deodorization filter										●	●		
	Apple-catechin filter										●	●		
	Long-life filter								○	○	○	●	●	
	Washable panel													
	Silver Ion Filter	○	○	○	○	○	○	○	○	○	○	○		
Installation / Support	Automatic airflow adjustment													
	Drain pump as standard	●	●	●	●	●	●	●	○	○			○	○
	Blue fin			(45/54)									(30/36/45/54)	(45)
	Refrigerant cycle monitor								○					

○ : Optional function

Light Commercial & Commercial, Residential VRF

VRF systems provide air conditioning solutions that meet the requirements of a diverse range of buildings.

VRF systems provide air conditioning solutions for large residences as well as large commercial buildings.

V-002 VRF Series Overview
V-004 VRF Outdoor Units Lineup
V-006 Features

VRF Outdoor Units



VRF J Series Heat Pump for Small-capacity type

V-020 VRF J-VS
V-026 VRF J-IVS
V-030 VRF J-IV
V-034 VRF J-IVL



VRF V Series Heat Recovery Modular type

V-040 VRF VR-IV

Heat Pump Modular type

V-050 VRF V-IV

VRF INDOOR UNITS

V-058 VRF Indoor Unit Lineup for J-VS
V-066 VRF Indoor Unit Lineup for J-IVS, J-IV, J-IVL, VR-IV, V-IV



VRF

Light Commercial
& Commercial,
Residential



FUJITSU GENERAL (Euro) GmbH participates in the ECP program for VRF. Check ongoing validity of certificate: www.eurovent-certification.com

FUJITSU GENERAL LIMITED

VRF Series Overview

Recommended VRF products for various buildings



NEW VRF **J-VS**



Maximum 6 HP Heat Pump

This product uses R32, a new environmentally friendly refrigerant. With TOP-class energy efficiency and compact design, it can be installed in a limited and narrow space without being conspicuous. Indoor unit connectable up to 130%.

- Sustainable(R32)
- Saving CO2
- Small Body
- Situational Piping Design
- Sightliness installation



Page V-020

VRF **VR-IV**



Maximum 48 HP Heat Recovery

Smart, cutting-edge design Available in a wide range of models from 8 to 48 HP in 2 HP increments with the capacity ratio of indoor units connectable up to 150%.

- Excellent energy saving
- High design flexibility for placement in any building
- Easy installation and maintenance



Page V-040

VRF **J-IVS**



Maximum 6 HP Heat Pump

The 998 mm compact design does not obstruct the view even when installed underneath a waist-high window, ideal for large houses and retail stores. Indoor unit connectable up to 130%.

- Spaces saving and low sound level design
- Flexible system configuration for homes, stores, and small buildings



Page V-026

VRF **V-IV**



Maximum 48 HP Heat Pump

Smart, cutting-edge design Extensive lineup from 8 HP to 48 HP with the capacity ratio of indoor units connectable up to 150%.

- Simultaneous cooling and heating operation using a single refrigerant system
- Annual cooling operation
- Accommodating changes in temperature difference



Page V-050

VRF **J-IV**



Maximum 6 HP Heat Pump

J-IV is connectable with up to 14 indoor units (Indoor unit connectable up to 150%) making it suitable for commercial facilities housing a number of small stores.

- High energy efficiency
- Flexible system configuration for small and midsize buildings



Page V-030

VRF **J-IVL**



Maximum 18 HP Heat Pump

J-IVL is an outdoor unit with a slim design. Its flexibility in installation makes it ideal for midsize office buildings and hotels. With the newly added 14/16/18 HP models, up to 42 indoor units* are connectable, making them ideal for hotels and educational facilities with many rooms.

- Slim Outdoor Unit
- Small room application
- Class-leading Low Operating Sound



Page V-034

Design Simulator

When installing air conditioning equipment in each room of a building, it is necessary to select an indoor unit suitable for the heat load in the room and derive an outdoor unit that can cover the capacity of all indoor units. In addition, remote controls and converters are selected according to how the customer will manage the air conditioner, and in some cases, a design combined with options may be required to comply with established standards. The "Design Simulator" can be used to facilitate the selection of such complex equipment and the output of system drawings and estimates. (Software for PC)

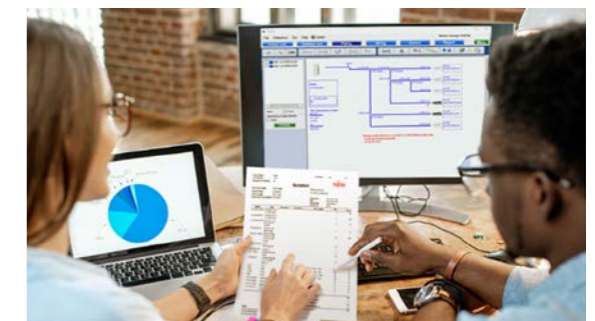

For more information



VRF Outdoor Units Lineup

Capacity (kW)		Refrigerant	12.1	14.0	15.1-15.5	22.4	28.0	33.5	40.0	45.0	50.0-50.4	55.9	61.5	67.0	73.5	78.5	85.0	90.0	95.0	100.5	107.0	112.0	118.5	123.5	130.0	135.0	
HP			4	5	6	8	10	12	14	16	18	20	22	24	26	28	30	32	34	36	38	40	42	44	46	48	
NEW	J-VS Series																										
			AJH040 KCTAH	AJH045 KCTAH	AJH054 KCTAH																						
	J-IVS Series																										
	J-IVS Series		AJH040 LCLDH	AJH045 LCLDH	AJH054 LCLDH																						
	J-IV Series																										
	J-IV Series		AJH040 LBLDH, AJH040 LELDH	AJH045 LBLDH, AJH045 LELDH	AJH054 LBLDH, AJH054 LELDH																						
	J-IVL Series																										
	J-IVL Series					AJH072 LELDH	AJH090 LELDH	AJH108 LELDH	AJH126 LELDH	AJH144 LELDH	AJH162 LELDH																
VR-IV Series Heat Recovery	Space Saving																										
	Set Model					AJH072 GALDH	AJH090 GALDH	AJH108 GALDH	AJH126 GALDH	AJH144 GALDH	AJH162 GALDH	AJH180 GALDH	AJH198 GALDH	AJH216 GALDH	AJH234 GALDH	AJH252 GALDH	AJH270 GALDH	AJH288 GALDH	AJH306 GALDH	AJH324 GALDH	AJH342 GALDH	AJH360 GALDH	AJH378 GALDH	AJH396 GALDH	AJH414 GALDH	AJH432 GALDH	
VR-IV Series Heat Recovery	Energy Efficiency																										
	Set Model								AJH144 GALDHH			AJH198 GALDHH		AJH216 GALDHH	AJH234 GALDHH	AJH252 GALDHH	AJH270 GALDHH	AJH288 GALDHH	AJH306 GALDHH	AJH324 GALDHH	AJH342 GALDHH	AJH360 GALDHH	AJH378 GALDHH	AJH396 GALDHH			
V-IV Series Heat Pump	Space Saving																										
	Set Model					AJH072 LALDH	AJH090 LALDH	AJH108 LALDH	AJH126 LALDH	AJH144 LALDH	AJH162 LALDH	AJH180 LALDH	AJH198 LALDH	AJH216 LALDH	AJH234 LALDH	AJH252 LALDH	AJH270 LALDH	AJH288 LALDH	AJH306 LALDH	AJH324 LALDH	AJH342 LALDH	AJH360 LALDH	AJH378 LALDH	AJH396 LALDH	AJH414 LALDH	AJH432 LALDH	
	Energy Efficiency																										
	Set Model								AJH144 LALDHH		AJH180 LALDHH		AJH216 LALDHH	AJH234 LALDHH	AJH252 LALDHH	AJH270 LALDHH	AJH288 LALDHH	AJH306 LALDHH	AJH324 LALDHH	AJH342 LALDHH	AJH360 LALDHH	AJH378 LALDHH	AJH396 LALDHH				



Features

High-efficiency

High-efficiency is achieved significantly by the use of a DC twin-rotary compressor, inverter technology, and a large heat exchanger.



DC twin-rotary compressor

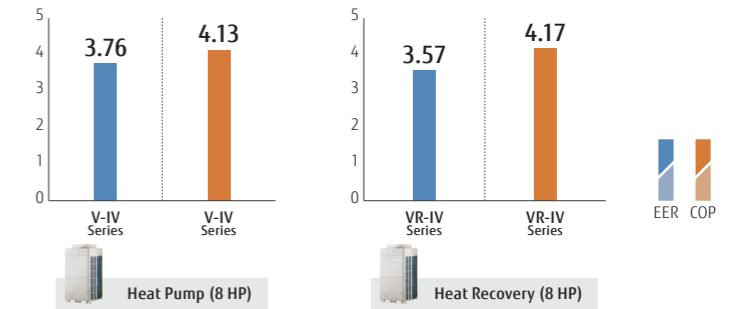

* These specifications are determined by ducted combination.

ALL DC High-efficiency design with top-class SEER/SCOP

All the VRF Series, including the J-IVL Series, have DC technology to achieve high-efficiency operation. This enhances the durability and reliability of the VRF Series.

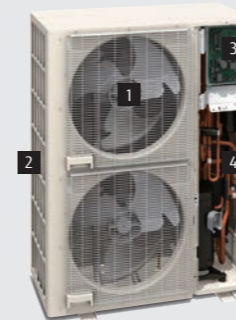

J-IVL Series

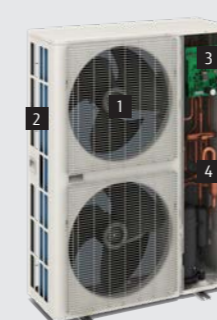

J-IV Series

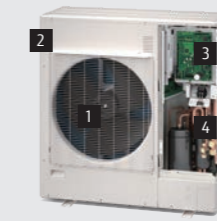

J-IVS Series

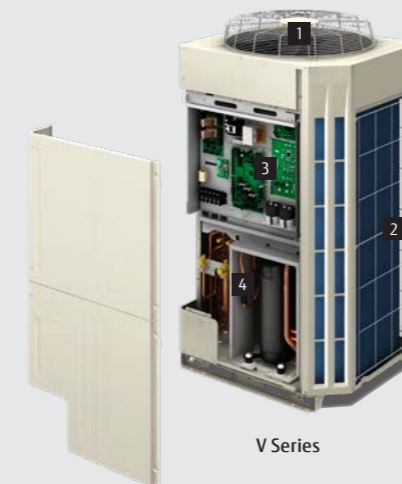

V Series



1 DC fan motor



3 DC inverter control

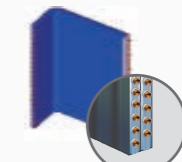

2 Large heat exchanger



4 Subcooling heat exchanger



1 3-phase DC fan motor



3 Sine-wave DC inverter control



2 Large heat exchanger



4 Subcooling heat exchanger

Efficient control of operation

Setting temperature range limitation

Sets the minimum and maximum limits on room temperature to establish an optimum balance between energy-saving performance and a comfortable environment.

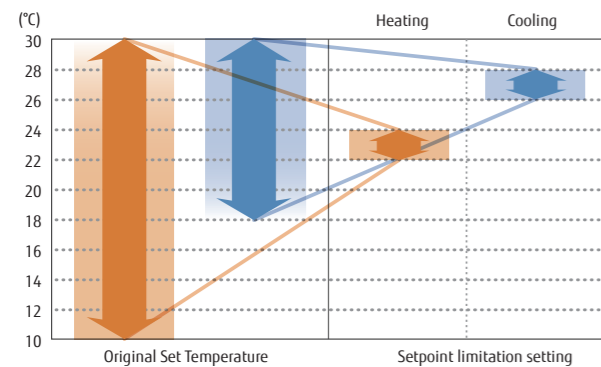

Auto-off timer

The wired remote controller is equipped with an auto-off timer function that automatically stops operation after a fixed period of time has elapsed from the start of operation to avoid wasting energy. The function also allows you to set the interval for stopping operations.

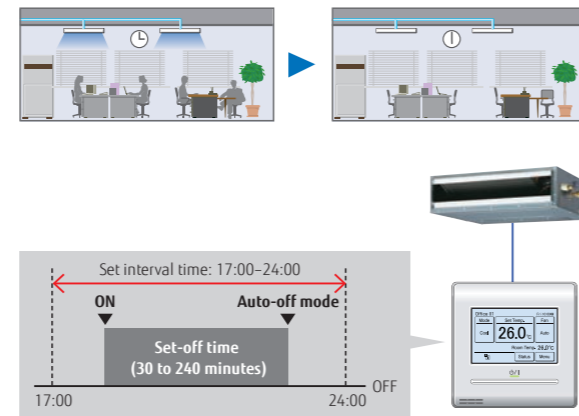

Energy-saving management

A variety of energy-saving operations can be set and managed depending on the season, climate, and time period. Excellent energy-saving operation using the system controller.

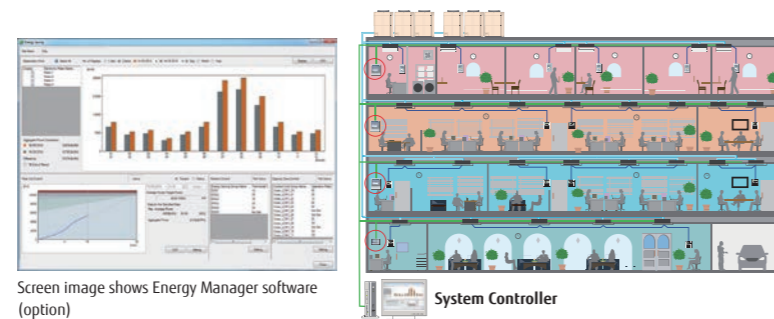

Capacity-saving mode

Operation capacity can be reduced in 5 steps from the rated capacity. This mode cuts down on peak power consumption and eases the maximum load on the unit.

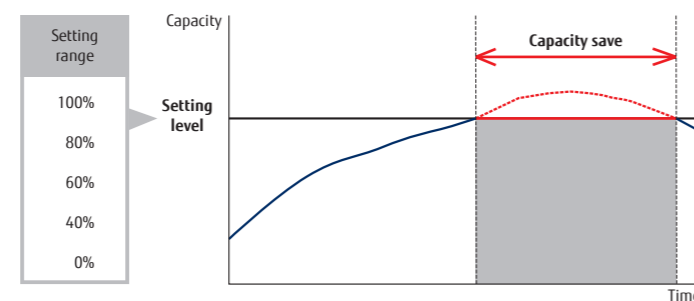

Intelligent refrigerant control

Fujitsu General is proposing outdoor units equipped with refrigerant control function. The refrigerant control operates with subtle control corresponding to the heat load of the room and offers a more comfortable environment. The refrigerant control can also provide increased energy savings.

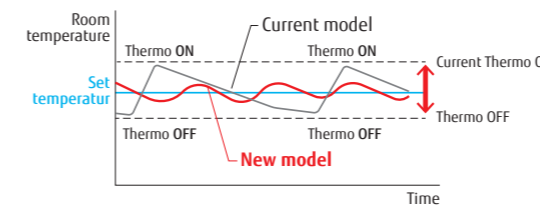

Current refrigerant control

Thermostat-ON/OFF occurs frequently. → Frequent changes in room temperature interfere with comfort. The compressor starts and stops repeatedly, wasting energy.

New refrigerant control

The thermostat is turned on and off less frequently than under current control to maintain the room temperature at the target temperature. Compared to current control, the compressor will run longer, thus saving energy.

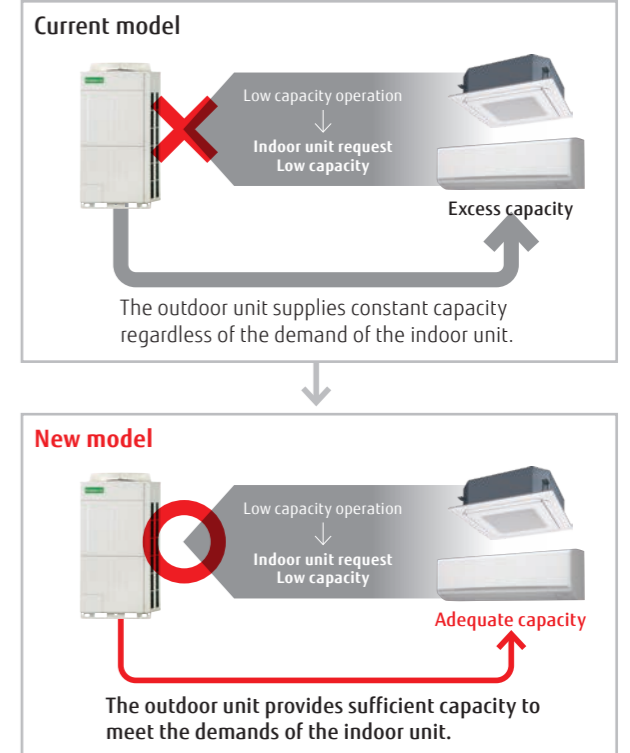

* The improvements due to the control and the actual sine wave vary depending on the combination of the indoor unit and system operating conditions.

More Comfort



Auto changeover

In Auto setting, the air conditioner switches between cooling and heating modes automatically according to the set temperature and the room temperature.

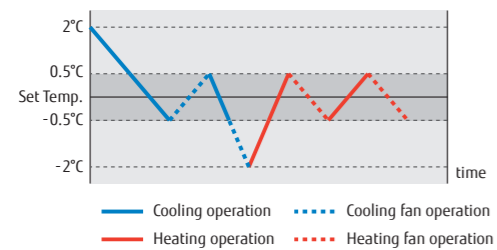

Auto changeover settings enable the indoor unit to easily switch between cooling and heating regardless of the operating mode of other indoor units. These settings can be made using a wired remote controller for a specific indoor unit. Provides a comfortable environment all year round.

Automatic cooling/heating operation for each room is possible

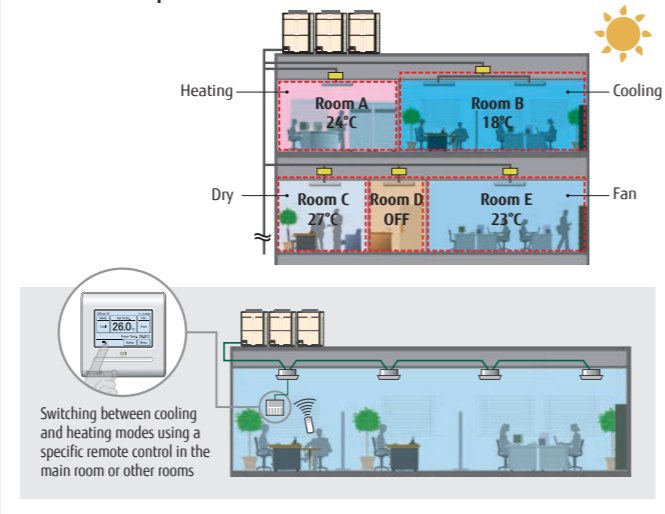

Precise control of refrigerant flow

The combination of DC inverter control and individual control of electronic expansion valves of an indoor unit enables precise and smooth control of the refrigerant flow. This means the room temperature can be set in increments of 0.5°C.

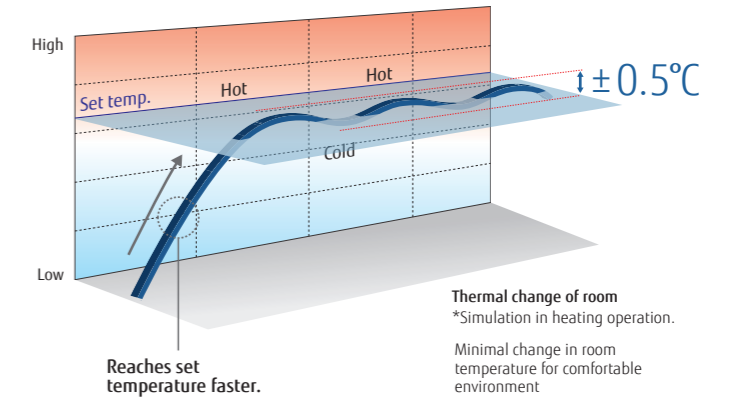

Quiet operation

Quiet operation

Two low noise modes can be switched over automatically between one in which low noise is prioritized over performance, and the other in which performance is prioritized over low noise, depending on the room temperature and outdoor temperature. This feature can be controlled by external input from the outdoor unit or a system controller.

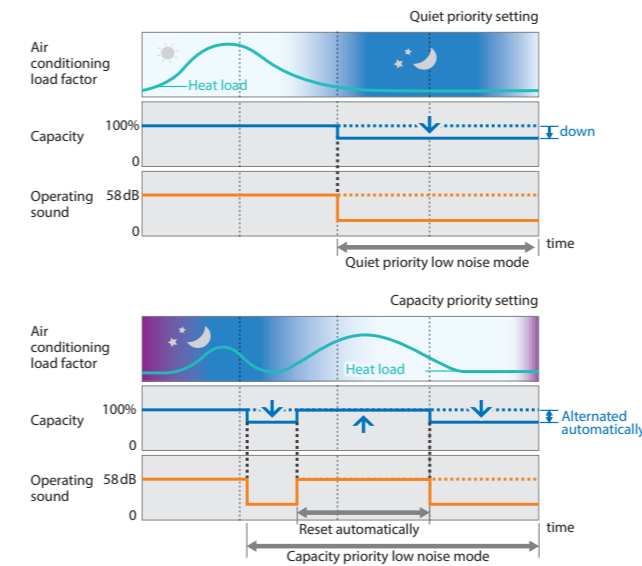

Non-stop oil recovery operation

A comfortable room condition is maintained during oil recovery mode because the product continues to operate without stopping the cooling or heating operation.

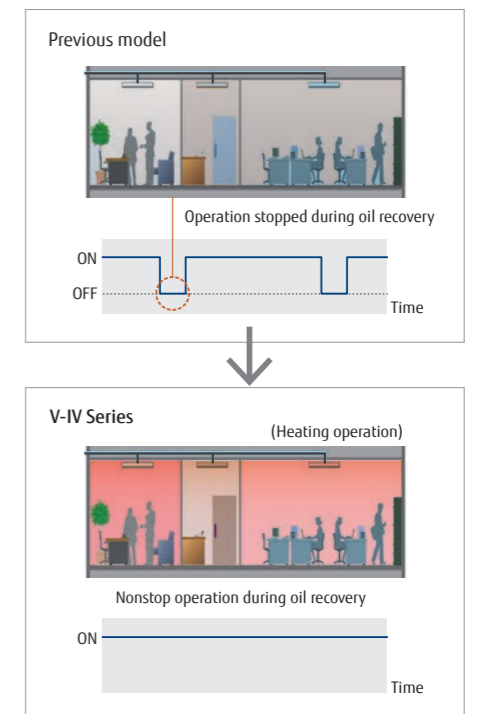

NEW Switching room temperature sensing position for improved heating comfort (Option)

The optional remote sensor kit (UTY-XSZXZ1) can be connected to the indoor unit to improve comfort by installing the unit at a height appropriate for the living environment.

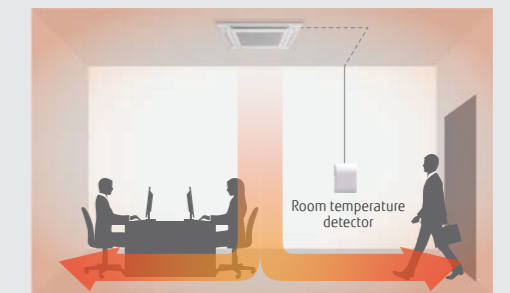

High Reliability

Outdoor unit rotation

The compressor starting order is rotated to equalize the cumulative running time of each unit.

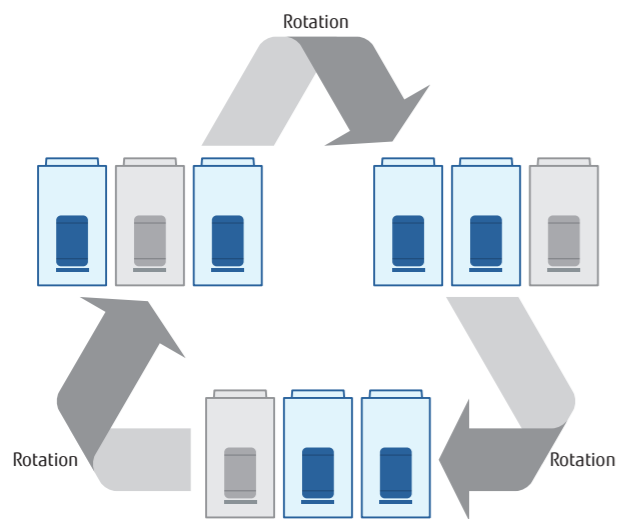

The start and stop timings are alternated among connected compressors.

Backup operation

If one compressor fails, the other compressors will initiate backup operation*.

Note: Backup operation may not be possible depending on the cause of failure.

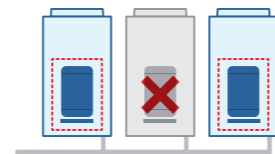

Advanced refrigerant control

Compressor control logic controls the inverter speed to balance the mass airflow rate of refrigerant in each outdoor unit.

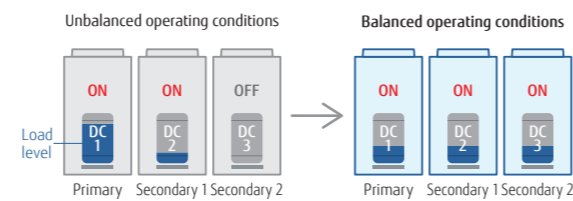

Protection against liquid flowback

The use of a large accumulator means that refrigerant that has not been completely vaporized stays inside the accumulator to ensure no liquid refrigerant is fed into the compressor.

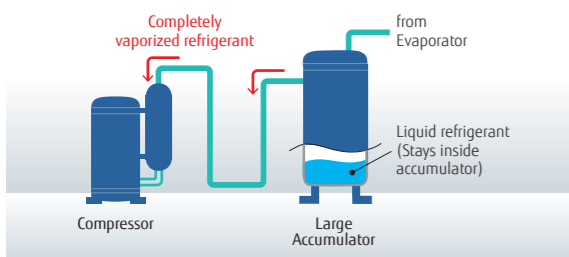

Blue fin heat exchanger

The anti-corrosion blue fin treatment is applied to the heat exchanger of the outdoor unit.

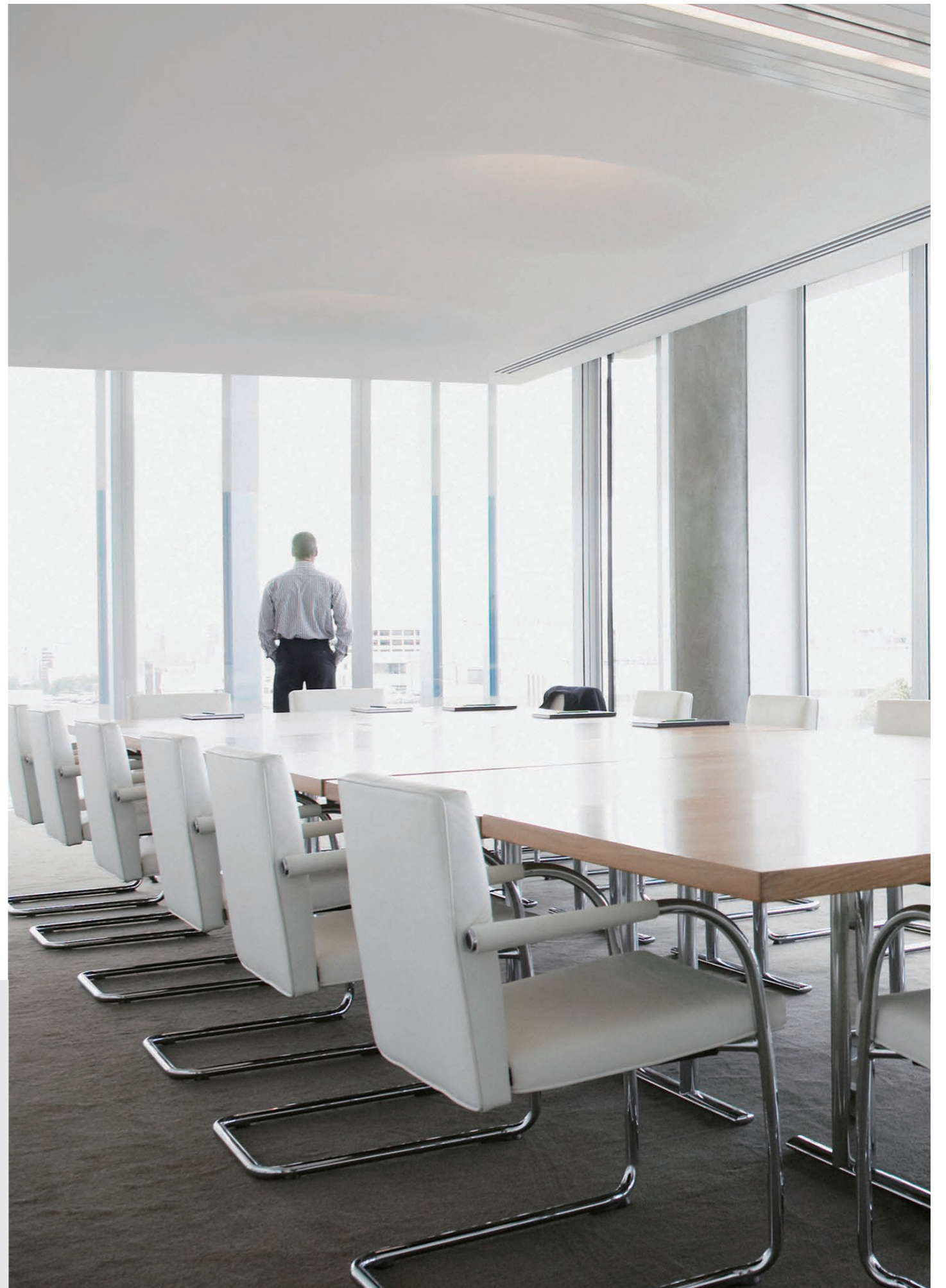
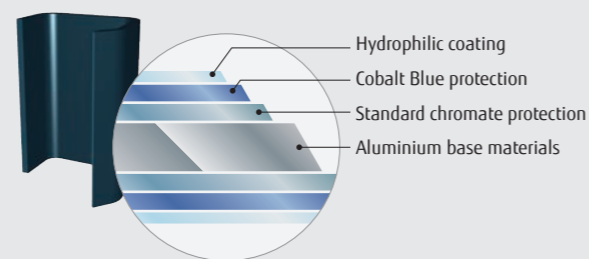

Design Flexibility

Class-leading compact design

An industry-leading compact outdoor unit with optimal airflow pattern design. (Up to 18 HP)



Long pipe design

Pipe design suitable for long and narrow office buildings with elevation differences and low-rise stores with long distances (VRF J-IVL Series)

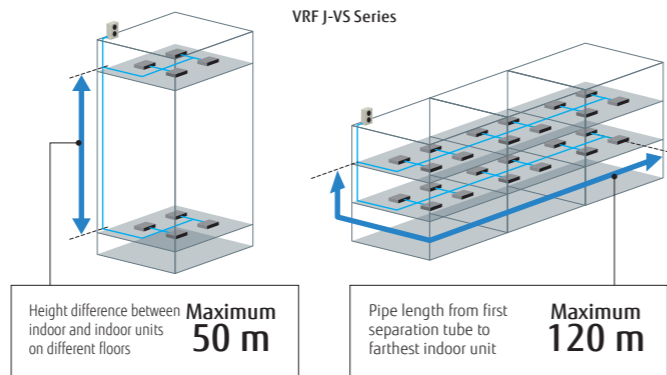

Max. allowable overall pipe length: 1,000 m

The class-leading pipe length of 1,000 m increases flexibility of installation in a wide variety of buildings.

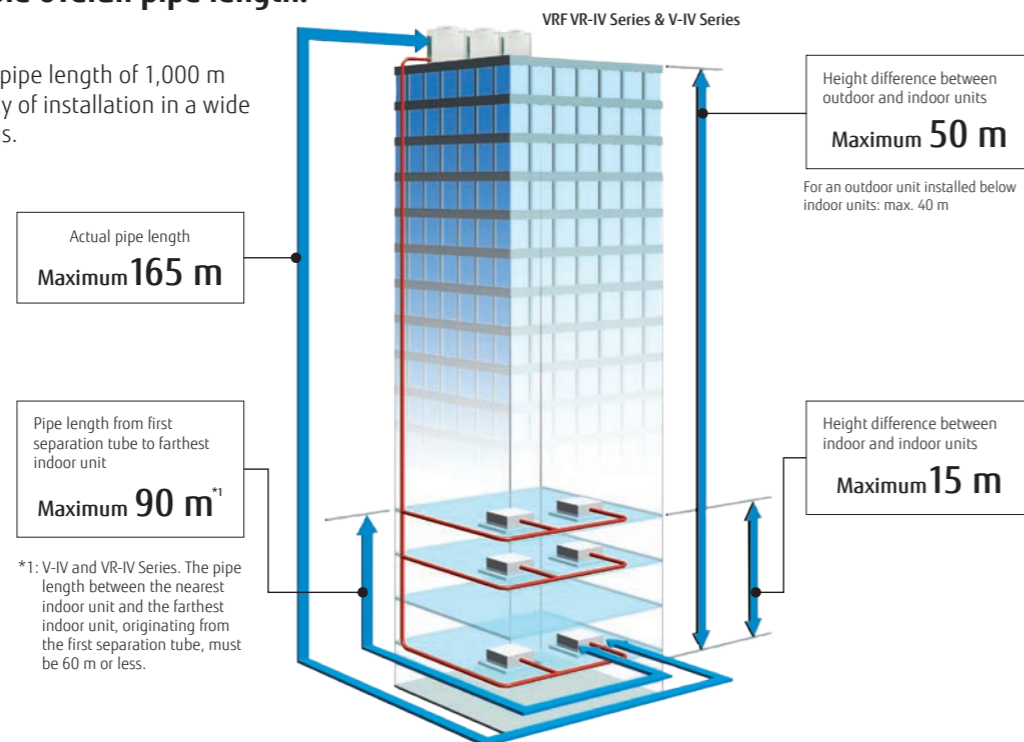

*1: V-IV and VR-IV Series. The pipe length between the nearest indoor unit and the farthest indoor unit, originating from the first separation tube, must be 60 m or less.

High-capacity connection

Series	Connectable indoor unit capacity range	Connectable indoor units
VRF J-VS Series Heat pump type	50% to 130%	up to 13 ^{*5}
VRF J-IVS Series Heat pump type	50% to 130%	up to 13 ^{*5}
VRF J-IV Series Heat pump type	50% to 150%	up to 14 ^{*5}
VRF J-IVL Series 14/16/18 HP Heat pump type	50% to 150%	up to 42 ^{*3}
VRF J-IVL Series 8/10/12 HP Heat pump type	50% to 150%	up to 30 ^{*4}
VRF VR-IV Series Heat Recovery Modular type	25% ^{*5} to 150%	up to 64
VRF V-IV Series Heat Pump Modular type	50% to 150% ^{*2}	up to 64

*2: The maximum capacity of the combination that includes the 18-HP outdoor unit is below 150%.
 *3: J-IVL Series 18-HP model only.
 *4: J-IVL Series 12-HP model only.
 *5: 6-HP model only.

Designed for low refrigerant charge

The optimal design of the indoor and outdoor units reduces the amount of refrigerant required and can be easily installed in a room as small as 15 m².



Various optional parts

- Fresh air intake kit to bring in fresh air
- Comfortable temperature control with a remote sensor
- DX kit links ventilation equipment and air handling units.

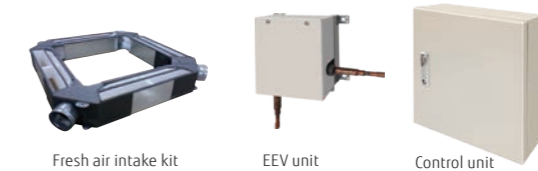

Low ambient operation

Our refrigeration cycle technology enables cooling operation even at -15°C.



Wide operating temperature range

All outdoor units have a wide operating temperature range and can operate in extreme temperature conditions.

*6: When multiple outdoor units are connected, their operating temperature range is from -5°C to 46°C in cooling.
 *7: The operating range is -15°C to 46°C only for systems with all indoor units rated at 5.6 kW or more.

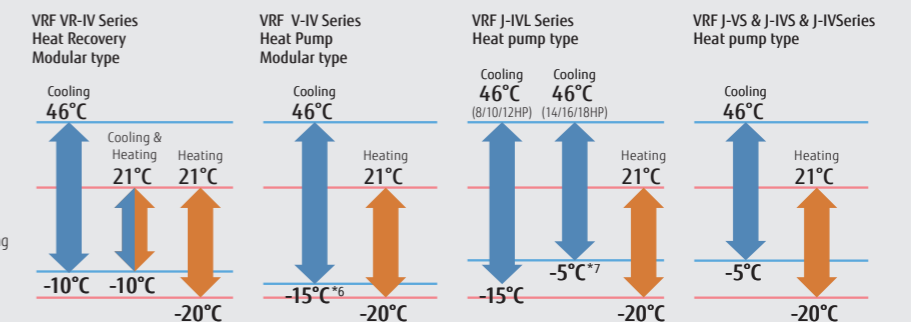

Easy Installation



Easily transported

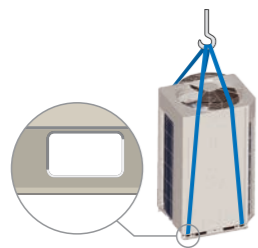

A lifting strap can be hooked onto an outdoor unit
Design of outdoor unit allows for lifting straps to be used

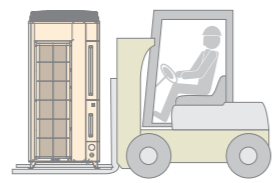

Transportable by forklift
The outdoor unit can be lifted and transported by forklift.

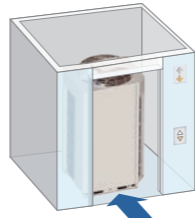

Fits into a small elevator.

Easy access

The removable L-shaped front panel provides more room for installation and service work. Multiple installations can be performed easily and efficiently even in tight spaces.

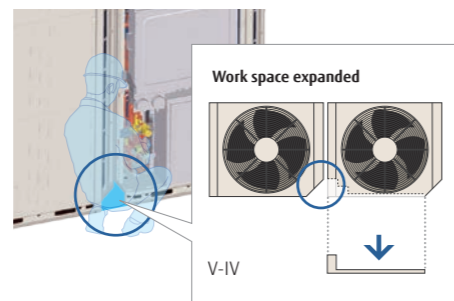

Front access reduces installation intervals

Flexible pipe connection

Piping and wiring can be accessed from the front, left, right, and bottom.

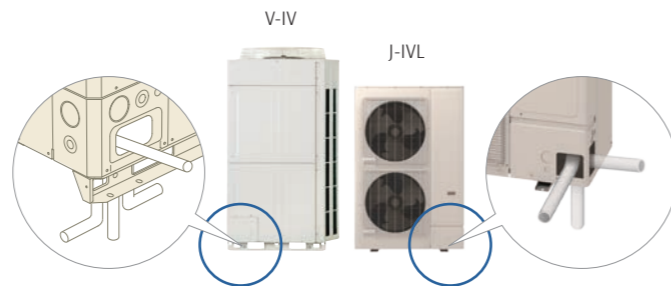

Simplified wiring work

The communication wiring can be installed seamlessly among indoor, outdoor, and RB units, which makes the installation of the wiring system easier.

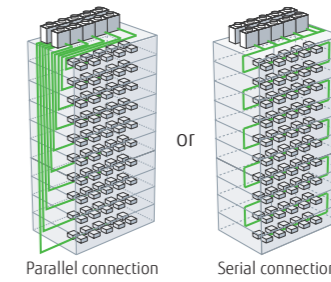

Maximum wiring length: 3,600 m

Note: The automatic address setting is not available on a serially connected multiple refrigerant system.

Vacuum mode function for easy evacuation

The vacuum mode function enables all expansion valves of an indoor unit to be opened fully, allowing for easier evacuation of air inside pipe lines and indoor units.

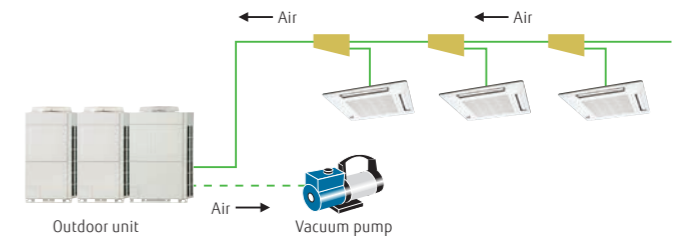

Automatic address setting

Addresses of connected indoor units, RB units, and Signal amplifier can all be set automatically from the PCB in the outdoor unit.

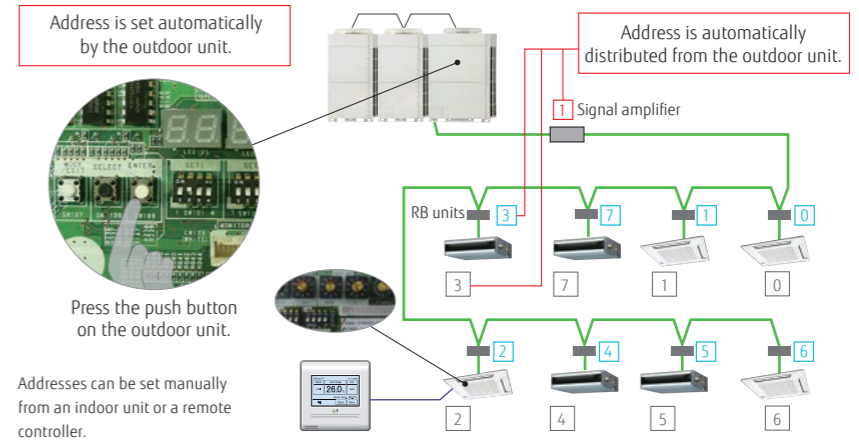

Easy commissioning with Tools

• Service Tool (UTY-ASGXZ1)

The Service Tool checks the refrigerant temperature and pressure, and the operating status of the electronic expansion valves, making it easy to determine if the units are connected properly.

NEW • Central Remote Controller (UTY-DCGGZ3)

After the VRF system has been installed. Conveniently, the "test run" required to verify proper system operation can be performed from a nearby Central RC.



Easy Service and Maintenance

Designed for easy maintenance

A 7-segment indicator lamp panel provides detailed information on the function setting status, refrigerant temperature and pressure, compressor operation time, and other factors, facilitating self-diagnosis for each unit.

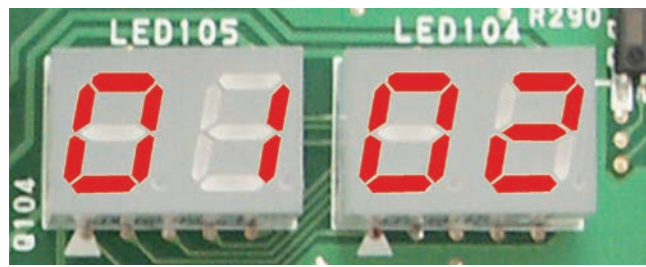

Easy-to-read 7-segment indicator lamp

Shows the following detailed operation and error status without need of any special tools.

Error status can be checked on an outdoor unit's display

- System operation mode
- Discharge temperature and pressure
- Compressor operation status
- Address, type, and number of outdoor unit

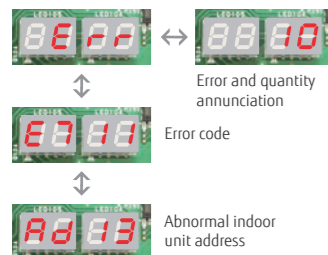

- Error status can easily be checked on an outdoor unit's display.

Movable PCB panel

Enables easier access behind the PCB for maintenance work.

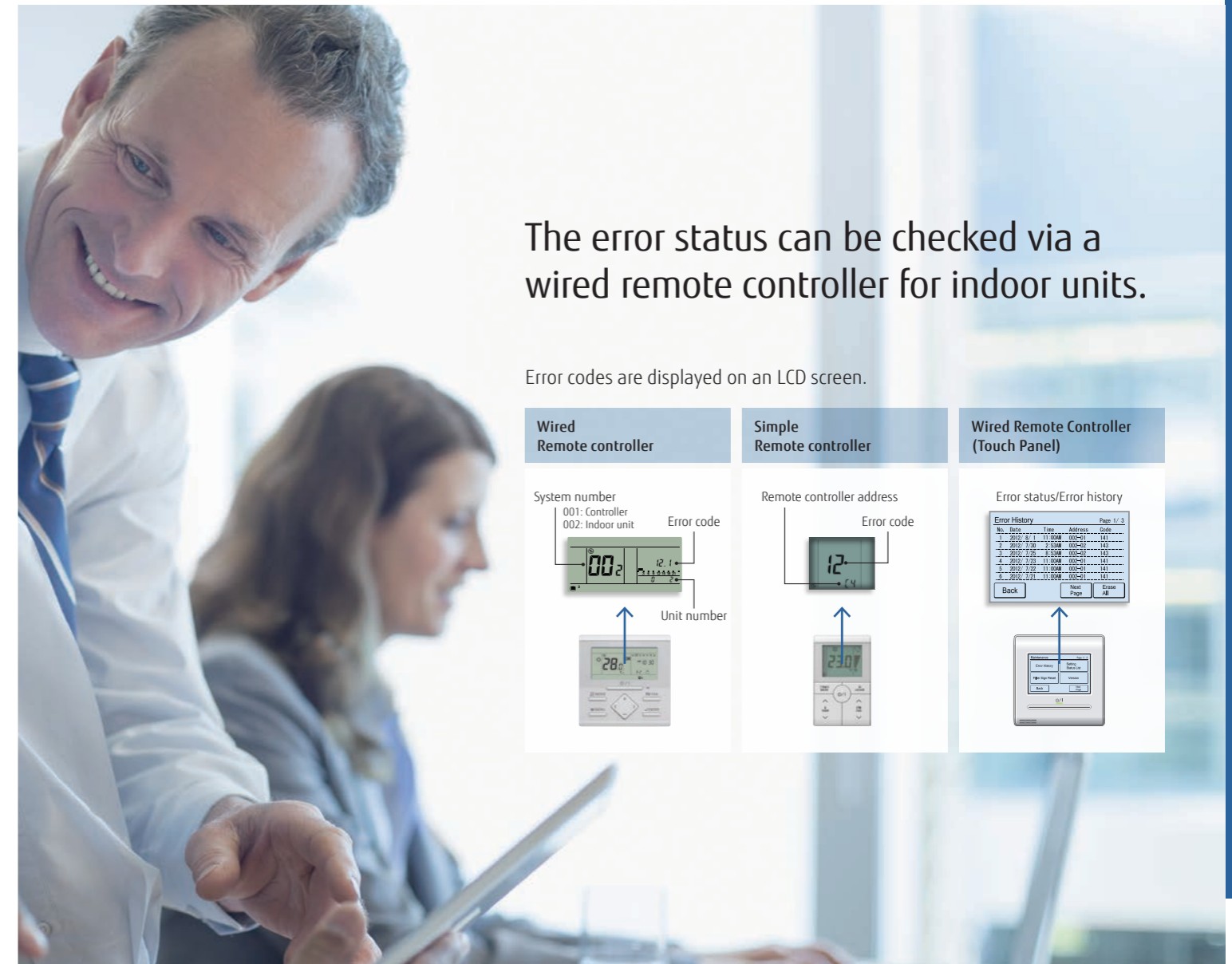
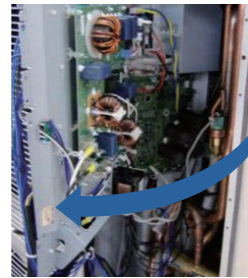

The error status can be checked via a wired remote controller for indoor units.

Error codes are displayed on an LCD screen.

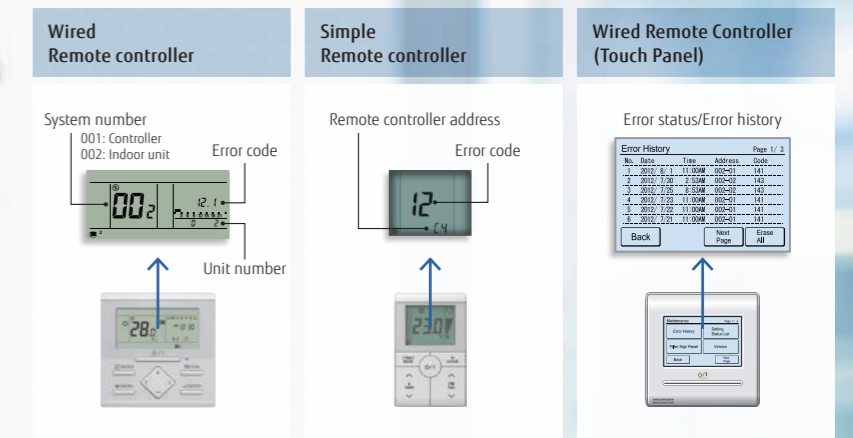

Error diagnosis by Service tool

Connection to Service tool

- A detailed operation status and recent error history can be checked and analyzed using Service tool.
- The last 5 minutes of operation status can be recorded continuously.

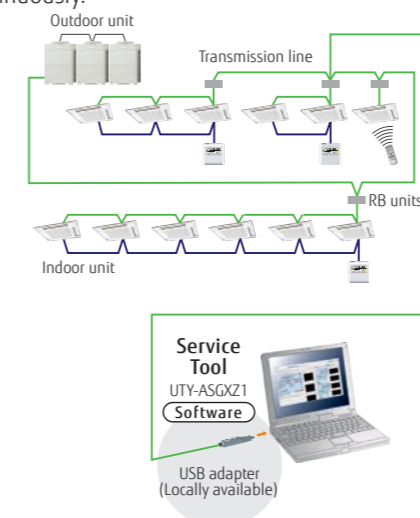

Remote monitoring

The Web Monitoring system enables the monitoring of the system's operation status at any time via the internet to ensure trouble-free operation. The operating VRF network system in the building can be monitored real time over the internet.

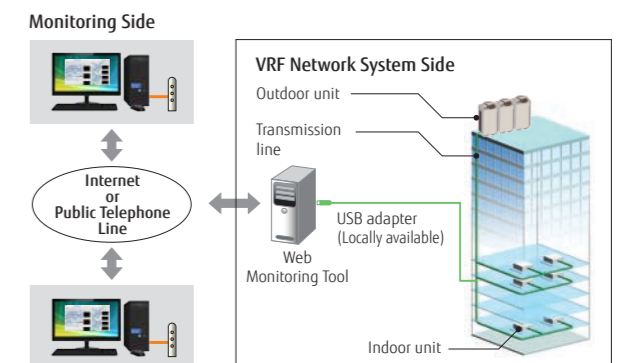



Heat Pump
for Small-capacity type

VRF **J-VS**

System configuration example

- Suitable for air conditioning small and medium-size buildings. One refrigerant system is used for each outdoor unit.
- Multiple indoor units are connected with separation tubes and headers.

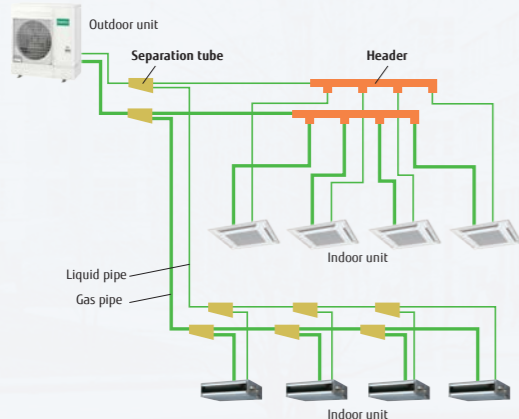

R32 refrigerant with reduced global warming potential

- **Zero** Ozone Depletion Potential (ODP^{*1})
- High environmental properties
- High performance
- Economically efficient

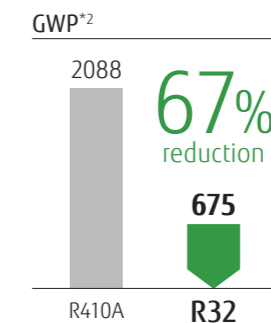

(Reference: IPCC 4th Report)

^{*1} ODP (Ozone Depleting Potential): a relative value that indicates the impact per unit weight of ozone-depleting substances released into the atmosphere when CFC-11 (trichlorofluoromethane, CCl₃F) is fixed at 1.0

^{*2} GWP (Global Warming Potential): a measurement that indicates how much other greenhouse gases are capable of warming the Earth based on carbon dioxide. This is the integrated value of radiant energy given to the Earth (i.e., the estimated impact on global warming) expressed as a ratio to CO₂.

This product uses R32, a new environmentally friendly refrigerant. With TOP-class energy efficiency and compact design, it can be installed in a limited and narrow space without being conspicuous.

for SHOP

for LARGE APARTMENT

for OFFICE

Saving CO₂

Sustainable (R32)

Small Body

"5S" leading to the optimal solution

Situational Piping Design

Sightliness installation



Outdoor unit

Sustainable

European F-Gas Regulation Plan

In light of the UN recommendations, Japanese government targets, and recent social trends, we have set a new long-term target of FY2050 as the target year, and reviewed our medium-

term targets to achieve the long-term target. by resolution of the Board of Directors in August 2023.

2029 Available at J-VS Split AC & HP Over 12 kW: GWP 750 and above prohibited 12 kW or less: GWP 150 and above prohibited	2033 Split AC & HP Over 12 kW: GWP 150 and above prohibited	2035 Split AC & HP HFC use prohibited	2050 an economy with net-zero greenhouse gas emissions.
---	---	--	--

Refrigerant saving design

Refrigerant saving design the compact indoor unit, piping design, and optimization of heat exchanger volume significantly reduce the system refrigerant volume.

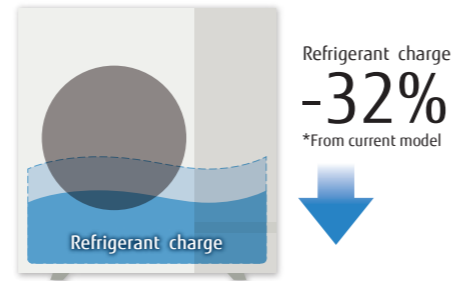

Enhanced disaster safety measures

The system is designed to meet the environmental safety requirements specified in the IEC 603352-40 standard for the use of R32 refrigerant. The environment requiring safety measures is determined by the size of the room in relation to the amount of refrigerant required. For example, if the system is designed for maximum pipe length and the refrigerant charge is 6 kg, safety measures are required for rooms of 15 m2 or less.

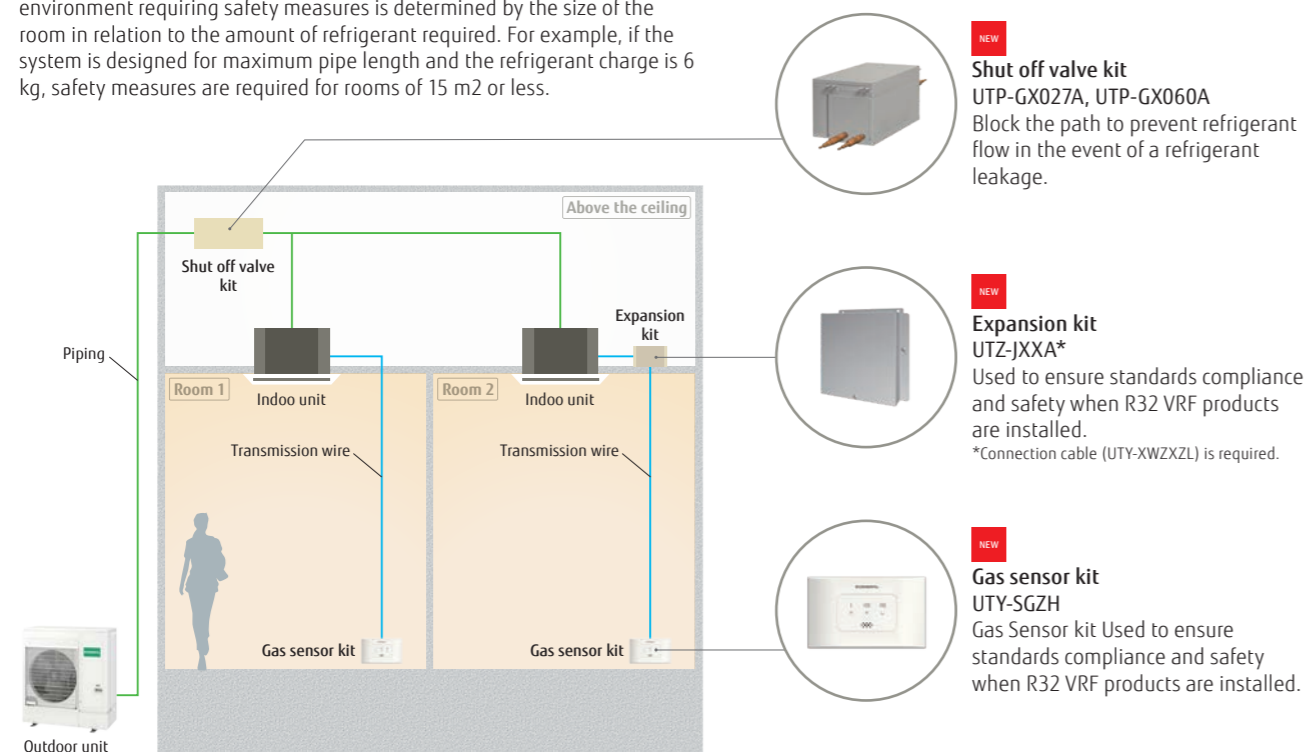

Saving CO2

TOP Class High Energy Saving

The use of large heat exchanger and a high-efficiency Rotary compressor achieves class-leading SEER/SCOP in all models.

SEER **8.27** *045 model
 SCOP **5.37** *040 model

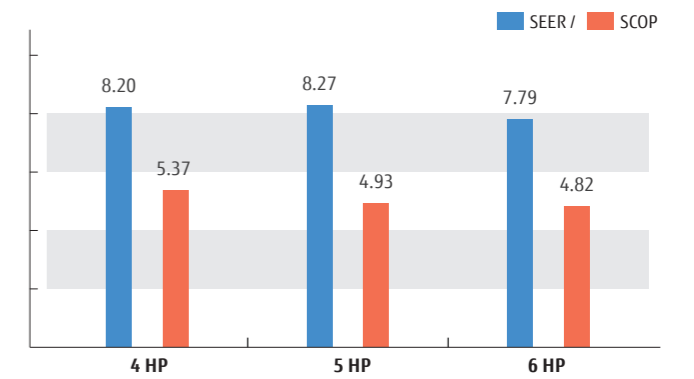

More Energy-Saving compressor control

When the room temperature approaches the set temperature after the start of operation, the capacity required for the outdoor unit becomes lower. The minimum compressor speed at this time can now be controlled at a lower value than with conventional products, enabling more energy-efficient operation.

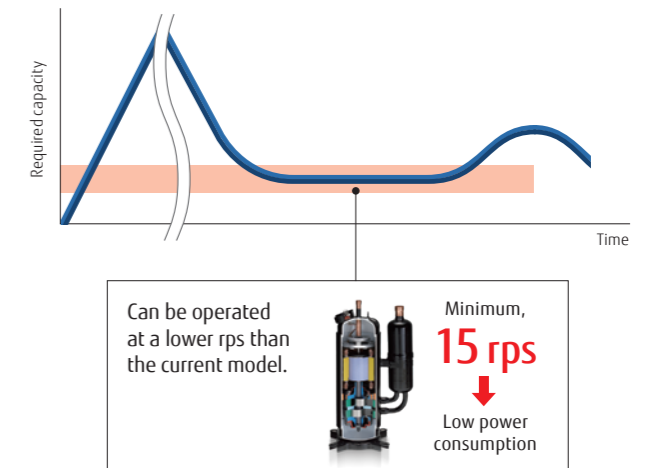

Small Body

Easy to carry, easy to install

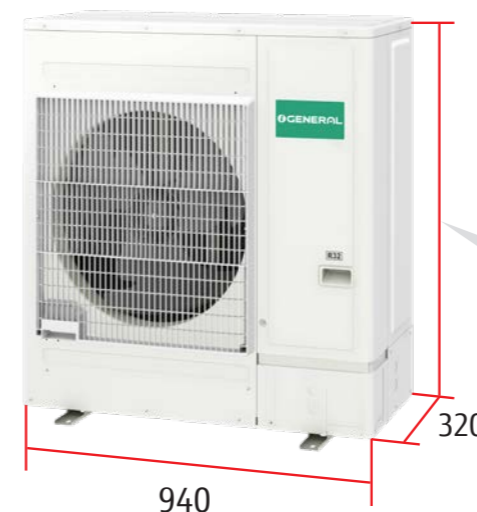

Light **74kg**

Height difference **998mm**

Small, lightweight outdoor unit

The outdoor units in this series are much more compact than conventional outdoor units of comparable capacity. They can be installed on a balcony, fitting below the height of the railing. With a height of less than 1 m, they can be installed in tight spaces such as under windows.

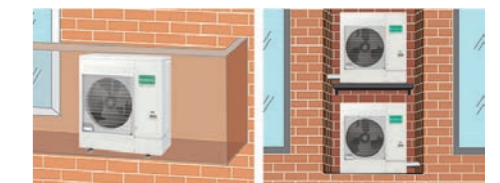

Low noise design

Significantly low noise levels are achieved by the use of a DC twin-rotary compressor, inverter technology, and an advanced airflow pattern design.

Situational Piping Design

Long pipe length

Our advanced refrigerant control technology extends the maximum allowable length of refrigerant piping to 120 m. This provides high flexibility in system design.

Long piping lengths are achieved by installing a large-capacity accumulator. No liquid refrigerant is supplied to the compressor even when the required amount of refrigerant is charged in the long piping.

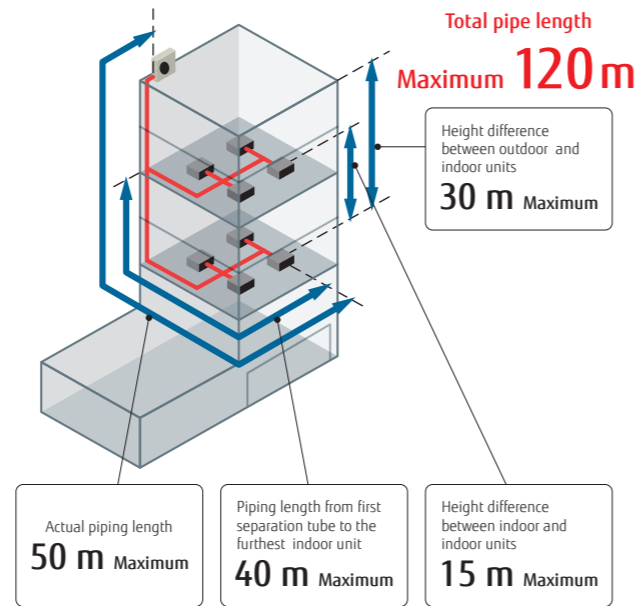
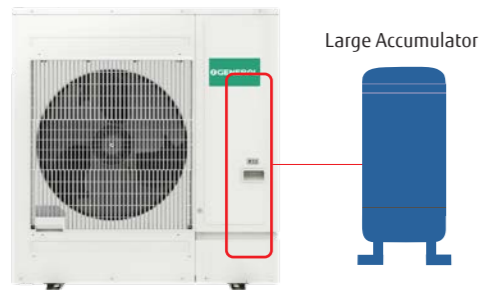

Up to 13 indoor units* can be connected

The combination of smaller but sufficiently powerful indoor units and a new outdoor unit with an optimized heat exchanging structure makes it possible to connect up to 13 indoor units, which is the best in its class.

*: 6 HP model

Rating Capacity range (HP)	4	5	6
Max. Connectable indoor unit	1-11	1-12	1-13

Sightliness installation

External static pressure

External static pressure measures up to 30 Pa for 4/5/6 HP models.

Even if the outdoor unit is installed in a small space to hide it, the grille and duct airflow path required for exhaust air can be installed up to a static pressure value of 30 Pa.

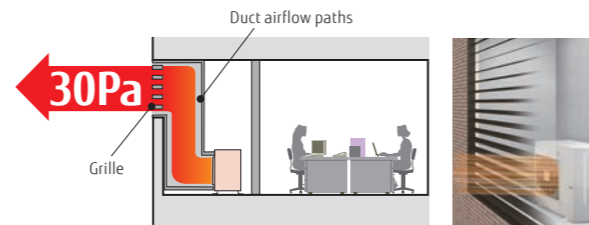

Cooling piping system

New Heat Rejection Technology Cooling piping system "Cooling piping system" is adopted to ensure reliability in high outside air.

Even when the outdoor unit is installed in an environment where heat tends to stay (small space), the cooling system using refrigerant can reduce damage caused by heat from PCBs.

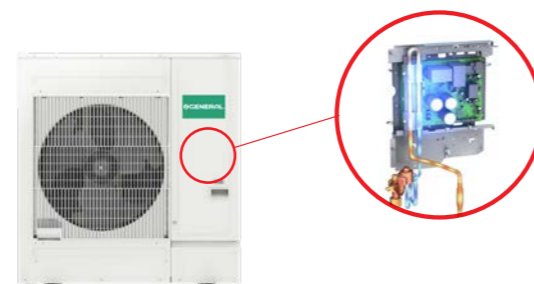

Specifications

Rated capacity range	HP	4	5	6
Model name		AJH040KCTAH	AJH045KCTAH	AJH054KCTAH
Maximum connectable indoor units		1-11	1-12	1-13
Power source		Single phase, ~230 V, 50 Hz		
Capacity	Cooling	14.0	14.0	15.1
	Nominal Heating	12.1	14.0	15.1
	Max. Heating	13.6	16.0	16.5
Input power	Cooling	3.15	3.82	4.48
	Nominal Heating	2.55	2.91	3.20
	Max. Heating	3.09	3.62	3.90
EER	Cooling	3.84	3.66	3.37
	Nominal Heating	4.74	4.80	4.71
	Max. Heating	4.40	4.41	4.22
SEER	Cooling	8.20	8.27	7.79
	Heating	5.37	4.93	4.82
SCOP	Cooling	8.20	8.27	7.79
	Heating	5.37	4.93	4.82
ηc	Cooling	325.0	328.0	308.6
ηh	Heating	212.0	194.0	189.8
Airflow rate		4,240	4,450	4,450
Sound pressure level/Power level	Cooling	52 / 70	53 / 71	54 / 72
	Heating	54 / 71	55 / 72	56 / 73
Heat exchanger fin		Blue fin	Blue fin	Blue fin
Net Dimensions	Height	998	998	998
	Width	940	940	940
	Depth	320	320	320
Weight		74	74	74
	kg			
Refrigerant	Type (Global Warming Potential)	R32 (675)	R32 (675)	R32 (675)
	Charge (kg (CO2eq-T))	2.7 (1.823)	2.7 (1.823)	2.7 (1.823)
Connection pipe diameter	Liquid	9.52	9.52	9.52
	Gas	15.88	15.88	15.88
Total pipe length		120	120	120
Max. height difference		30	30	30
Operating Range	Cooling	-5 to 46	-5 to 46	-5 to 46
	Heating	-20 to 21	-20 to 21	-20 to 21

Note: Specifications are based on the following conditions.
 Cooling: Indoor temperature of 27°CDB/19°CWB, and outdoor temperature of 35°CDB/24°CWB.
 Heating: Indoor temperature of 20°CDB/15°CWB, and outdoor temperature of 7°CDB/6°CWB.
 Pipe length: 7.5 m; Height difference between outdoor unit and indoor unit: 0 m.
 The protective function may work when using it outside the operation range.

Dimensions

(Unit: mm)

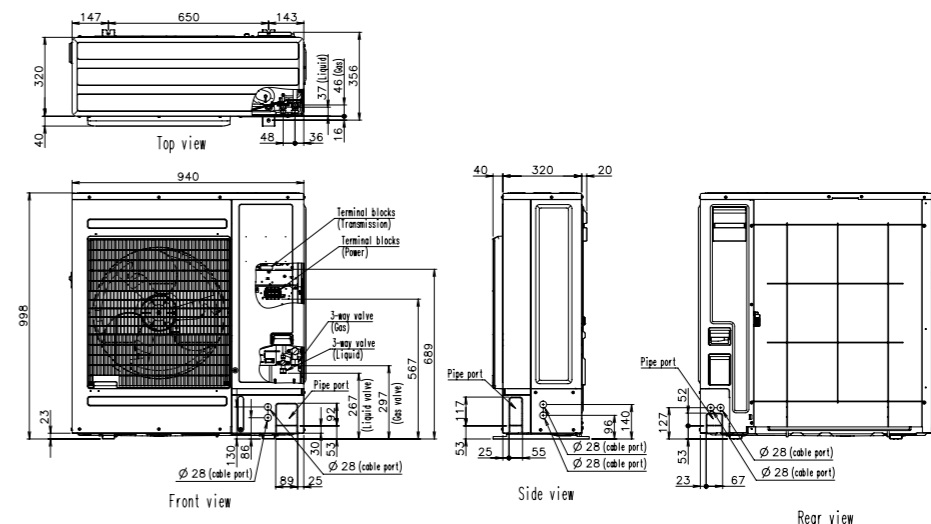



Heat Pump
for Small-capacity type

VRF **J-IVS**

System configuration example

- Suitable for air conditioning small and medium-size buildings. One refrigerant system is used for each outdoor unit.
- Multiple indoor units are connected with separation tubes and headers.

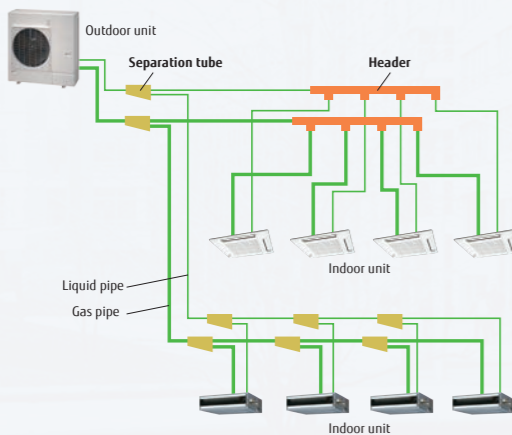

New intelligent refrigerant control

Fujitsu General is proposing outdoor units equipped with refrigerant control function. The refrigerant control operates with suitable control corresponding to the heat load of the room and offers a more comfortable environment. The refrigerant control can also provide increased energy savings.

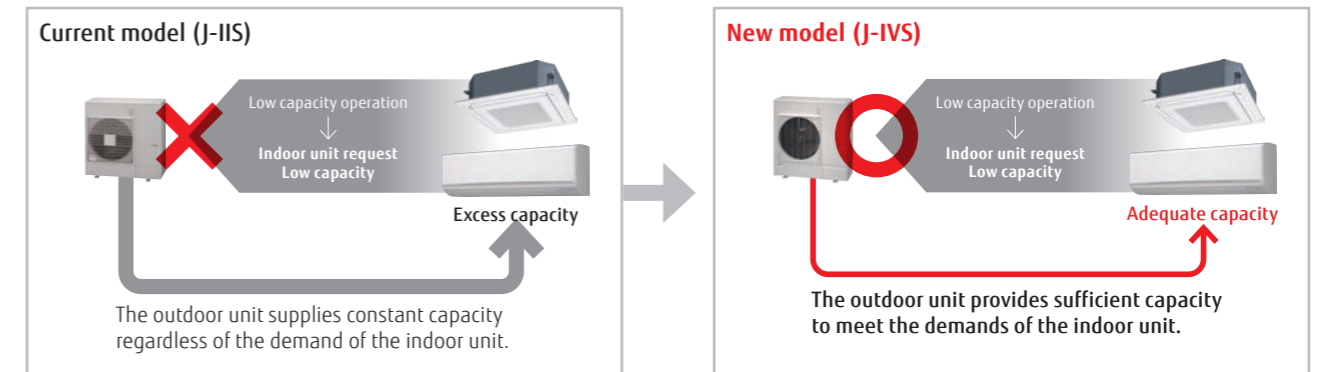

* The improvements due to the control and the actual sine wave vary depending on the combination of the indoor unit and system operating conditions.

External static pressure

External static pressure measures up to 25 Pa for 4/5/6 HP models.



Advanced high-efficiency technology

Large propeller fan
A large propeller fan with an optimized blade angle achieves both high performance and low noise operation.

DC fan motor
A small, multi-stage DC fan motor provides high-efficiency and low noise operation.

Large heat exchanger
The large 3-row heat exchanger substantially improves heat-exchanging performance.

DC inverter control
The active filter module improves efficiency.

Compact and high-performance DC twin-rotary compressor
High-efficiency is achieved across compressor loads. Especially good performance is achieved in the low- to medium-load range.

High heat-transfer copper tube (Improved lead angle)

Low noise rubber
High-efficiency compressor motor
Optimized refrigerant flow design
Highly accurate parts

Compressor efficiency vs. Compressor capacity graph showing efficiency remains high up to 100% capacity.

Easy to carry, easy to install

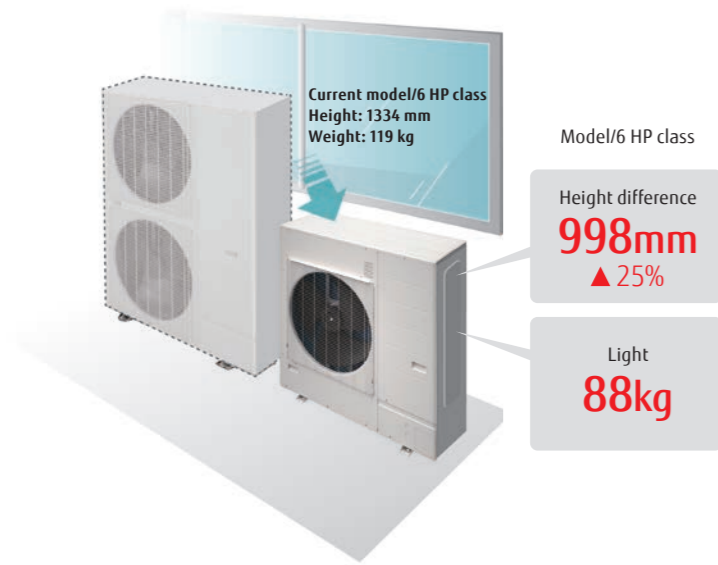

Small, lightweight outdoor unit

The outdoor units in this series are much more compact than conventional outdoor units of comparable capacity. They can be installed on a balcony, fitting below the height of the railing. With a height of less than 1 m, they can be installed in tight spaces such as under windows.

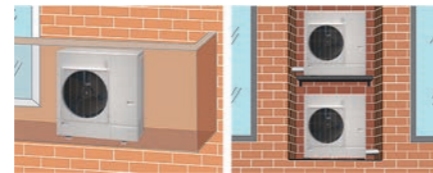

Low noise design

Significantly low noise levels are achieved by the use of a DC twin-rotary compressor, inverter technology, and an advanced airflow pattern design.



Long pipe length

Our advanced refrigerant control technology extends the maximum allowable length of refrigerant piping to 80 m. This provides high flexibility in system design.

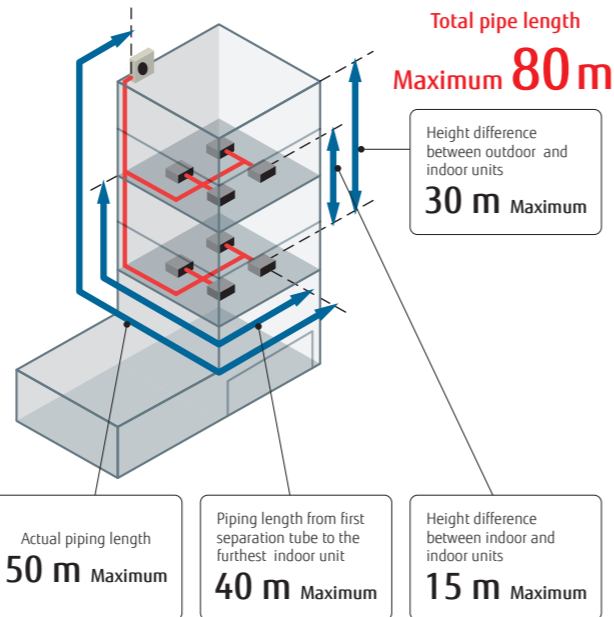

Up to 13 indoor units* can be connected

The combination of smaller but sufficiently powerful indoor units and a new outdoor unit with an optimized heat exchanging structure makes it possible to connect up to 13 indoor units, which is the best in its class.

*: 6 HP model

Model	Current model (J-IVS)			New model (J-IVS)		
	4	5	6	4	5	6
Rating Capacity range (HP)	4	5	6	4	5	6
Max. Connectable indoor unit	1-7	1-8	1-8	1-11	1-12	1-13

Non-stop oil recovery operation

A comfortable room condition is maintained during oil recovery mode because the product continues to operate without stopping the cooling or heating operation.

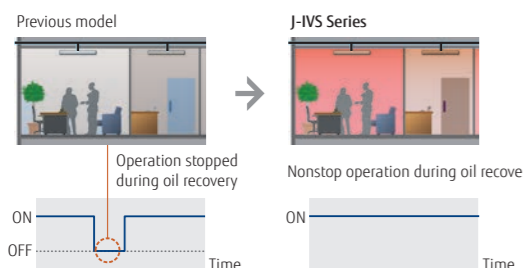

Easier installation

Connection check function: Wiring connections and address settings can be checked thanks to the quick check run function.

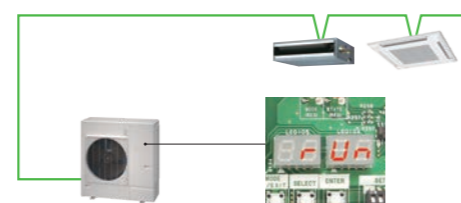

- Displays the number of each connected indoor unit.
- Displays the duplicate address number assigned to an indoor unit.

Specifications

Rated capacity range	HP	4	5	6
Model name		AJH040LCLDH	AJH045LCLDH	AJH054LCLDH
Maximum connectable indoor units		1-11	1-12	1-13
Power source		Single phase, ~230 V, 50 Hz		
Capacity	Cooling	12.1	14.0	15.1
	Nominal Heating	12.1	14.0	15.1
	Max. Heating	13.6	16.0	16.5
Input power	Cooling	3.75	4.71	5.55
	Nominal Heating	3.22	3.77	4.33
	Max. Heating	3.99	5.04	5.32
EER	Cooling	3.22	2.97	2.72
COP	Nominal Heating	3.75	3.71	3.48
	Max. Heating	3.40	3.17	3.10
SEER	Cooling	5.83	5.58	5.47
SCOP	Heating	3.82	3.96	3.99
ηc	Cooling	230.2	220.2	215.8
ηh	Heating	149.8	155.4	156.6
Airflow rate		4,240	4,400	4,400
Sound pressure level/Power level	Cooling	53 / 67	53 / 69	54 / 70
	Heating	54 / 68	56 / 69	56 / 70
Heat exchanger fin		Blue fin	Blue fin	Blue fin
Net Dimensions	Height	998	998	998
	Width	970	970	970
	Depth	370	370	370
Weight		88	88	88
	Type (Global Warming Potential)	R410A (2,088)	R410A (2,088)	R410A (2,088)
Refrigerant	Charge	4.0 (8.4)	4.0 (8.4)	4.0 (8.4)
	Liquid	9.52	9.52	9.52
Connection pipe diameter	Gas	15.88	15.88	15.88
	Total pipe length	80	80	80
Max. height difference		30	30	30
	Operating Range	Cooling	-5 to 46	-5 to 46
	Heating	-20 to 21	-20 to 21	-20 to 21

Note: Specifications are based on the following conditions.
Cooling: Indoor temperature of 27°CDB/19°CWB, and outdoor temperature of 35°CDB/24°CWB.
Heating: Indoor temperature of 20°CDB/15°CWB, and outdoor temperature of 7°CDB/6°CWB.
Pipe length: 7.5 m; Height difference between outdoor unit and indoor unit: 0 m.
The protective function may work when using it outside the operation range.

Dimensions

(Unit: mm)

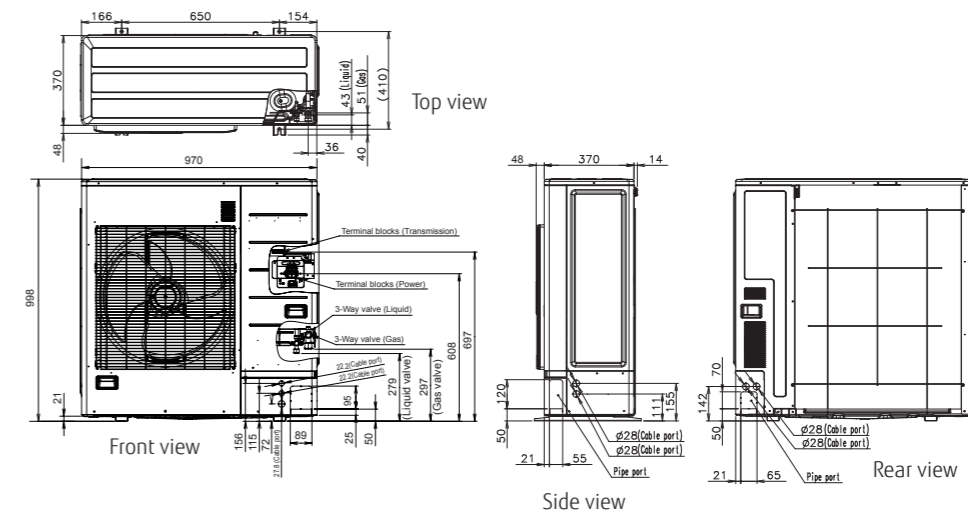



Heat Pump

for Small-capacity type

VRF J-IV

System configuration example

- Suitable for air conditioning small and medium-size buildings. One refrigerant system is used for each outdoor unit.
- Multiple indoor units are connected with separation tubes and headers.

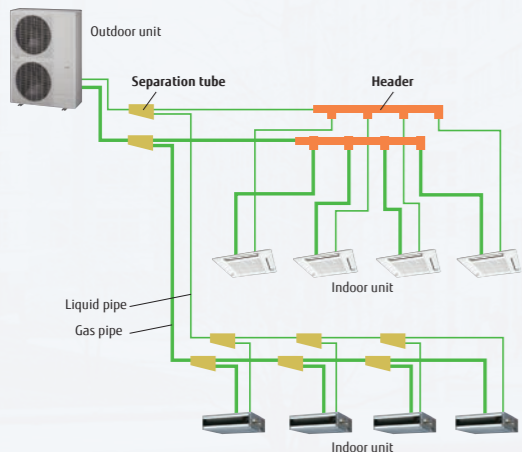

New intelligent refrigerant control

Fujitsu General is proposing outdoor units equipped with refrigerant control function. The refrigerant control operates with suitable control corresponding to the heat load of the room and offers a more comfortable environment. The refrigerant control can also provide increased energy savings.

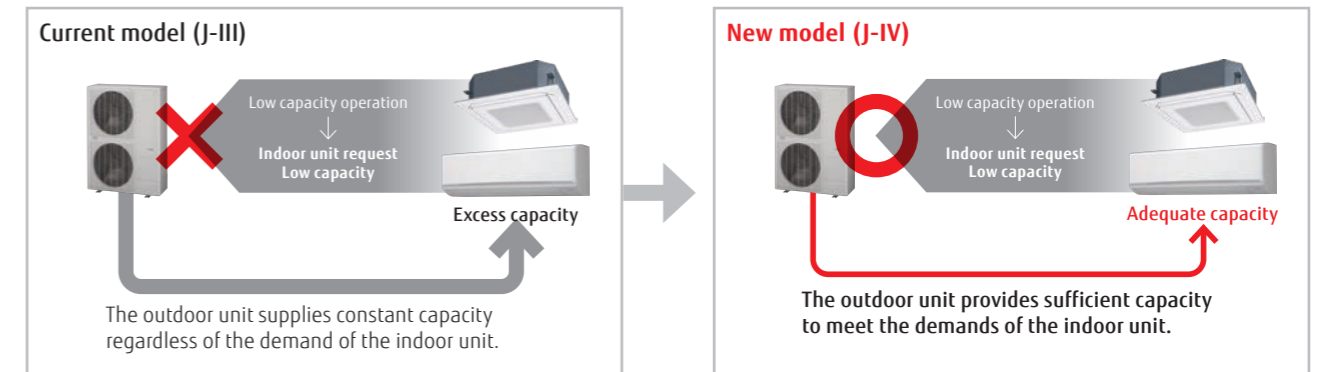

* The improvements due to the control and the actual sine wave vary depending on the combination of the indoor unit and system operating conditions.

External static pressure

External static pressure measures up to 30 Pa for 4/5/6 HP.



Advanced high-efficiency technology

Large propeller fan
A large propeller fan with an optimized blade angle achieves both high performance and low noise operation.

DC fan motor
A small, multi-stage DC fan motor contributes to high-efficiency and low noise operation.

Large heat exchanger
The large 3-row heat exchanger substantially improves heat-exchanging performance.

DC twin-rotary compressor
High-efficiency is achieved across compressor loads. Especially good performance is achieved in the low- to medium-load range.

Subcooling heat exchanger
The dual-tube heat exchanger improves cooling performance.

DC inverter control
The active filter module improves efficiency.

High-efficiency compressor motor
Optimized refrigerant flow design
Highly accurate parts

Pressure
Enthalpy
Cooling performance improved

Compressor efficiency
Compressor capacity
DC Twin-Rotary Compressor



Heat Pump for Small-capacity type

VRF J-IVL

System configuration example

- Suitable for air conditioning small and medium-size buildings. One refrigerant system is used for each outdoor unit.
- Multiple indoor units are connected with separation tubes and headers.

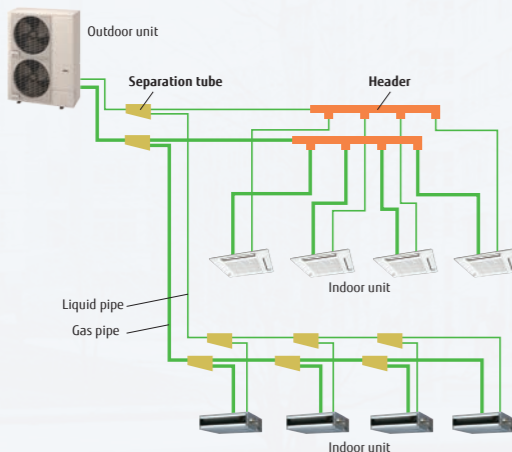

New intelligent refrigerant control

Fujitsu General is proposing outdoor units equipped with refrigerant control function. The refrigerant control operates with suitable control corresponding to the heat load of the room and offers a more comfortable environment. The refrigerant control can also provide increased energy savings.

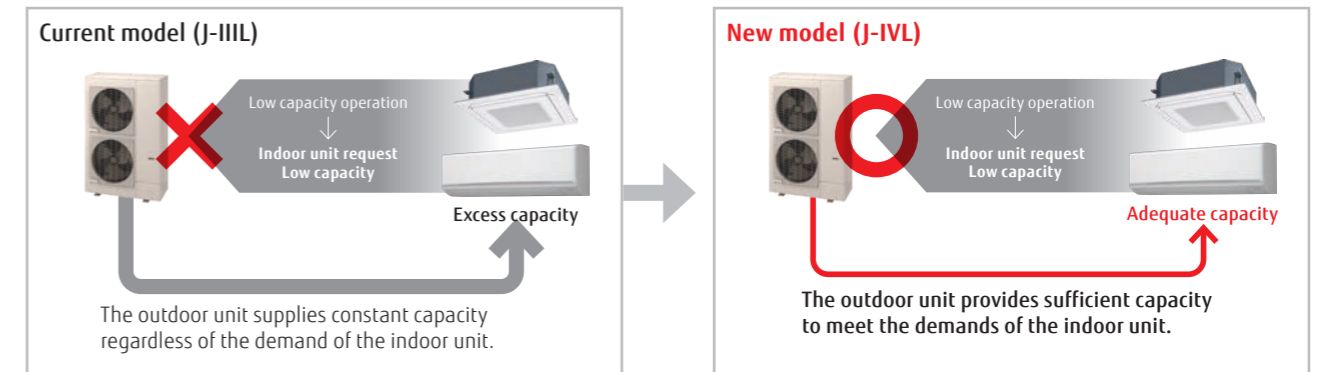

* The improvements due to the control and the actual sine wave vary depending on the combination of the indoor unit and system operating conditions.

External static pressure

External static pressure is available up to 60 Pa for 14/16/18 HP. (30 Pa for 8/10 HP, 40 Pa for 12 HP)

Capacities are slightly decreased relative to the rated values during high static pressure operations.



Advanced high-efficiency technology

Ø570 mm Large propeller fan
A large-diameter propeller fan with our proprietary blade design reduces draft loss, which results in high-efficiency and low noise operation.

DC fan motor
A small, multi-stage DC fan motor provides high-efficiency and low noise operation.

Large heat exchanger
The large 2.6-row heat exchanger substantially improves heat-exchanging performance.

DC inverter control
The active filter module improves efficiency.

Subcooling heat exchanger
The dual-tube heat exchanger improves cooling performance.

Scroll compressor
The combination of a scroll compressor with a wide rotational frequency range from 15 to 130 rps and our proprietary sensorless sine-wave control that smoothly controls the input power into the motor achieves more energy-efficient and quieter operation.

15 to 130 rps



Fujitsu General offers a perfect total air conditioning system for small office buildings with multiple small rooms, taking into consideration energy savings, low noise, comfortable air volume, usage and purpose, and centralized control.

VRF J-IVL

Image: 8/10/12 HP models

Slim & Compact design



Various installation methods

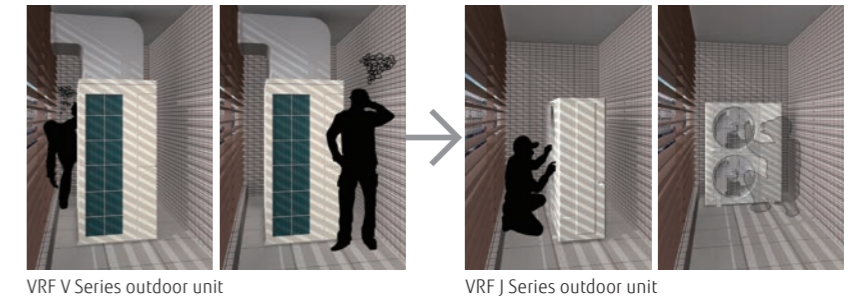

Installation
Low noise level in consideration of nearby residents

Front air discharge type with a width of about 1,000 mm, allowing for flexible installation even in narrow spaces.

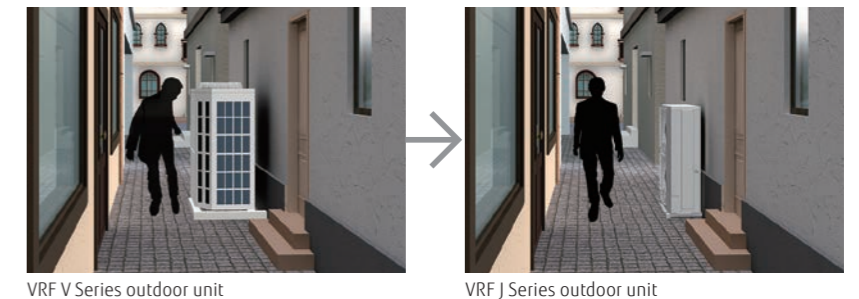

Narrow space behind building
Space saving

Small and thin, allowing for direct ground or wall mounting installations even in narrow alleys.



Installation on the back street of a building
Flexible installation

Slim, low-body front air discharge meets the requirements for installation even in tight spaces. Installation flexibility without blocking the windows of buildings contributes to substantial space savings, even when multiple units are installed.

Efficiency in actual operating conditions

The use of a large heat exchanger and a high-efficiency Scroll compressor achieves class-leading EER/COP (Max. Heating) in all models.

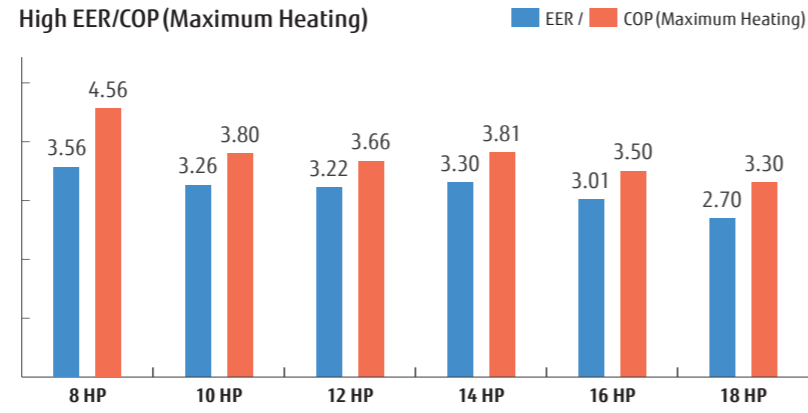

* These specifications are determined by cassette combination.

Long pipe length

Our advanced refrigerant control technology extends the maximum allowable length of refrigerant piping to 400 m. This provides high flexibility in system design.

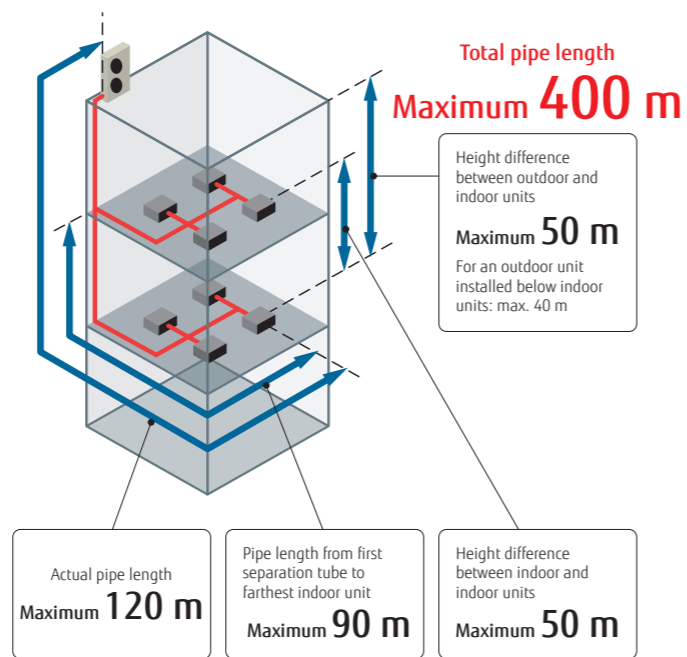

Up to 42 indoor units* can be connected.

The combination of smaller but sufficiently powerful indoor units and a new outdoor unit with an optimized heat exchanging structure makes it possible to connect up to 42 indoor units, which is the best in its class. *: 18 HP model

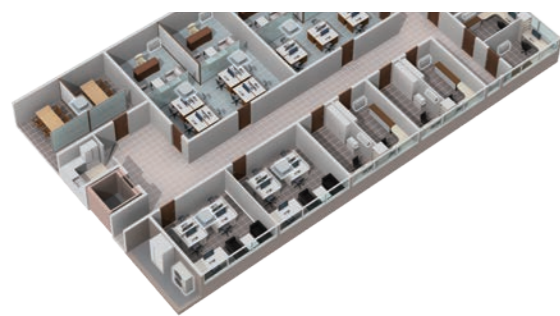

Class-leading low operating sound

The top-class low operating noise makes it ideal for use in densely populated areas. These low operating sound models are ideal for installation in densely populated areas.

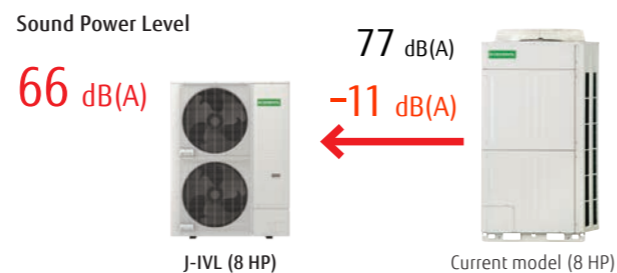

8,10,12 HP: AJH072LELDH / AJH090LELDH / AJH108LELDH
14,16,18 HP: AJH126LELDH / AJH144LELDH / AJH162LELDH



Specifications

Rated capacity range		HP	8	10	12	14	16	18
Model name			AJH072LELDH	AJH090LELDH	AJH108LELDH	AJH126LELDH	AJH144LELDH	AJH162LELDH
Maximum connectable indoor units			1-20	1-25	1-30	1-36	1-40	1-42
Power source			3-phase, ~400V, 50Hz					
Capacity	Cooling	kW	22.4	28.0	33.5	40.0	45.0	50.0
	Nominal Heating	kW	22.4	28.0	33.5	40.0	45.0	50.0
	Max. Heating	kW	25.0	31.5	37.5	45.0	50.0	55.0
Input power	Cooling	kW	6.30	8.59	10.42	12.12	14.96	18.52
	Nominal Heating	kW	4.65	6.61	8.18	9.71	11.81	13.66
	Max. Heating	kW	5.45	8.29	10.25	11.81	14.29	16.66
EER	Cooling		3.56	3.26	3.22	3.30	3.01	2.70
	Nominal Heating	W/W	4.82	4.24	4.10	4.12	3.81	3.66
COP	Max. Heating	W/W	4.56	3.80	3.66	3.81	3.50	3.30
	SEER	Cooling	7.62	7.50	7.27	7.27	7.00	6.29
SCOP	Heating		3.89	3.61	3.63	3.53	3.51	3.54
	ηc	Cooling	301.8	297.0	287.8	287.8	277.0	248.6
ηh	Heating	%	152.6	141.4	142.2	138.2	137.4	138.6
	Airflow rate	m³/h	8,400	9,000	11,000/12,100	13,000	14,000	14,800/15,300
Sound pressure level/ Power level	Cooling	dB(A)	52/66	54/69	59/73	62/75	64/77	65/79
	Heating	dB(A)	54/66	57/70	62/75	63/76	65/78	68/82
Net Dimensions	Height	mm	1,428	1,428	1,428	1,638	1,638	1,638
	Width	mm	1,080	1,080	1,080	1,080	1,080	1,080
	Depth	mm	480	480	480	480	480	480
Weight		kg	170	177	178	213	213	217
	Refrigerant	Type (Global Warming Potential)	R410A (2,088)	R410A (2,088)	R410A (2,088)	R410A (2,088)	R410A (2,088)	R410A (2,088)
Connection pipe diameter	Charge	kg (CO2eq-T)	7.0 (14.6)	7.5 (15.7)	7.5 (15.7)	11.0 (23.0)	11.0 (23.0)	11.8 (24.6)
	Liquid	mm	9.52	9.52	12.70	12.70	12.70	12.70
Total pipe length	Gas	mm	19.05	22.20	28.58	28.58	28.58	28.58
		m	400	400	400	400	400	400
Max. height difference			50/40 (Outdoor unit: Upper/Lower)					
	Cooling	°C	-15 to 46	-15 to 46	-15 to 46	-5 to 46*	-5 to 46*	-5 to 46*
Operating Range	Heating	°C	-20 to 21	-20 to 21	-20 to 21	-20 to 21	-20 to 21	-20 to 21

Note: Specifications are based on the following conditions.

Cooling: Indoor temperature of 27°CDB / 19°CWB, and outdoor temperature of 35°CDB / 24°CWB.

Heating: Indoor temperature of 20°CDB / 15°CWB, and outdoor temperature of 7°CDB / 6°CWB.

Pipe length: 7.5 m; Height difference between outdoor unit and indoor unit: 0 m.

* The cooling operation range of -15 to 46°C is allowed only when all of the indoor units connected to the system are higher than capacity of 5.6kW.

Dimensions

(Unit: mm)

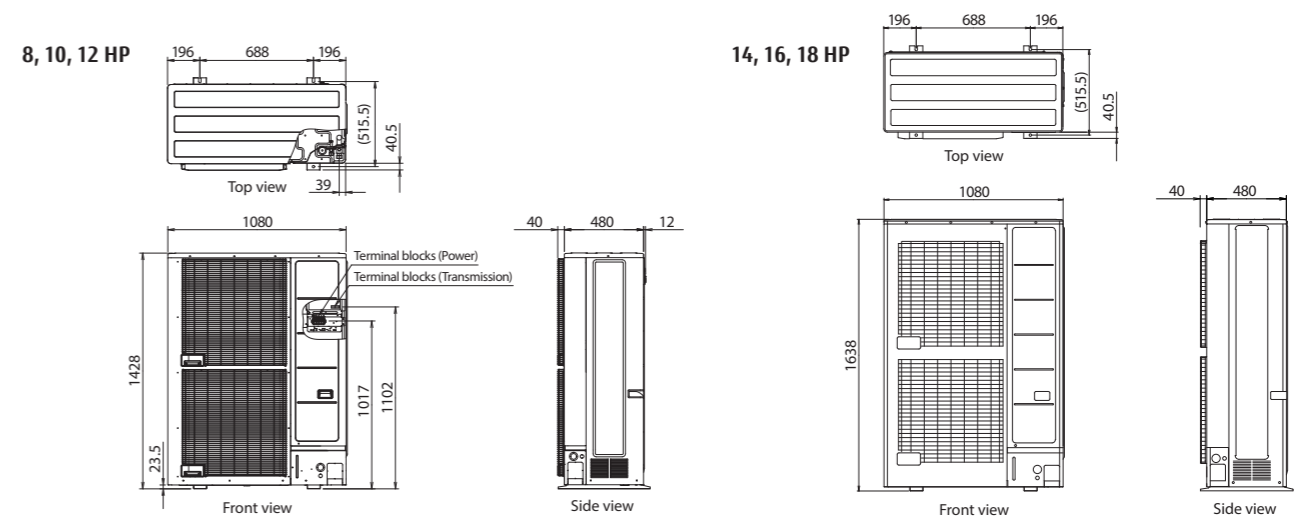



Heat Recovery Modular type

VRF VR-IV

Highly energy-efficient operation

Our heat recovery systems achieve high operating energy efficiency by drawing heat from the room to be cooled and transferring it as energy for rooms that are to be heated.

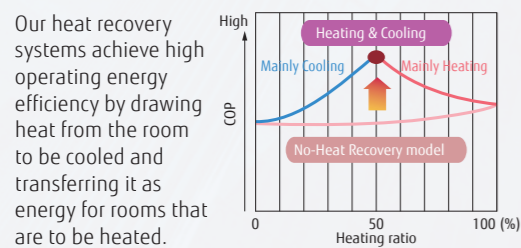
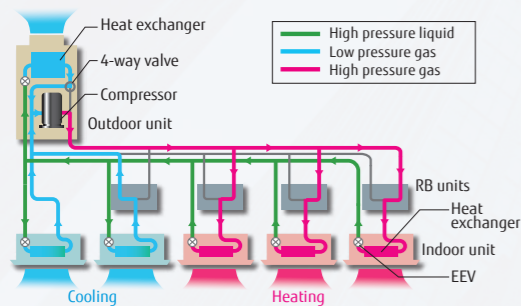

New intelligent refrigerant control

Fujitsu General is proposing outdoor units equipped with refrigerant control function. The refrigerant control operates with suitable control corresponding to the heat load of the room and offers a more comfortable environment. The refrigerant control can also provide increased energy savings.

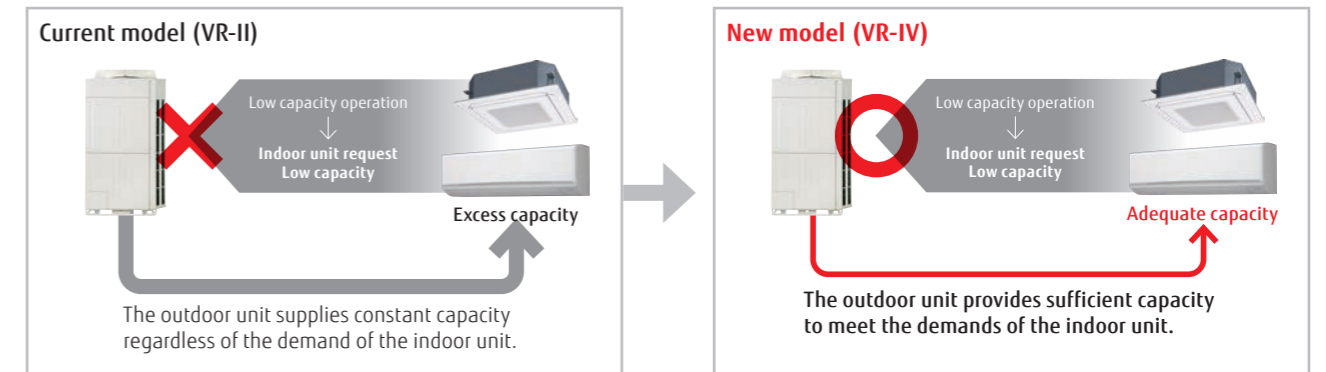

* The improvements due to the control and the actual sine wave vary depending on the combination of the indoor unit and system operating conditions.

Increase in the number of connectable indoor units

Capacity range of connectable indoor units

New model (VR-IV)	25%* to 150%
Current model (VR-II)	50% to 150%

*: For modular type, 25% to 49.9% operation in the entire system is available. (by one unit operation)

Increased number of connectable indoor units and space saving combinations

HP	10	12	14	16	...	28	30	32	...	48	
New model (VR-IV)	21	26	30	34	...	60	64	64	...	64	
Current model (VR-II)	15	16	17	21	24	...	42	45	48	...	64

The energy-saving technology that boosted operation efficiency

- Powerful large propeller fan**
The fan uses CFD* technology to achieve both high performance and low noise operation.
*CFD: Computational Fluid Dynamics
- 3-phase DC fan motor**
The use of a DC fan motor with sophisticated driver control improves energy efficiency substantially. In addition, this motor operates quietly.
- Subcooling heat exchanger**
High heat exchange efficiency is achieved by using an internal projection-shape double-pipe construction.
- High-efficient, large-capacity DC twin-rotary compressor**
Large-capacity high-efficient DC twin-rotary compressor with excellent intermediate capability.
- Sine-wave DC inverter control**
High-efficiency is realized by the adoption of reduced switching loss IPM.
- 4-face heat exchanger**
The 4-face heat exchanger increases the effective surface area and significantly improves heat-exchanging efficiency.
- Front intake port (Corner cut air inlet structure)**
In multiple outdoor unit installations, the unique front intake design improves airflow into the heat exchanger.

Extended connection ratio (applicable to multiple tenants)

Especially useful when starting partial air conditioning in a building under construction
Installation can be added flexibly for each tenant.



Stand-alone

Current model (VR-II)

Example) 50% of 12HP minimum connected indoor unit capacity is required

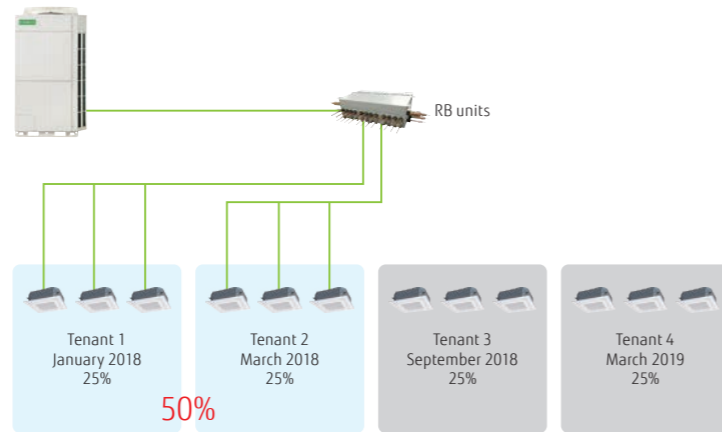

Installation is possible even for tenants who have not yet started operations.

New model (VR-IV)

Example) 25% of 12HP minimum connected indoor unit capacity is required

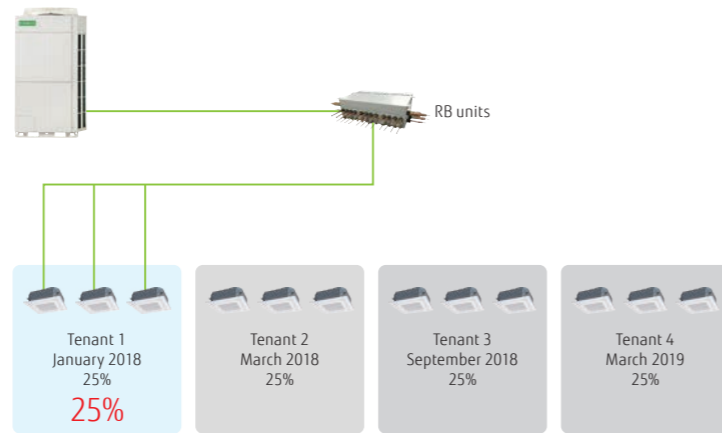

Installation and commissioning can be added flexibly to meet the opening dates of other tenants.

Modular type

One outdoor unit operates effectively for the capacities of connectable indoor units in the entire system. (Each of the multiple outdoor units does not dare to operate at 25% capacity: any one of the outdoor units will operate at 50% and the remaining units will each output 0%, i.e., stop operating.)

Example: One 10HP outdoor unit performs 25% of the total 20HP outdoor units system.
One 10HP outdoor unit performs 50% of its capacity
→ Two outdoor units do not perform 25% of the operation.

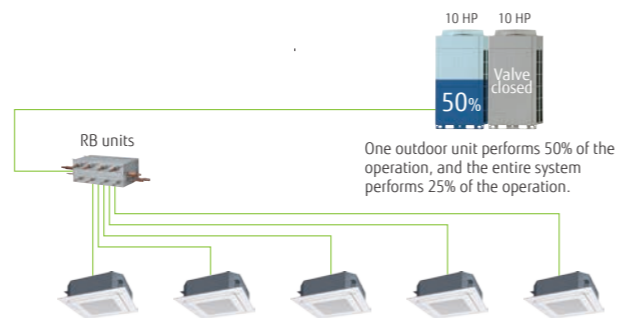

Additional installation is possible without changing the main pipe.

A main pipe of a diameter that can be used for the final system is installed at the beginning of the installation.
Duplication of the work will be avoided as there is no need to change the main pipe as in the previous model.

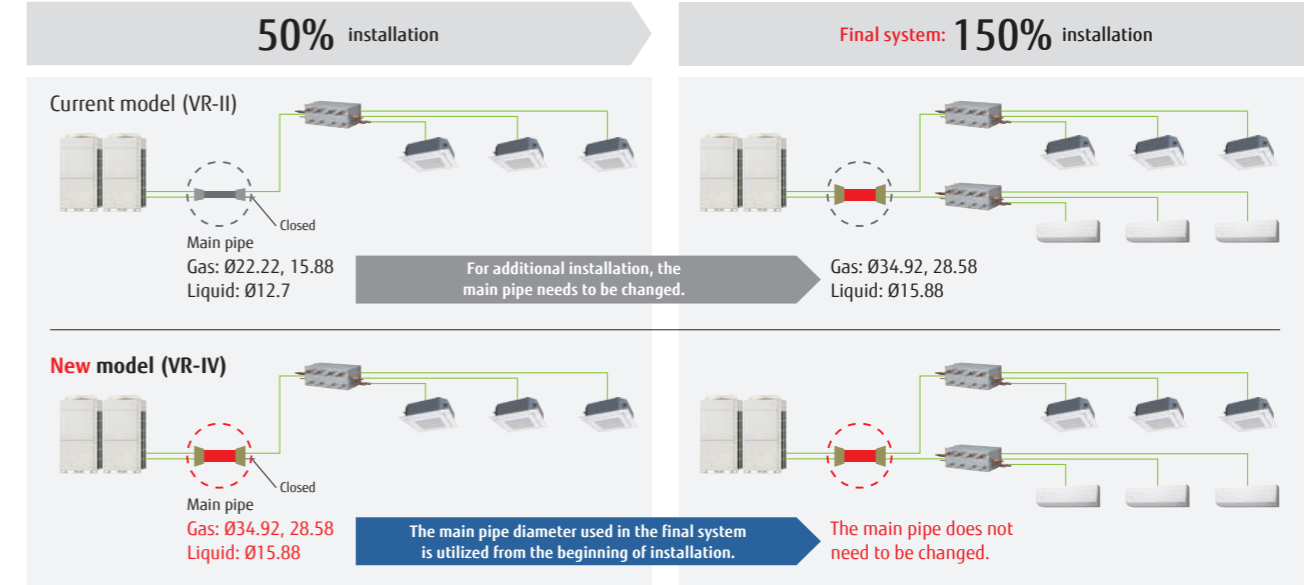

All-inverter compressor

Large-capacity DC inverter compressor

Large-capacity high-efficient DC twin-rotary compressor with excellent intermediate capability.



High-efficiency compressor speed control

The compressor speed control in 0.1 Hz increments ensures a comfortable space with less change in room temperature and less energy loss.

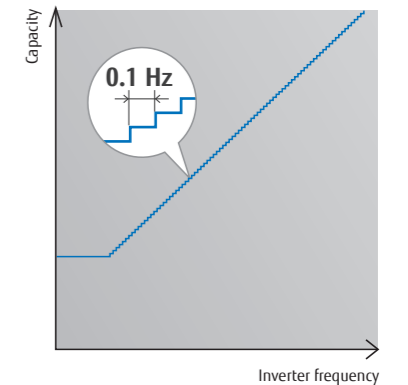

Efficiency in actual operating conditions

Class-leading high COP (Maximum) The use of our proprietary heat exchanger structure and high-efficiency DC twin-rotary compressors achieves the class-leading coefficient of performance (COP) in every combination.

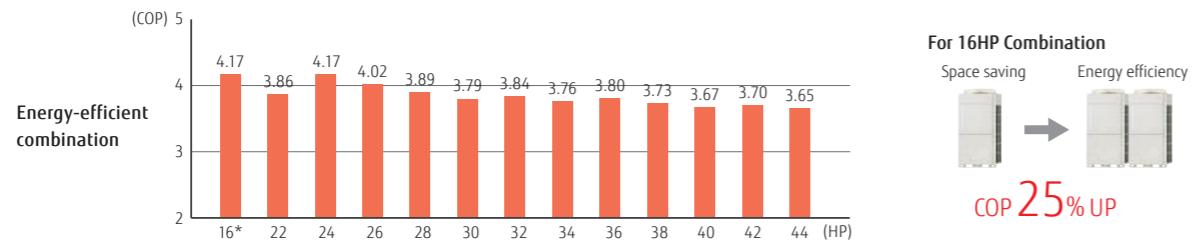
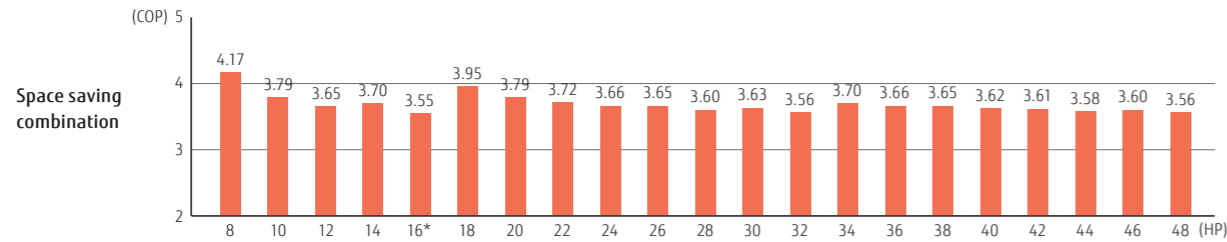

* These specifications are determined by Cassette combination.
 *Multiple outdoor units are not certified by Eurovent.

Multiple outdoor operation control

When multiple outdoor units are connected, each compressor carries out sophisticated operation. Instead of operating one compressor at full load to distribute the refrigerant to one heat exchanger, all compressors operate at partial load to distribute the refrigerant to all heat exchangers, thereby improving the efficiency of the entire system.

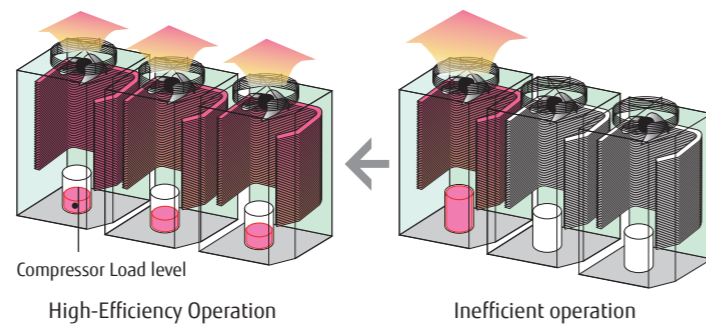

Heat exchanger refrigerant control

The heat exchanger in the outdoor unit is divided into two parts, upper and lower. The efficiency of the heat exchanger has been improved by adopting an optimum refrigerant path control where the refrigerant is distributed more into the top heat exchanger as this is where there is a greater air flow intake.

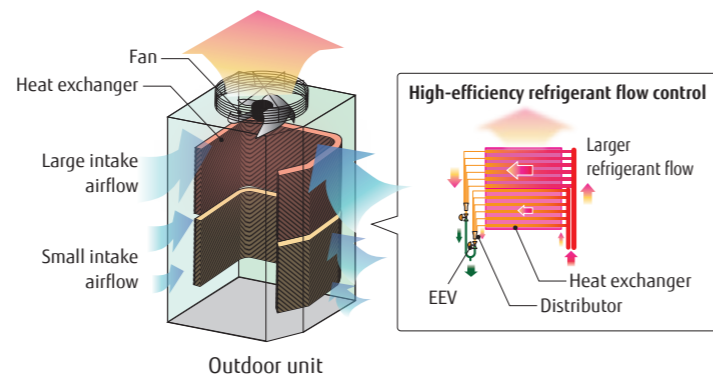

Flexible pipe connection

More flexible refrigerant pipe work is possible due to the use of various piping and RB unit connections, for adjustments to the floor layout and building structure.

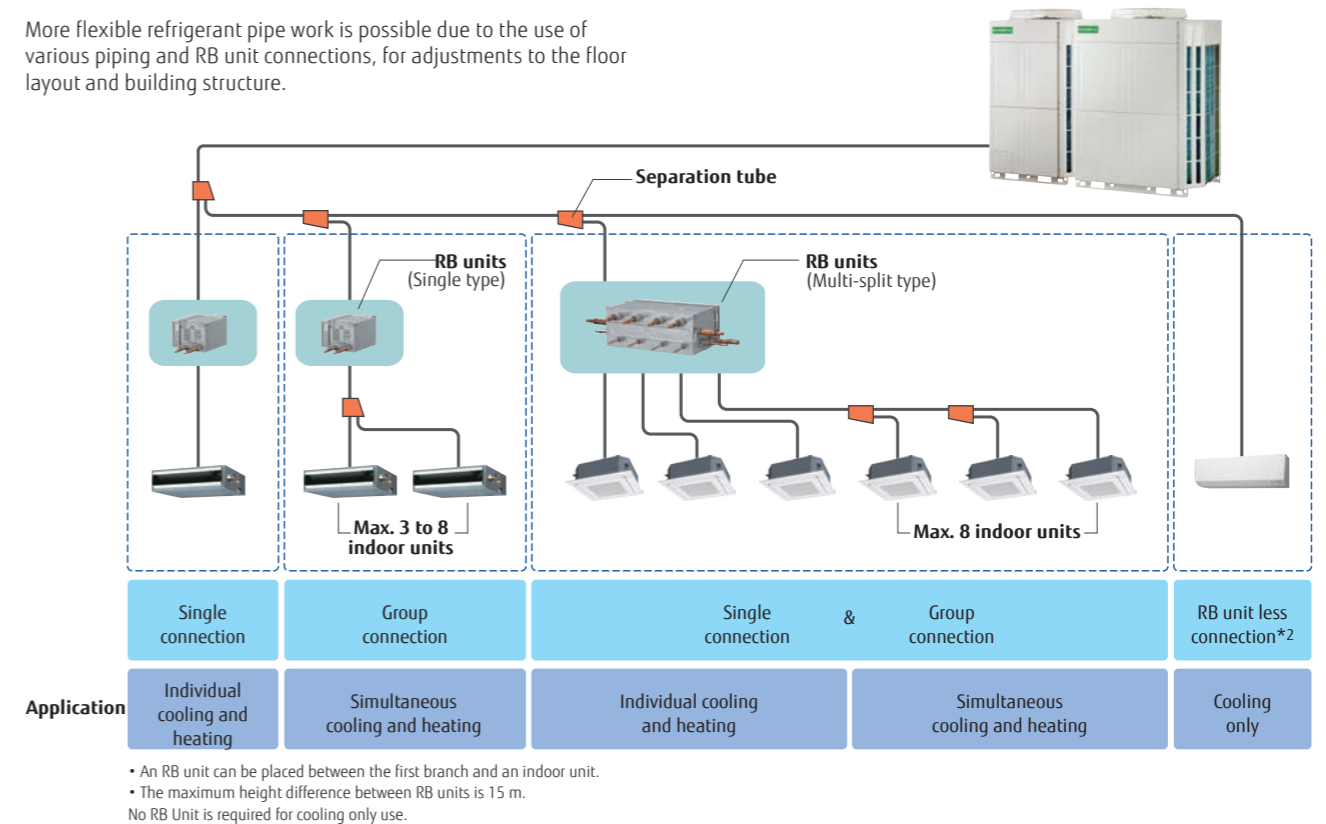

Flexible installation of RB unit

Small and slim design with a height of 198 mm makes it easy to install in tight spaces with height constraints.

- A drain pipe is not required.
- Different positions of a control box can be chosen to accommodate installation conditions.
- Series connection for simplified installation

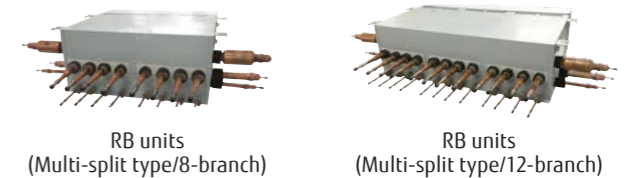
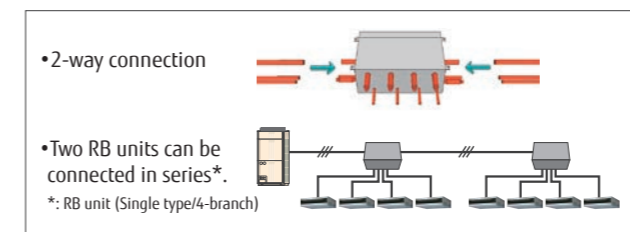
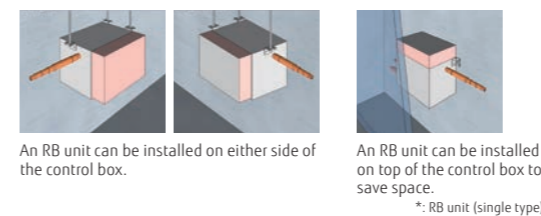

Easy maintenance in tight spaces

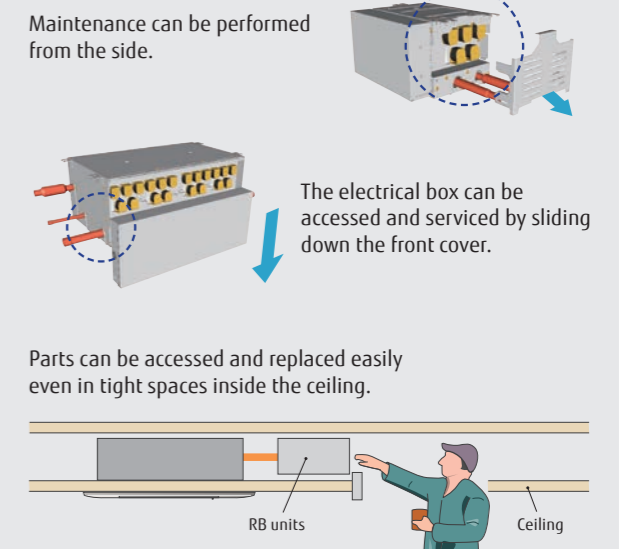

Outdoor units lineup • Combinations other than those listed below are not recommended.

Space saving combination

22.4kW (8HP) AJH072GALDH UNIT : AJH072GALDH	28.0kW (10HP) AJH090GALDH UNIT : AJH090GALDH	33.5kW (12HP) AJH108GALDH UNIT : AJH108GALDH	40.0kW (14HP) AJH126GALDH UNIT : AJH126GALDH	45.0kW (16HP) AJH144GALDH UNIT : AJH144GALDH
50.4kW (18HP) AJH162GALDH UNIT : AJH090/072GALDH	56.0kW (20HP) AJH180GALDH UNIT : AJH090/090GALDH	61.5kW (22HP) AJH198GALDH UNIT : AJH108/090GALDH	67.0kW (24HP) AJH216GALDH UNIT : AJH108/108GALDH	73.0kW (26HP) AJH234GALDH UNIT : AJH144/090GALDH
78.5kW (28HP) AJH252GALDH UNIT : AJH144/108GALDH	85.0kW (30HP) AJH270GALDH UNIT : AJH144/126GALDH	90.0kW (32HP) AJH288GALDH UNIT : AJH144/144GALDH	95.0kW (34HP) AJH306GALDH UNIT : AJH108/108/090GALDH	100.5kW (36HP) AJH324GALDH UNIT : AJH108/108/108GALDH
106.5kW (38HP) AJH342GALDH UNIT : AJH144/108/090GALDH	112.0kW (40HP) AJH360GALDH UNIT : AJH144/108/108GALDH	118.0kW (42HP) AJH378GALDH UNIT : AJH144/144/090GALDH	123.5kW (44HP) AJH396GALDH UNIT : AJH144/144/108GALDH	130.0kW (46HP) AJH414GALDH UNIT : AJH144/144/126GALDH
135.0kW (48HP) AJH432GALDH UNIT : AJH144/144/144GALDH				

Energy efficiency combination

44.8kW (16HP) AJH144GALDHH UNIT : AJH072/072GALDH	62.4kW (22HP) AJH198GALDHH UNIT : AJH126/072GALDH	67.2kW (24HP) AJH216GALDHH UNIT : AJH072/072/072GALDH	72.8kW (26HP) AJH234GALDHH UNIT : AJH090/072/072GALDH	78.4kW (28HP) AJH252GALDHH UNIT : AJH090/090/072GALDH
84.0kW (30HP) AJH270GALDHH UNIT : AJH090/090/090GALDH	90.4kW (32HP) AJH288GALDHH UNIT : AJH126/090/072GALDH	96.0kW (34HP) AJH306GALDHH UNIT : AJH126/090/090GALDH	102.4kW (36HP) AJH324GALDHH UNIT : AJH126/126/072GALDH	108.0kW (38HP) AJH342GALDHH UNIT : AJH126/126/090GALDH
113.0kW (40HP) AJH360GALDHH UNIT : AJH144/126/090GALDH	120.0kW (42HP) AJH378GALDHH UNIT : AJH126/126/126GALDH	125.0kW (44HP) AJH396GALDHH UNIT : AJH144/126/126GALDH		

8,10,12HP : AJH072GALDH / AJH090GALDH / AJH108GALDH
14,16HP : AJH126GALDH / AJH144GALDH



Dimensions

(Unit: mm)

8, 10, 12 HP

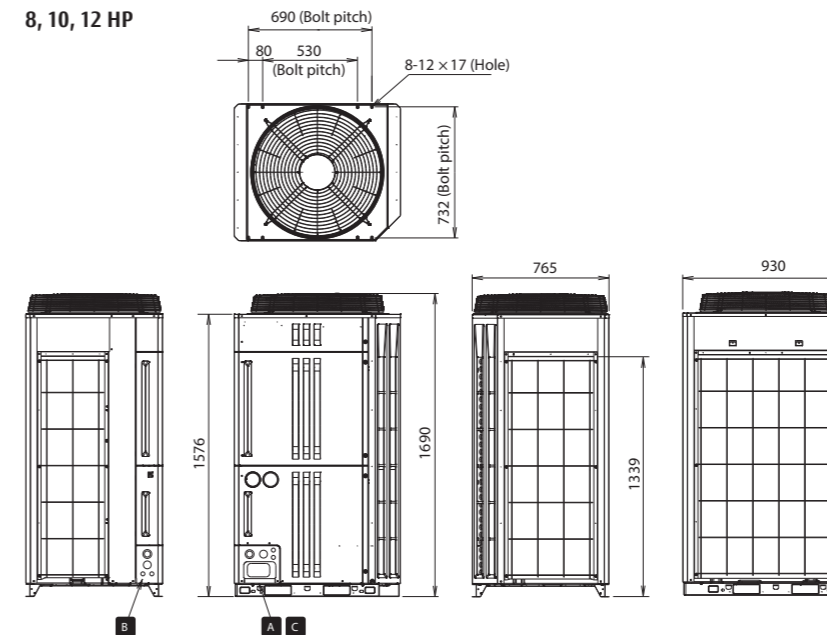

14, 16 HP

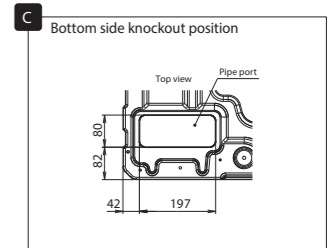
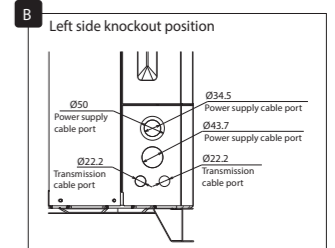
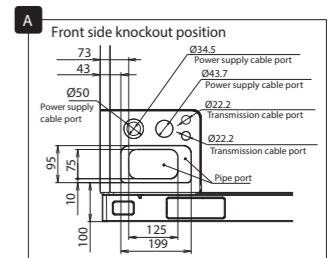
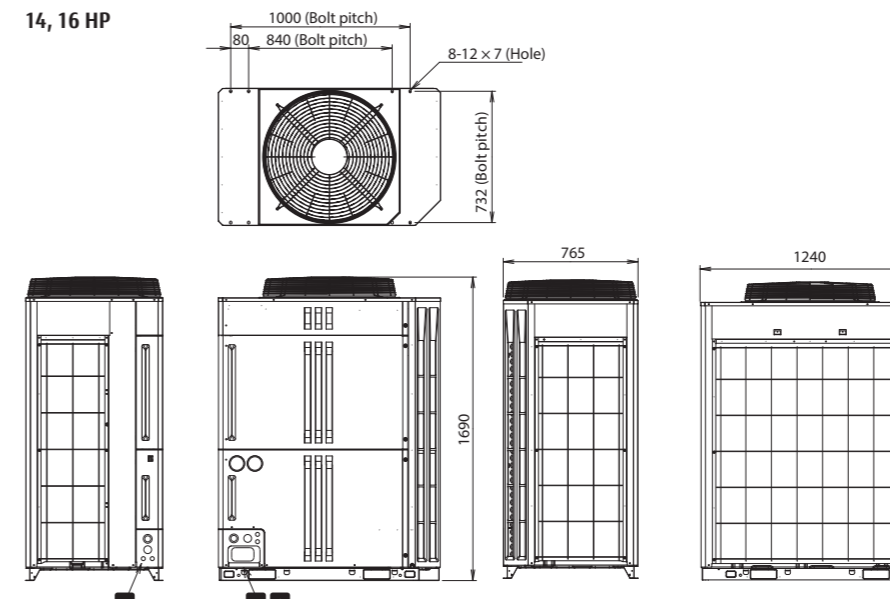

Outdoor units specifications

Space saving combination

Rated capacity range		HP	8	10	12	14	16	18	20	22	24	26	28	30	32	34	36	38	40	42	44	46	48	
Model name			AJH072GALDH	AJH090GALDH	AJH108GALDH	AJH126GALDH	AJH144GALDH	AJH162GALDH	AJH180GALDH	AJH198GALDH	AJH216GALDH	AJH234GALDH	AJH252GALDH	AJH270GALDH	AJH288GALDH	AJH306GALDH	AJH324GALDH	AJH342GALDH	AJH360GALDH	AJH378GALDH	AJH396GALDH	AJH414GALDH	AJH432GALDH	
Unit 1 Unit 2 Unit 3			AJH072GALDH	AJH090GALDH	AJH108GALDH	AJH126GALDH	AJH144GALDH	AJH090GALDH AJH072GALDH	AJH090GALDH AJH090GALDH	AJH108GALDH AJH090GALDH	AJH108GALDH AJH126GALDH	AJH144GALDH AJH108GALDH	AJH144GALDH AJH108GALDH	AJH144GALDH AJH126GALDH	AJH144GALDH AJH144GALDH	AJH108GALDH AJH108GALDH AJH108GALDH	AJH108GALDH AJH108GALDH AJH108GALDH	AJH144GALDH AJH108GALDH AJH108GALDH	AJH144GALDH AJH108GALDH AJH108GALDH	AJH144GALDH AJH108GALDH AJH108GALDH	AJH144GALDH AJH108GALDH AJH108GALDH	AJH144GALDH AJH144GALDH AJH144GALDH	AJH144GALDH AJH144GALDH AJH144GALDH	
Maximum connectable indoor units*			17	21	26	30	34	39	43	47	52	56	60	64	64	64	64	64	64	64	64	64	64	
Connectable capacity range of indoor units		kW	5.6-33.6	7.0-42.0	8.4-50.2	10.0-60.0	11.3-67.5	12.6-75.6*3	14.0-84.0*3	15.4-92.2*3	16.8-100.5*3	18.3-109.5*3	19.7-117.7*3	21.3-127.5*3	22.5-135.0*3	23.8-142.5*3	25.2-150.7*3	26.7-159.7*3	28.0-168.0*3	29.5-177.0*3	30.9-185.2*3	32.5-195.0*3	33.8-202.5*3	
Power source			3-phase, 4-wire, 400 V, 50Hz										3-phase, 4-wire, 400 V, 50Hz											
Capacity	Cooling	kW	22.4	28.0	33.5	40.0	45.0	50.4	56.0	61.5	67.0	73.0	78.5	85.0	90.0	95.0	100.5	106.5	112.0	118.0	123.5	130.0	135.0	
	Nominal Heating		22.4	28.0	33.5	40.0	42.0	50.4	56.0	61.5	67.0	70.0	75.5	82.0	84.0	95.0	100.5	103.5	109.0	112.0	117.5	124.0	126.0	
	Max. Heating		25.0	31.5	37.5	45.0	48.0	56.5	63.0	69.0	75.0	79.5	85.5	93.0	96.0	106.5	112.5	117.0	123.0	127.5	133.5	141.0	144.0	
Input power	Cooling	kW	6.26	9.53	11.89	13.16	16.71	15.79	19.06	21.42	23.78	26.24	28.60	29.87	33.42	33.31	35.67	38.13	40.49	42.95	45.31	46.58	50.13	
	Nominal Heating		5.37	7.38	9.16	10.80	11.81	12.75	14.76	16.54	18.32	19.19	20.97	22.61	23.62	25.70	27.48	28.35	30.13	31.00	32.78	34.42	35.43	
	Max. Heating		6.25	8.96	11.61	13.95	14.98	15.21	17.92	20.44	22.96	23.94	26.46	28.93	29.96	31.92	34.44	35.42	38.92	41.44	43.91	44.94	49.94	
EER	Cooling	W/W	3.57	2.93	2.81	3.03	2.69	3.19	2.94	2.87	2.82	2.78	2.74	2.85	2.69	2.85	2.82	2.79	2.77	2.75	2.73	2.79	2.69	
	Nominal Heating		4.17	3.79	3.65	3.70	3.55	3.95	3.79	3.62	3.66	3.65	3.60	3.63	3.56	3.66	3.65	3.65	3.62	3.61	3.58	3.60	3.56	
	Max. Heating		4.00	3.51	3.26	3.22	3.20	3.71	3.52	3.38	3.27	3.32	3.23	3.21	3.20	3.34	3.27	3.30	3.24	3.28	3.22	3.21	3.20	
SEER	Cooling		7.16	6.61	6.73	6.76	6.27	6.89	6.61	6.67	6.73	6.44	6.50	6.52	6.27	6.69	6.73	6.54	6.58	6.38	6.42	6.43	6.27	
	Heating		3.78	3.76	3.86	4.31	4.41	3.77	3.76	3.81	3.86	4.09	4.14	4.36	4.41	3.83	3.86	4.01	4.04	4.19	4.23	4.38	4.41	
ηc	Cooling	%	283.0	261.0	266.0	267.0	248.0	272.0	261.0	263.5	266.0	254.5	257.0	257.5	248.0	264.3	266.0	258.3	260.0	252.3	254.0	254.3	248.0	
	Heating		148.0	147.0	151.0	169.0	173.0	147.5	147.0	149.0	151.0	160.0	162.0	171.0	173.0	149.7	151.0	157.0	158.3	164.3	165.7	171.7	173.0	
Air flow rate	High	m³/h	11,100	11,100	11,100	13,000	13,000	11,100*2	11,100*2	11,100*2	11,100*2	13,000+11,100	13,000+11,100	13,000*2	13,000*2	11,100*3	11,100*3	13,000+11,100*2	13,000+11,100*2	13,000*2+11,100	13,000*2+11,100	13,000*3	13,000*3	
Sound pressure level*/Power level	Cooling	dB(A)	56 / 77	58 / 78	59 / 79	60 / 82	61 / 82	60 / 81	61 / 81	62 / 82	62 / 82	63 / 83	63 / 84	64 / 85	64 / 85	63 / 83	64 / 84	64 / 85	65 / 85	65 / 86	65 / 86	65 / 87	66 / 87	
	Heating		58 / 79	59 / 79	63 / 82	62 / 83	63 / 83	62 / 82	64 / 84	66 / 85	66 / 85	64 / 84	66 / 86	66 / 86	67 / 86	67 / 86	68 / 87	68 / 87	68 / 87	68 / 87	68 / 87	68 / 87	68 / 88	68 / 88
Max. External static pressure		Pa	80	80	80	80	80	80	80	80	80	80	80	80	80	80	80	80	80	80	80	80	80	
Compressor motor output		kW	7.5	7.5	7.5	11.0	11.0	7.5 × 2	7.5 × 2	7.5 × 2	7.5 × 2	11.0 × 2	11.0 × 2	11.0 × 2	11.0 × 2	7.5 × 3	7.5 × 3	11.0 × 2 + 7.5	11.0 × 2 + 7.5	11.0 × 2 + 7.5	11.0 × 3	11.0 × 3	11.0 × 3	
Heat exchanger fin			Blue fin	Blue fin	Blue fin	Blue fin	Blue fin	Blue fin	Blue fin	Blue fin	Blue fin	Blue fin	Blue fin	Blue fin	Blue fin	Blue fin	Blue fin	Blue fin	Blue fin	Blue fin	Blue fin	Blue fin	Blue fin	
Net Dimensions	Height	mm	1,690	1,690	1,690	1,690	1,690	1,690	1,690	1,690	1,690	1,690	1,690	1,690	1,690	1,690	1,690	1,690	1,690	1,690	1,690	1,690	1,690	
	Width		930	930	930	1,240	1,240	930 × 2	930 × 2	930 × 2	930 × 2	1,240 + 930	1,240 + 930	1,240 × 2	1,240 × 2	930 × 3	930 × 3	1,240 + 930 × 2	1,240 + 930 × 2	1,240 × 2 + 930	1,240 × 2 + 930	1,240 × 3	1,240 × 3	
	Depth		765	765	765	765	765	765	765	765	765	765	765	765	765	765	765	765	765	765	765	765	765	
Weight		kg	262	262	262	286	286	262 × 2	262 × 2	262 × 2	286 + 262	286 + 262	286 × 2	286 × 2	262 × 3	262 × 3	286 + 262 × 2	286 + 262 × 2	286 × 2 + 262	286 × 2 + 262	286 × 3	286 × 3		
Refrigerant	Type (Global Warming Potential)		R410A (2,088)	R410A (2,088)	R410A (2,088)	R410A (2,088)	R410A (2,088)	R410A (2,088)	R410A (2,088)	R410A (2,088)	R410A (2,088)	R410A (2,088)	R410A (2,088)	R410A (2,088)	R410A (2,088)	R410A (2,088)	R410A (2,088)	R410A (2,088)	R410A (2,088)	R410A (2,088)	R410A (2,088)	R410A (2,088)	R410A (2,088)	
	Charge	kg (CO2eq-1)	11.8 (24.6)	11.8 (24.6)	11.8 (24.6)	11.8 (24.6)	11.8 (24.6)	11.8 × 2 (24.6 × 2)	11.8 × 2 (24.6 × 2)	11.8 × 2 (24.6 × 2)	11.8 × 2 (24.6 × 2)	11.8 × 2 (24.6 × 2)	11.8 × 2 (24.6 × 2)	11.8 × 2 (24.6 × 2)	11.8 × 3 (24.6 × 3)	11.8 × 3 (24.6 × 3)	11.8 × 3 (24.6 × 3)	11.8 × 3 (24.6 × 3)	11.8 × 3 (24.6 × 3)	11.8 × 3 (24.6 × 3)	11.8 × 3 (24.6 × 3)	11.8 × 3 (24.6 × 3)	11.8 × 3 (24.6 × 3)	
	Liquid	mm	12.70	12.70	12.70	12.70	12.70	15.88	15.88	15.88	15.88	15.88	15.88	15.88	19.05	19.05	19.05	19.05	19.05	19.05	19.05	19.05	19.05	
Connection pipe diameter	Discharge Gas	mm	15.88	19.05	19.05	22.22	22.22	22.22	22.22	22.22	28.58	28.58	28.58	28.58	28.58	28.58	28.58	34.92	34.92	34.92	34.92	34.92	34.92	
	Suction Gas		22.22	22.22	28.58	28.58	28.58	28.58	28.58	28.58	34.92	34.92	34.92	34.92	34.92	34.92	41.27	41.27	41.27	41.27	41.27	41.27	41.27	
	Operating Range		Cooling	-10 to 46	-10 to 46	-10 to 46	-10 to 46	-10 to 46	-10 to 46	-10 to 46	-10 to 46	-10 to 46	-10 to 46	-10 to 46	-10 to 46	-10 to 46	-10 to 46	-10 to 46	-10 to 46	-10 to 46	-10 to 46	-10 to 46	-10 to 46	-10 to 46
Operating Range	Heating	*CDB	-20 to 21	-20 to 21	-20 to 21	-20 to 21	-20 to 21	-20 to 21	-20 to 21	-20 to 21	-20 to 21	-20 to 21	-20 to 21	-20 to 21	-20 to 21	-20 to 21	-20 to 21	-20 to 21	-20 to 21	-20 to 21	-20 to 21	-20 to 21	-20 to 21	
	Cooling/Heating		-10 to 21	-10 to 21	-10 to 21	-10 to 21	-10 to 21	-10 to 21	-10 to 21	-10 to 21	-10 to 21	-10 to 21	-10 to 21	-10 to 21	-10 to 21	-10 to 21	-10 to 21	-10 to 21	-10 to 21	-10 to 21	-10 to 21	-10 to 21	-10 to 21	-10 to 21

Energy Efficiency Combination

Rated capacity range		HP	16	22	24	26	28	30	32	34	36	38	40	42	44	
Model name			AJH144GALDHH	AJH198GALDHH	AJH216GALDHH	AJH234GALDHH	AJH252GALDHH	AJH270GALDHH	AJH288GALDHH	AJH306GALDHH	AJH324GALDHH	AJH342GALDHH	AJH360GALDHH	AJH378GALDHH	AJH396GALDHH	
Unit 1 Unit 2 Unit 3			AJH072GALDH AJH072GALDH	AJH126GALDH AJH072GALDH	AJH072GALDH AJH072GALDH AJH072GALDH	AJH090GALDH AJH072GALDH AJH072GALDH	AJH090GALDH AJH090GALDH AJH072GALDH	AJH090GALDH AJH090GALDH AJH090GALDH	AJH126GALDH AJH090GALDH AJH090GALDH	AJH126GALDH AJH090GALDH AJH090GALDH	AJH126GALDH AJH126GALDH AJH072GALDH	AJH126GALDH AJH126GALDH AJH090GALDH	AJH126GALDH AJH126GALDH AJH090GALDH	AJH126GALDH AJH126GALDH AJH126GALDH	AJH126GALDH AJH126GALDH AJH126GALDH	
Maximum connectable indoor units*			34	47	52	56	60	64	64	64	64	64	64	64		
Connectable capacity range of indoor units		kW	11.2-67.2*3	15.6-93.6*3	16.8-100.8*3	18.2-109.2*3	19.6-117.6*3	21.0-126.0*3	22.6-135.6*3	24.0-144.0*3	25.6-153.6*3	27.0-162.0*3	28.3-169.5*3	30.0-180.0*3	31.3-187.5*3	
Power source			3-phase, 4-wire, 400 V, 50Hz							3-phase, 4-wire, 400 V, 50Hz						
Capacity	Cooling	kW	44.8	62.4	67.2	72.8	78.4	84.0	90.4	96.0	102.4	108.0	113.0	120.0	125.0	
	Nominal Heating		44.8	62.4	67.2	72.8	78.4	84.0	90.4	96.0	102.4	108.0	110.0	120.0	122.0	
	Max. Heating		50.0	70.0	75.0	81.5	88.0	94.5	101.5	108.0	115.0	121.5	124.5	135.0	138.0	
Input power	Cooling	kW	12.52	19.42	18.78	22.05	25.32	28.59	28.95	32.22	32.58	35.85	39.40	39.48	43.03	
	Nominal Heating		10.74	16.17	16.11	18.12	20.13	22.14	23.55	25.56	26.97	28.98	29.99	32.40	33.41	
	Max. Heating		12.50	20.20	18.75	21.46	24.17	26.88	29.16	31.87	34.15	36.86	37.89	41.85	42.88	
EER	Cooling	W/W	3.58	3.21	3.58	3.10	3.10	3.12	2.98	3.12	3.01	3.01	3.04	2.90	2.90	
	Nominal Heating		4.17	3.86	4.17	4.02	3.89	3.79	3.84	3.76	3.80	3.73	3.67	3.70	3.65	
	Max. Heating		4.00	3.47	4.00	3.80	3.64	3.52	3.48	3.39	3.37	3.30	3.29	3.23	3.22	
SEER	Cooling		7.16	6.96	7.16	6.98	6.79	6.61	6.84	6.61	6.71	6.89	6.75	6.60	6.60	



Heat Pump
Modular type

VRF V-IV

System configuration example

- Suitable for air conditioning midsize and large buildings. Connecting each outdoor unit makes it possible to create a high-capacity system.
- Multiple indoor units are connected with separation tubes and headers.

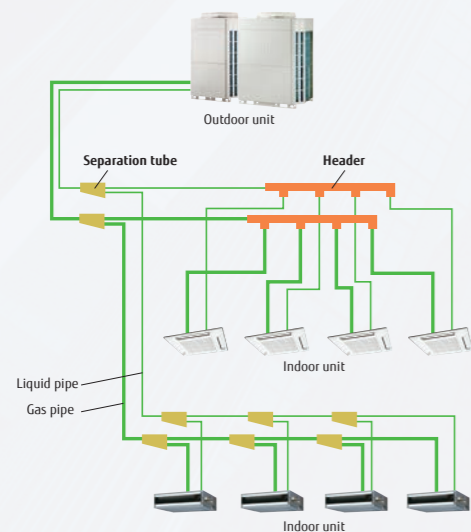

New intelligent refrigerant control

Fujitsu General is proposing outdoor units equipped with refrigerant control function. The refrigerant control operates with subtle control corresponding to the heat load of the room and offers a more comfortable environment. The refrigerant control can also provide increased energy savings.

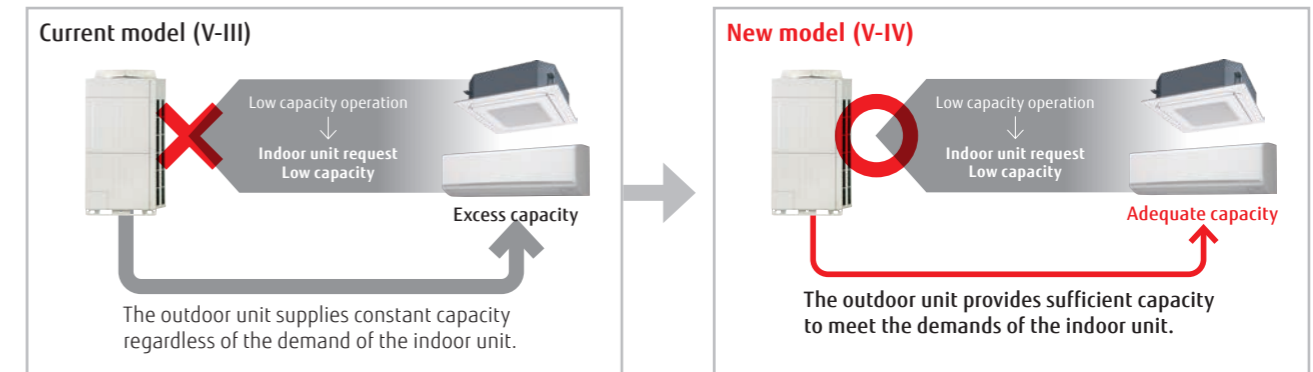

* The improvements due to the control and the actual sine wave vary depending on the combination of the indoor unit and system operating conditions.

Efficiency in actual operating conditions

The use of our proprietary heat exchanger structure and high-efficiency DC twin-rotary compressors achieves the class-leading coefficient of performance (COP) in every combination.

Space saving combination

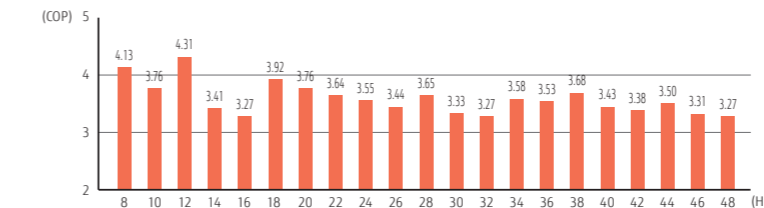

Energy efficiency combination

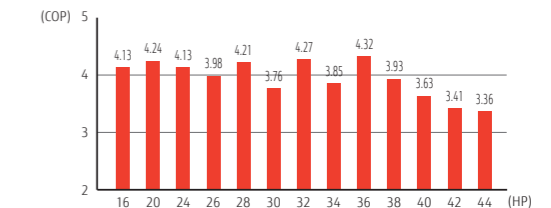

* These specifications are determined by Cassette combination. *Multiple outdoor units are not certified by Eurovent.

The energy-saving technology that boosted operation efficiency

- Powerful large propeller fan**
The fan uses CFD* technology to achieve both high performance and low noise operation. *CFD: Computational Fluid Dynamics
- 3-phase DC fan motor**
The use of a DC fan motor with sophisticated driver control improves energy efficiency substantially. In addition, low noise is realized by the DC fan motor.
- Sine-wave DC inverter control**
High-efficiency is realized by the adoption of reduced switching loss IPM.
- 4-face heat exchanger**
The 4-face heat exchanger increases the effective surface area and significantly improves heat-exchanging efficiency.
- Subcooling heat exchanger**
High heat exchange efficiency is achieved by using an internal projection-shape double-pipe construction.
- High-efficient, large-capacity DC twin-rotary compressor**
Large-capacity high-efficient DC twin-rotary compressor with excellent intermediate capability.
- Front intake port (Corner cut air inlet structure)**
In multiple outdoor unit installations, the unique front intake design improves airflow into the heat exchanger.

Outdoor units lineup• Combinations other than those listed below are not recommended.

Space saving combination

22.4 kW (8 HP) AJH072LALDH UNIT: AJH072LALDH	28.0 kW (10 HP) AJH090LALDH UNIT: AJH090LALDH	33.5 kW (12 HP) AJH108LALDH UNIT: AJH108LALDH	40.0 kW (14 HP) AJH126LALDH UNIT: AJH126LALDH	45.0 kW (16 HP) AJH144LALDH UNIT: AJH144LALDH
50.4 kW (18 HP) AJH162LALDH UNIT: AJH090/072LALDH	56.0 kW (20 HP) AJH180LALDH UNIT: AJH090/090LALDH	62.4 kW (22 HP) AJH198LALDH UNIT: AJH126/072LALDH	68.0 kW (24 HP) AJH216LALDH UNIT: AJH126/090LALDH	73.0 kW (26 HP) AJH234LALDH UNIT: AJH144/090LALDH
78.5 kW (28 HP) AJH252LALDH UNIT: AJH144/108LALDH	85.0 kW (30 HP) AJH270LALDH UNIT: AJH144/126LALDH	90.0 kW (32 HP) AJH288LALDH UNIT: AJH144/144LALDH	95.4 kW (34 HP) AJH306LALDH UNIT: AJH144/090/072LALDH	101.0 kW (36 HP) AJH324LALDH UNIT: AJH144/090/090LALDH
106.5 kW (38 HP) AJH342LALDH UNIT: AJH144/108/090LALDH	113.0 kW (40 HP) AJH360LALDH UNIT: AJH144/126/090LALDH	118.0 kW (42 HP) AJH378LALDH UNIT: AJH144/144/090LALDH	123.5 kW (44 HP) AJH396LALDH UNIT: AJH144/144/108LALDH	130.0 kW (46 HP) AJH414LALDH UNIT: AJH144/144/126LALDH
135.0 kW (48 HP) AJH432LALDH UNIT: AJH144/144/144LALDH				

Energy efficiency combination

44.8 kW (16 HP) AJH144LALDHH UNIT: AJH072/072LALDH	55.9 kW (20 HP) AJH180LALDHH UNIT: AJH108/072LALDH	67.2 kW (24 HP) AJH216LALDHH UNIT: AJH072/072/072LALDH	72.8 kW (26 HP) AJH234LALDHH UNIT: AJH090/072/072LALDH	78.3 kW (28 HP) AJH252LALDHH UNIT: AJH108/072/072LALDH
84.8 kW (30 HP) AJH270LALDHH UNIT: AJH126/072/072LALDH	89.4 kW (32 HP) AJH288LALDHH UNIT: AJH108/108/072LALDH	95.9 kW (34 HP) AJH306LALDHH UNIT: AJH126/108/072LALDH	100.5 kW (36 HP) AJH324LALDHH UNIT: AJH108/108/108LALDH	107.0 kW (38 HP) AJH342LALDHH UNIT: AJH126/108/108LALDH
113.5 kW (40 HP) AJH360LALDHH UNIT: AJH126/126/108LALDH	120.0 kW (42 HP) AJH378LALDHH UNIT: AJH126/126/126LALDH	125.0 kW (44 HP) AJH396LALDHH UNIT: AJH144/126/126LALDH		

8, 10 HP: AJH072LALDH / AJH090LALDH
12, 14, 16 HP: AJH108LALDH / AJH126LALDH / AJH144LALDH



8, 10 HP

12, 14, 16 HP

Dimensions

(Unit: mm)

8, 10 HP

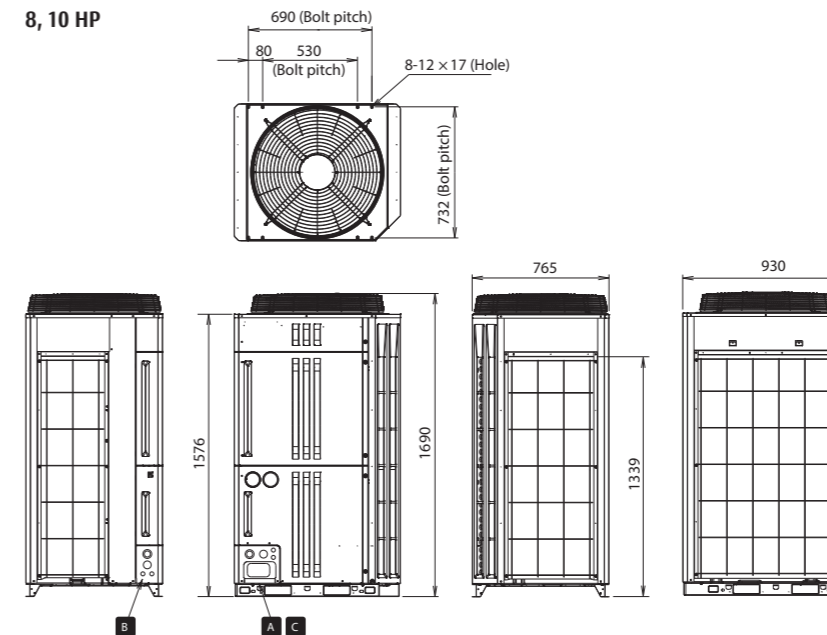

12, 14, 16 HP

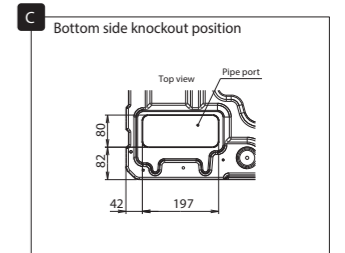
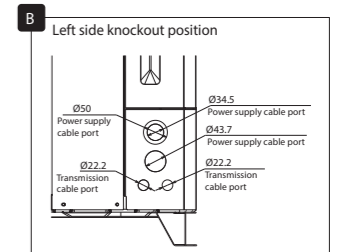
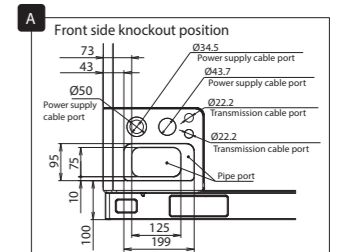
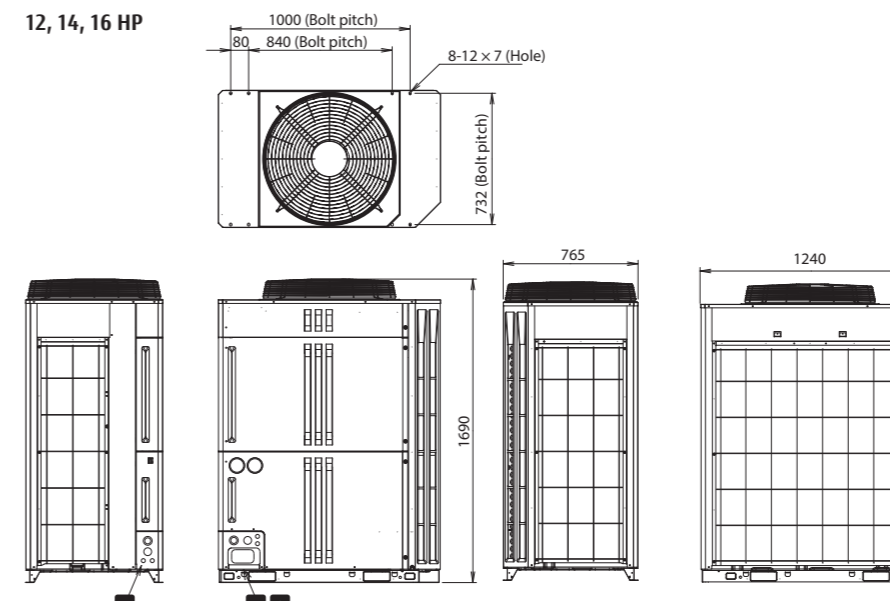

VRF INDOOR UNITS

17 types and 95 models available to meet the requirements of any building design.







Indoor units for the VRF Systems are compact, highly efficient, quiet, and user-friendly. Fujitsu General offers a variety of types and capacities for its indoor units that are easy to install and maintain. In addition, a variety of optional parts are available to provide an even more desirable air conditioning experience to users.

- V-058 VRF Indoor Unit Lineup for J-VS
- V-060 Compact Cassette Grid type
- V-062 Low Static Pressure Duct Slim Duct/Slim Concealed Floor
- V-064 Wall-mounted type

- V-066 VRF Indoor Unit Lineup for J-IVS, J-IV, J-IVL, VR-IV, V-IV
- V-068 Compact Cassette Grid type
- V-070 Cassette Slim type Circular Flow
- V-072 Cassette Large type Circular Flow
- V-074 Cassette One-way Flow type
- V-076 3D Flow Cassette
- V-078 Low Static Pressure Duct Mini Duct
- V-080 Low Static Pressure Duct Slim Duct/Slim Concealed Floor
- V-082 Low Static Pressure Duct
- V-084 Medium Static Pressure Duct
- V-086 High Static Pressure Duct
- V-088 Compact Floor
- V-090 Floor/Ceiling
- V-092 Ceiling
- V-094 Wall-mounted (EEV Internal/external)

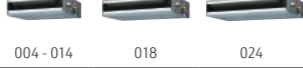

VRF Indoor Unit Lineup for J-VS

Capacity range (kW)			1.1	1.7	2.2	2.8	3.6	4.0	4.5	5.6	7.1
Class			4	5	7	9	12	14	14	18	24
Cassette	Compact type	Compact Grid type/Standard type 	AUXB004HLAH	AUXB005HLAH	AUXB007HLAH	AUXB009HLAH	AUXB012HLAH		AUXB014HLAH	AUXB018HLAH	
		High Efficiency*1 				AUXN009HLAH	AUXN012HLAH		AUXN014HLAH		
Duct	Low Static Pressure Duct	Slim Duct (With drain pump)  004 - 014 018 024	ARXD004HLAH	ARXD005HLAH	ARXD007HLAH	ARXD009HLAH	ARXD012HLAH		ARXD014HLAH	ARXD018HLAH	ARXD024HLAH
		High Efficiency*1  009 - 014				ARXP009HLAH	ARXP012HLAH		ARXP014HLAH		
Wall-mounted type	Wall-mounted type	Wall-mounted type  004 - 014	ASHA004HCAH	ASHA005HCAH	ASHA007HCAH	ASHA009HCAH	ASHA012HCAH	ASHA014HCAH			
		Wall-mounted type (EEV external)  004 - 014	ASHE004HCAH	ASHE005HCAH	ASHE007HCAH	ASHE009HCAH	ASHE012HCAH	ASHE014HCAH			
			This model requires the EV kit to be connected.			This model requires the EV kit to be connected.					

*1: Production by order
 Specifications and design are subject to change without notice.
 *Products other than ducts can be connected to J-IV, J-IVS, J-IVL, V-IV, VR-IV

Compact Cassette Grid type



Compact and stylish panel

The compact and stylish panel fits nicely into a grid type ceiling. The linear design is a perfect fit into a grid of 620 mm × 620 mm in the ceiling.

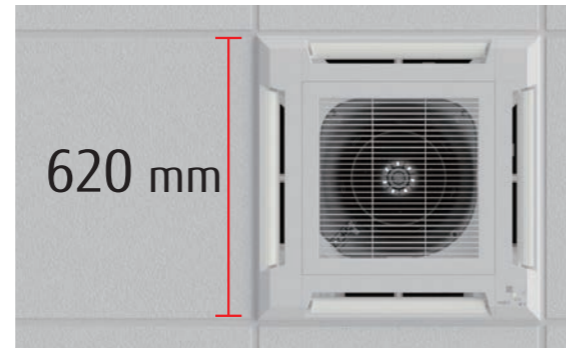

Easy maintenance

You can access the unit for maintenance just by removing a ceiling panel right next to the grille. As no inspection hole needs to be cut through the ceiling, no additional construction cost is incurred.



The air inlet grille can be installed to open in any direction for easy maintenance.



Flexible installation

The unit fits nicely into the decor of a grid type ceiling and can be installed near a lighting or a ventilation opening.



High ceiling mode

The cassette can be installed up to a height of 3.0 m. (012/014/018).

Model code	Maximum height from floor to ceiling (m)	
	Standard mode	High ceiling mode
004	2.7	-
005	2.7	-
007	2.7	-
009	2.7	-
012	2.7	3.0
014	2.7	3.0
018	2.7	3.0

Model: AUXB004HLAH / AUXB005HLAH / AUXB007HLAH / AUXB009HLAH
 AUXB012HLAH / AUXB014HLAH / AUXB018HLAH
 AUXN009HLAH / AUXN012HLAH / AUXN014HLAH * Production by order



Specifications

Model name		AUXB004HLAH	AUXB005HLAH	AUXB007HLAH	AUXB009HLAH	AUXB012HLAH	AUXB014HLAH	AUXB018HLAH	AUXN009HLAH	AUXN012HLAH	AUXN014HLAH
Power source		Single phase, 220-240V, 50Hz						Single phase, 220-240V, 50Hz			
Capacity	Cooling	1.1	1.7	2.2	2.8	3.6	4.5	5.6	2.8	3.6	4.5
	Heating	1.3	1.9	2.8	3.2	4.1	5.0	6.3	3.2	4.1	5.0
Input power		21	21	23	24	27	33	50	41	71	81
Airflow rate (Cooling / Heating)*	High	530	530	540	550	600	680	820	750	970	1,030
	Med-High	490 / 480	490 / 480	500	520	560	620	660	550	600	680
	Med	450 / 430	450 / 430	460	480	520	560	590	480	520	560
	Med-Low	420 / 380	420 / 380	420	440	480	500	520	440	480	500
	Low	390 / 340	390 / 340	390	400	430	440	460	400	430	440
Quiet	350 / 300	350 / 300	350	350	390	390	400	350	390	390	
Sound pressure level (Cooling / Heating)*	High	34	34	34	35	37	39	45	42	49	50
	Med-High	32 / 31	32 / 31	32	33	34	37	39	35	37	39
	Med	30 / 29	30 / 29	30	31	33	34	36	31	33	34
	Med-Low	28 / 26	28 / 26	28	29	31	32	33	29	31	32
	Low	27 / 24	27 / 24	27	27	29	30	30	27	29	30
Quiet	25 / 21	25 / 21	25	25	27	27	27	25	27	27	
Net Dimensions (H × W × D)		mm 245 × 570 × 570						mm 245 × 570 × 570			
Weight		14.5	14.5	15	15	15.5	15.5	17	15	15.5	15.5
Connection pipe diameter	Liquid (Flare)	6.35	6.35	6.35	6.35	6.35	6.35	6.35	6.35	6.35	6.35
	Gas (Flare)	9.52	9.52	9.52	9.52	12.70	12.70	12.70	9.52	12.70	12.70
Drain Hose Diameter (I.D./O.D.)		25 / 32	25 / 32	25 / 32	25 / 32	25 / 32	25 / 32	25 / 32	25 / 32	25 / 32	25 / 32
Cassette Grille	Model name	UTG-UFGH-W						UTG-UFGH-W			
	Net Dimensions (H × W × D)	mm 49 × 620 × 620						mm 49 × 620 × 620			
	Weight	2.3	2.3	2.3	2.3	2.3	2.3	2.3	2.3	2.3	2.3

Note: Specifications are subject to the following conditions:
 Cooling: Indoor temperature of 27°CDB/19°CWB, and outdoor temperature of 35°CDB/24°CWB.
 Heating: Indoor temperature of 20°CDB/(15°CWB), and outdoor temperature of 7°CDB/6°CWB.
 Pipe length: 7.5 m; Height difference between outdoor unit and indoor unit: 0 m. Voltage: 230 [V]
 *The value is the same for cooling and heating if there is one value.

Optional parts

*For more details, please refer to the chapter "Optional parts".

- Wireless remote controller: UTY-LNVG
- Flesh Air Intake Kit: UTZ-VXAA
- Insulation kit for high humidity: UTZ-KXGC
- Silver Ion Filter: UTD-HFAA
- Remote sensor kit: UTY-XSZXZ1
- Cassette Grille: UTG-UFGH-W
- External power supply unit: UTZ-GXXD
- WLAN adapter: UTY-TFSXZ1, UTY-TFSXJ3, FG-AC-WIFI21
- Gas sensor kit: UTY-SGZH
- Expansion kit: UTZ-JXXA
- Air Outlet Shutter Plate: UTR-YDZB

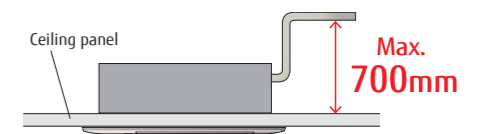

Dimensions

(Unit: mm)

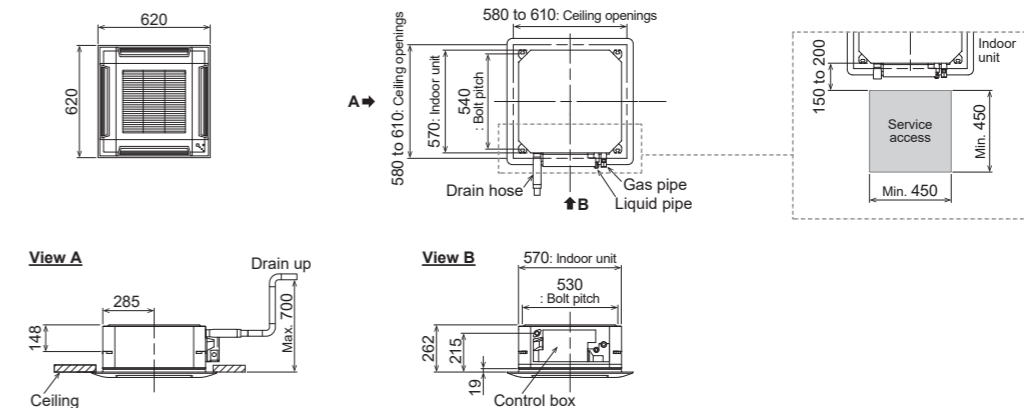

Low Static Pressure Duct Slim Duct



Slim design

Slim design allows for installation in a tight ceiling space.

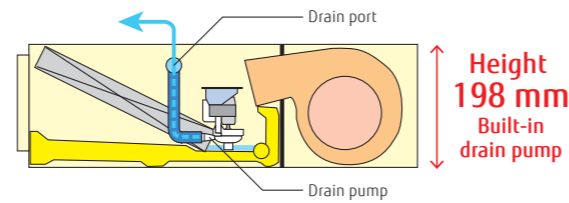

Air intake

Air intake direction can be selected to match the installation site.

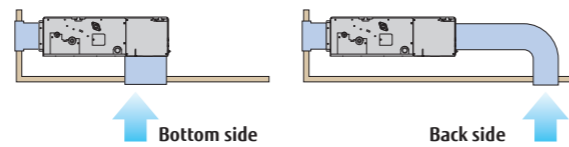

Wide range of static pressures

The use of a DC fan motor makes it possible to adjust the static pressure between 0 and 90 Pa. The static pressure range can be changed by a remote controller.



Static pressure range
0 to 90 Pa

* 024 model static pressure range is 0 to 50 Pa.

Auto louver grille kit (Option)

The optional clean-looking flat Auto louver blends into any interior and provides a comfortable airflow.



Filter (Accessory)

ARXD004-018

ARXD024

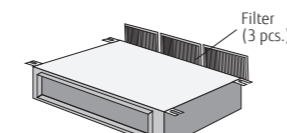
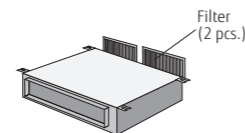

Model: ARXD004HLAH / ARXD005HLAH / ARXD007HLAH / ARXD009HLAH
ARXD012HLAH / ARXD014HLAH / ARXD018HLAH / ARXD024HLAH
ARXP009HLAH / ARXP012HLAH / ARXP014HLAH * Production by order

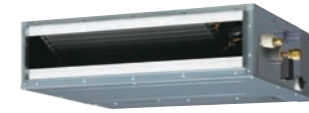

ARXD004/005/007/009/012/014HLAH
ARXP009/012/014HLAH

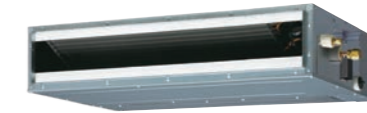

ARXX018HLAH

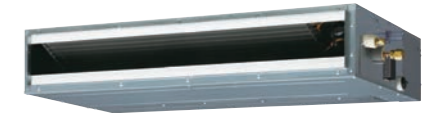

ARXD024HLAH

Specifications

Model name	ARXD004HLAH	ARXD005HLAH	ARXD007HLAH	ARXD009HLAH	ARXD012HLAH	ARXD014HLAH	ARXD018HLAH	ARXD024HLAH	ARXP009HLAH	ARXP012HLAH	ARXP014HLAH		
Power source	Single phase, 220-240V, 50Hz						Single phase, 220-240V, 50Hz						
Capacity	Cooling	1.1	1.7	2.2	2.8	3.6	4.5	5.6	7.1	2.8	3.6	4.5	
	Heating	1.3	1.9	2.8	3.2	4.0	5.0	6.3	8.0	3.2	4.0	5.0	
Input power	W	38	38	41	47	48	84	76	107	77	128	128	
Airflow rate	High	530	530	550	600	580	790	930	1,250	770	940	940	
	Med-High	480	480	520	550	550	720	880	1,180	630	810	810	
	Med	440	440	480	500	520	640	780	1,060	530	660	660	
	Med-Low	410	410	450	460	480	560	670	930	480	580	580	
	Low	370	370	400	400	430	470	580	810	430	490	490	
Quiet	320	320	360	360	350	370	510	640	380	390	390		
Static pressure range	Pa	0 to 90	0 to 90	0 to 90	0 to 90	0 to 90	0 to 90	0 to 50	0 to 25	0 to 25	0 to 25		
Standard static pressure		25	25	25	25	25	25	25	25	25	25		
Sound pressure level	High	26	26	28	29	30	34	34	35	36	40	40	
	Med-High	26	26	26	27	28	32	31	32	32	38	38	
	Med	25	25	25	25	27	30	29	30	28	33	33	
	Med-Low	24	24	24	24	26	28	27	27	27	31	31	
	Low	22	22	22	22	24	25	25	24	25	27	27	
Quiet	21	21	21	21	22	22	23	21	23	24	24		
Net Dimensions (H × W × D)	mm	198 × 700 × 620						198 × 900 × 620		198 × 1,100 × 620		198 × 700 × 620	
Weight	kg	16	16	16.5	16.5	17	17	21	25	16.5	17	17	
Connection pipe diameter	Liquid (Flare)	6.35	6.35	6.35	6.35	6.35	6.35	9.52	6.35	6.35	6.35		
	Gas (Flare)	9.52	9.52	9.52	9.52	12.70	12.70	12.70	15.88	9.52	12.70	12.70	
Drain Hose Diameter (I.D./O.D.)		25/32	25/32	25/32	25/32	25/32	25/32	25/32	25/32	25/32	25/32		

Note: Specifications are subject to the following conditions:
Cooling: Indoor temperature of 27°CDB/19°CWB, and outdoor temperature of 35°CDB/24°CWB.
Heating: Indoor temperature of 20°CDB/15°CWB, and outdoor temperature of 7°CDB/6°CWB.
Pipe length: 7.5 m; Height difference between outdoor unit and indoor unit: 0 m. Voltage: 230 [V]
*1: This value is under cooling operation.

Optional parts

*For more details, please refer to the chapter "Optional parts".

- Wireless remote controller: UTY-LNVG*
- Remote sensor unit: UTY-XSZXZ1
- IR receiver unit: UTY-TRHX
- WLAN adapter: UTY-TFSXJ3, UTY-TFSXZ1, FG-AC-WIF1Z1
- External power supply unit: UTZ-GXXD
- Expansion kit: UTZ-JXXA
- Auto Louver Grille Kit: UTD-GXTA-W (004-014), UTD-GXTB-W (018)
- Silver Ion Filter: UTD-GXTC-W (024), UTD-HFTA (004-014), UTD-HFTB (018), UTD-HFTC (024)
- Gas sensor kit: UTY-SGZH

*IR receiver unit (UTY-TRHX) is required.

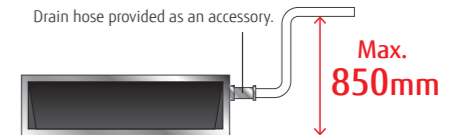

Dimensions

(Unit: mm)

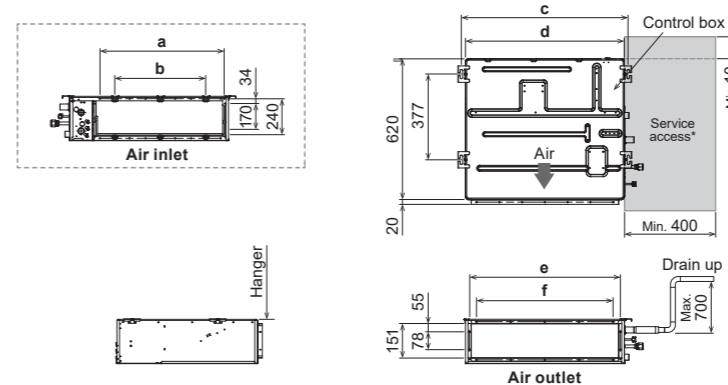

	ARXD004-014HLAH	ARXD018HLAH	ARXD024HLAH
a	574	774	974
b	P200×2=400	P200×3=600	P200×4=800
c	734	934	1,134
d	700	900	1,100
e	650	850	1,050
f	P100×6=600	P100×8=800	P100×10=1,000

*The design of the service access depends on the installation method. Refer to the installation manual for more information.

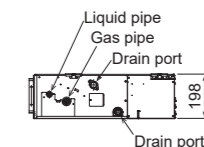

Wall-mounted type



Highly-efficiency, compact design

The 004-014 models share the same design. The high-density and large heat exchanger achieves a highly-efficiency and compact design. The compact body blends in well with conference rooms and offices, providing comfortable air conditioning.

High-density heat exchanger

Slim tube design: 5 mm
Greater heat-exchanging capacity is achieved through the use of a high-density heat exchanger and a sub-heat exchanger.

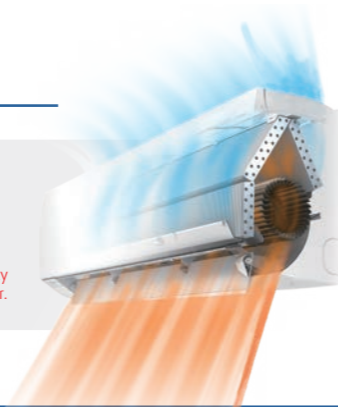

More comfortable airflow

The unique power diffuser provides comfortable air conditioning.

Heating

The vertical airflow provides powerful floor-level heating.

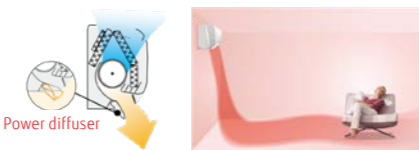

Cooling

The left/right airflow avoids blowing cool air directly at the occupants in a room.



Quiet operation & 6-Step fan speed control

The airflow pattern achieves significant noise reduction. Multistep airflow adjustment to suit the environment

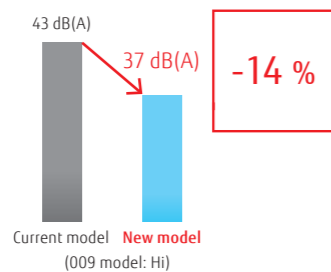

- 6-Step Speed
- High
- Med-High
- Med
- Med-Low
- Low
- Quiet

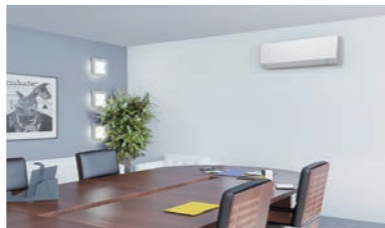

* Remote controller is compatible with the following:
UTY-RNRGZ5 / UTY-RLRG / UTY-RSRG / UTY-RHRG / UTY-DCGGZ3 / UTY-ALGXZ1 / UTY-APGXZ1

The Occupancy sensor contributes to further energy savings.

Energy saving operation starts automatically by detecting the motion of a person. Two modes of save operation mode and stop mode can be selected.

*If you want to use the Occupancy sensor control function, you need an setting device that can set the Occupancy sensor control function. For example: Wired RC (Touch panel).

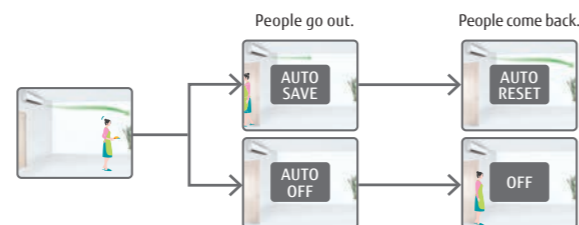

Model: ASHA004HCAH / ASHA005HCAH / ASHA007HCAH / ASHA009HCAH / ASHA012HCAH / ASHA014HCAH
[external EEV]
ASHE004HCAH / ASHE005HCAH / ASHE007HCAH / ASHE009HCAH / ASHE012HCAH / ASHE014HCAH



Specifications

Model name	ASHA004HCAH	ASHA005HCAH	ASHA007HCAH	ASHA009HCAH	ASHA012HCAH	ASHA014HCAH	ASHE004HCAH	ASHE005HCAH	ASHE007HCAH	ASHE009HCAH	ASHE012HCAH	ASHE014HCAH	
Power source	Single phase, 220-240V, 50Hz						Single phase, 220-240V, 50Hz						
Capacity	Cooling	1.1	1.7	2.2	2.8	3.6	4.0	1.1	1.7	2.2	2.8	3.6	4.0
	Heating	1.3	1.9	2.8	3.2	4.0	4.5	1.3	1.9	2.8	3.2	4.0	4.5
Input power	W	12	12	16	19	25	35	12	12	16	19	25	35
Airflow rate	High	450	450	550	590	660	770	450	450	550	590	660	770
	Med-High	430	430	490	550	590	710	430	430	490	550	590	710
	Med	400	400	450	490	550	650	400	400	450	490	550	650
	Med-Low	380	380	390	420	510	590	380	380	390	420	510	590
	Low	360	360	360	360	450	530	360	360	360	360	450	530
Sound pressure level	Quiet	310	310	320	320	320	320	310	310	320	320	320	320
	High	31	31	34	37	40	44	31	31	34	37	40	44
	Med-High	30	30	32	34	37	42	30	30	32	34	37	42
	Med	28	28	30	32	34	40	28	28	30	32	34	40
	Med-Low	27	27	28	29	33	37	27	27	28	29	33	37
Low	26	26	26	26	30	34	26	26	26	26	30	34	
Quiet	22	22	22	22	22	22	22	22	22	22	22	22	
Net Dimensions (H × W × D)	mm	268 × 840 × 203						268 × 840 × 203					
Weight	kg	8	8	8.5	8.5	8.5	8.5	8	8	8.5	8.5	8.5	8.5
Connection pipe diameter	Liquid (Flare)	6.35	6.35	6.35	6.35	6.35	6.35	6.35	6.35	6.35	6.35	6.35	6.35
	Gas (Flare)	9.52	9.52	9.52	9.52	12.70	12.70	9.52	9.52	9.52	9.52	12.70	12.70
Drain Hose Diameter (I.D./O.D.)		13.8/15.8 to16.7						13.8/15.8 to16.7					
EV kit (optional)		-	-	-	-	-	-	UTR-EV09XC			UTR-EV14XC		

Note: Specifications are subject to the following conditions:
Cooling: Indoor temperature of 27°CDB/19°CWB, and outdoor temperature of 35°CDB/24°CWB.
Heating: Indoor temperature of 20°CDB/15°CWB, and outdoor temperature of 7°CDB/6°CWB.
Pipe length: 7.5 m; Height difference between outdoor unit and indoor unit: 0 m. Voltage: 230 [V]
When connecting ASH*004G**H, ASH*007G**H, ASH*009G**H to an outdoor unit other than the outdoor unit of the J-IVL Series, the gas pipe diameter should be Ø12.70 mm.

Optional parts

- Wireless remote controller: UTY-LNVG
- External power supply unit: UTZ-GXXD
- WLAN adapter: UTY-TFSXZ1, UTY-TFSXJ3, FG-AC-WIF1Z1
- Silver Ion Filter: UTR-FA16-5
- Remote sensor kit: UTY-XSZXZ1
- Gas sensor kit: UTY-SGZH
- Expansion kit: UTZ-JXXA

Dimensions

(Unit: mm)

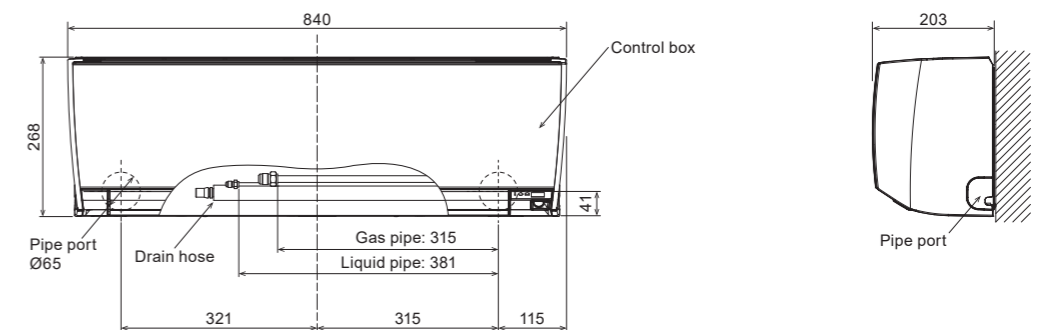

VRF Indoor Unit Lineup for J-IVS J-IV J-IVL VR-IV V-IV

Capacity range (kW)			1.1	2.2	2.8	3.6		4.0	4.5	5.6	7.1	9.0	10.0	11.2	12.5	14.0	18.0	22.4	25.0	28.0		
Class			4	7	9	12		14	14	18	24	30	34	36	45	54	60	72	90	96		
Cassette	Compact type	Compact Grid type/Standard type	AUXB 004 GLEH	AUXB 007 GLEH	AUXB 009 GLEH	AUXB 012 GLEH			AUXB 014 GLEH	AUXB 018 GLEH	AUXB 024 GLEH											
	Slim type	Circular Flow								AUXM 018 GLEH	AUXM 024 GLEH	AUXM 030 GLEH										
	Large type	Circular Flow								AUXK 018 GLEH	AUXK 024 GLEH	AUXK 030 GLEH	AUXK 034 GLEH	AUXK 036 GLEH	AUXK 045 GLEH	AUXK 054 GLEH						
	One-way Flow type	One-way Flow	004 - 012 014 - 024	AUXV 004 GLEH	AUXV 007 GLEH	AUXV 009 GLEH	AUXV 012 GLEH		AUXV 014 GLEH	AUXV 018 GLEH	AUXV 024 GLEH											
	3D Flow type	3D Flow								AUXS 018 GLEH	AUXS 024 GLEH											
Duct	Low Static Pressure Duct	Mini Duct (With drain pump)	004 - 014 018 024	ARXK 004 GLGH	ARXK 007 GLGH	ARXK 009 GLGH	ARXK 012 GLGH		ARXK 014 GLGH	ARXK 018 GLGH	ARXK 024 GLGH											
		Slim Duct (With drain pump)	04/007 - 014 018 024	ARXD 04 GALH*2	ARXD 007 GLEH	ARXD 009 GLEH	ARXD 012 GLEH		ARXD 014 GLEH	ARXD 018 GLEH	ARXD 024 GLEH											
		High Efficiency*3								ARXP 018 GLFH		ARXP 030 GLFH										
	Medium static pressure duct	Normal									ARXA 024 GLEH	ARXA 030 GLEH		ARXA 036 GLEH	ARXA 045 GLEH							
		High Static Pressure Duct	Normal	036/45 - 60 072 - 090 096											ARXC 036 GTEH	ARXC 045 GTEH		ARXC 060 GTEH*1	ARXC 072 GTEH*1	ARXC 090 GTEH*1	ARXC 096 GTEH*1	
Floor	Floor (*Same as Ceiling models)					ABHA 012 GTEH			ABHA 014 GTEH	ABHA 018 GTEH	ABHA 024 GTEH											
	Slim Concealed Floor (*Same as Slim Duct models)	04/007 - 014 018 024	ARXD 04 GALH*2	ARXD 007 GLEH	ARXD 009 GLEH	ARXD 012 GLEH		ARXD 014 GLEH	ARXD 018 GLEH	ARXD 024 GLEH												
	Compact Floor		AGHA 004 GCGH	AGHA 007 GCGH	AGHA 009 GCGH	AGHA 012 GCGH		AGHA 014 GCGH														
	Compact Floor (EEV external)		AGHE 004 GCEH	AGHE 007 GCEH	AGHE 009 GCEH	AGHE 012 GCEH		AGHE 014 GCEH														
			This model requires the EV kit to be connected.																			
Ceiling		012 - 024 030 - 054				ABHA 012 GTEH			ABHA 014 GTEH	ABHA 018 GTEH	ABHA 024 GTEH	ABHA 030 GTEH		ABHA 036 GTEH	ABHA 045 GTEH	ABHA 054 GTEH						
Wall-mounted type	Wall-mounted type	004 - 014 18 - 24 030 - 034	ASHA 004 GCGH	ASHA 007 GCGH	ASHA 009 GCGH	ASHA 012 GCGH		ASHA 014 GCGH		ASHA 18 GBCH	ASHA 24 GBCH	ASHA 030 GTEH	ASHA 034 GTEH									
	Wall-mounted type (EEV external)	004 - 014	ASHE 004 GCEH	ASHE 007 GCEH	ASHE 009 GCEH	ASHE 012 GCEH		ASHE 014 GCEH														
			This model requires the EV kit to be connected.																			

*1: ARXC060/072/090/096G cannot be connected to J-IVS/J-IV Series.
 *2: ARXD04GALH cannot be connected to J-IVS/J-IVL/VR-IV Series.
 *3: Production by order
 Specifications and design are subject to change without notice.

Compact Cassette Grid type



Compact and stylish panel

The compact and stylish panel fits nicely into a grid type ceiling. The linear design is a perfect fit into a grid of 620 mm × 620 mm in the ceiling.

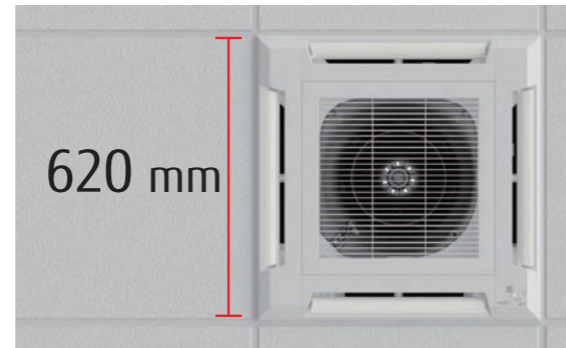

Easy maintenance

You can access the unit for maintenance just by removing a ceiling panel right next to the grille. As no inspection hole needs to be cut through the ceiling, no additional construction cost is incurred.



The air inlet grille can be installed to open in any direction for easy maintenance.



Flexible installation

The unit fits nicely into the decor of a grid type ceiling and can be installed near a lighting or a ventilation opening.



High ceiling mode

The cassette can be installed up to a height of 3.0 m. (012/014/018/024).

Model code	Maximum height from floor to ceiling (m)	
	Standard mode	High ceiling mode
004	2.7	-
007	2.7	-
009	2.7	-
012	2.7	3.0
014	2.7	3.0
018	2.7	3.0
024	2.7	3.0

Model: AUXB004GLEH / AUXB007GLEH / AUXB009GLEH
AUXB012GLEH / AUXB014GLEH / AUXB018GLEH
AUXB024GLEH



Specifications

Model name		AUXB004GLEH	AUXB007GLEH	AUXB009GLEH	AUXB012GLEH	AUXB014GLEH	AUXB018GLEH	AUXB024GLEH
Power source		Single phase, ~230 V, 50 Hz						
Capacity	Cooling	1.1	2.2	2.8	3.6	4.5	5.6	7.1
	Heating	1.3	2.8	3.2	4.1	5.0	6.3	8.0
Input power		23	25	25	29	35	36	84
Airflow rate	High	530/530	540	550	600	680	710	1,030
	Med-High	490/480	500	520	560	620	660	910
	Med	450/430	460	480	520	560	590	790
	Med-Low	420/380	420	440	480	500	520	680
	Low	390/340	390	400	430	440	460	560
	Quiet	350/300	350	350	390	390	400	450
Sound pressure level	High	34/34	34	35	37	38	41	50
	Med-High	32/31	32	33	34	37	39	46
	Med	30/29	30	31	33	34	36	43
	Med-Low	28/26	28	29	31	32	33	39
	Low	27/24	27	27	29	30	30	35
	Quiet	25/21	25	25	27	27	27	30
Net Dimensions (H × W × D)		mm	245 × 570 × 570	245 × 570 × 570	245 × 570 × 570	245 × 570 × 570	245 × 570 × 570	245 × 570 × 570
Weight		kg	14.5	15	15	15	17	17
Connection pipe diameter	Liquid (Flare)	mm	6.35	6.35	6.35	6.35	6.35	9.52
	Gas (Flare)	mm	9.52	9.52	9.52	12.70	12.70	15.88
Drain Hose Diameter (I.D./O.D.)			25/32					
Cassette Grille		Model name	UTG-UFGE-W/UTG-UFGC-W					
		Net Dimensions (H × W × D)	mm					
		Weight	kg					

Note: Specifications are subject to the following conditions:
Cooling: Indoor temperature of 27°CDB/19°CWB, and outdoor temperature of 35°CDB/24°CWB.
Heating: Indoor temperature of 20°CDB/(15°CWB), and outdoor temperature of 7°CDB/6°CWB.
Pipe length: 7.5 m; Height difference between outdoor unit and indoor unit: 0 m. Voltage: 230 [V]
*1: This value is under cooling operation.

Optional parts

*For more details, please refer to the chapter "Optional parts".

Air Outlet Shutter Plate:	UTR-YDZB	Cassette Grille:	UTG-UFGE-W, UTG-UFGC-W
Fresh Air Intake Kit:	UTZ-VXAA	External power supply unit:	UTZ-GXXA, UTZ-GXXC*
Insulation kit for high humidity:	UTZ-KXGC	WLAN adapter:	UTY-TFSXZ1, UTY-TFSXJ3, FG-AC-WIFI21
Silver Ion Filter:	UTD-HFAA		
Remote sensor kit:	UTY-XSZXZ1		

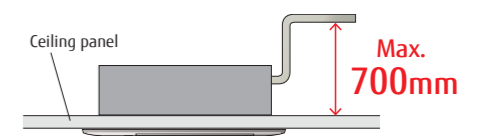

Dimensions

(Unit: mm)

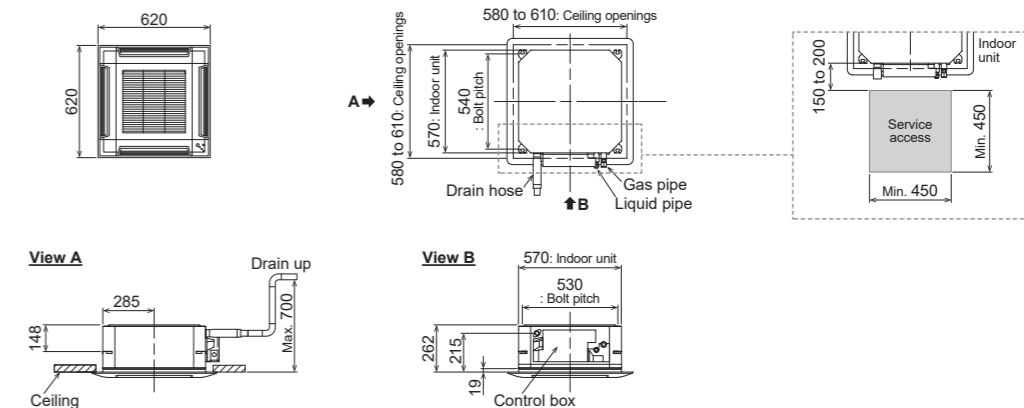

Cassette Slim type Circular Flow



Unique circular flow design

This Cassette type air conditioner is equipped with a high performance DC fan motor, a turbo fan, and a louver to propel powerful airflows in all directions.

- Ø7 mm high-density heat exchanger
- New DC fan motor
- High-efficiency turbo fan
- Seamless airflow louver

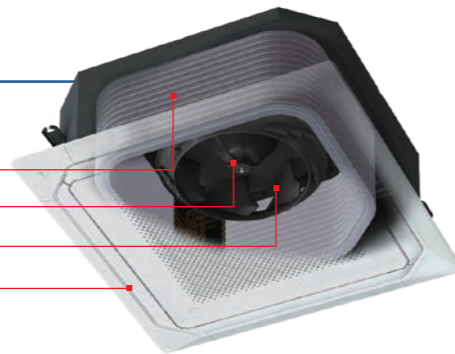

Uniform temperature air conditioning

Achieve a comfortable air conditioning spread to every corner of the room thanks to the circular flow and wide vertical airflow.

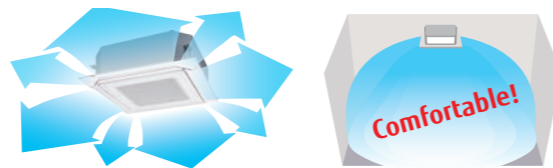

Individual louver control

Each louver can be set individually by the Touch panel wired remote controller so the user can enjoy the comfort of different directional airflows according to the room layout.

* UTY-RNRGZ5 Wired remote controller with touch panel and UTY-DCGGZ3 Central remote controller only



Comfortable air conditioning by preventing direct blowing of cold air and by providing swinging air flow simultaneously.

Provides efficient air conditioning based on the room layout

The Human sensor contributes to further energy savings.

Energy saving operation starts automatically by detecting the motion of a person. Two modes of save operation mode and stop mode can be selected.

* UTY-RNRGZ5 Wired remote controller with touch panel and UTY-DCGGZ3 Central remote controller only



Human sensor (Optional)

- 2 modes are available to choose from:
- Auto economy mode** The air conditioner switches to operate on reduced power when it detects that the room is unoccupied.
 - Auto-off mode** The air conditioner stops operating when it detects that the room is unoccupied.

Model: AUXM018GLEH / AUXM024GLEH / AUXM030GLEH



Specifications

Model name			AUXM018GLEH	AUXM024GLEH	AUXM030GLEH
Power source			Single phase, ~230 V, 50 Hz		
Capacity	Cooling	kW	5.6	7.1	9.0
	Heating		6.3	8.0	10.0
Input power	W		20	25	49
Airflow rate	High	m³/h	1,050	1,120	1,470
	Med-High		930	1,050	1,160
	Med		900	930	1,070
	Med-Low		870	900	930
	Low		810	870	900
	Quiet		780	780	780
Sound pressure level	High	dB(A)	33	35	40
	Med-High		32	33	36
	Med		31	32	34
	Med-Low		30	31	32
	Low		29	30	31
	Quiet		28	28	28
Dimensions (H × W × D)	mm		246 × 840 × 840		
Weight	kg		24.0	24.5	24.5
Connection pipe diameter	Liquid (Flare)	mm	6.35	9.52	9.52
	Gas (Flare)		12.70	15.88	15.88
Drain Hose Diameter (I.D./O.D.)			25/32		
Cassette Grille	Model name	UTG-UKGC-W/UTG-UKGA-B			
	Dimensions (H × W × D)	mm			
	Weight	kg			
			53 × 950 × 950		
			6.0		

Note: Specifications are subject to the following conditions:
 Cooling: Indoor temperature of 27°CDB/19°CWB, and outdoor temperature of 35°CDB/24°CWB.
 Heating: Indoor temperature of 20°CDB/15°CWB, and outdoor temperature of 7°CDB/6°CWB.
 Pipe length: 7.5 m; Height difference between outdoor unit and indoor unit: 0 m. Voltage: 230 [V].
 When AUX*018GLEH is connected to an outdoor unit other than one of the J-IVL Series, the pipe diameter should be Ø9.52/Ø15.88 mm (Liquid/Gas).
 When connecting AUXK036GLEH, AUXK045GLEH, and AUXK054GLEH to an outdoor unit other than the outdoor unit of the J-IVL Series, the gas pipe diameter should be Ø19.05 mm.

Optional parts

*For more details, please refer to the chapter "Optional parts".

Human sensor Kit: UTY-SHZXC	Air Outlet Shutter Plate: UTR-YDZK	IR Receiver Unit: UTY-LBHXD
Wide Panel: UTG-AKXA-W	Insulation kit for high humidity: UTZ-KXRA	WLAN adapter: UTY-TFSXZ1, UTY-TFSXJ3, FG-AC-WIF1Z1
Panel Spacer: UTG-BKXA-W	Cassette Grille: UTG-UKGC-W, UTG-UKGA-B	Silver Ion Filter: UTD-HFRA
Fresh air intake kit: UTZ-VXRA	External power supply unit: UTZ-GXXA, UTZ-GXXC*	Remote sensor kit: UTY-XSZXZ1

Dimensions

(Unit: mm)

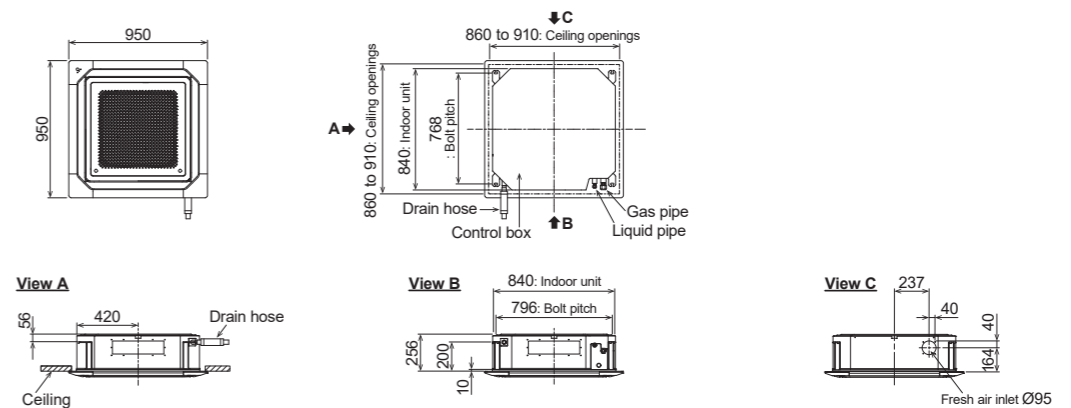

Cassette Large type

Circular Flow



Unique circular flow design

This Cassette type air conditioner is equipped with a high performance DC fan motor, a turbo fan, and a louver to propel powerful airflows in all directions.

- Ø7 mm high-density heat exchanger
- New DC fan motor
- High-efficiency turbo fan
- Seamless airflow louver

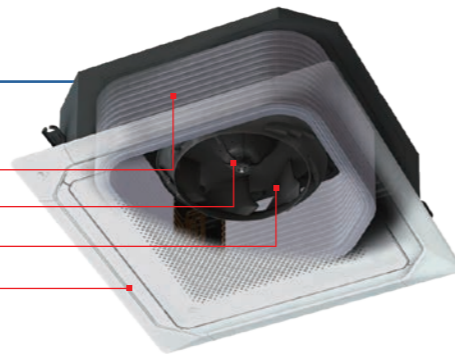

Uniform temperature air conditioning

Achieve a comfortable air conditioning spread to every corner of the room by circular flow and wide vertical airflow.

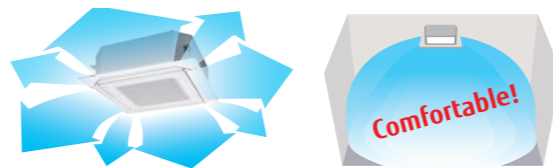

Individual louver control

Each louver can be set individually by the Touch panel wired remote controller so the user can enjoy the comfort of different directional airflows according to the room layout.

* UTY-RNRGZ5 Wired remote controller with touch panel and UTY-DCGGZ3 Central remote controller only



Comfortable air conditioning by preventing direct blowing of cold air and by providing swinging air flow simultaneously.

Provides efficient air conditioning based on the room layout

The Human sensor contributes to further energy savings.

Energy saving operation starts automatically by detecting the motion of a person. Two modes of save operation mode and stop mode can be selected.

* UTY-RNRGZ5 Wired remote controller with touch panel and UTY-DCGGZ3 Central remote controller only



Human sensor (Optional)

- 2 modes are available to choose from:
- Auto economy mode** The air conditioner switches to operate on reduced power when it detects that the room is unoccupied.
 - Auto-off mode** The air conditioner stops operating when it detects that the room is unoccupied.

Model: AUXK018GLEH / AUXK024GLEH / AUXK030GLEH
 AUXK034GLEH / AUXK036GLEH / AUXK045GLEH
 AUXK054GLEH



Specifications

Model name	AUXK018GLEH	AUXK024GLEH	AUXK030GLEH	AUXK034GLEH	AUXK036GLEH	AUXK045GLEH	AUXK054GLEH		
Power source	Single phase, ~230 V, 50 Hz								
Capacity	Cooling	5.6	7.1	9.0	10.0	11.2	12.5		
	Heating	6.3	8.0	10.0	11.2	12.5	14.0		
Input power	kW		4.0	4.0	4.7	4.7	6.1	8.9	11.6
Airflow rate	m ³ /h	High	1,420	1,420	1,440	1,440	1,620	1,820	2,040
		Med-High	1,360	1,360	1,400	1,400	1,500	1,590	1,800
		Med	1,300	1,300	1,340	1,340	1,400	1,500	1,590
		Med-Low	1,270	1,270	1,300	1,300	1,340	1,400	1,440
		Low	1,200	1,200	1,280	1,280	1,280	1,300	1,300
		Quiet	1,150	1,150	1,150	1,150	1,150	1,150	1,150
Sound pressure level	dB(A)	High	38	38	39	39	41	44	47
		Med-High	37	37	38	38	40	42	45
		Med	36	36	37	37	38	40	42
		Med-Low	35	35	36	36	37	38	39
		Low	34	34	35	35	36	36	36
		Quiet	33	33	33	33	33	33	33
Dimensions (H × W × D)	mm		288 × 840 × 840						
Weight	kg		26.5	26.5	29.5	29.5	29.5	29.5	
Connection pipe diameter	Liquid (Flare)	mm		6.35	9.52	9.52	9.52	9.52	
	Gas (Flare)	mm		12.70	15.88	15.88	15.88	15.88	
Drain Hose Diameter (I.D./O.D.)			25/32						
Cassette Grille	Model name	UTG-UKGC-W/UTG-UKGA-B							
	Dimensions (H × W × D)	mm		53 × 950 × 950					
	Weight	kg		6.0					

Note: Specifications are subject to the following conditions:
 Cooling: Indoor temperature of 27°CDB/19°CWB, and outdoor temperature of 35°CDB/24°CWB.
 Heating: Indoor temperature of 20°CDB/15°CWB, and outdoor temperature of 7°CDB/6°CWB.
 Pipe length: 7.5 m; Height difference between outdoor unit and indoor unit: 0 m. Voltage: 230 [V].
 When AUX*018GLEH is connected to an outdoor unit other than one of the J-IVL Series, the pipe diameter should be Ø9.52/Ø15.88 mm (Liquid/Gas).
 When connecting AUXK036GLEH, AUXK045GLEH, and AUXK054GLEH to an outdoor unit other than the outdoor unit of the J-IVL Series, the gas pipe diameter should be Ø19.05 mm.

Optional parts

*For more details, please refer to the chapter "Optional parts".

Human sensor Kit: UTY-SHZXC	Air Outlet Shutter Plate: UTR-YDZK	IR Receiver Unit: UTY-LBHXD
Wide Panel: UTG-AKXA-W	Insulation kit for high humidity: UTZ-KXRA	WLAN adapter: UTY-TFSXZ1, UTY-TFSXJ3, FG-AC-WIF1Z1
Panel Spacer: UTG-BKXA-W	Cassette Grille: UTG-UKGC-W, UTG-UKGA-B	Silver Ion Filter: UTD-HFRA
Fresh air intake kit: UTZ-VXRA	External power supply unit: UTZ-GXXA, UTZ-GXXC*	Remote sensor kit: UTY-XSZXZ1

Dimensions

(Unit: mm)

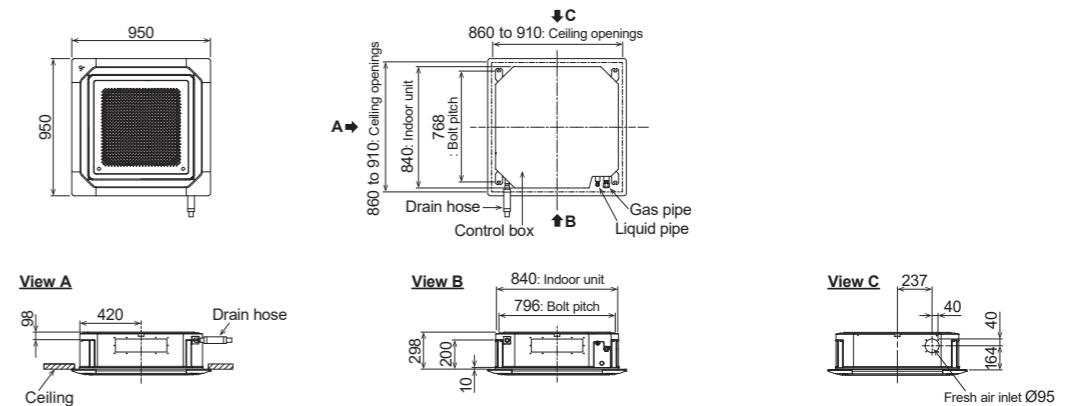

Cassette

One-way Flow type



Compact chassis size

The compact size allows easy installation in a variety of commercial facilities and environments.

- The height of the chassis is less than 200 mm for all models.
- All 4 to 12 kBTu models are less than 1,000 mm wide.
- The depth of the chassis is 570 mm, which fits nicely into a grid type ceiling.



Dimensions (Panel size) (Unit: mm)

	4	7	9	12	14	18	24
H		198 (43)				198 (43)	
W		785 (950)				1,190 (1,360)	
D		570 (620)				570 (620)	

Wide airflow range

A large flap with a wide range of movements, equipped with louvers arranged triangularly, sends air into every corner of the room.

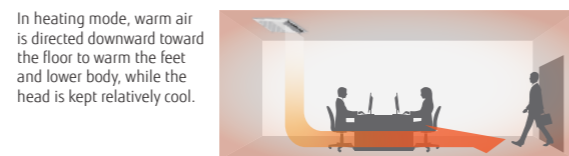
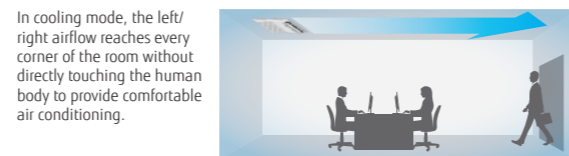

Note: This is a conceptual drawing. The performance of an air conditioner may vary depending on where it is installed, the size of the room, and its distance from the wall.

Quiet mode

The low operating noise makes the model ideal for use in hotel rooms.



Model: AUXV004GLEH / AUXV007GLEH / AUXV009GLEH
 AUXV012GLEH / AUXV014GLEH / AUXV018GLEH
 AUXV024GLEH



AUXV004/007/009/012GLEH



AUXV014/018/024GLEH

Specifications

Model name		AUXV004GLEH	AUXV007GLEH	AUXV009GLEH	AUXV012GLEH	AUXV014GLEH	AUXV018GLEH	AUXV024GLEH	
Power source		Single phase, ~230 V, 50 Hz							
Capacity	Cooling	1.1	2.2	2.8	3.6	4.5	5.6	7.1	
	Heating	1.3	2.8	3.2	4.0	5.0	6.3	8.0	
Input power		W	30/30	42/42	42/42	60/60	38/38	56/56	99/99
Airflow rate*	High	m ³ /h	460	550	550	670	720	890	1,150
	Med-High	440	440	440	520	660	840	1,020	
	Med	420	420	420	480	630	770	940	
	Med-Low	400	400	400	450	600	710	790	
	Low	380	380	380	410	580	660	700	
	Quiet	360	360	360	360	550	580	610	
Sound pressure level*	High	dB(A)	38	42	42	45	37	44	49
	Med-High	37	37	37	41	36	43	47	
	Med	36	36	36	39	35	40	45	
	Med-Low	35	35	35	38	34	38	42	
	Low	33	33	33	36	33	36	39	
	Quiet	32	32	32	32	32	34	36	
Net Dimensions (H × W × D)		mm	198 × 785 × 570	198 × 785 × 570	198 × 785 × 570	198 × 785 × 570	198 × 1,190 × 570	198 × 1,190 × 570	198 × 1,190 × 570
Weight		kg	18	19	19	19	26	26	27
Connection pipe diameter	Liquid (Flare)	mm	6.35	6.35	6.35	6.35	6.35	6.35	9.52
	Gas (Flare)	mm	9.52	9.52	9.52	12.70	12.70	12.70	15.88
Drain Hose Diameter (I.D./O.D.)						25/32			
Cassette Grille	Model name		UTG-UNGA-W			UTG-UNGB-W			
	Net Dimensions (H × W × D)	mm	43 × 950 × 620			43 × 1,360 × 620			
	Weight	kg	6.5			8.5			

Note: Specifications are subject to the following conditions:
 Cooling: Indoor temperature of 27°CDB/19°CWB, and outdoor temperature of 35°CDB/24°CWB.
 Heating: Indoor temperature of 20°CDB/15°CWB, and outdoor temperature of 7°CDB/6°CWB.
 Pipe length: 7.5 m; Height difference between outdoor unit and indoor unit: 0 m. Voltage: 230 [V]

Optional parts

*For more details, please refer to the chapter "Optional parts."

- WLAN adapter: UTY-TFSXZ1, UTY-TFSXJ3, FG-AC-WIF1Z1
 IR Receiver Unit: UTY-TRHX
 Cassette Grille: UTG-UNGA-W (004-012),
 UTG-UNGB-W (014-024)
 External power supply unit: UTZ-GXXA, UTZ-GXXC*
 Remote sensor kit: UTY-XSZXZ1

Flexible Installation

The L-shaped pipe kit allows for more flexible installation.
 Equipped with a built-in drain pump as standard, which enables a maximum pipe height difference of 700 m from the ceiling.

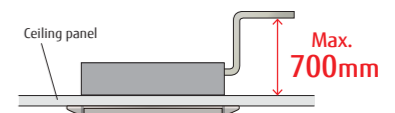

Dimensions

(Unit: mm)

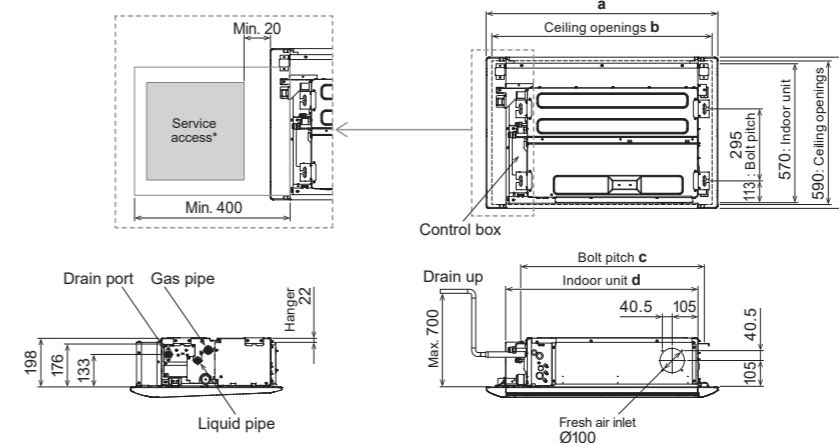

	AUXV 004 / 007 / 009 / 012 GLEH	AUXV 014 / 018 / 024 GLEH
a	950	1,360
b	920	1,330
c	752	1,152
d	785	1,190

*The design of the service access depends on the installation method. Refer to the installation manual for more information.

3D Flow Cassette



3 individually controlled air outlet ports

The Comfortable airflow setting enables the left and right air outlet ports as well as the wide center port to work together to provide a comfortable room environment.

Temperature distribution during cooling and heating (when set to Comfortable airflow)



Testing conditions: Model AUXS024GLEH running cooling operation with the air volume set to "Hi" to maintain the room temperature at 18°C with the outdoor temperature at 35°C, tested in our 40m² environmental test room

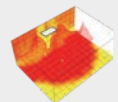

Testing conditions: Model AUXS024GLEH running heating operation with the air volume set to "Hi" to maintain the room temperature at 30°C with the outdoor temperature at 7°C, tested in our 40m² environmental test room

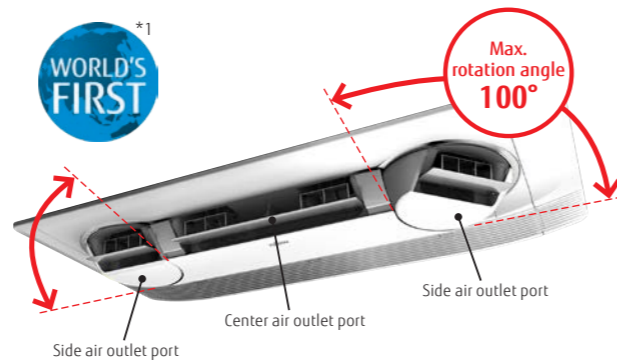

*1: Announced 2018. In the category of room air conditioners for the home (source: Fujitsu General Limited).

Individual airflow setting

The individual airflow setting function optimizes the airflow direction to match the room layout.

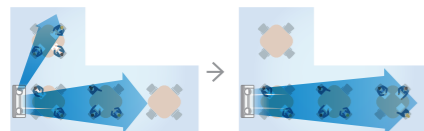

Adjusts airflows from the side air outlet ports to match the layout and usage of the room to minimize the amount of wasted airflow.



The airflow is optimally controlled to provide improved comfort in a narrow room.

Individual control of air outlet ports

Individual airflow can be set using a Wired remote controller with touch panel and Central remote controller*. The airflow from each air outlet port can be set individually.



Wired remote controller with Touch Panel
UTY-RNRGZ5



Central remote controller
UTY-DCGGZ3

* Feature available only on UTY-RNRGZ5 Wired remote controller with touch panel and UTY-DCGGZ3 Central remote controller

High energy saving

The structural design to take in a larger volume of air and blow air out more smoothly reduces air blowing loss and achieves class-leading energy-saving performance.

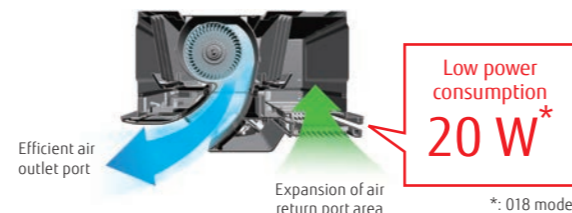

*: 018 model

Model: AUXS018GLEH / AUXS024GLEH



Specifications

Model name		AUXS018GLEH	AUXS024GLEH
Power source		Single phase, ~230 V, 50 Hz	
Capacity	Cooling	5.60	7.10
	Heating	6.30	8.00
Input power		20/28	34/43
Airflow rate*	High	750/870	950/1,040
	Med-High	710/830	890/990
	Med	690/780	860/930
	Med-Low	660/740	810/880
	Low	630/700	770/840
	Quiet	540/540	540/540
Sound pressure level*	High	38/41	43/46
	Med-High	36/40	42/45
	Med	35/39	41/43
	Med-Low	35/37	40/42
	Low	33/36	38/40
	Quiet	29/29	29/29
Net Dimensions (H × W × D)		mm 200 × 1,240 × 500	200 × 1,240 × 500
Weight		kg 25	25
Connection pipe diameter	Liquid (Flare)	6.35	9.52
	Gas (Flare)	12.70	15.88
Drain Hose Diameter (I.D./O.D.)		25/32	
Cassette Grille	Model name	UTG-USGA-W	
	Net Dimensions (H × W × D)	mm 85 × 1,350 × 580	
	Weight	kg 11.5	

Note: Specifications are subject to the following conditions:
Cooling: Indoor temperature of 27°CDB/19°CWB, and outdoor temperature of 35°CDB/24°CWB.
Heating: Indoor temperature of 20°CDB/15°CWB, and outdoor temperature of 7°CDB/6°CWB.
Pipe length: 7.5 m; Height difference between outdoor unit and indoor unit: 0 m. Voltage: 230 [V]
*: Applicable to cooling and heating operation

Optional parts

- WLAN adapter: UTY-TFSXZ1, UTY-TFSXJ3, FG-AC-WIF1Z1
- IR Receiver Unit: UTY-TRHX
- Cassette Grille: UTG-USGA-W
- External power supply unit: UTZ-GXXA, UTZ-GXXC*
- Remote sensor kit: UTY-XSZXZ1

Dimensions

(Unit: mm)

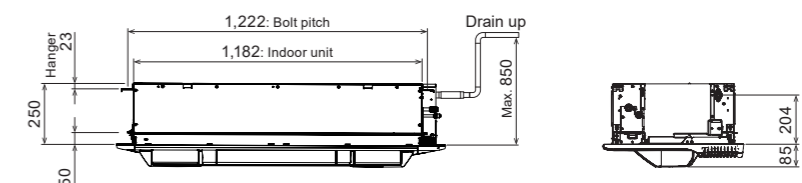
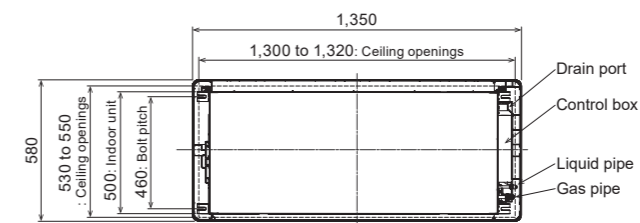

Low Static Pressure Duct Mini Duct (With drain pump)



Space saving design

- Fits into a space 198 mm high and 450 mm deep
- 30% smaller than previous-generation models
- Weighs 16 kg, 10% lighter

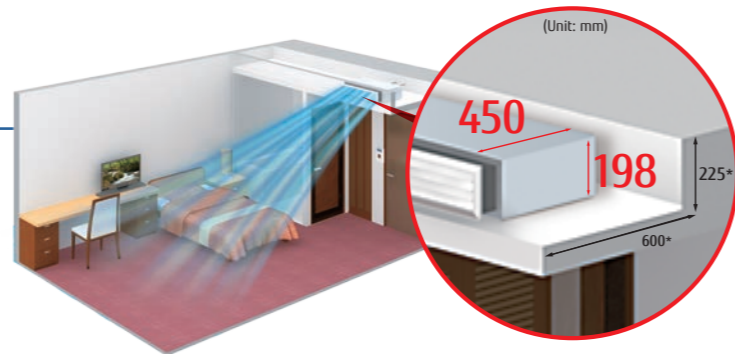

*: Minimum clearance requirement

Optimum airflow path and low noise operation

The stabilized airflow reduces the noise level significantly.

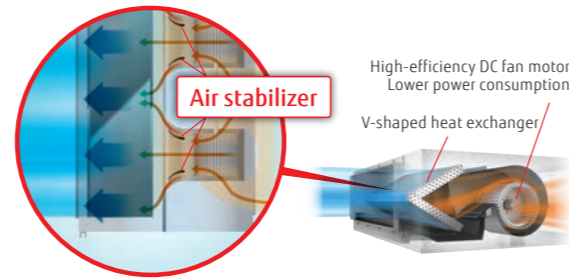

6-speed control*

Multistep airflow adjustment allows installation in a quiet location.

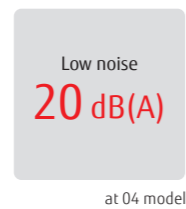

at 04 model

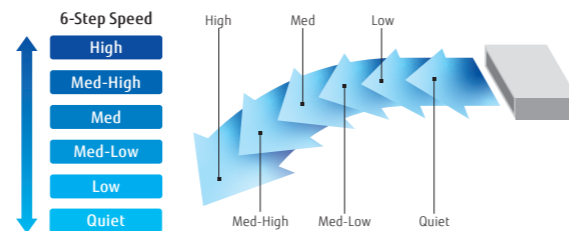

* Remote controller is compatible with the following:
UTY-RNRGZ5/UTY-RLRG/UTY-PSRG/UTY-RHRG/UTY-DCGGZ2/UTY-ALGXZ1/UTY-APGXZ1

Easy to design and maintain for drain

Indoor unit design for easy maintenance. Parts can be replaced from the side of the unit where maintenance is easier.

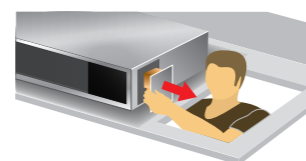

A drain pump is built into the unit as standard. Parts can be accessed and replaced through the side of the unit for easy maintenance.

Model: ARXK004GLGH / ARXK007GLGH / ARXK009GLGH
ARXK012GLGH / ARXK014GLGH / ARXK018GLGH
ARXK024GLGH



Specifications

Model name	ARXK004GLGH	ARXK007GLGH	ARXK009GLGH	ARXK012GLGH	ARXK014GLGH	ARXK018GLGH	ARXK024GLGH
Power source	Single phase, ~230 V, 50 Hz						
Capacity	Cooling	1.1	2.2	2.8	3.6	4.5	7.1
	Heating	1.3	2.8	3.2	4.0	5.0	8.0
Input power	W	26	28	28	35	66	80
Airflow rate	High	460	460	460	550	760	1,160
	Med-High	440	440	440	520	660	1,060
	Med	420	420	420	480	560	960
	Med-Low	400	400	400	450	490	860
	Low	370	370	370	410	410	750
	Quiet	340	340	340	340	340	610
Static pressure range	Pa	0 to 30	0 to 30	0 to 30	0 to 30	0 to 50	0 to 50
Standard static pressure		10	10	10	10	15	15
Sound pressure level	High	25	26	26	29	34	32
	Med-High	24	25	25	27	31	30
	Med	23	24	24	26	28	28
	Med-Low	22	23	23	25	26	27
	Low	21	22	22	24	24	25
	Quiet	20	21	21	22	22	22
Net Dimensions (H × W × D)	mm	198 × 700 × 450	198 × 700 × 450	198 × 700 × 450	198 × 700 × 450	198 × 700 × 450	198 × 1,100 × 450
Weight	kg	14.5	15.5	15.5	16	16	22.5
Connection pipe diameter	Liquid (Flare)	6.35	6.35	6.35	6.35	6.35	9.52
	Gas (Flare)	9.52	9.52	9.52	12.70	12.70	15.88
Drain Hose Diameter (I.D./O.D.)		25/32					

Note: Specifications are subject to the following conditions:
Cooling: Indoor temperature of 27°CDB/19°CWB, and outdoor temperature of 35°CDB/24°CWB.
Heating: Indoor temperature of 20°CDB/15°CWB, and outdoor temperature of 7°CDB/6°CWB.
Pipe length: 7.5 m; Height difference between outdoor unit and indoor unit: 0 m. Voltage: 230 [V].

Optional parts

*For more details, please refer to the chapter "Optional parts".

- | | | | |
|---------------------|--------------------|-----------------------------|----------------------------------|
| Remote sensor unit: | UTY-XSZXZ1 | External power supply unit: | UTZ-GXXA, UTZ-GXXC* |
| IR receiver unit: | UTY-TRHX | Auto Louver Grille Kit: | UTD-GXTA-W (004-014) |
| Silver Ion Filter: | UTD-HFTA (004-014) | | UTD-GXTB-W (018) |
| | UTD-HFTB (018) | | UTD-GXTC-W (024) |
| | UTD-HFTC (024) | WLAN adapter: | FG-AC-WIF1Z1 |
| | | | UTY-TFSXJ3, UTY-TFSXZ1 (007-024) |

Auto Louver Grille Kit (Optional)

The slim design of the unit provides comfortable cooling and heating air conditioning over a wide area. The optional automatic louver grille, which fits nicely into any interior decor, provides comfortable air conditioning (Optional)



Dimensions

(Unit: mm)

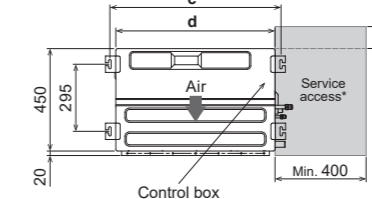
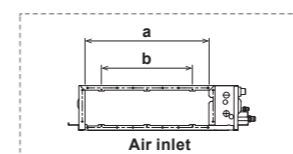

	ARXK 004-014GLGH	ARXK018GLGH	ARXK024GLGH
a	575	775	975
b	P200×2=400	P200×3=600	P200×4=800
c	752	952	1,152
d	700	900	1,100
e	650	850	1,050
f	P100×6=600	P100×8=800	P100×10=1,000

*The design of the service access depends on the installation method. Refer to the installation manual for more information.

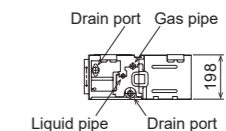
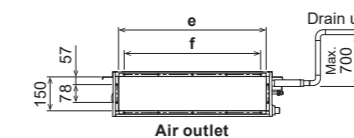
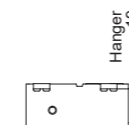

Low Static Pressure Duct Slim Duct/Slim Concealed Floor



Slim design

Slim design allows for installation in a tight ceiling space.

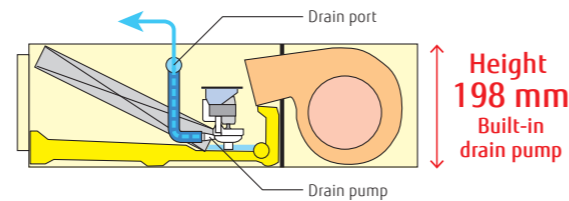

Air intake

Air intake direction can be selected to match the installation site.

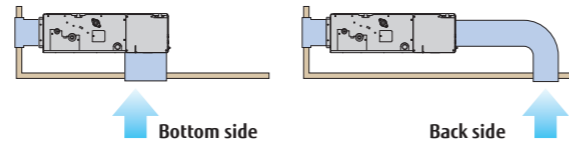

Flexible installation

Ceiling concealed

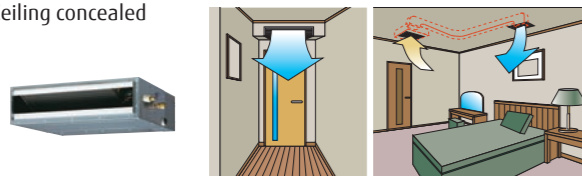

Floor concealed

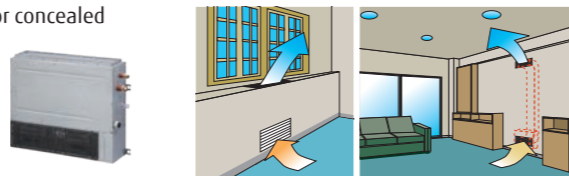

Wide range of static pressures

The use of a DC fan motor makes it possible to adjust the static pressure between 0 and 90 Pa. The static pressure range can be changed by a remote controller.



Static pressure range
0 to 90 Pa

*024 model static pressure range is 0 to 50 Pa.

Filter (Accessory)

ARXD04/007/009/012/014/018 ARXD024

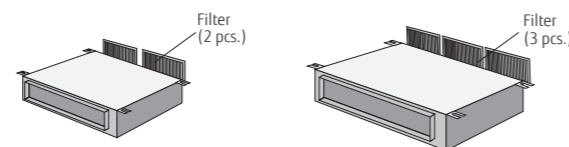

Model: ARXD04GALH / ARXD007GLEH / ARXD009GLEH
ARXD012GLEH / ARXD014GLEH / ARXD018GLEH
ARXD024GLEH

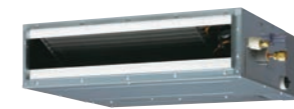

ARXD04GALH
ARXD007/009/012/014GLEH

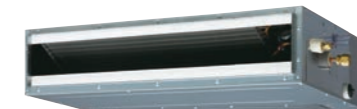

ARXD018GLEH



ARXD024GLEH

Slim Concealed Floor



Specifications

Model name	ARXD04GALH*	ARXD007GLEH	ARXD009GLEH	ARXD012GLEH	ARXD014GLEH	ARXD018GLEH	ARXD024GLEH
Power source	Single phase, ~230 V, 50 Hz						
Capacity	Cooling	1.1	2.2	2.8	3.6	4.5	7.1
	Heating	1.3	2.8	3.2	4.0	5.0	8.0
Input power	W	40	44	50	54	92	122
Airflow rate	High	510	550	600	600	800	1,330
	Med-High	-	480	510	530	680	1,140
	Med	400/470*1	440	460	490	600	730
	Med-Low	-	410	420	450	520	630
	Low	320/440*1	370	370	410	440	540
Quiet	-	320	320	340	340	470	610
Static pressure range	Pa	0 to 90	0 to 90	0 to 90	0 to 90	0 to 90	0 to 50
Standard static pressure	Pa	25	25	25	25	25	25
Sound pressure level	High	26	28	29	30	34	35
	Med-High	-	26	27	28	32	31
	Med	21/25*1	25	25	27	30	29
	Med-Low	-	24	24	26	28	27
	Low	20/22*1	22	22	24	25	24
Quiet	-	21	21	22	22	23	21
Net Dimensions (H × W × D)	mm	198 × 700 × 620	198 × 700 × 620	198 × 700 × 620	198 × 700 × 620	198 × 700 × 620	198 × 900 × 620
Weight	kg	17	17	17	18	18	26
Connection pipe diameter	Liquid (Flare)	6.35	6.35	6.35	6.35	6.35	9.52
	Gas (Flare)	12.70	9.52	9.52	12.70	12.70	15.88
Drain Hose Diameter (I.D./O.D.)				25/32			

Note: Specifications are subject to the following conditions:

Cooling: Indoor temperature of 27°CDB/19°CWB, and outdoor temperature of 35°CDB/24°CWB.

Heating: Indoor temperature of 20°CDB/15°CWB, and outdoor temperature of 7°CDB/6°CWB.

Pipe length: 7.5 m; Height difference between outdoor unit and indoor unit: 0 m. Voltage: 230 [V].

*1: This value is under cooling operation.

*: ARXD04GALH cannot be connected to J-IVS/J-IVJ-IVL/VR-IV Series.

Optional parts

*For more details, please refer to the chapter "Optional parts".

Remote sensor unit: UTY-XS2XZ1

IR receiver unit: UTB-YWC (04)

UTY-TRHX (007-024)

UTY-TFSXJ3 (007-024)

UTY-TFSXZ1 (007-024)

FG-RC-WIF122 (04)

FG-AC-WIF121 (007-024)

External power supply unit: UTZ-GXXA, UTZ-GXXC*

Auto Louver Grille Kit: UTD-GXTA-W (04, 007-014)

UTD-GXTB-W (018)

UTD-GXTC-W (024)

UTD-HFTA (04, 007-014)

UTD-HFTB (018)

UTD-HFTC (024)

Dimensions

(Unit: mm)

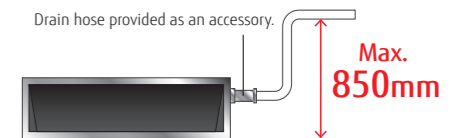
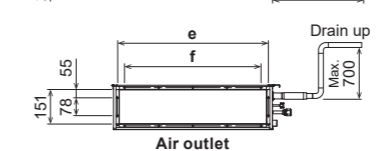
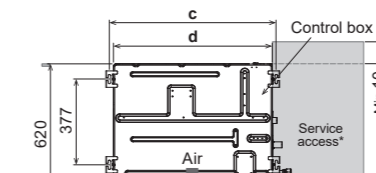
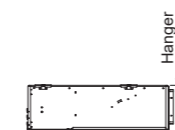
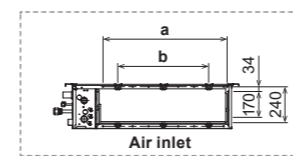

	ARXD04GALH ARXD 007-014GLEH	ARXD018GLEH	ARXD024GLEH
a	574	774	974
b	P200×2=400	P200×3=600	P200×4=800
c	734	934	1,134
d	700	900	1,100
e	650	850	1,050
f	P100×6=600	P100×8=800	P100×10=1,000

*The design of the service access depends on the installation method. Refer to the installation manual for more information.

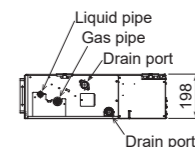

Low Static Pressure Duct

High Efficiency



Slim & Compact design

The slim and compact design of the indoor unit, with the control box mounted on the side, allows installation in narrow spaces.

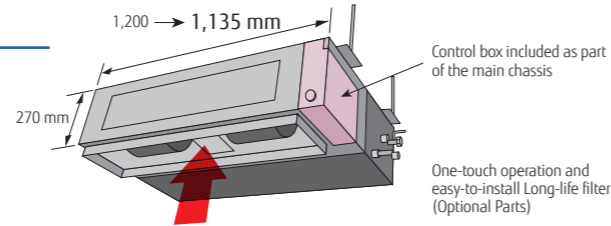

Easy maintenance

Structural improvement has been developed by making the bottom panel in two pieces, front and rear. The internal fan casing is also manufactured in two pieces—upper and lower. The motor and fan can be easily accessed and maintained by removing the rear panel and the lower casing with the main chassis remaining in place.

See below for rear-suction type

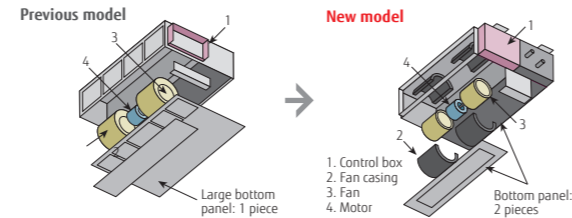

Installation styles

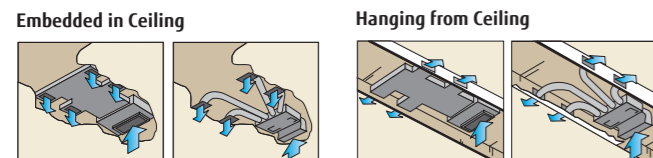

A drain pipe can be installed on either the left or right side of the unit

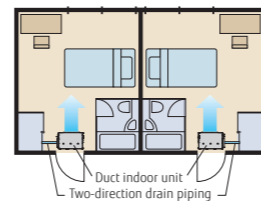

High-efficiency DC fan motor achieves low-energy consumption.

Improved motor efficiency from previous model.

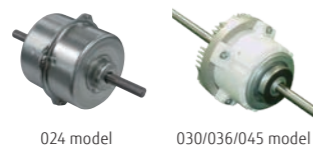

Wide range of static pressures

Static pressures can be changed in the range of 0 to 150 Pa.

Static pressure range
0 to 80 Pa

Model: ARXP018GLFH / ARXP030GLFH * Production by order

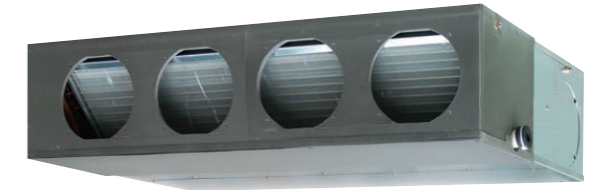

Specifications

Model name		ARXP018GLFH	ARXP030GLFH
Power source		Single-phase, ~220V, 50Hz	
Capacity	Cooling	5.6	9.0
	Heating	6.3	10.0
Input power		128	228
Airflow rate	High	1,540 / 1,440	1,940 / 1,660
	Med-High	1,460 / 1,380	1,810 / 1,580
	Med	1,380 / 1,320	1,680 / 1,510
	Med-Low	1,300 / 1,260	1,550 / 1,440
	Low	1,220 / 1,200	1,420 / 1,370
Quiet		1,150 / 1,150	1,300 / 1,300
Static pressure range		Pa	
Standard static pressure		40	50
Sound pressure level	High	35 / 34	39 / 36
	Med-High	34 / 32	38 / 35
	Med	32 / 31	36 / 34
	Med-Low	31 / 30	34 / 33
	Low	29 / 29	32 / 31
Quiet		28 / 28	30 / 30
Net Dimensions (H × W × D)		mm 270 × 1,135 × 700	270 × 1,135 × 700
Weight		kg 40	40
Connection pipe diameter	Liquid (Flare)	6.35	9.52
	Gas (Flare)	12.70	15.88
Drain Hose Diameter (I.D./O.D.)		25/32	

Note: Specifications are subject to the following conditions:
Cooling: Indoor temperature of 27°CDB/19°CWB, and outdoor temperature of 35°CDB/24°CWB.
Heating: Indoor temperature of 20°CDB/15°CWB, and outdoor temperature of 7°CDB/6°CWB.
Pipe length: 7.5 m; Height difference between outdoor unit and indoor unit: 0 m. Voltage: 230 [V].

Optional parts

*For more details, please refer to the chapter "Optional parts".

- Long-life filter: UTD-LF25NA
- Flange (square): UTD-SF045T
- Flange (round): UTD-RF204
- External power supply unit: UTZ-GXXA, UTZ-GXXC*
- Remote sensor unit: UTY-XS2XZ1
- IR receiver unit: UTY-TRHX
- Drain pump unit: UTZ-PX1NBA
- WLAN adapter: UTY-TFSXZ1, UTY-TFSXJ3, FG-AC-WIF1Z1
- Silver Ion Filter: UTD-HFND

Dimensions

(Unit: mm)

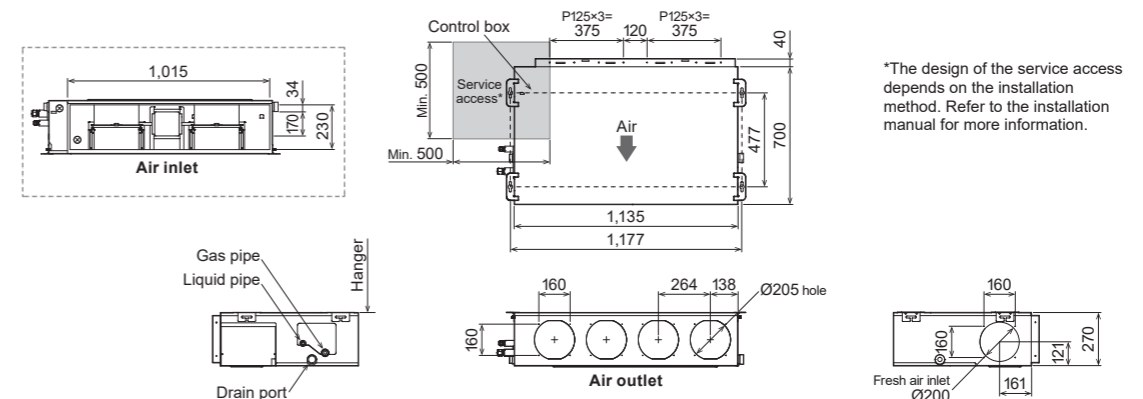

*The design of the service access depends on the installation method. Refer to the installation manual for more information.

Medium Static Pressure Duct Normal



Slim & Compact design

The slim and compact design of the indoor unit, with the control box mounted on the side, allows installation in narrow spaces.

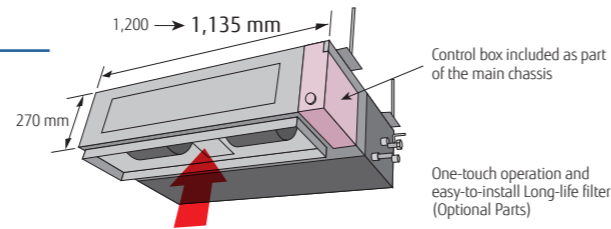

Easy maintenance

Structural improvement has been developed by making the bottom panel in two pieces, front and rear. The internal fan casing is also manufactured in two pieces—upper and lower. The motor and fan can be easily accessed and maintained by removing the rear panel and the lower casing with the main chassis remaining in place.

See below for rear-suction type

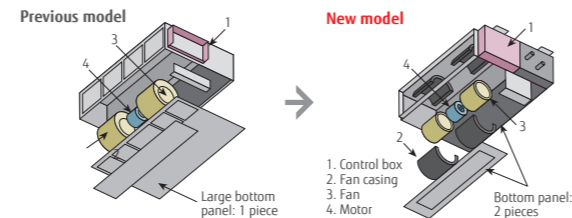

Installation styles

Embedded in Ceiling

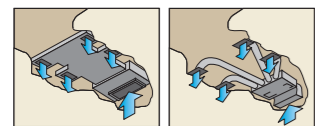

Hanging from Ceiling

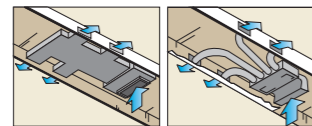

A drain pipe can be installed on either the left or right side of the unit

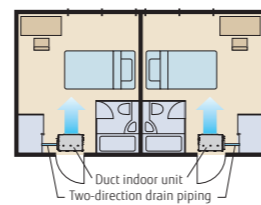

High-efficiency DC fan motor achieves low-energy consumption.

Improved motor efficiency from previous model.

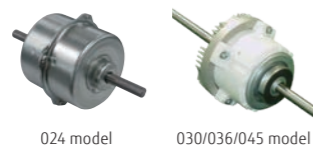

Wide range of static pressures

Static pressures can be changed in the range of 0 to 150 Pa.

Static pressure range
0 to 150 Pa

Model: ARXA024GLEH / ARXA030GLEH / ARXA036GLEH / ARXA045GLEH

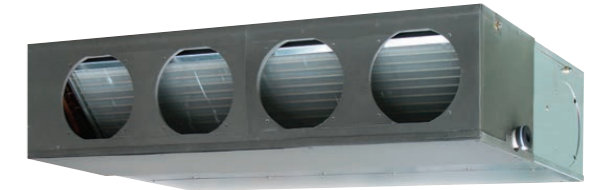

Specifications

Model name	ARXA024GLEH	ARXA030GLEH	ARXA036GLEH	ARXA045GLEH	
Power source	Single phase, ~230 V, 50 Hz				
Capacity	Cooling	7.1	9.0	11.2	12.5
	Heating	8.0	10.0	12.5	14.0
Input power	W	94	108	194	240
Airflow rate	High	1,280	1,410	1,840	1,970
	Med-High	1,180	1,350	1,750	1,910
	Med	1,090	1,280	1,660	1,860
	Med-Low	1,000	1,240	1,600	1,780
	Low	920	1,190	1,530	1,710
Quiet	840	1,150	1,470	1,640	
Static pressure range	Pa	0 to 150	0 to 150	0 to 150	0 to 150
Standard static pressure		40	50	50	60
Sound pressure level	High	31	34	37	41
	Med-High	29	33	36	40
	Med	27	32	35	38
	Med-Low	26	31	35	38
	Low	24	30	34	37
Quiet	23	29	33	36	
Net Dimensions (H × W × D)	mm	270 × 1,135 × 700	270 × 1,135 × 700	270 × 1,135 × 700	270 × 1,135 × 700
Weight	kg	36	40	40	40
Connection pipe diameter	Liquid (Flare)	9.52	9.52	9.52	9.52
	Gas (Flare)	15.88	15.88	15.88	15.88
Drain Hose Diameter (I.D./O.D.)					25/32

Note: Specifications are subject to the following conditions:
Cooling: Indoor temperature of 27°CDB/19°CWB, and outdoor temperature of 35°CDB/24°CWB.
Heating: Indoor temperature of 20°CDB/15°CWB, and outdoor temperature of 7°CDB/6°CWB.
Pipe length: 7.5 m; Height difference between outdoor unit and indoor unit: 0 m. Voltage: 230 [V].

Optional parts

*For more details, please refer to the chapter "Optional parts".

- Long-life filter: UTD-LF25NA
- Flange (square): UTD-SF045T
- Flange (round): UTD-RF204
- External power supply unit: UTZ-GXXA, UTZ-GXXC*
- Remote sensor unit: UTY-XS2XZ1
- IR receiver unit: UTY-TRHX
- Drain pump unit: UTZ-PX1NBA
- WLAN adapter: UTY-TFSXZ1, UTY-TFSXJ3, FG-AC-WIF1Z1
- Silver Ion Filter: UTD-HFND

Dimensions

(Unit: mm)

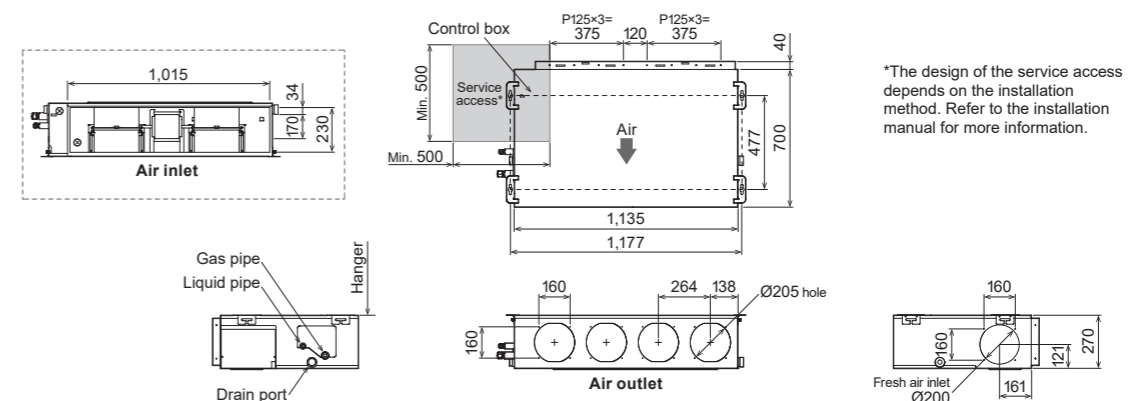

*The design of the service access depends on the installation method. Refer to the installation manual for more information.

High Static Pressure Duct Normal



Model: ARXC036GTEH / ARXC045GTEH / ARXC060GTEH
ARXC072GTEH / ARXC090GTEH / ARXC096GTEH



ARXC036/045/060GTEH



ARXC072/090GTEH



ARXC096GTEH

Static pressure mode selection

The use of a DC fan motor makes it possible to adjust the static pressure between 0 to 200 Pa (ARXC036) / 250Pa (ARXC045/060) / 300 Pa (ARXC072/090/096)

MAX. 200 Pa (036 type)



(ARXC036/045/060 type)

MAX. 250 Pa (045/060 type)



(ARXC072/090 type)

MAX. 300 Pa



(ARXC096 type)

MAX. 300 Pa

Easy installation (Compact & Lightweight)

The indoor unit is designed to be compact and light by reducing the basic chassis size and the overall material weight.



(ARXC036/045/060 type)



(ARXC072/090 type)

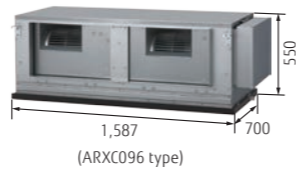

(ARXC096 type)

(Unit: mm)

Low noise

Models: ARXC036/ARXC045/ARXC060

The corners of the front panel and fan casing of the indoor unit are shaved to reduce air turbulence. The use of a plastic case and fan reduces the noise level generated by the unit.

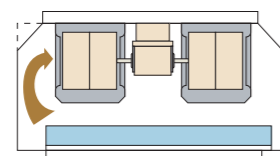

ARXC036GTEH: Plastic fan [42 dB(A)]

* Model: Material (Actual noise measurement value measured at 100 Pa)

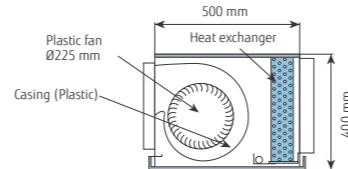

High-efficiency DC fan motor achieves low energy consumption.

Improved motor efficiency compared to the previous model



(ARXC036/045/060 type)



(ARXC072/090/096 type)

Specifications

Model name	ARXC036GTEH	ARXC045GTEH	ARXC060GTEH*	ARXC072GTEH*	ARXC090GTEH*	ARXC096GTEH*
Power source	Single phase, ~230 V, 50 Hz					
Capacity	Cooling	11.2	12.5	18.0	22.4	28.0
	Heating	12.5	14.0	20.0	25.0	31.5
Input power	W	207	715	730	681	819
Airflow rate	High	1,990	3,500	3,500	3,900	4,300
	Med	1,680	3,000	3,000	3,300	4,000
	Low	1,330	2,460	2,460	3,000	3,500
Static pressure range	Pa	0 to 200	100 to 250	100 to 250	0 to 300	0 to 300
Standard static pressure	Pa	100	100	100	150	150
Sound pressure level	High	42	49	49	47	48
	Med	36	45	45	43	46
	Low	32	42	42	40	44
Net Dimensions (H x W x D)	mm	400 x 1,050 x 500	400 x 1,050 x 500	400 x 1,050 x 500	450 x 1,587 x 700	450 x 1,587 x 700
Weight	kg	40	46	46	84	84
Connection pipe diameter	Liquid	9.52 (Flare)	9.52 (Flare)	9.52 (Flare)	9.52 (Flare)	9.52 (Flare)
	Gas	15.88 (Flare)	15.88 (Flare)	15.88 (Flare)	19.05 (Flare)	19.05 (Flare)
Drain Hose Diameter (I.D./O.D.)						25/32

Note: Specifications are based on the following conditions:
Cooling: Indoor temperature of 27°CDB/19°CWB, and outdoor temperature of 35°CDB/24°CWB.
Heating: Indoor temperature of 20°CDB/15°CWB, and outdoor temperature of 7°CDB/6°CWB.
Pipe length: 7.5 m; Height difference between outdoor unit and indoor unit: 0 m. Voltage: 230 [V]
*: ARXC060/072/090/096G cannot be connected to J-IVJ-IVS Series.

Optional parts

*For more details, please refer to the chapter "Optional parts".

Long-life filter: UTD-LF60KA (036/045/060) WLAN adapter: UTY-TFSXZ1, UTY-TFSXJ3, FG-AC-WIF121
IR receiver unit: UTY-TRHX Silver Ion Filter: UTD-HFKB (036/045/060)
External power supply unit: UTZ-GXXA, UTZ-GXXC* Remote sensor unit: UTY-XSZXZ1

Dimensions

(Unit: mm)

Models: ARXC036/ARXC045/ARXC060

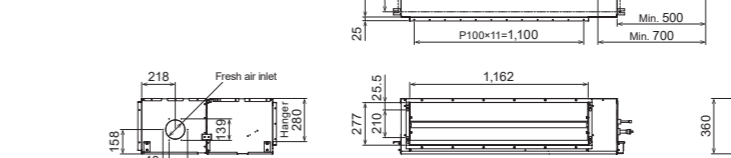
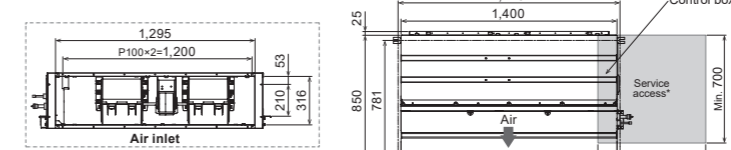

*The design of the service access depends on the installation method. Refer to the installation manual for more information.

Models: ARXC072/ARXC090/ARXC096

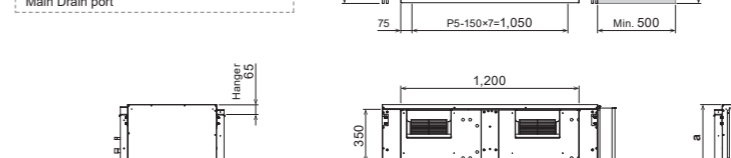
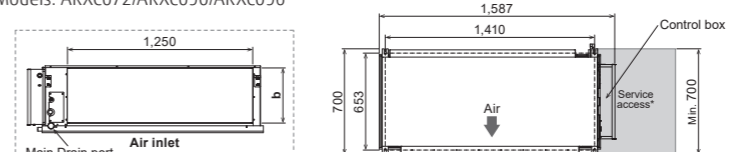

	ARXC072/090GTEH	ARXC096GTEH
a	450	550
b	370	470

*The design of the service access depends on the installation method. Refer to the installation manual for more information.

Compact floor



2-fan and wide airflow

A 2-fan individual vertical airflow cools or warms the entire room comfortably.

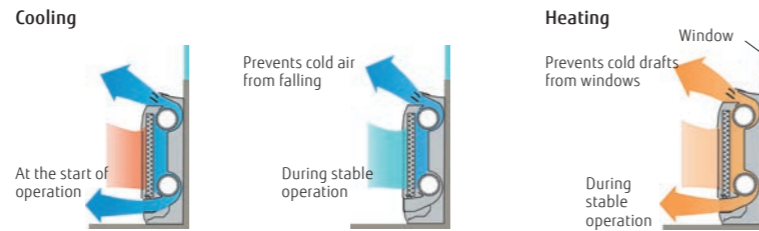

Flexible and easy installation

The compact and whole-surface suction design provides flexible installation options, including floor-standing, embedded, partially embedded, and wall-mounted installation to match the room layout.

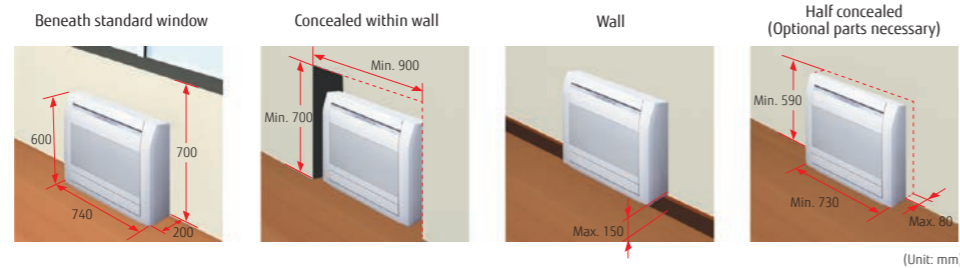

Quiet operation

6-fan speed control for quiet operation (via 2-wire controller)

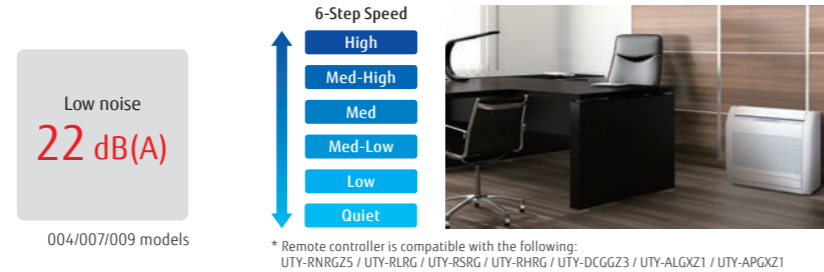

Flexible pipe connection enables draining and piping in 6 directions

The drain hose and pipe can be connected to the unit in the right, left, straight in depth, or downward direction.

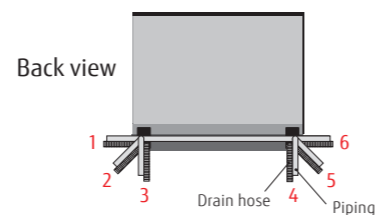

Model: AGHA004GCGH / AGHA007GCGH / AGHA009GCGH
 AGHA012GCGH / AGHA014GCGH
 [external EEV]
 AGHE004GCEH / AGHE007GCEH / AGHE009GCEH
 AGHE012GCEH / AGHE014GCEH



Specifications

Model name		AGHA004GCGH	AGHA007GCGH	AGHA009GCGH	AGHA012GCGH	AGHA014GCGH	AGHE004GCEH	AGHE007GCEH	AGHE009GCEH	AGHE012GCEH	AGHE014GCEH	
Power source		Single phase, ~230 V, 50 Hz						Single phase, ~230 V, 50 Hz				
Capacity	Cooling	1.1	2.2	2.8	3.6	4.0	1.1	2.2	2.8	3.6	4.0	
	Heating	1.3	2.8	3.2	4.0	4.5	1.3	2.8	3.2	4.0	4.5	
Input power		12/14	16	17	22	29	14	16	17	22	29	
Airflow rate	High	380/430	470	500	590	670	380/430	470	500	590	670	
	Med-High	350	420	450	520	590	350	420	450	520	590	
	Med	320	390	400	470	520	320	390	400	470	520	
	Med-Low	310	360	360	420	450	310	360	360	420	450	
	Low	280	330	330	390	390	280	330	330	390	390	
Sound pressure level	High	210	270	270	340	340	210	270	270	340	340	
	Med-High	35/36	37	38	42	46	35/36	37	38	42	46	
	Med	33	35	36	39	42	33	35	36	39	42	
	Med-Low	31	33	34	37	39	31	33	34	37	39	
	Low	30	31	31	35	36	30	31	31	35	36	
Quiet	28	29	29	33	33	28	29	29	33	33		
Quiet	22	22	22	30	30	22	22	22	30	30		
Net Dimensions (H × W × D)		600 × 740 × 200						600 × 740 × 200				
Weight		15.0	15.0	15.0	15.0	15.0	14.5	14.5	14.5	14.5	14.5	
Connection pipe diameter	Liquid (Flare)	6.35	6.35	6.35	6.35	6.35	6.35	6.35	6.35	6.35	6.35	
	Gas (Flare)	9.52	9.52	9.52	12.70	12.70	9.52	9.52	9.52	12.70	12.70	
Drain Hose Diameter (I.D./O.D.)		13.8/15.8 to 16.7						13.8/15.8 to 16.7				
EV kit (optional)								UTR-EV09XB		UTR-EV14XB		

Note: Specifications are subject to the following conditions:
 Cooling: Indoor temperature of 27°CDB/19°CWB, and outdoor temperature of 35°CDB/24°CWB.
 Heating: Indoor temperature of 20°CDB/15°CWB, and outdoor temperature of 7°CDB/6°CWB.
 Pipe length: 7.5 m; Height difference between outdoor unit and indoor unit: 0 m. Voltage: 230 [V]
 When connecting AGHA004/007/009GCGH, AGHE004/007/009GCEH to an outdoor unit other than an outdoor unit of the J-VL Series, the gas pipe diameter should be Ø12.70 mm.

Optional parts

- Partially concealing kit: UTR-STA
- External power supply unit: UTZ-GXXA, UTZ-GXXC*
- WLAN adapter: UTY-TFSXZ1, UTY-TFSXJ3, FG-AC-WIF1Z1
- Silver Ion Filter: UTR-FA03-5

Dimensions

(Unit: mm)

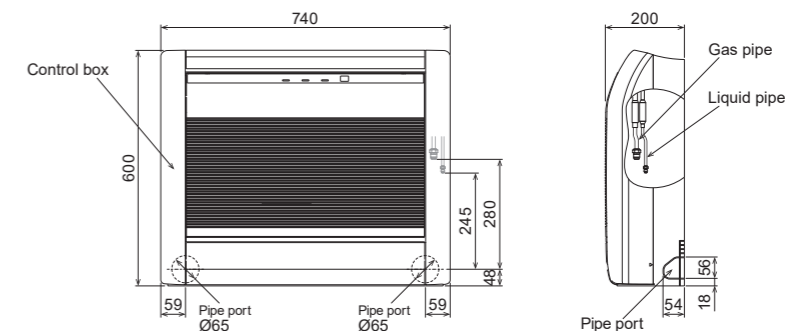

Floor/Ceiling



Flexible installation

Example of floor standing installation

Floor standing console with the back against the wall



Example of ceiling installation

Under ceiling



Double auto swing

The combination of horizontal and vertical swings enables 3-dimensional control of the airflow direction.

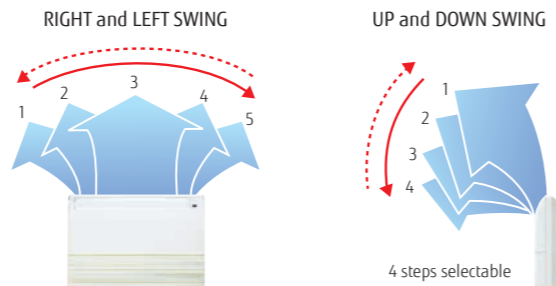

High-power DC fan motor

- High power
- Wide rotation range
- High-efficiency



Compact design

Symmetrical, slim and compact design.

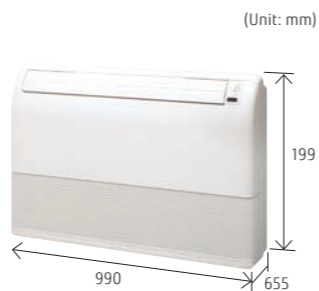

Model: ABHA012GTEH / ABHA014GTEH / ABHA018GTEH / ABHA024GTEH



Specifications

Model name		ABHA012GTEH	ABHA014GTEH	ABHA018GTEH	ABHA024GTEH
Power source		Single phase, ~230 V, 50 Hz			
Capacity	Cooling	3.6	4.5	5.6	7.1
	Heating	4.0	5.0	6.3	8.0
Input power		30	42	74	99
Airflow rate	High	660	780	1,000	1,000
	Med-High	620	740	910	930
	Med	580	690	830	870
	Med-Low	550	640	750	800
	Low	520	600	660	740
	Quiet	490	550	580	680
Sound pressure level	High	36	40	46	47
	Med-High	34	39	44	45
	Med	33	38	42	43
	Med-Low	31	36	40	41
	Low	29	35	37	39
	Quiet	28	34	35	37
Net Dimensions (H × W × D)		mm 199 × 990 × 655	mm 199 × 990 × 655	mm 199 × 990 × 655	mm 199 × 990 × 655
Weight		kg 25	kg 26	kg 26	kg 27
Connection pipe diameter	Liquid (Flare)	6.35	6.35	6.35	9.52
	Gas (Flare)	12.70	12.70	12.70	15.88
Drain Hose Diameter (I.D./O.D.)		25/32			

Note: Specifications are subject to the following conditions:
 Cooling: Indoor temperature of 27°CDB/19°CWB, and outdoor temperature of 35°CDB/24°CWB.
 Heating: Indoor temperature of 20°CDB/15°CWB, and outdoor temperature of 7°CDB/6°CWB.
 Pipe length: 7.5 m; Height difference between outdoor unit and indoor unit: 0 m. Voltage: 230 [V]

Optional parts

*For more details, please refer to the chapter "Optional parts".

External power supply unit: UTZ-GXXA, UTZ-GXXC*
 WLAN adapter: UTY-TFSXZ1, UTY-TFSXJ3, FG-AC-WIF1Z1

Dimensions

(Unit: mm)

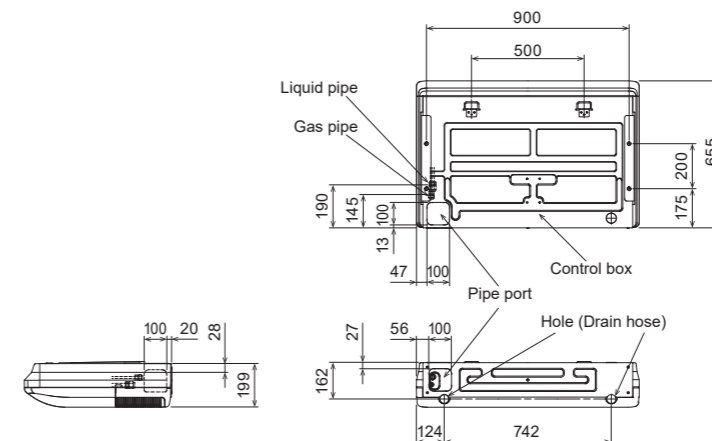

Ceiling



Installation

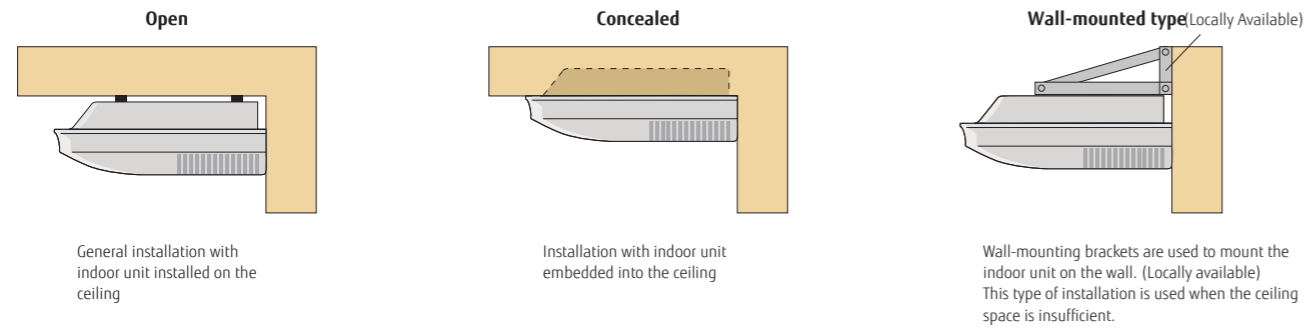

Double auto swing and wide airflow

Auto airflow direction and auto swing

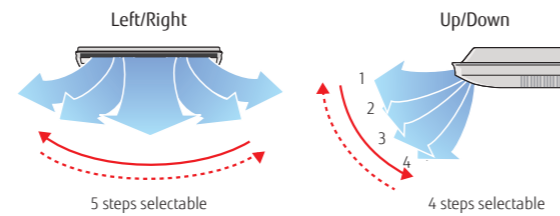

High-power DC fan motor

- High power
- Wide rotation range
- High-efficiency



Long airflow

Long airflow provides comfort in every corner of a large room.

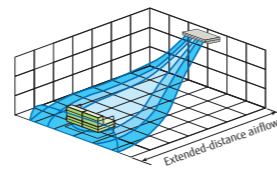

Fresh air intake

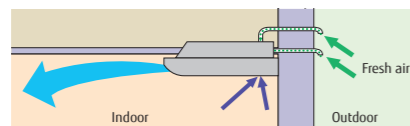

Slim & Compact design



Model: ABHA030GTEH / ABHA036GTEH / ABHA045GTEH / ABHA054GTEH



Specifications

Model name		ABHA030GTEH	ABHA036GTEH	ABHA045GTEH	ABHA054GTEH	
Power source		Single phase, ~230 V, 50 Hz				
Capacity	Cooling	9.0	11.2	12.5	14.0	
	Heating	10.0	12.5	14.0	16.0	
Input power		66	85	131	180	
Airflow rate	High	1,630	1,690	2,010	2,270	
	Med-High	1,520	1,560	1,840	2,070	
	Med	1,420	1,450	1,690	1,860	
	Med-Low	1,320	1,360	1,530	1,660	
	Low	1,220	1,270	1,380	1,470	
Sound pressure level	Quiet	1,140	1,170	1,230	1,280	
	High	42	45	48	51	
	Med-High	40	41	46	49	
	Med	39	39	45	46	
	Med-Low	37	38	41	43	
Net Dimensions (H × W × D)	mm	240 × 1,660 × 700	240 × 1,660 × 700	240 × 1,660 × 700	240 × 1,660 × 700	
	Weight	kg	46	48	48	48
	Connection pipe diameter	Liquid (Flare)	9.52	9.52	9.52	9.52
Gas (Flare)		15.88	15.88	15.88	15.88	
Drain Hose Diameter (I.D./O.D.)		25/32				

Note: Specifications are subject to the following conditions:
Cooling: Indoor temperature of 27°CDB/19°CWB, and outdoor temperature of 35°CDB/24°CWB.
Heating: Indoor temperature of 20°CDB/15°CWB, and outdoor temperature of 7°CDB/6°CWB.
Pipe length: 7.5 m; Height difference between outdoor unit and indoor unit: 0 m. Voltage: 230 [V]

Optional parts

*For more details, please refer to the chapter "Optional parts".

- Drain pump unit: UTR-DPB24T
- Flange: UTD-RF204
- External power supply unit: UTZ-GXXA, UTZ-GXXC*
- WLAN adapter: UTY-TFSXZ1, UTY-TFSXJ3, FG-AC-WIF1Z1

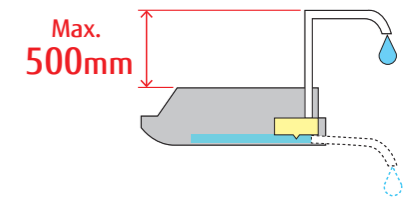

Dimensions

(Unit: mm)

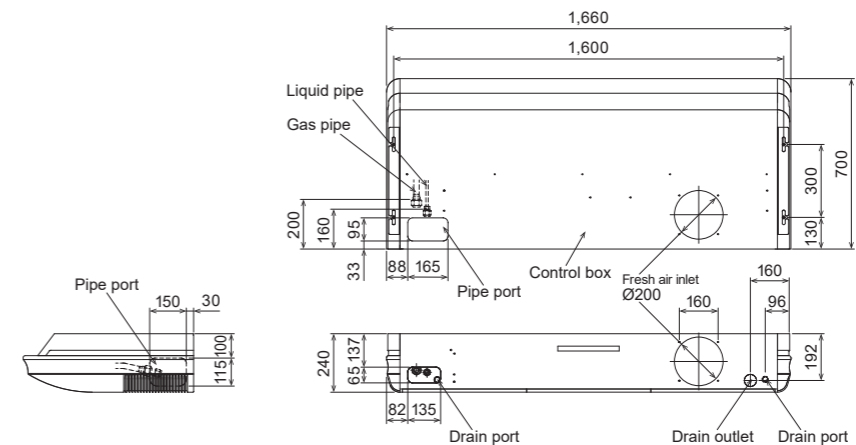

Wall-mounted type



Highly-efficiency, compact design

The 004-014 models share the same design. The high-density and large heat exchanger achieves a highly-efficiency and compact design. The compact body blends in well with conference rooms and offices, providing comfortable air conditioning.

High-density heat exchanger

Slim tube design: 5 mm
Greater heat-exchanging capacity is achieved through the use of a high-density heat exchanger and a sub-heat exchanger.



More comfortable airflow

The unique power diffuser provides comfortable air conditioning.

Heating

The vertical airflow provides powerful floor-level heating.

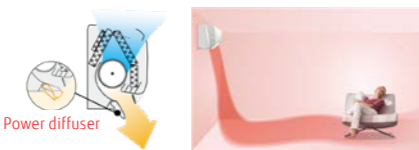

Cooling

The left/right airflow avoids blowing cool air directly at the occupants in a room.



Quiet operation & 6-Step fan speed control

The airflow pattern achieves significant noise reduction. Multistep airflow adjustment to suit the environment

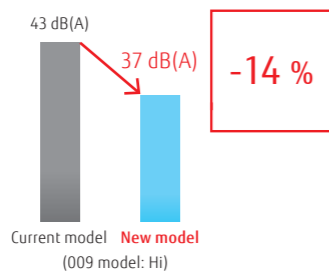

- 6-Step Speed
- High
- Med-High
- Med
- Med-Low
- Low
- Quiet

* Remote controller is compatible with the following:
UTY-RNRGZ5 / UTY-RLRG / UTY-RSRG / UTY-RHRG / UTY-DCGGZ3 / UTY-ALGXZ1 / UTY-APGXZ1

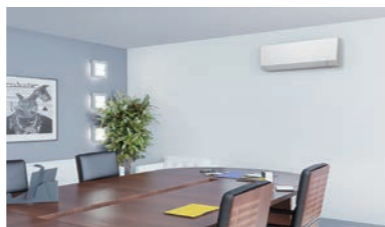

The Human sensor contributes to further energy savings.

Energy saving operation starts automatically by detecting the motion of a person. Two modes of save operation mode and stop mode can be selected.

*If you want to use the Human sensor control' function, you need an setting device that can set the Human sensor control' function. For example: Wired RC (Touch panel).

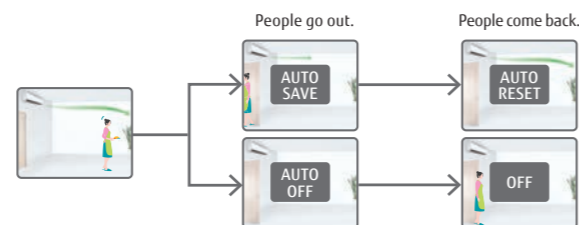

Model: ASHA004GCGH / ASHA007GCGH / ASHA009GCGH
ASHA012GCGH / ASHA014GCGH
[external EEV]
ASHE004GCEH / ASHE007GCEH / ASHE009GCEH
ASHE012GCEH / ASHE014GCEH



Specifications

Model name	ASHA004GCGH	ASHA007GCGH	ASHA009GCGH	ASHA012GCGH	ASHA014GCGH	ASHE004GCEH	ASHE007GCEH	ASHE009GCEH	ASHE012GCEH	ASHE014GCEH	
Power source	Single phase, ~230 V, 50 Hz					Single phase, ~230 V, 50 Hz					
Capacity	Cooling	1.1	2.2	2.8	3.6	4.0	1.1	2.2	2.8	3.6	4.0
	Heating	1.3	2.8	3.2	4.0	4.5	1.3	2.8	3.2	4.0	4.5
Input power	W										
Airflow rate	High	450	550	610	690	800	450	550	610	690	800
	Med-High	430	510	560	610	740	430	510	560	610	740
	Med	400	470	510	560	680	400	470	510	560	680
	Med-Low	380	410	440	530	610	380	410	440	530	610
	Low	360	360	360	470	550	360	360	360	470	550
	Quiet	310	310	310	330	330	310	310	310	330	330
Sound pressure level	High	31	34	37	40	44	31	35	43	40	44
	Med-High	30	32	35	37	42	30	32	38	37	42
	Med	28	30	32	35	40	28	30	34	35	40
	Med-Low	27	28	29	33	37	27	27	29	33	37
	Low	26	26	26	30	34	26	24	24	30	34
	Quiet	22	22	22	24	24	22	22	22	24	24
Net Dimensions (H × W × D)	mm 268 × 840 × 203					mm 268 × 840 × 203					
Weight	kg 8.0 8.5 8.5 8.5 8.5 8.0 8.5 8.5 8.5 8.5										
Connection pipe diameter	Liquid (Flare)	mm 6.35 6.35 6.35 6.35 6.35 6.35 6.35 6.35 6.35 6.35									
	Gas (Flare)	mm 9.52 9.52 9.52 12.70 12.70 9.52 9.52 9.52 12.70 12.70									
Drain Hose Diameter (I.D./O.D.)	13.8/15.8 to16.7					13.8/15.8 to16.7					
EV kit (optional)	-					UTR-EV09XB		UTR-EV14XB			

Note: Specifications are subject to the following conditions:
Cooling: Indoor temperature of 27°CDB/19°CWB, and outdoor temperature of 35°CDB/24°CWB.
Heating: Indoor temperature of 20°CDB/15°CWB, and outdoor temperature of 7°CDB/6°CWB.
Pipe length: 7.5 m; Height difference between outdoor unit and indoor unit: 0 m. Voltage: 230 [V]
When connecting ASH*004G**H, ASH*007G**H, ASH*009G**H to an outdoor unit other than the outdoor unit of the J-IVL Series, the gas pipe diameter should be Ø12.70 mm.

Optional parts

*For more details, please refer to the chapter "Optional parts".

- External power supply unit: UTZ-GXXA, UTZ-GXXC*
- WLAN adapter: UTY-TFSXZ1, UTY-TFSXJ3, FG-AC-WIF1Z1
- Silver Ion Filter: UTR-FA16-5
- Remote sensor kit: UTY-XSZXZ1

Dimensions

(Unit: mm)

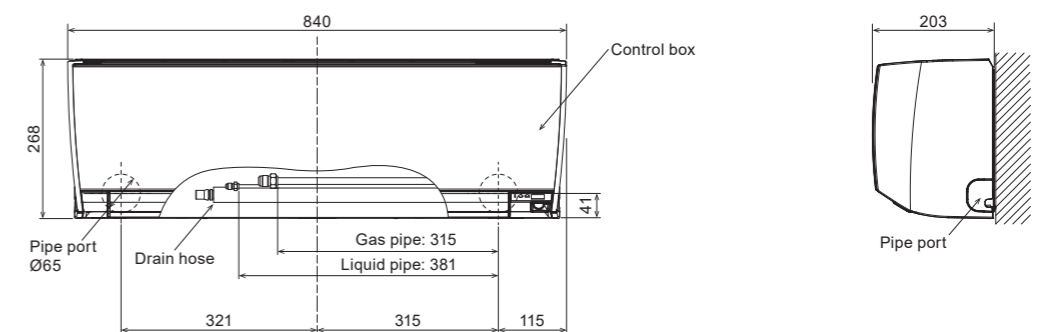

Wall-mounted type



Powerful & Comfort airflow

Powerful Airflow

(ASHA030GTEH)

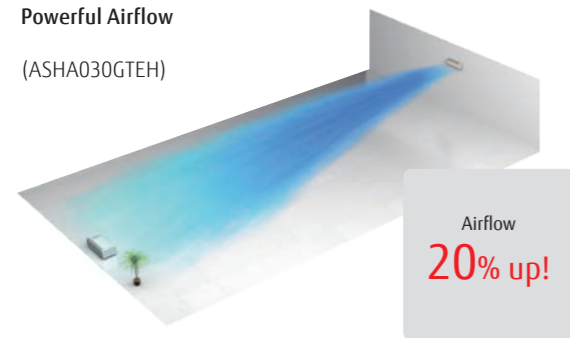

Power diffuser

(ASHA18/24GBCH)

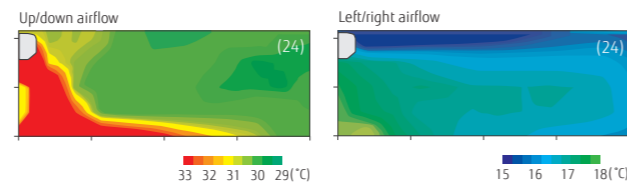

The Human sensor contributes to further energy savings. (ASHA030/034GTEH only)

Energy saving operation starts automatically by detecting the motion of a person. Two modes of save operation mode and stop mode can be selected.

*If you want to use the Human sensor control function, you need an setting device that can set the Human sensor control function. For example: Wired RC (Touch panel).

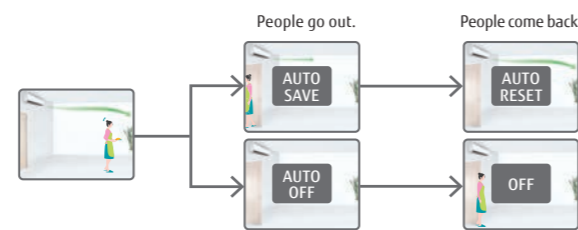

6-step fan speed control for quiet operation

The airflow pattern achieves significant noise reduction. A 6-step sound level setting allows for multiple-step silent operations.

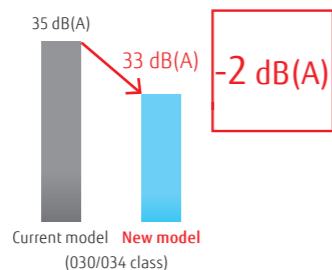

- 6-Step Speed
- High
- Med-High
- Med
- Med-Low
- Low
- Quiet



* Remote controller is compatible with the following: UTY-RNRGZ5 / UTY-RLRG / UTY-RSRG / UTY-RHRG / UTY-DCGGZ3 / UTY-ALGXZ1 / UTY-APGXZ1

Model: ASHA18GBCH / ASHA24GBCH
ASHA030GTEH / ASHA034GTEH



ASHA18/24GBCH



ASHA030/034GTEH

Specifications

Model name		ASHA18GBCH	ASHA24GBCH	ASHA030GTEH	ASHA034GTEH
Power source		Single phase, ~230 V, 50 Hz			
Capacity	Cooling	5.6	7.1	9.0	10.0
	Heating	6.3	8.0	10.0	11.2
Input power		32	60	74	103
Airflow rate	High	840	1,100	1,440	1,620/1,520
	Med-High	-	-	1,200	1,300
	Med	770	910	1,050	1,120
	Med-Low	-	-	940	980
	Low	690	730	890	890
	Quiet	-	-	700	700
Sound pressure level	High	41	48	53	55/54
	Med-High	-	-	49	51
	Med	39	43	45	47
	Med-Low	-	-	42	43
	Low	35	35	39	39
	Quiet	-	-	33	33
Net Dimensions (H × W × D)		mm 320 × 998 × 238	320 × 998 × 238	340 × 1,150 × 280	340 × 1,150 × 280
Weight		kg 15	15	18	18
Connection pipe diameter	Liquid (Flare)	6.35	9.52	9.52	9.52
	Gas (Flare)	12.70	15.88	15.88	15.88
Drain Hose Diameter (I.D./O.D.)		12/16		13.8/15.8 to 16.7	

Note: Specifications are subject to the following conditions:
Cooling: Indoor temperature of 27°CDB/19°CWB, and outdoor temperature of 35°CDB/24°CWB.
Heating: Indoor temperature of 20°CDB/15°CWB, and outdoor temperature of 7°CDB/6°CWB.
Pipe length: 7.5 m; Height difference between outdoor unit and indoor unit: 0 m. Voltage: 230 [V].
When connecting ASHA18GBCH to an outdoor unit other than the outdoor unit of the J-IVL Series, the pipe diameter should be Ø9.52/Ø15.88 mm (Liquid/Gas).

Optional parts

*For more details, please refer to the chapter "Optional parts".

External power supply unit: UTZ-GXXA (030/034), UTZ-GXXC* (030/034) Silver Ion Filter: UTR-FA13-3
WLAN adapter: UTY-TFSXJ3 (030/034), UTY-TFSXZ1 (030/034) Remote sensor kit: UTY-XS2XZ1
FG-RC-WIF122 (18/24), FG-AC-WIF121 (030/034)

Dimensions

(Unit: mm)

Models: ASHA18/ASHA24

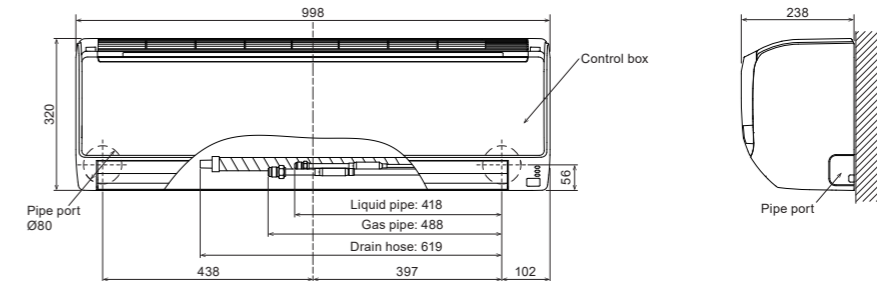

Models: ASHA030/ASHA034

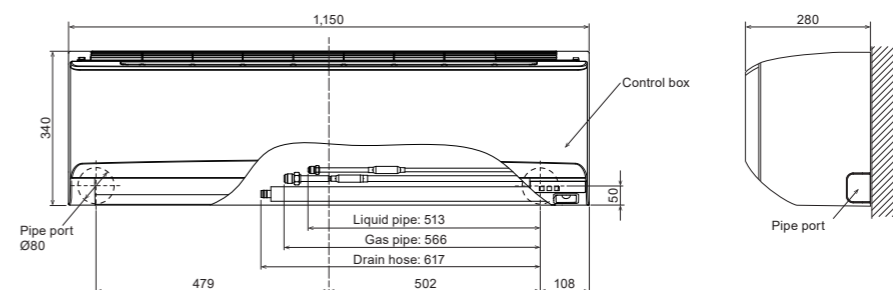

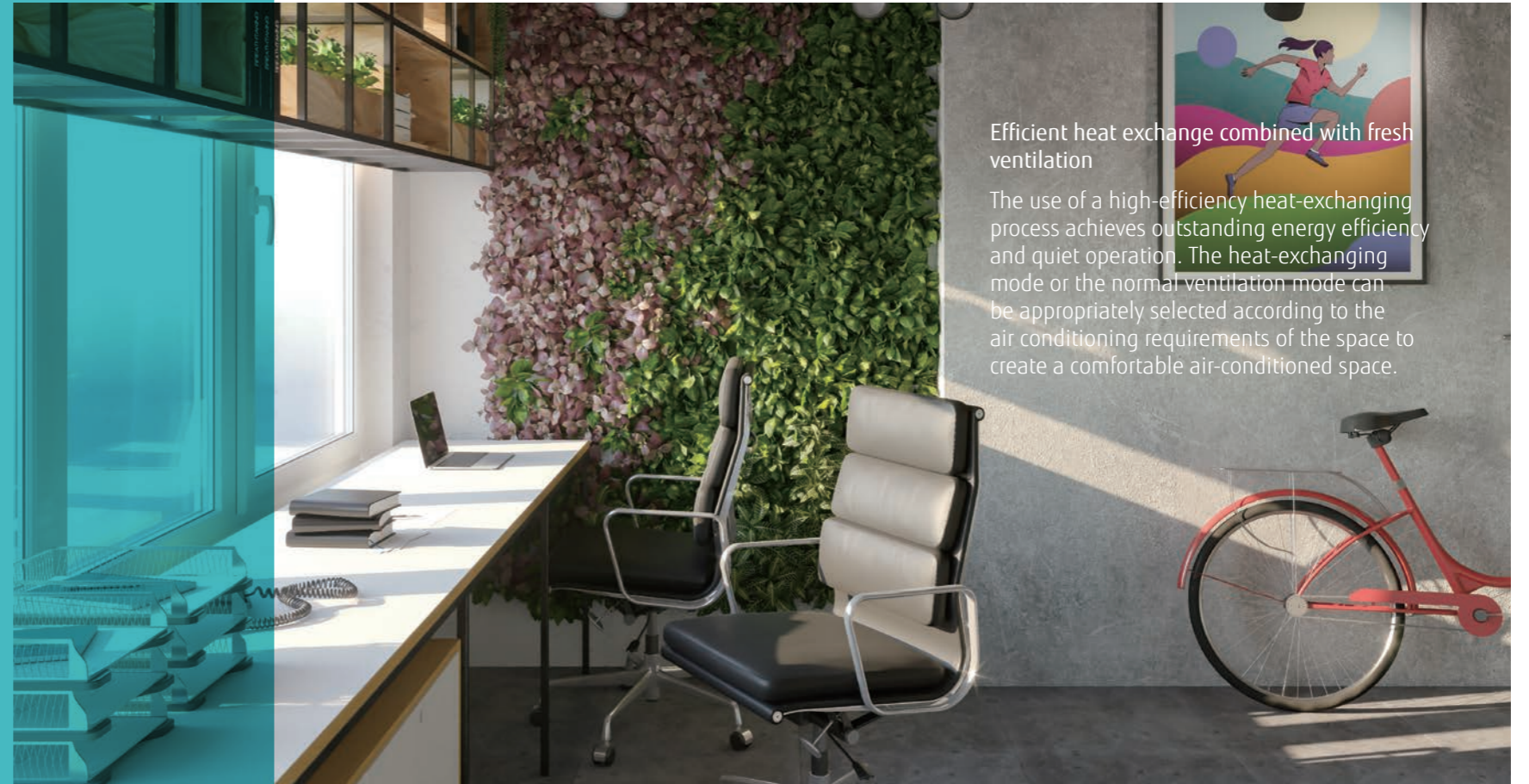

Efficient heat exchange combined with fresh ventilation

The use of a high-efficiency heat-exchanging process achieves outstanding energy efficiency and quiet operation. The heat-exchanging mode or the normal ventilation mode can be appropriately selected according to the air conditioning requirements of the space to create a comfortable air-conditioned space.







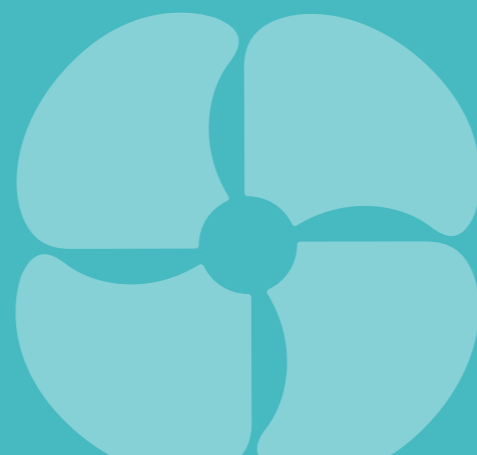



Residential, Commercial & Light Commercial VENTILATION

VENTILATION Lineup

- Vn-002 Energy Recovery Ventilator
- Vn-004 DX kit for Air handling applications
 - for VRF Outdoor unit
- Vn-006 DX kit for Air handling applications
 - for Single Split Outdoor Units



Lineup

Airflow rate (m ³ /h)	250		350		500		800		1000	
Energy Recovery Ventilator										
	UTZ-BD025C		UTZ-BD035C		UTZ-BD050C		UTZ-BD080C		UTZ-BD100C	
Connectable capacity class (kW)	5.0	6.3	8.0	10.0	12.5	14.0	20.0	25.0	40.0	50.0
DX kit for Air handling applications for VRF Outdoor unit										
	EEV unit UTP-VX30A Control unit UTY-VDGX		EEV unit UTP-VX60A Control unit UTY-VDGX		EEV unit UTP-VX90A Control unit UTY-VDGX		EEV unit UTP-VX90A × 2 Control unit UTY-VDGX			
Connectable capacity class (kW)	2.5 - 22.0									
DX kit for Air handling applications for Single Split Outdoor Units										
	UTY-XDZX									

Energy Recovery Ventilator



The energy recovery ventilator unit provides energy efficiency for comfort and improved savings.

Heat exchange ventilation and normal ventilation

Heat exchange ventilation

When a room is cooled or heated, the exhausted cooling or heating energy is recovered by heat exchange ventilation.

Normal ventilation

Used when the indoor space does not require cooling or heating, i.e., when there is little temperature difference between the indoor and outdoor environments.

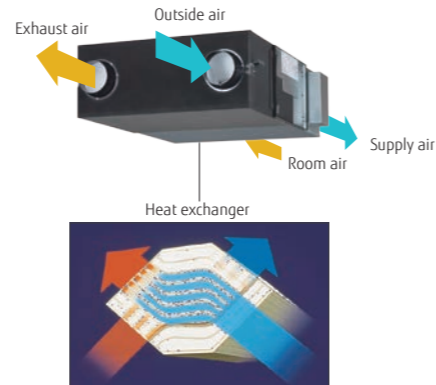

A high-efficiency counter-flow heat-exchanging element is used in the setup.

Energy efficiency and ecology

The use of a counter-flow heat-exchanging element, designed to recover up to 77% of heat from the outgoing air, significantly reduces energy consumption. The air conditioning load is reduced by approximately 20%, which results in substantial savings in energy cost.

Comparison of heat-exchanging elements

Air flows in a straight line through a crossflow element. In contrast, air flows for a longer time (a longer distance) through a counter-flow element to achieve more consistent heat-exchanging performance.

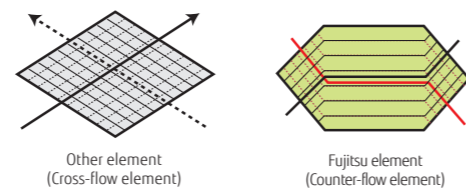

Quiet operation

Significantly lower noise levels are achieved by reducing pressure loss.

25.5dB
(UTZ-BD035C)

Extended range of external static pressure

The use of a powerful fan motor improves the external static pressure. This allows it to be installed in a variety of buildings.

Slim design for easier installation

The use of a counter-flow heat-exchanging element made it possible to design a quieter, slimmer unit.



Reverse-mountable direct air supply and exhaust system

Simplifies the duct design, due to its straight ducts for air supply and exhaust. Since each unit can be mounted facing opposite directions, only one inspection hole is needed for two units. This makes duct work easier and more flexible.

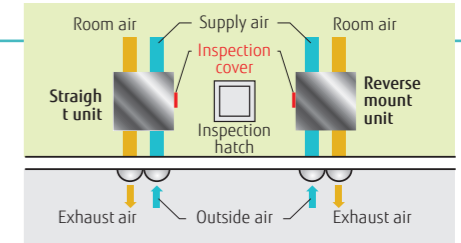

Simple remote operation

Easy operation with connected liquid crystal switch

- Power On/Off
- Air volume High/Low
- Heat exchange ventilation and normal ventilation
- On/Off Timer
- Clean filter display



Model: UTZ-BD025C/UTZ-BD035C/UTZ-BD050C/UTZ-BD080C/UTZ-BD100C

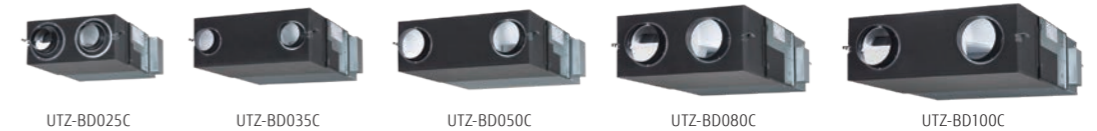

Specifications

Rated flow rate	250 m ³ /h		350 m ³ /h		500 m ³ /h		800 m ³ /h		1000 m ³ /h	
Model name	UTZ-BD025C		UTZ-BD035C		UTZ-BD050C		UTZ-BD080C		UTZ-BD100C	
Power source	Single phase, ~220 to 240 V, 50 Hz									
Heat Exchange Ventilation	Input power	(Extra high)/High/Low	W	128/123/96	190/185/168	289/225/185	418/378/295	464/432/311		
	Airflow rate	(Extra high)/High/Low	m ³ /h	250/25/190	350/350/240	500/500/440	800/800/630	1,000/1,000/700		
	External static pressure	(Extra high)/High/Low	Pa	105/95/45	140/60/45	120/60/35	140/110/55	105/80/75		
	Temperature exchange efficiency	(Extra high)/High/Low	%	75/75/77	75/75/78	75/75/76	75/75/76	75/75/79		
	Energy exchange efficiency cooling	(Extra high)/High/Low	%	63/63/65	66/66/71	62/62/64	65/65/68	65/65/70		
Normal Ventilation	Energy exchange efficiency heat pump	(Extra high)/High/Low	%	70/70/72	69/69/73	67/67/69	71/71/74	71/71/76		
	Sound pressure level	(Extra high)/High/Low	dB*	31.5/30.5/26.5	33.0/31.0/25.5	37.5/35.5/32.5	37.5/37.0/34.5	38.5/37.5/34.5		
	Input power	(Extra high)/High/Low	W	128/123/96	190/185/168	289/225/185	418/378/295	464/432/311		
	Airflow rate	(Extra high)/High/Low	m ³ /h	250/25/190	350/350/240	500/500/440	800/800/630	1,000/1,000/700		
	External static pressure	(Extra high)/High/Low	Pa	105/95/45	140/60/45	120/60/35	140/110/55	105/80/75		
Sound pressure level	(Extra high)/High/Low	dB*	31.5/30.5/26.5	33.0/31.0/25.5	38.5/38.0/32.5	37.5/37.0/34.5	40.5/39.5/36.5			
Dimensions	W × D × H	mm	882 × 599 × 270	1,050 × 804 × 317	1,090 × 904 × 317	1,322 × 884 × 388	1,322 × 1,134 × 388			
Weight		kg	29	49	57	71	83			
Outlet duct diameter		mm	150	150	200	250	250			
Operating range		°C	-10 to 40	-10 to 40	-10 to 40	-10 to 40	-10 to 40			
Maximum humidity		%	85	85	85	85	85			

* Noise level measured 1.5 m below the center of the unit

Dimensions

(Unit: mm)

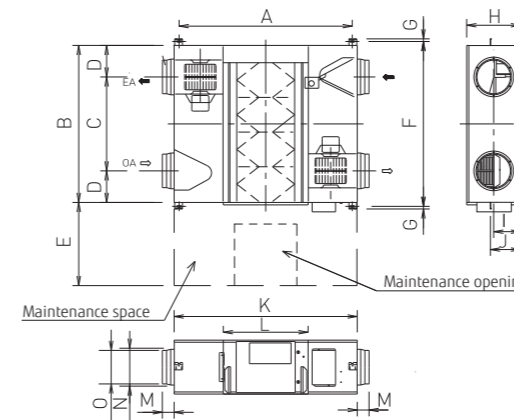

	UTZ-BD025C	UTZ-BD035C	UTZ-BD050C	UTZ-BD080C	UTZ-BD100C
A	810	978	1,018	1,250	1,250
B	599	804	904	884	1,134
C	315	580	640	428	678
D	142	112	132	228	228
E	600	600	600	600	600
F	655	860	960	940	1,190
G	19	19	19	19	19
H	270	317	317	388	388
I	135	159	159	194	194
J	159	182	182	218	218
K	882	1,050	1,090	1,322	1,322
L	414	470	470	612	612
M	95	70	70	85	85
N	Ø164	Ø164	Ø210	Ø258	Ø258
O	Ø144	Ø144	Ø194	Ø242	Ø242

DX kit for Air handling applications for VRF Outdoor unit



With these kits, air handling units (AHUs) and fan coil units (FCUs) from other manufacturers can be incorporated into Fujitsu General VRF systems, or one AHU can be connected to one Fujitsu General VRF dedicated outdoor unit to control outdoor ventilation and room temperatures.

Multiple temperature sensors optimally control an Air handling unit and a fan coil unit.

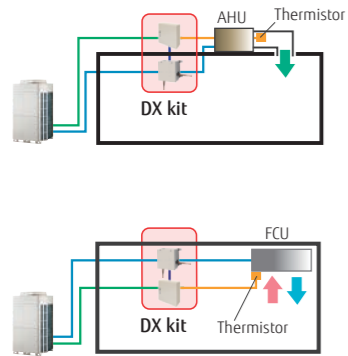

When connected to an Air handling unit, the temperature of supply air is controlled by a discharge air sensor.

When connected to a fan coil unit, the room temperature is controlled by the discharge air sensor.

Application as part of a VRF system

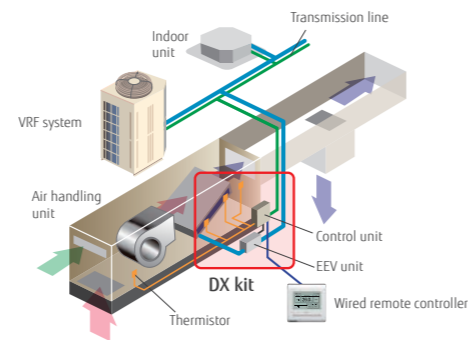

Supports a wide range of capacity classes

- Two EEV units can be connected in parallel to large-capacity units of up to 20 HP (50 kW). (UTP-LX180A separation tube required)
- Connectable capacity range: 5 kW to 50 kW

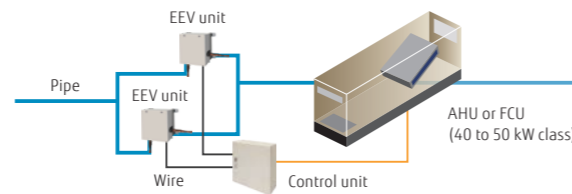

A variety of control options that meet application requirements

Central control enabled by our VRF controllers or central management controllers

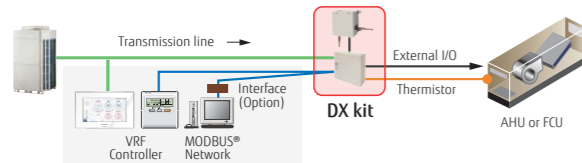

Central control from external controllers

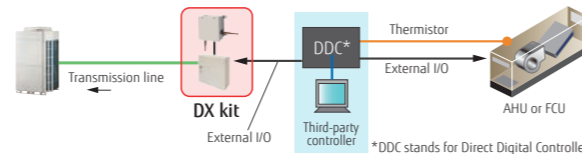

*DDC stands for Direct Digital Controller

Summary of functions

Inputs

- On/Off
- Setting temperature
- Capacity demand
- Heating/Cooling operation modes
- Fault information

Outputs

- On/Off indication
- Fan On/Off indication
- Thermostat On/Off indication
- Defrost indication
- Fault indication

MODBUS® Control

Can be controlled via a MODBUS®-enabled BMS using an optional interface.

Installation requirements

- Connectable VRF Series: All VRF Series
- Capacity range of connectable DX kit systems with outdoor units: 50 to 100% of capacity
- Capacity range of connectable DX kit systems with indoor units: 30% or less of capacity
- Max. wire length from a control unit: 10 m
- Max. pipe length between EEV unit and indoor unit: 5 m
- A control unit (IP54 class) and an EEV unit can be installed outdoors.

Connectable capacity

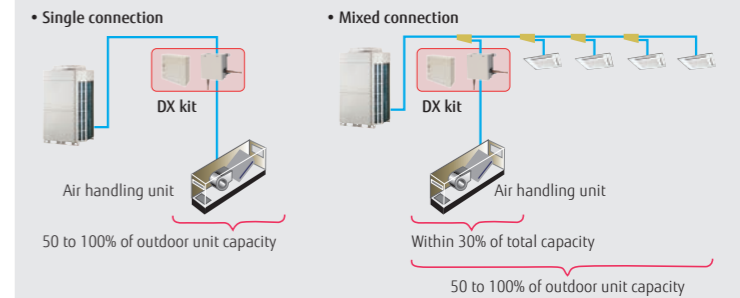

Pipe and wire length

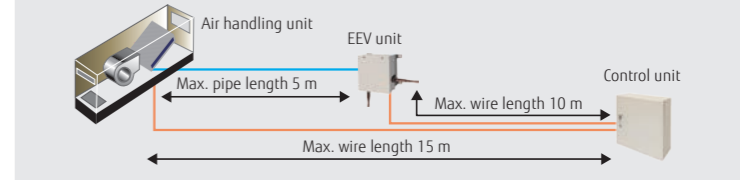

Optional separation tube to connect two EEV units: UTP-LX180A



Control unit: UTY-VDGX EEV unit: UTP-VX30A/UTP-VX60A/UTP-VX90A

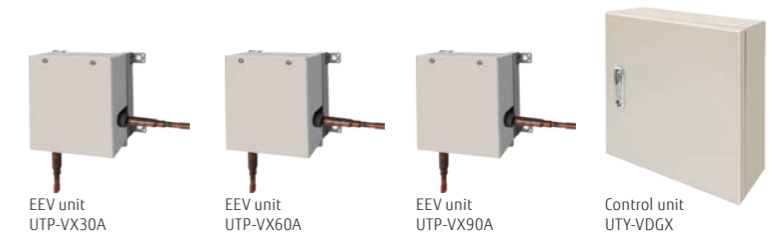

Specifications

Connectable capacity class		5.0 kW	6.3 kW	8.0 kW	10.0 kW	12.5 kW	14.0 kW	20.0 kW	25.0 kW	40.0 kW	50.0 kW
Capacity	Cooling	5.6	6.3	8.0	10.0	12.5	14.0	22.4	25.0	40.0	50.4
	Heating	6.3	7.1	9.0	11.2	14.0	16.0	25.0	28.0	45.0	56.5

Control unit		UTY-VDGX	
Power source		230/1/50	
Dimensions (H × W × D)	mm	400 × 400 × 120	

EEV unit		UTP-VX30A	UTP-VX60A	UTP-VX90A	UTP-VX90A × 2
Connection pipe diameter (Liquid)	mm	Ø9.53	Ø12.70	Ø12.70	Ø12.70
Dimensions (H × W × D)	mm	160 × 220 × 90			

Note: Specifications are based on the following conditions.
Cooling: Indoor temperature of 27°CDB/19°CWB, and outdoor temperature of 35°CDB/24°CWB.
Heating: Indoor temperature of 20°CDB/15°CWB, and outdoor temperature of 7°CDB/6°CWB.
Pipe length: 7.5 m Voltage: 230 [V].

DX kit for Air handling applications for Single Split Outdoor Units



With this kit, other manufacturers' Air handling units (AHUs) and fan coil units (FCUs) can be incorporated into Fujitsu General Split outdoor units.

Flexible connectivity

This kit allows connections to third-party equipment. This control unit can also be used in conjunction with Fujitsu General single-split outdoor units, providing a perfect solution when a stand-alone Air handling unit is needed.

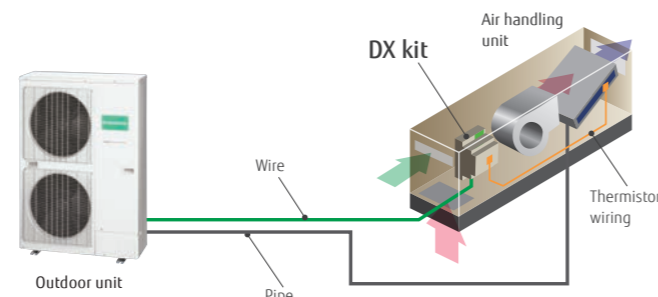

Supports a wide range of capacity classes

Capable of connecting large capacities in the range of 2.5 kW to 22.0 kW (Nominal)



Mobile devices allow for operation from anywhere

Can be operated and managed remotely using your smartphone or tablet.

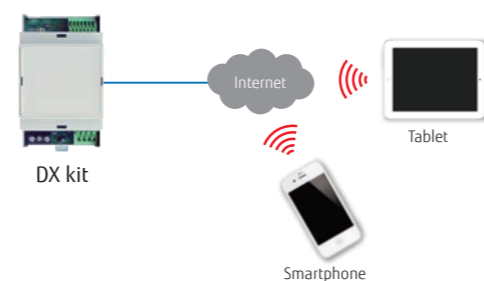

Summary of functions

Inputs

- On/Off
- Heating/Cooling operation modes
- Capacity demand (analogue 0 to 10 V)
- Heat exchanger temperature

Outputs

- Status of Compressor, Defrost, and Errors (Potential free relays)
- Status indicator with LED

Wireless LAN Control

Wireless LAN control through cloud connectivity enables secure remote monitoring and control from anywhere.

Easy installation

- Compact DIN rail mountable enclosure for easy installation
- No expansion device required
- No separate external power supply required

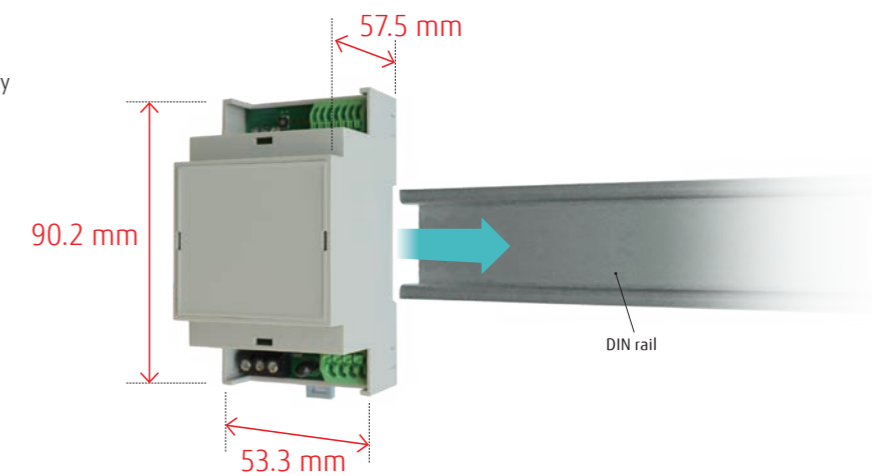

Model: UTY-XDZX



Specifications

R410A models

Capacity (Nominal)	kW		12	14	18	24	30	36	45	54	60	72	90
	Cooling		3.5	4.3	5.2	6.8	8.5	9.4	12.1	13.3	15.0	19.0	22.0
Heating		4.1	5.0	6.0	7.8	10.0	10.8	13.3	15.8	18.0	22.4	27.0	

R32 models

Capacity (Nominal)	kW		09	12	14	18	22	24	30	36	45	54
	Cooling		2.5	3.5	4.3	5.2	6.0	6.8	8.5	9.4	12.1	13.3
Heating		3.2	4.1	5.0	6.0	7.0	7.5	10.0	10.8	13.3	15.8	

Model name		UTY-XDZX	
Power source	V/Ø/Hz	230/1/50	
Dimensions (H × W × D)	mm	90.2 × 53.3 × 57.5	
Weight	g	110	

Note: Specifications are based on the following conditions.
Cooling: Indoor temperature of 27°CDB/19°CWB, and outdoor temperature of 35°CDB/24°CWB.
Heating: Indoor temperature of 20°CDB/15°CWB, and outdoor temperature of 7°CDB/6°CWB.
Pipe length: 5.0 m Voltage: 230 [V].

Light Commercial & Commercial, Residential CONTROL SYSTEM & OPTIONAL PARTS

- C-002 Control System Overview
- C-006 Best control solution for each building structure
- C-008 Comparison table of controllers
- C-050 Controller System List
- C-058 Optional Parts Overview
- C-066 Optional parts list
- C-070 Function list

A wide product lineup to meet a variety of needs

We can flexibly meet customer needs through a variety of offerings including wired and wireless individual remote controllers, central remote controllers that simultaneously control multiple indoor units, and a variety of converters that link with other systems.

CONTROL SYSTEM

INDIVIDUAL CONTROL

- C-010 Wired remote controller (Design type)
- C-012 Wired remote controller (with touch panel)
- C-014 Wired remote controller / Compact wired remote controller
- C-015 Wired remote controller
- C-016 Simple remote controller
- C-017 Wireless remote controller
- C-018 IR receiver unit

CONVERTERS/ADAPTERS

- C-020 WLAN adapter
- C-024 Multiple protocol WLAN adapter

CENTRALIZED CONTROL





- C-025 Home central remote controller
- C-026 Central remote controller
- C-028 Touch panel controller
- C-032 System controller Software / System controller lite Software

CONVERTERS/ADAPTERS

- C-036 MODBUS® converter for indoor unit
- C-037 MODBUS® interface
- C-038 MODBUS® converter for VRF
- C-039 BACnet® interface
- C-040 BACnet® gateway Software
- C-041 BACnet® gateway Hardware
- C-042 BACnet®/MODBUS® router
- C-043 BACnet®/MODBUS® cloud device
- C-044 KNX® converter for indoor unit / KNX® converter for VRF
- C-045 KNX® interface
- C-046 Network converter for single-split type
- C-047 Network converter for LONWORKS™
- C-048 External switch controller / Signal amplifier

Optional parts

- C-060 Silver ion filter
- C-061 Auto louver grille kit
- C-062 Pressure sensor kit
- C-063 External power supply unit
AIR BEAM radiation air outlet unit
- C-064 Gas sensor kit
- C-074 Separation tube and other piping products

-  SPLIT
-  MULTI-SPLIT
-  VRF J Series
-  VRF V Series

Control System Overview

for Split & Multi-split

All indoor units* are equipped with a wireless or wired remote controller as standard. Additional options are available, such as individual remote controllers and central remote controllers. The easy-to-operate central remote controller makes it simple to control the operation mode, temperature, airflow volume, timer, and other functions of each indoor unit from a single location.

* Except for some products



Air Conditioning Individual control

NEW **Wired remote controller**
A built-in thermo sensor monitors and controls room temperature accurately.

Wireless remote controller
Simple and versatile operations with a choice of 4 different types of timers

Simple remote controller
Compact remote controller with basic functionality

For Ceiling type
IR receiver unit

For Duct type
IR receiver unit

For Cassette type
IR receiver unit

This IR receiver unit enables a wireless remote controller to control a duct-type indoor unit.

Air Conditioning Centralized control

Home central remote controller for 5 & 6-unit Multi-split type
Enables individual and central control.

Converters/Adapters

For external control via BMS/Home Automation Systems

- MODBUS® converter for indoor units** UTY-VMSX
- MODBUS® interface for indoor units** Intesis
- KNX® converter for indoor units** UTY-VK SX
- KNX® interface for indoor units** Intesis
- WLAN adapter** Intesis
- Network converter**
DC power supply type UTY-VTGX
AC power supply type UTY-VTGXV

Online Control (Wireless Control via Smartphone/Tablet)

With the WLAN adapter and the AIRSTAGE Mobile app, you can control the heating and cooling of your home anytime, anywhere.

WLAN adapter
The dedicated WLAN adapter enables the air conditioner to be operated by smartphone or tablet computer.

Simple, user-friendly interface design
The designed screen display makes it easier than ever to operate.

AIRSTAGE Mobile **Download Free** (Available on the App Store and Google play)

Control System Overview

for VRF

To meet the diverse needs of customers, we offer a variety of control options for our VRF systems, such as individual control, centralized control, and building management system (BMS) options.

Air Conditioning Individual control

NEW **Wired remote controller (Design type)**
UTY-RVRG

Wired remote controller (with touch panel)
UTY-RNRGZ5

Wired remote controller
UTY-RLRG

Compact wired remote controller
UTY-RCRGZ1

Simple remote controller
UTY-RSRG
UTY-RHRG
Without operation mode

NEW **Wireless Remote Controller**
UTY-LNVG
UTY-LNHG

IR receiver unit
UTB-YWC for duct type
UTY-TRHX for One-way flow cassette Series/3D-flow cassette Series/duct type
UTY-LBHDX for Circular flow cassette Series

Air Conditioning Centralized control

System controller (Software)
UTY-APGXZ1/UTY-ALGXZ1 (Lite version) **Up to 1600^{*2} Indoor units**

*1: Echelon® U10 USB Network Interface
*2: The Lite version controls up to 400 indoor units.

Touch panel controller
UTY-DTGGZ1 **Up to 400 Indoor units**

NEW **Central remote controller**
UTY-DCGGZ3 **Up to 100 Indoor units**



Converters/Adapters

For external control via BMS/Home Automation Systems

BACnet® gateway
UTY-ABGXZ1 **Software**

VTY-VBGX **Hardware**

BACnet® interface for Indoor units
FG-IR-BMG1Z1

Network converter (For LONWORKS™)
UTY-VLGX

MODBUS® converter for Indoor units
UTY-VMSX

for VRF
UTY-VMGX

KNX® converter for Indoor units
UTY-VKSX

for VRF
UTY-VKGX

WLAN adapter
UTY-TFSXJ3 / UTY-TFSXZ1

External switch controller
UTY-TERX

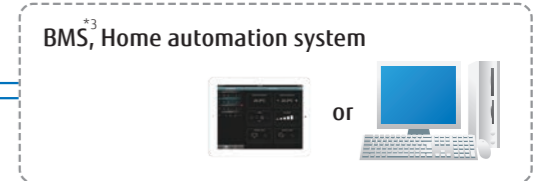

*3: BMS/BAS: Building Management System/Building Automation System

Converters/Adapters for system expansion

Network converter DC power supply type
UTY-VTGX Single split

Network converter AC power supply type
UTY-VTGXV Single split

Signal amplifier
UTY-VSGXZ1



Best control solution for each building structure

Fujitsu General provides the best control solutions suitable for various building structures.

SHOP

Type	Individual control			Centralized control			Integrating control (Interface)				
	Wired remote controller	Central remote controller	Touch panel controller	System controller	Network converter for LONWORKS™	MODBUS® Converter	KNX® converter				
	UTY-RVRG UTY-RNRGZ5 UTY-RLRG UTY-RVNGM UTY-RCRGZ1	UTY-DCGGZ3	UTY-DTGGZ1	UTY-APGXZ1 UTY-ALGXZ1	UTY-VLGX	UTY-VMGX	UTY-VKGX				
Automatic control of air conditioning (Schedule timer, Weekly timer, etc.)	•	•	•	•							
Controls limited to staff: Remote controller prohibition, Setting temperature range limitation, etc.		•	•	•	•	•	•				
Group control		•	•	•							
Advanced energy saving: Peak cut, Operation of indoor unit rotation, etc.				•							
Remote monitoring management		•	•	•							
Manage multiple sites		•	•	•							
Monitor energy consumption				•							
Control third-party products				•							
Integrate Fujitsu General air conditioning into BMS					•	•	•				















HOTEL

Type	Individual control			Centralized control			Integrating control (Interface)				
	Wired remote controller	Simple remote controller	Wireless remote controller	Central remote controller	Touch panel controller	System controller	BACnet® gateway	Network converter for LONWORKS™	MODBUS® converter	KNX® converter	External switch controller
	UTY-RVRG UTY-RNRGZ5 UTY-RLRG UTY-RCRGZ1	UTY-RSRG UTY-RHRG	UTY-LNVG UTY-LNHG UTY-LNTG	UTY-DCGGZ3	UTY-DTGGZ1	UTY-APGXZ1 UTY-ALGXZ1	UTY-ABGXZ1 UTY-VBGX	UTY-VLGX	UTY-VMGX	UTY-VKGX	UTY-TERX
Local control for hotel guests	•	•	•								
Centralized air conditioning control for common areas				•	•	•	•	•	•	•	
Limited control for hotel guests				•	•	•	•	•	•	•	
Remote monitoring management				•	•	•					
Advanced energy saving: Peak cut, Operation of indoor unit rotation, etc.						•	•				
Monitor energy consumption						•					
Control third-party products						•					
Integrate Fujitsu General air conditioning into BMS							•	•	•	•	
Interlock with window contact											•
Interlock with key card											•

OFFICE

Type	Individual control			Centralized control			Integrating control (Interface)				
	Wired remote controller	Simple remote controller	Wireless remote controller	Central remote controller	Touch panel controller	System controller	BACnet® gateway	Network converter for LONWORKS™	MODBUS® converter	KNX® converter	External switch controller
	UTY-RVRG UTY-RNRGZ5 UTY-RLRG UTY-RCRGZ1	UTY-RSRG UTY-RHRG	UTY-LNVG UTY-LNHG UTY-LNTG	UTY-DCGGZ3	UTY-DTGGZ1	UTY-APGXZ1 UTY-ALGXZ1	UTY-ABGXZ1 UTY-VBGX	UTY-VLGX	UTY-VMGX	UTY-VKGX	UTY-TERX
Local control for office staff	•	•	•	•							
Automatic control of air conditioning (Schedule timer, Weekly timer, etc.)	•		•	•	•	•	•				
Centralized air conditioning control for management				•	•	•	•	•	•	•	
Controls limited to staff: Remote controller prohibition, Setting temperature range limitation, etc.				•	•	•	•	•	•	•	
Advanced energy saving: Peak cut, Operation of indoor unit rotation, etc.						•	•				
Remote monitoring management				•	•	•					
Electricity charge apportionment					•	•	•				
Monitor energy consumption						•					
Control third-party products						•					
Integrate Fujitsu General air conditioning into BMS							•	•	•	•	
Interlock with door contact											•
Interlock with Human sensor for meeting room				•							•

Comparison table of controllers

Item																
	Wired remote controller (Design type)	Wired remote controller (with touch panel)	Wired remote controller	Wired remote controller	Compact wired remote controller	Simple Remote Controller		Simple remote controller*1	Wireless remote controller	Wireless remote controller	Wireless remote controller	Home central remote controller (for 5/6-unit multi-split type)	Central remote controller	Touch panel controller	System controller Lite Software	System controller Software
Model name	UTY-RVRG	UTY-RNRGZ5	UTY-RLRG	UTY-RVNGM	UTY-RCRGZ1	UTY-RSRG		UTY-RHRG	UTY-LNTG	UTY-LNVG	UTY-LNHG	UTY-DMMGM	UTY-DCGGZ3	UTY-DTGGZ1	UTY-ALGXZ1	UTY-APGXZ1
Maximum number of controllable remote controller groups	1	1	1	1	1	1		1	1	1	1	1	100	400	400	1600
Maximum number of controllable indoor units	16	16	16	16	1	16		16	16	16	16	8	100	400	400	1600
Maximum number of controllable groups	-	-	-	-	-	-		-	-	-	-	-	50	400	400	1600
Air conditioning control functions	ON/OFF	●	●	●	●	●		●	●	●	●	●	●	●	●	●
	Operation mode setting	●	●	●	●	●		-	●	●	●	●	●	●	●	●
	Fan speed control	●	●	●	●	●		●	●	●	●	●	●	●	●	●
	Room temperature setting	●	●	●	●	●		●	●	●	●	●	●	●	●	●
	Setting temperature range limitation	●	●	●	●	-		●	-	-	-	-	●	●	●	●
	Test operation	●	●	●	●	●		●	●	●	●	●	-	●	●	-
	Vertical louver setting	●	●	●	●	●		●	●	●	●	●	-	●	●	●
	Horizontal louver setting	●	●	●	●	●		-	-	●	●	●	-	●	●	●
	Individual louver control	●	●	-	-	●		-	-	-	-	-	-	●*3	-	-
	Group setting	-	-	-	-	-		-	-	-	-	-	-	●	●	●
	Remote controller prohibition	-	-	-	-	-		-	-	-	-	-	●	●	●	●
	Anti-freeze setting	●	●	-	-	●		-	-	-	-	-	●	●	●	●
	Set temperature auto return	●	●	●	●	-		-	-	-	-	-	-	●	-	-
	Economy mode setting	●	●	●	●	●		-	●	●	●	●	●	●	●	●
	Human sensor control	●	●	-	-	-		-	-	-	-	-	●	●	●	●
	Displayed items	Error	●	●	●	●	●		●	-	-	-	●	●	●	●
Defrosting		●	●	●	●	●		●	-	-	-	-	●	●	●	●
Current time		●	●	●	●	-		-	●	●	●	●	●	●	●	●
Day of week		●	●	●	●	-		-	-	-	-	-	●	●	●	●
Remote controller prohibition		●	●	●	●	●		●	-	-	-	●	●	●	●	●
Address display		●	●	●	●	●		●	-	-	-	-	-	●	●	●
Room temperature		●	●	-	●	●		●	-	-	-	-	●*4	●*4	●*4	●*4
Multiple language support		●	●	-	●	-		-	-	-	-	-	●	●	●	●
Setting for daylight saving time		●	●	-	●	-		-	-	-	-	-	●	●	●	●
Name registration		●	●	-	-	-		-	-	-	-	-	●	●	●	●
Backlighting		●	●	-	●	●		●	-	●	-	●	●	●	-	-
2D floor layout/3D building display		-	-	-	-	-		-	-	-	-	-	-	-	-	●
Refrigerant leak detector		-	-	-	-	-		-	-	-	-	-	●	●	●	●
Refrigerant Cycle Monitor		●	●	-	-	-		-	-	-	-	-	-	-	-	-
Logo Display		●	-	-	-	-		-	-	-	-	-	-	-	-	-
Limited Visibility of Settings		●	-	-	-	-		-	-	-	-	-	-	-	-	-
Timer	Schedule timer	Period: Week ON/OFF, Temp, Low noise mode*5, Times per day	Week	Week	Week	Week		-	-	-	-	Week	Year	Year	Year	Year
	ON/OFF timer	8	8	4	8	-		-	-	-	-	4	20	20	144	144
	Sleep timer	-	●	●	●	●(OFF only)		-	●	●	●	-	-	-	-	-
	Program timer	-	-	-	-	-		-	●	●	●	-	-	-	-	-
	Auto-off timer	●	●	●	●	-		-	-	-	-	-	●	●	-	-
	Day off	●	●	●	●	-		-	-	-	-	●	●	●	●	●
Minimum unit of timer setting (minutes)	1 • 10	10 • 30	30	30	-		-	5	5	5	5	10	10	10	10	
Control	Remote monitoring management system	-	-	-	-	-		-	-	-	-	-	●	●	●	●
	Electricity charge apportionment	-	-	-	-	-		-	-	-	-	-	○	○	○	○
	Error history	●	●	●	●	-		-	-	-	-	-	●	●	●	●
	Emergency stop	-	-	-	-	-		-	-	-	-	-	●*2	●*2	-	-
	Remote monitoring management	-	-	-	-	-		-	-	-	-	-	●	●	○	○
	Energy-saving management	-	-	-	-	-		-	-	-	-	-	-	-	○	○
	E-mail notification in case of failure	-	-	-	-	-		-	-	-	-	-	●	●	●	●
Key lock	● Child lock	● Child lock	● Child lock	● Child lock	-		-	-	-	-	● Child lock	● Password setting	● Password setting	● Password setting	● Password setting	
Low noise mode	-	-	-	-	-		-	-	-	-	●	●	●	●	●	

*1 "Operation mode" setting not available.
 *2 Available only for external input control.
 *3 Monitoring sites can be set up.
 The main unit side can only be operated to cancel the settings.
 *4 Available only when using Wired remote controller.
 *5 UTY-DCGGZ3 only
 ●: Supported ○: Optional function -: Unsupported

Wired remote controller (Design type)

UTY-RVRG



NEW



Up to 16 indoor units
Up to 1 group



GOOD DESIGN AWARD 2022

Simple and stylish design that harmonizes with the space

- The new stylish design controller, UTY-RVRG, enables intuitive operation with touch screen. It is compatible with many 2-wired indoor units.

Harmonizes with the Installation Space

When not in use, the controller is a part of the interior décor. This is achieved by using mirrors, glass, and clear panels, and it appears to be one with the wall. The sleek and stylish design won the 2022 Good Design Award and was selected as a finalist for the 2023 IDEA award.



Intuitive operation

The touch screen is easily operated by swiping vertically and horizontally, and users can operate the controller without using manuals.



Status LED Colors

When not in use, the operation mode is indicated through LED lamp colors shown under the controller. The LED lamp can be switched ON and OFF to avoid glare at night.



Features: Wired Remote Controller (Design type)

Refrigerant cycle monitor

The controller will display specific sensor values of outdoor and indoor units for maintenance and service support.

- * Display screen example
- * This function is only supported by split units, using the H-Serial communication protocol! Example: ASHH30KMTB



Logo Display

The controller can display hotel logos when not in use. Images are sent via Bluetooth® connection where data is saved in the flash memory built into each controller.

* Color display available

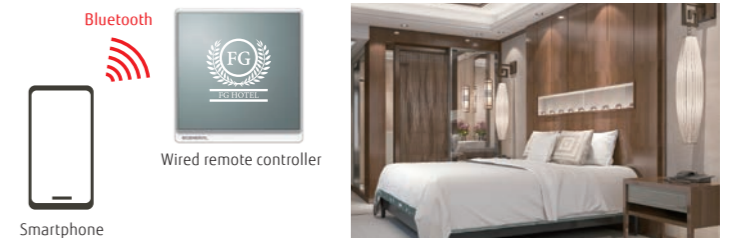

AIRSTAGE Remo Set application (free download)

Set up your new Wired Remote Controller via Bluetooth from your smartphone (or directly at the controller).

- Features:
- Initial configuration
 - Function setting
 - Custom logo import
 - Copy settings between controllers

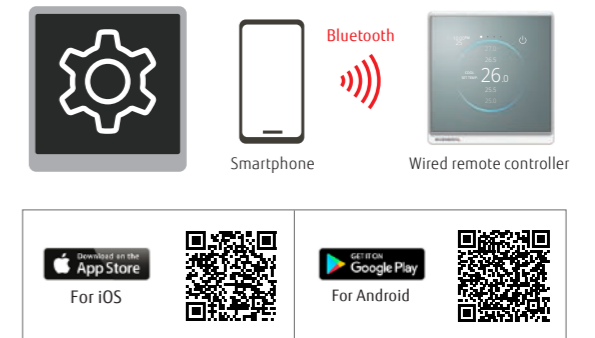

Initial Settings / Indoor Unit Function

The initial controller settings and indoor unit function settings can be sent from a smartphone by pairing with the controller via Bluetooth. It also can read the setting values of a paired controller, and send a copy of them to one or more additional controllers, significantly reducing installation time.

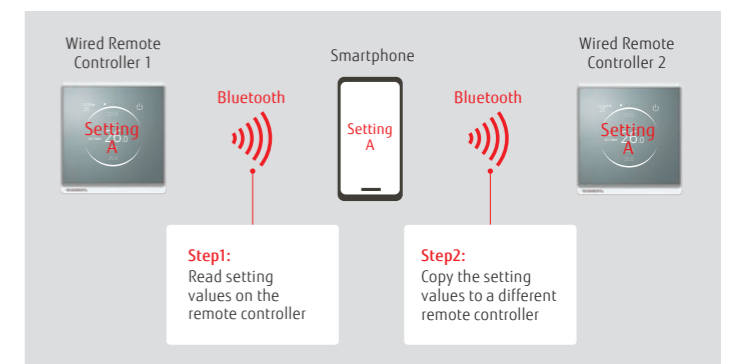

*Smartphone : Wired Remote Controller = 1 : 1

Specifications

Model name	UTY-RVRG
Power Source	DC12V
Dimensions (H × W × D) (mm)	121.5 × 116 × 26
Weight (g)	225

Wired remote controller (with touch panel)

UTY-RNRGZ5



Up to **16** indoor units
Up to **1** group

Easy operation due to large high-resolution STN-LCD touch panel screen

- Touch screen LCD
- Built-in daily/weekly timer (ON/OFF, temperature, modes)
- Backlit screen for easy operation in the dark.
- Room temperature display
- Controls up to 16 indoor units
- Supports 12 languages: Chinese, Dutch, English, French, German, Greek, Italian, Polish, Portuguese, Russian, Spanish, and Turkish
- Nonpolar 2-core type

High performance and compact size

A single remote controller controls each connected indoor unit and provides a weekly timer function and a variety of energy-saving options.



Accurate control for comfort

A thermo sensor built into the remote controller monitors room temperature accurately.

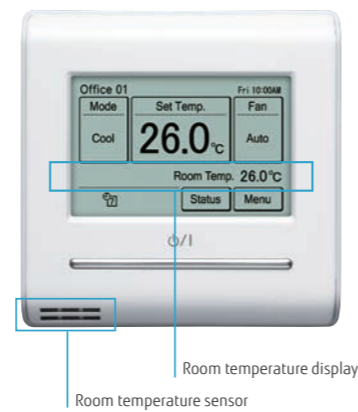

Energy saving controls

Custom Auto

- Maintains 2 separate setpoints for heating and cooling operations.
- Automatically switches between heating and cooling modes.

* Not available for some models

Auto-off timer

- While the Auto-off timer is activated, if the set off time is specified as, for example, one hour, the power will automatically turn off one hour after the start of operation.
- A desired time frame can be specified for the Auto-off timer.
- The off-time can be set from 30 to 240 minutes.

2-setting weekly timer

Set temperature auto return

Setting temperature range limitation

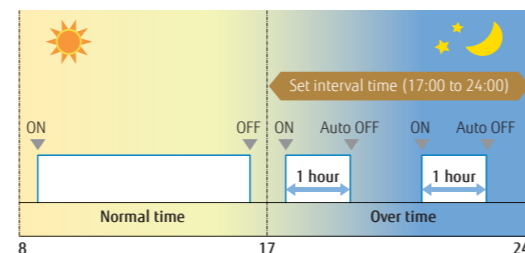
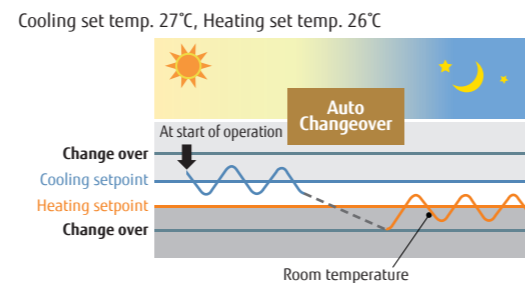

e.g.) Between 17:00 and 24:00 (over time hours), when the 1 hour set off time has elapsed, the system will automatically turn off the indoor unit as it

Features: Wired Remote Controller (Touch Panel)

Refrigerant cycle monitor (Option)

Wired Remote Controller (Touch Panel) will support to display some sensor values for maintenance and service support.

* This function is only supported by split units, using the H-Serial communication protocol! Example: ASHH30KMTB

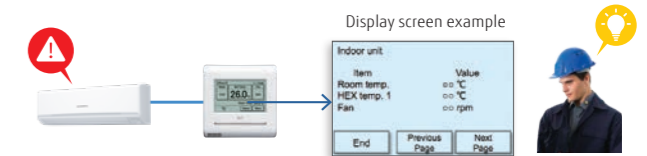

Multi System Control*1

1) Lead Lag Operation

Standby Indoor Unit can be selected in lead lag operation. By this, the Indoor units will last longer than operating by nonstop.

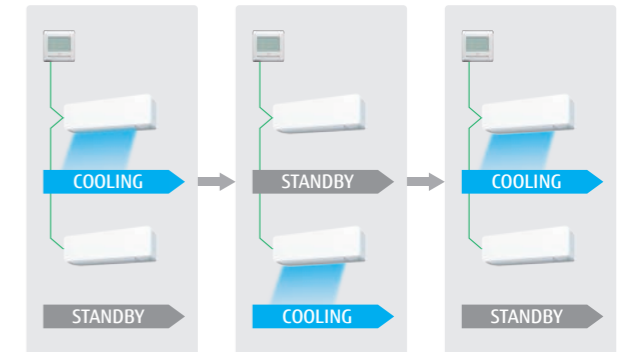

2) Back up operation

In case of unexpected Indoor unit error, other Indoor units will start providing back up operation.

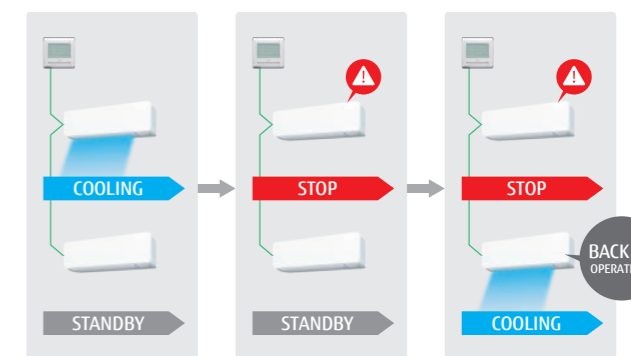

3) Lag Operation

In case of unexpected room temperature rise, other Indoor Units will start providing lag operation.

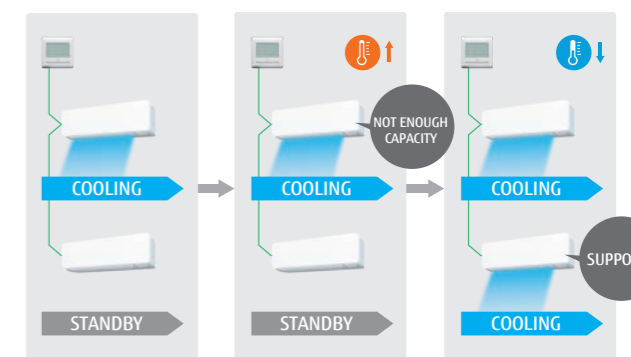

*1: "Lead Lag Setting" is an easy-to-use function for room temperature control when using multiple indoor units, while reducing the burden placed on each indoor unit.

If you wish to make use of this function, ensure you use indoor units equipped with a "Special Cooling" function.

For Split products with "Special Cooling" function, refer to S-068 to S-071.

If you use indoor units that do not have a "Special Cooling" function, under certain conditions, there is a chance that "Backup operation" may not operate correctly, and the "Lead Lag Setting" function will not give the expected results.

Additionally, for rooms that require strict conditions, such as server rooms, please consider other appropriate measures.

Please note that we will not provide compensation for any damages suffered to your appliances or data as a result of using this function. For more details, please confirm with your nearest retail store.

Specifications

Model name	UTY-RNRGZ5
Power Source	DC 12 V
Dimensions (H × W × D) (mm)	120 × 120 × 20.4
Weight (g)	220

DC 12 V is supplied by the indoor unit.

Wired remote controller

UTY-RLRG



- ON/OFF/Weekly timer settings
- A built-in thermo sensor monitors and controls room temperature accurately.
- When something goes wrong, an error code is displayed.
- 16 error codes from the most recent one will be kept in the history. (Last 16 error codes can be accessed)
- Nonpolar 2-core type

Up to
16 indoor units
Up to
1 group

High performance and compact size

A single remote controller controls each connected indoor unit and provides a weekly timer function and a variety of energy-saving options.



Visually intuitive operation

- The operation mode, set temperature, and fan speed are shown prominently on the top screen.
- Each function to be set is indicated by an icon.
- The control guide makes it simple and straightforward to operate a remote controller.

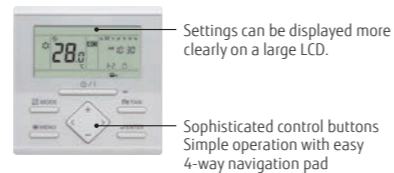

Compact wired remote controller

UTY-RCRGZ1



- Simple design that matches stylish interiors
- The body of the controller, which is easy to install, is designed to conform to the European standard junction box.
- Can be operated both by wireless and wired remote controller.
- Nonpolar 2-core type

Up to
1 indoor units
Up to
1 group

Large screen and simple display

- Large screen but compact size
- Large, easy-to-read letters are used.
- The controls are simple and easy to understand.

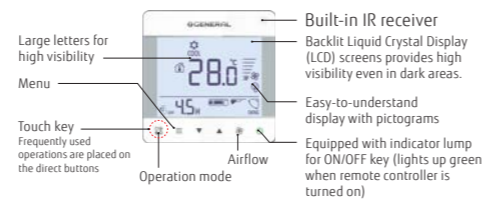

System overview

VRF connection

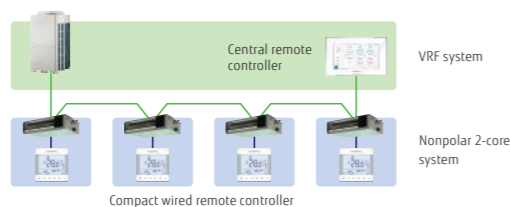

RAC connection

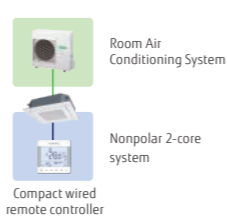

Specifications

Model name	UTY-RLRG	UTY-RCRGZ1
Power source	12 V DC	12 V DC
Dimensions (H × W × D) (mm)	120 × 120 × 17	86 × 86 × 44
Weight (g)	170	135

12 V DC supplied by an indoor unit

Wired remote controller

UTY-RVNGM



Up to
16 indoor units
Up to
1 group

Hi-grade individual control with a wide range of functions.

- 3.7-inch backlit LCD screen.
- Supports energy-saving functions with simple operation.
- Supports 9 languages: English, French, German, Greek, Italian, Portuguese, Russian, Spanish, and Turkish

Visually intuitive operation

- Each function is displayed as an icon.
- Main functions are indicated by large icons: "Mode," "Set Temp," and "Fan"
- Easy operation with control guide display
- Simple operation with easy 4-way navigation pad

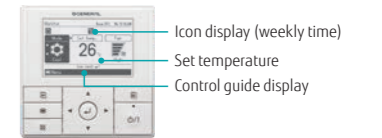

High performance and compact size

- A single remote controller controls each connected indoor unit and provides a variety of energy-saving options.



Wired remote controller

UTY-RNNGM



Up to
16 indoor units
Up to
1 group

- Simple operation with Built-in Weekly/Daily Timer.
- Control up to 16 indoor units.
- Up to 2 Wired remote controllers can be connected to a single indoor unit.

Accurate control for comfort

A thermo sensor built into the remote controller monitors room temperature accurately. The wired remote controller and an optional Remote sensor can be installed in any location to meet any requirement.

Examples of sensor changes

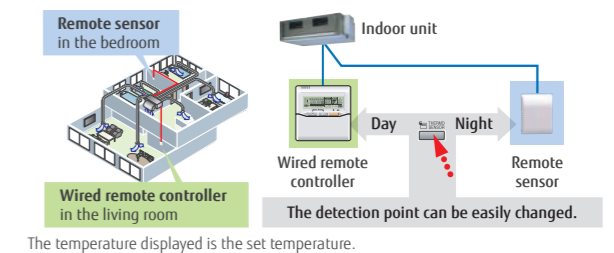

The temperature displayed is the set temperature.

Built-in timer

Weekly timer: ON/OFF time can be set to operate twice for each day of the week.
Temperature setback timer: Sets the time to change the temperature setting and the time to hold the setting for each day of the week.
 At "Weekly timer" + "Temperature setback timer" setup

Specifications

Model name	UTY-RVNGM	UTY-RNNGM
Power source	12 V DC	12 V DC
Dimensions (H × W × D) (mm)	120 × 120 × 21.3	120 × 120 × 18
Weight (g)	220	160

12 V DC supplied by an indoor unit

Simple remote controller

UTY-RSRG / UTY-RHRG (without operation mode)

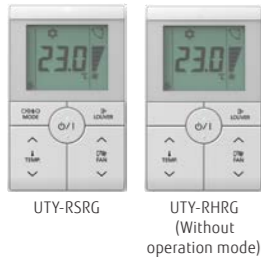

Compact remote controller with basic functionality

- Up to 16 indoor units can be controlled with one remote controller.
- Suitable for hotels or offices as it is easily operated with no complex functions.
- Simple design that matches stylish interiors
- Large LCD screen and easy-to-use control buttons
- Backlight: White backlight makes it easy to operate in the dark.
- Nonpolar 2-core type

Up to
16 indoor units
Up to
1 group

Supports a variety of applications

- **Vertical louver control:** Adjusts the vertical airflow direction of a duct-type indoor unit with an auto louver or a cassette type installed in a hotel room or a conference room.



- **Setting temperature range limitation:** Enables an indoor unit to operate in an energy-saving manner in a small building not equipped with a central remote controller.

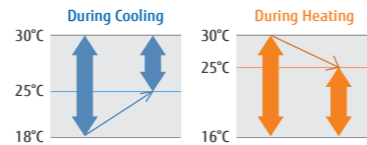

- **Built-in room temperature sensor:** Monitors and controls room temperature accuracy.

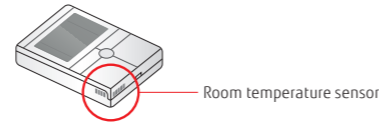

Wireless remote controller

UTY-LNTG



Simple and versatile operations with a choice of 4 different types of timers

- Controls up to 16 indoor units.

Built-in timer

4 timer programs: ON/OFF/Program/Sleep
Program timer: Sets ON/OFF time once for every 24 hours.
Sleep timer: Adjusts the set temperature automatically while the sleep timer is on.

Easy installation and operation

Different codes can be assigned to up to 4 indoor units to prevent a mix-up.
Wide and precise transmitting range

Up to
16 indoor units
Up to
1 group
Up to
4 different daily timers

Specifications

Model name	UTY-RSRG	UTY-RHRG	UTY-LNTG
Power source	12 V DC	12 V DC	3.0V (1.5V R03/LR03/AAA x 2)
Dimensions (H × W × D) (mm)	120 × 75 × 19.4	120 × 75 × 19.4	205 × 61 × 17
Weight (g)	120	120	125

12 V DC supplied by an indoor unit

Wireless remote controller

UTY-LNVG



NEW



Up to
16 indoor units
Up to
1 group
Up to
4 different daily timers

New stylish design with backlight

- It has adopted a new simple and stylish design.
- The built-in backlight allows the screen to be seen even in dark rooms.

Built-in timer

4 timer programs: ON/OFF/Program/Sleep
Program timer: Sets ON/OFF time once for every 24 hours.
Sleep timer: Adjusts the set temperature automatically while the sleep timer is on.

Error diagnosis

It can detect the reason for system errors easily.
When an error is detected, the error code number can be checked using the remote controller display.

Precise control

The setting temperature can be adjusted precisely depending on the environment as the controller can set the temperature via 0.5 °C*.

*Depends on the indoor unit

Wireless remote controller

UTY-LNHG



Up to
16 indoor units
Up to
1 group
Up to
4 different daily timers

Simple and versatile operations with a choice of 4 different types of timers

- Controls up to 16 indoor units.

Built-in timer

4 timer programs: ON/OFF/Program/Sleep
Program timer: Sets ON/OFF time once for every 24 hours.
Sleep timer: Adjusts the set temperature automatically while the sleep timer is on.

Easy installation and operation

Different codes can be assigned to up to 4 indoor units to prevent a mix-up.
Wide and precise transmitting range

Specifications

Model name	UTY-LNVG	UTY-LNHG
Battery	3.0V (1.5V R03/LR03/AAA x 2)	3.0V (1.5V R03/LR03/AAA x 2)
Dimensions (H × W × D) (mm)	181 × 58 × 17	170 × 56 × 19
Weight (g)	116	85

12 V DC supplied by an indoor unit

IR receiver unit for duct type

UTY-LRHGM / UTY-LBTGM

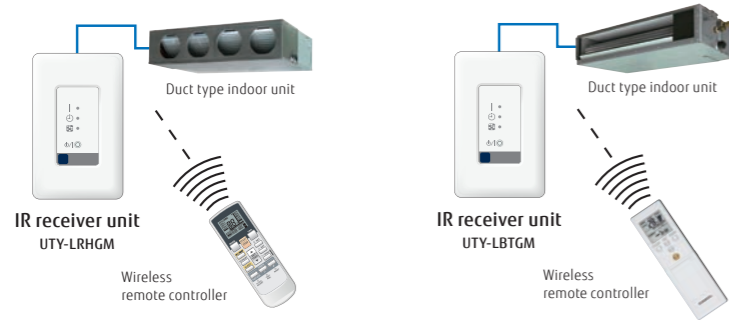

The wireless remote controller controls duct type indoor units.

IR receiver unit for Cassette

UTY-LBTGC



Cassette type indoor unit can be controlled with a Wireless remote controller.

IR receiver unit for ceiling type

UTY-LBTGH



The wireless remote controller controls ceiling type indoor units.

Specifications

< Wireless Remote Controller >

Model name	UTY-LRHGM	UTY-LBTGM	UTY-LBTGC	UTY-LBTGH
Battery	1.5 V (R03/LR03/AAA)	1.5 V (R03/LR03/AAA)	1.5 V (R03/LR03/AAA)	1.5 V (R03/LR03/AAA)
Dimensions (H × W × D) (mm)	170 × 56 × 19	205 × 61 × 17	205 × 61 × 17	205 × 61 × 17
Weight (g)	85	125	125	125

< IR Receiver Unit >

Battery	DC5V	DC5V	DC5V	DC5V
Dimensions (H × W × D) (mm)	145 × 90 × 30	145 × 90 × 30	-*	-*
Weight (g)	150	150	140	100

DC 5 V is supplied the indoor unit.
*It will replace the parts of the indoor unit to be connected.

IR receiver unit for duct type

UTB-YWC / UTY-TRHX



The wireless remote controller controls duct type* indoor units.

*Large airflow duct types do not work with this IR receiver unit.



*A separate wireless remote control (model: UTY-LNHG) is required.

IR receiver unit for Cassette

UTY-LBHXD / UTY-TRHX



Cassette type indoor unit can be controlled with a Wireless remote controller.

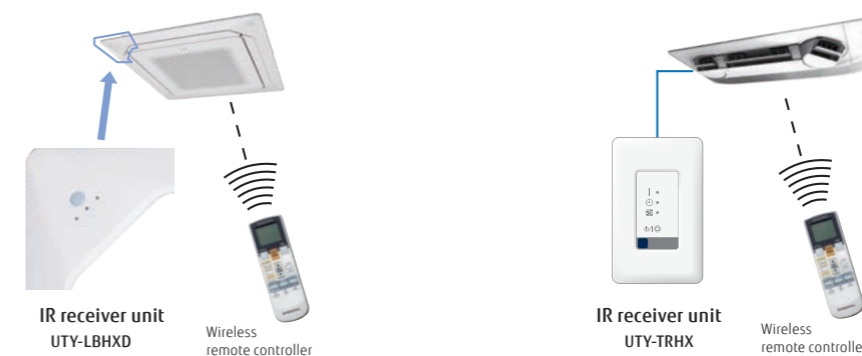

*A separate wireless remote control (model: UTY-LNNG or UTY-LNHG) is required.

Specifications

< Wireless Remote Controller >

Model name	UTB-YWC	UTY-LBHXD	UTY-TRHX
Battery	1.5 V (R03/LR03/AAA)	1.5 V (R03/LR03/AAA)	1.5 V (R03/LR03/AAA)
Dimensions (H × W × D) (mm)	170 × 56 × 19	170 × 56 × 19	170 × 56 × 19
Weight (g)	85	85	85

< IR Receiver Unit >

Battery	DC5V	DC5V	DC5V
Dimensions (H × W × D) (mm)	145 × 90 × 30	-*	145 × 90 × 30
Weight (g)	150	140	150

DC 5 V is supplied the indoor unit.
*It will replace the parts of the indoor unit to be connected.

WLAN adapter

UTY-TFSXH3 / UTY-TFSXJ3



USB type for single split models
UTY-TFSXH3



UTY-TFSXJ3
(CN connector type)

Up to
1 indoor units



AIRSTAGE Mobile

“AIRSTAGE Mobile” is an application software that enables you to manage the Fujitsu General's air conditioner(s) with a mobile device from anywhere.

- Maximum 5 accounts per 1 indoor unit
- Room / Outdoor temperature display
- Can be used for a Single / Multi and VRF indoor units.
- No separate external power supply required
- “AIRSTAGE Mobile” is an application software that enables you to operate the Fujitsu General's air conditioners with a mobile device.



User Friendly for Everyone

Enjoy easy-to-use centralized operation of air conditioners via a smartphone anytime, anywhere



Image*

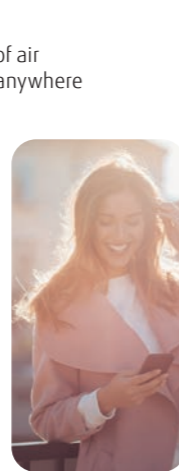

House Owner



Shop Owner



Commercial Building Owner

Main Functions

- ON / OFF
- Operation mode
- Fan speed
- Louver position
- Set temperature control
- Weekly timer
- Room temperature display
- Outdoor temperature display
- Error display

*Contents of display differ depending on the type of indoor unit.

New Design!

Ease of use is pursued to achieve a stylish design.

The more legible and accessible timer UI enables effortless schedule management.

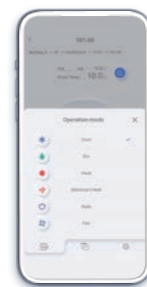

Mode change



Fan speed change



Weekly timer

Features: AIRSTAGE Mobile

Centralized operation for flexible remote management of all air conditioners

AIRSTAGE Mobile is ideal for a wide range of applications, from large residential buildings to smaller commercial spaces such as offices and stores. Anyone who has a smartphone and an adapter can easily manage the system at a low cost.

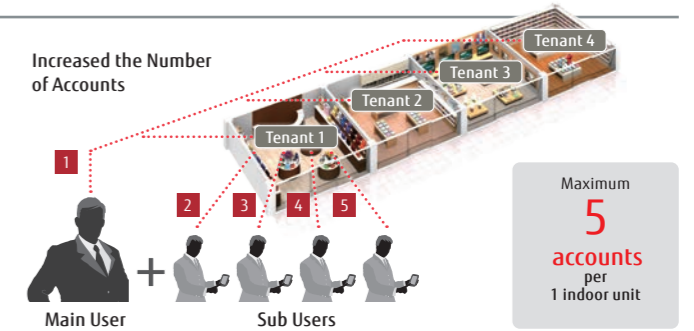

Hierarchical group management

Multiple air conditioners can be combined into a single group for centralized operation. Several groups can also be organized at once. Grouping the air conditioners by building, floor, or room makes it easy for users to monitor their operation status and operate them quickly.

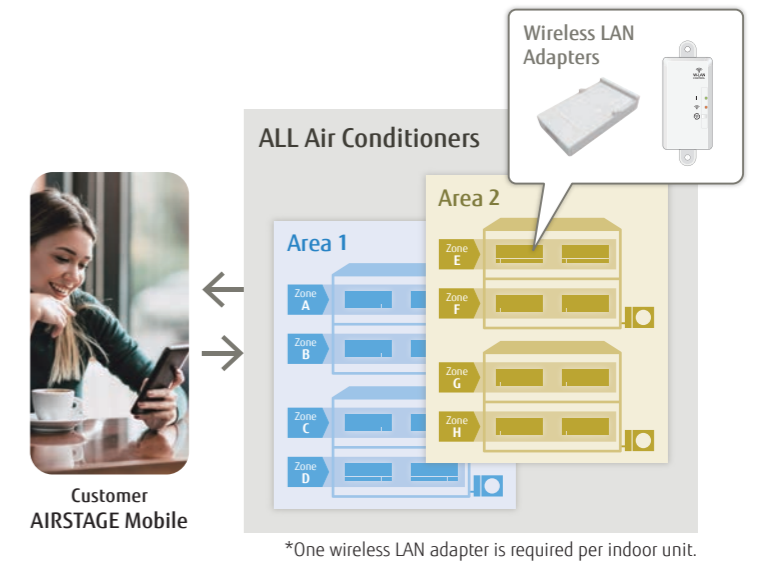
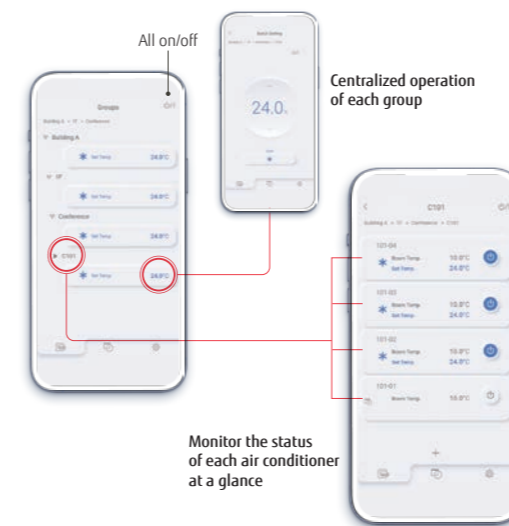

*One wireless LAN adapter is required per indoor unit.

Operate air conditioner and check its operation status just by talking to it

Connecting with a smart speaker allows the user to operate the air conditioner and check its operation status just by talking to it.

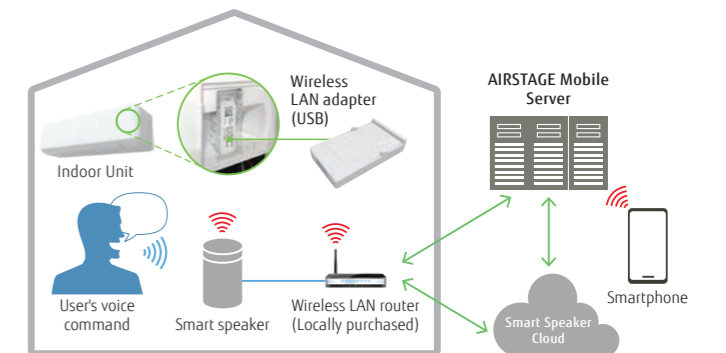

* The new WLAN adapters for AIRSTAGE Mobile are upper compatible for the indoor units that can connect the following WLAN adapters for FGLair.

	CN connector type	USB type
for FGLair	UTY-TFSXZ1	UTY-TFSXF2
for AIRSTAGE Mobile	UTY-TFSXJ3	UTY-TFSXH3

Specifications

Model name	UTY-TFSXJ3(CN connector type)	UTY-TFSXH3
Dimensions (H × W × D) (mm)	71 × 38 × 15	56.7 × 34 × 9.72
Weight (g)	35	30

WLAN adapter

UTY-TFNXZ1 / UTY-TFSXZ1 / UTY-TFSXF2



USB type for single-split models
UTY-TFSXF2



UTY-TFNXZ1
(3-wire RC-line type)
UTY-TFSXZ1
(CN connector type)

Up to
1 indoor units



- This interface provides the most advanced solution for the remote management of an air conditioning system by using smartphones, tablets, and computers.
- No separate external power supply required
- Can be used for a Single / Multi and VRF indoor units.

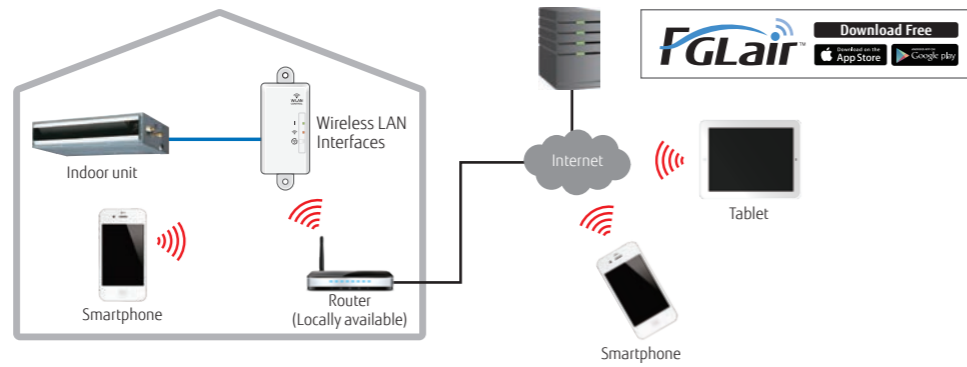

Basic control

- Turning the units on and off
- Mode control (Heat, Cool, Dry, Auto, Fan)
- Fan speed control
- Louver position (airflow direction setting)
- Timer operation setting (Weekly timer)
- Economy mode setting

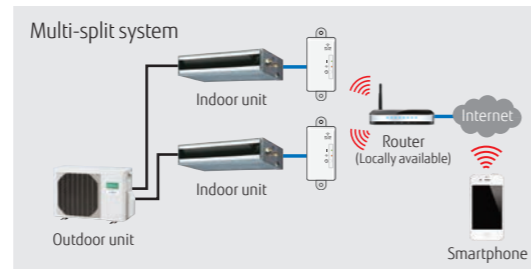

Multiple air conditioning management

- Manage multiple air conditioning systems in different locations.

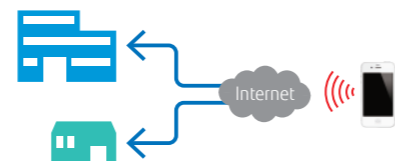

Error alert and e-mail notice

- E-mail notification alerts
- Air conditioning malfunction alert
- Enables quick service response when errors occur.

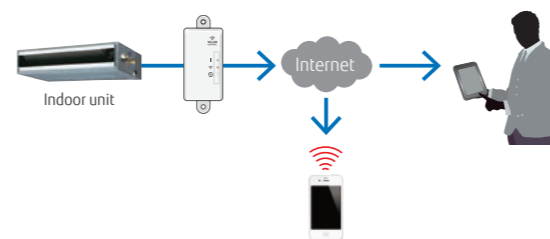

WLAN adapter (USB type) UTY-TFSXF2

A compact USB type is available. No need for specialized installation. Easily installed on the indoor unit.



Specifications

Model name	UTY-TFNXZ1 (3-wire RC-line type)	UTY-TFSXZ1 (CN connector type)	UTY-TFSXF2
Dimensions (H × W × D) (mm)	71 × 38 × 15	71 × 38 × 15	56.7 × 34 × 9.72
Weight (g)	35	35	30

WLAN adapter

FG-RC-WIF1Z2 / FG-IR-WIF1Z1 / FG-AC-WIF1Z1



FG-RC-WIF1Z2
(3-wire RC-line type)



FG-AC-WIF1Z1
(CN connector type)



FG-IR-WIF1Z1
(IR type)

Up to
1 indoor units

AC Cloud Control

- This interface provides the most advanced solution for the remote management of an air conditioning system by using smartphones, tablets, and computers.
- No separate external power supply required

Installation example

[3-wire RC-line type/CN connector type]

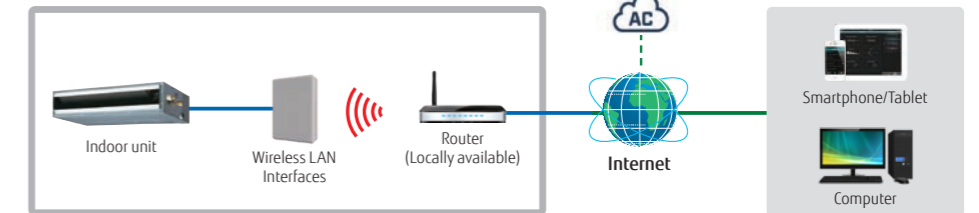

[IR type] Connection to wall-mounted type

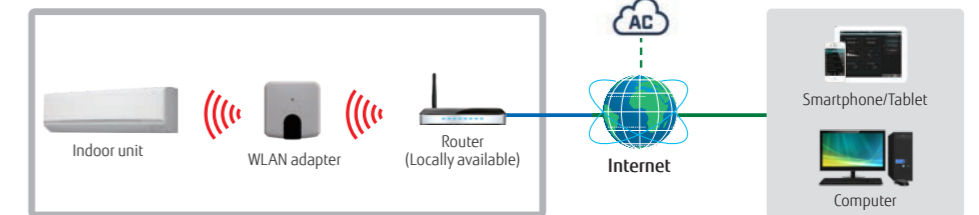

[IR type] Connects to the product with the optional receiver kit

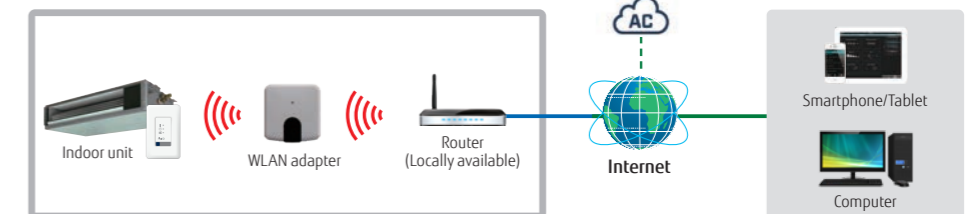

*IR receiver required.

Basic control

- Turning air conditioner on and off
- Mode select (Heat, Cool, Dry, Auto, Fan)
- Louver position (airflow direction setting)
- Fan speed control
- Room temperature display
- Setting temperature
- Multiple language support
- One single scene is created.

Advanced control (optional functions)

- Climate-based operation modes (ECO, Comfort, and Powerful) (to be available in the future)
- Schedule functions (ON/OFF, modes, set temperature, fan speed, louver position)
- Setting temperature range limitation
- Multiple Scenes and Calendars are created.
- Smart Speaker compatibility
- Advanced internet service connections

Notification and operation history

- E-mail notification alerts
- Air conditioning malfunction alert
- Connectivity monitoring and alert
- Operation history (to be available in the future)

Specifications

Model name	FG-RC-WIF1Z2 (3-wire RC-line type)	FG-AC-WIF1Z1 (CN connector type)	FG-IR-WIF1Z1 (IR type)
Number of controllable groups	1	1	1
Dimensions (H × W × D) (mm)	108 × 70 × 28	81 × 78 × 28	127 × 50 × 17
Weight (g)	80	76	80

Multiple protocol WLAN adapter

FG-RC-WMP1Z1 / FG-IR-WMP1Z1 / FG-AC-WMP1Z1



Intesis
BY HBS NETWORKS



FG-RC-WMP1Z1
(3-wire RC-line type)

Intesis
BY HBS NETWORKS



FG-AC-WMP1Z1
(CN connector type)

Intesis
BY HBS NETWORKS



FG-IR-WMP1Z1
(IR type)

Up to
1 indoor units

Specifications

Model name	FG-RC-WMP1Z1 (3-wire RC-line type)	FG-AC-WMP1Z1 (CN connector type)	FG-IR-WMP1Z1 (IR type)
Number of controllable groups	1	1	1
Dimensions (H × W × D) (mm)	70 × 100 × 28	127 × 50 × 17	81 × 78 × 28
Weight (g)	98	80	76

Multiple protocol LAN adapter

FG-TL-MBS16Z1



Intesis
BY HBS NETWORKS



FG-TL-MBS16Z1
(VRF type)

Up to
16 indoor units

Specifications

Model name	FG-TL-MBS16Z1 (VRF type)
Power supply	9 to 36 V DC, Max.: 140 mA or 24 V AC 50/60 Hz, Max.: 127 mA.*
Input power (W)	1.7
Dimensions (H × W × D) (mm)	90 × 88 × 56
Weight (g)	330

*24 V DC power supply is recommended.

AC Cloud Control

- Air conditioner control of Home Automation systems via wireless LAN connection.
- No separate external power supply required

Installation example

[3-wire RC-line type/CN connector type]

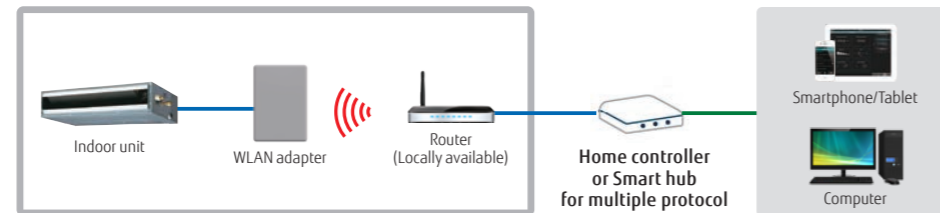

[IR type]

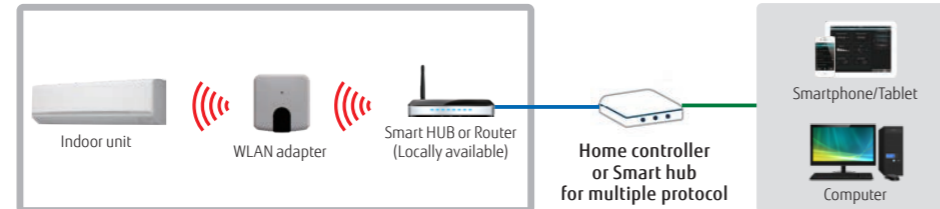

*IR receiver required for other than wall-mounted type.

Home central remote controller

UTY-DMMGM / UTY-DMMGM1



Up to
1 multi-split system
Up to
6 indoor units

For 5-unit and 6-unit multi-split type

- Batched control of up to 6 indoor units For all indoor units connected to the remote controllers, the Home central remote controller sets room temperature, airflow volume, and remote controller prohibition from other remote controllers at once.
- Supports 9 languages: English, French, German, Greek, Italian, Portuguese, Russian, Spanish, and Turkish.
- Large backlit LED screen
- Large, easy-to-see operation panel

Example of system configuration

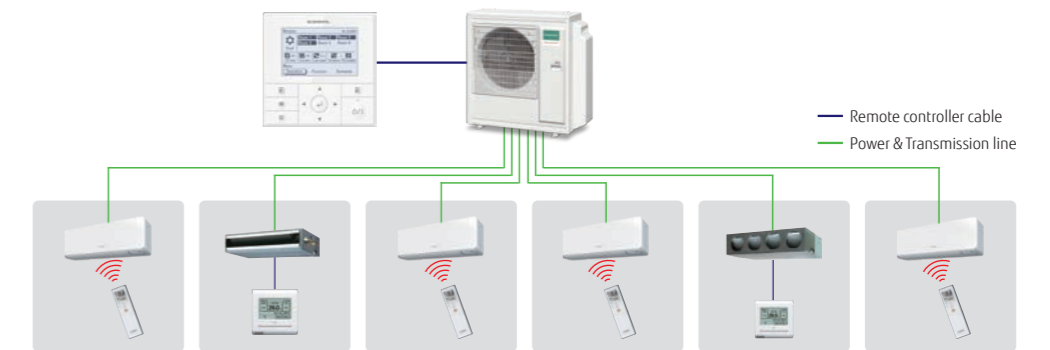

Home central remote controller

Weekly timer

Up to 4 ON/OFF settings can be programmed per day. Two weekly patterns can be set, one for the cooling season and the other for the heating season.

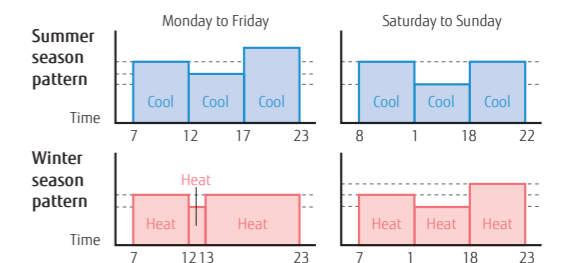

Low noise operation

You can choose from 4 low noise levels depending on the installation environment. ON/OFF timing of low noise mode can be set with the timer.

10°C heat operation

When you leave the house, the air conditioner runs a minimum heating operation to maintain the room temperature at 10°C.

*Consult your dealer for conditions of use.

Economy operation

When you select energy-saving economy mode, the temperature setting for the indoor unit increases (during cooling operation) or decreases (during heating operation) by 1°C and the maximum electric value of the outdoor unit is suppressed.

Prohibiting local control, including settings such as child lock

The Home central remote controller is equipped with a lock function to prevent unauthorized operation from the remote controllers of the indoor unit in each room. The Home central remote controller is equipped with a child lock to prevent children from accidentally turning the air conditioner on or off or changing its settings.

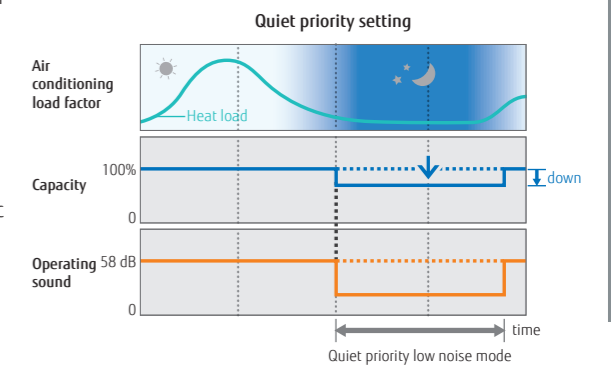

Specifications

Model name	UTY-DMMGM/UTY-DMMGM1
Power source	12 V DC
Dimensions (H × W × D) (mm)	120 × 120 × 21.3
Weight (g)	220

12 V DC supplied by an indoor unit

Central remote controller

UTY-DCGGZ3



NEW



Up to **100** indoor units
Up to **50** groups

For tenants in small to midsize commercial premises

- Individual control and monitoring of up to 100 indoor units
- 7.0inch TFT color screen
- Visually intuitive operation
- Room temperature display by indoor unit sensor & remote controller sensor
- 50 Remote Controller Groups Display & remote controller group rename
- Supports 14 languages: Chinese (Simplified/Traditional), Dutch, English, French, German, Greek, Italian, Polish, Portuguese, Russian, Spanish, Turkish, and Thai (Remote Management only)

Easy operation

Air conditioning management by detecting room temperatures of each room

The room temperature detected with indoor unit sensor or remote controller sensor can be displayed. New model can detect the room temperature by indoor units sensors even if wired remote controllers are not connected to the indoor units.

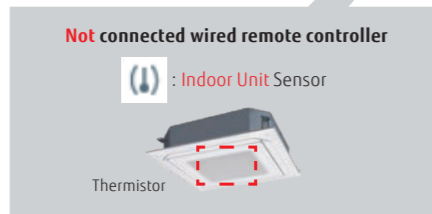

*Room temperature is displayed only when indoor unit operates.

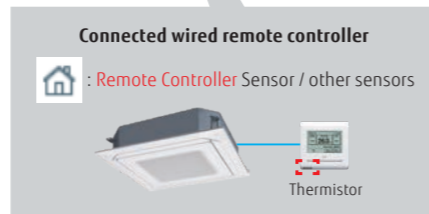

50 Remote Controller Groups Display

The group display and the 50 remote controller groups display can be switched easily. Users can choose which display is better, depending on the situation.

Group Display



Manage & Monitor by each Groups

50 Remote Controller Groups Display

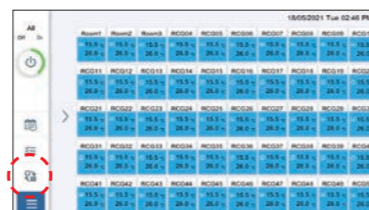

Manage & Monitor by 50 Remote Controller Groups



Remote Controller Groups Rename

The remote controller group names can be changed. Users can know easily where the air conditioning is located by changing the remote controller group names.



The remote controller group name can be changed.

Features: Central Remote Controller

- Easy intuitive operation from the touch panel display.
- All functions can be accessed through the monitoring screen showing a pop-up window for detailed operation.

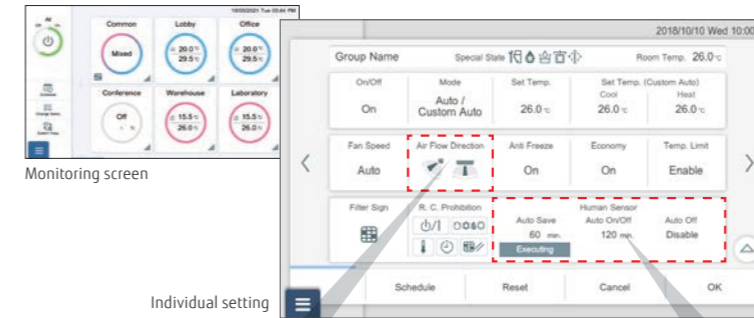

Added individual wind direction control

Individual wind direction control has been added.
Circular Flow cassette / 3D Flow cassette



Circular flow cassette

Human sensor Compatible

Human sensor setting
• Auto save
• Auto on / off
• Auto off detection time
• Enable and disable

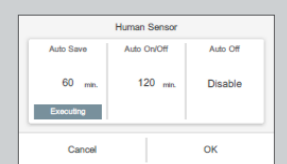

Remote Management

Remote monitoring / Remote operation

New central remote controller can control your tenant's air conditioner anytime and anywhere.

When the central remote controller manages the indoor units of some tenants, air conditioning of each tenant can be managed separately online.

Increased the Number of Accounts

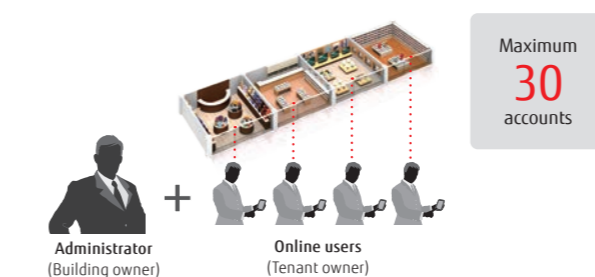

Maximum **30** accounts

Trouble support function

Display error details

Display descriptive explanation when an error occurs



Sensor value monitoring function

Monitor sensor data of indoor unit / outdoor unit, send mail

Notify room temperature by email*

Notify by e-mail when the temperature around the air conditioner is too high or too low

*:This function is available only when using wired remote controller.

Schedule management

Annual schedule

- An annual schedule can be arranged for each remote controller group or user-defined group.
- Allows for the programming of special settings for weekends, holidays, and store closings throughout the year.

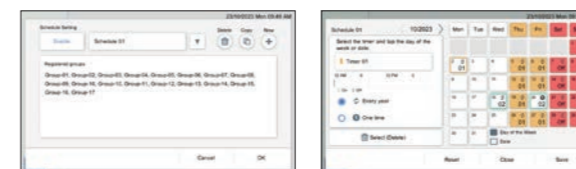

low noise schedule

Low noise operation of outdoor units can be scheduled.



Automatic return to set temperature

A function that automatically returns the changed temperature to its original value over time.

Specifications

Model name	UTY-DCGGZ3
Power Supply	100-240 V 50/60 Hz
Dimensions (H × W × D) (mm)	134.6 × 216.2 × 37.9
Weight (g)	800

Touch panel controller

UTY-DTGGZ1



- Large 7.5-inch TFT color LCD screen
- Touch screen operation
- Stylish design to fit nicely into any room environment
- Controls up to 400 indoor units.
- Icon or list view can be selected in monitoring mode.
- Supports 7 languages: Chinese, English, French, German, Polish, Russian, and Spanish.
- Mounted with LAN adapter for remote control & operation, external input/output with emergency stop and batch ON/OFF

Up to
400 indoor units
Up to
100 outdoor units
Up to
400 groups

Easy operation

- Wide range of simple-to-understand icons
- Operate by pressing the icons on the screen with your finger or a stylus.
- The color on the back identifies the current control operation; blue is for monitoring and green is for operational control.

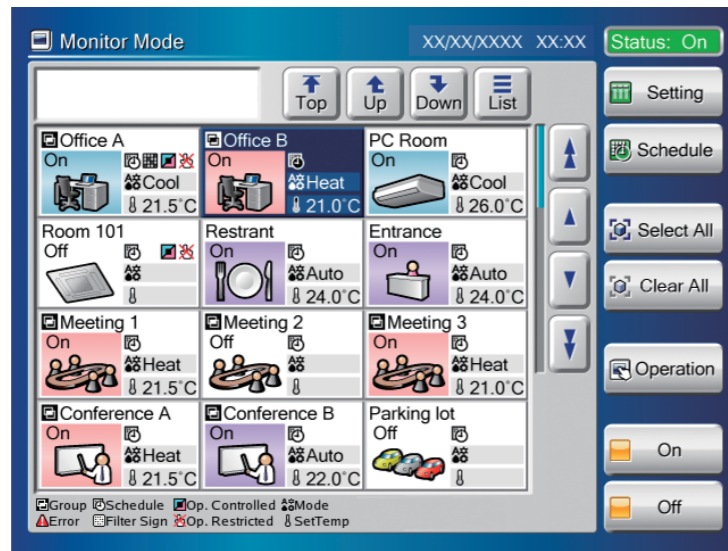

Easy maintenance

- The flat touch panel can be easily cleaned.
- Touch panel controller with non-glare coating to prevent finger marks
- Front cover for easy removal.



Easy installation

- The touch panel controller can be mounted on a wall.
- Flat back surface enables easy installation anywhere on a wall.
- No additional parts or components required for installation



Controls up to 400 indoor units.

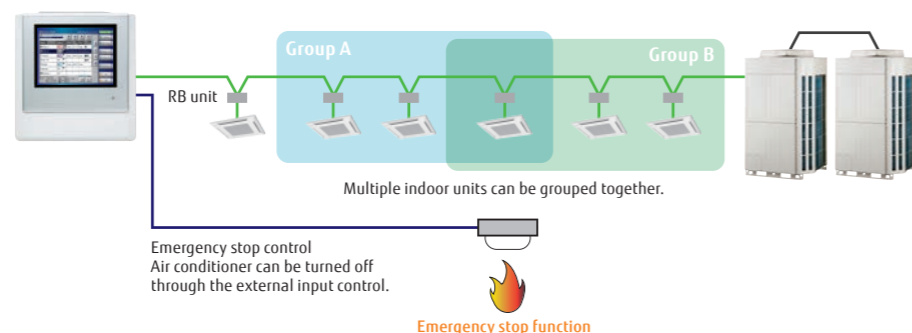

Features:

Control & monitoring

- Control and monitor Fujitsu General air conditioners via LAN or internet.
- Users and tenants can manage their assigned equipment from anywhere by computer or tablet.
- When something goes wrong, an error notice is sent by e-mail for prompt troubleshooting.

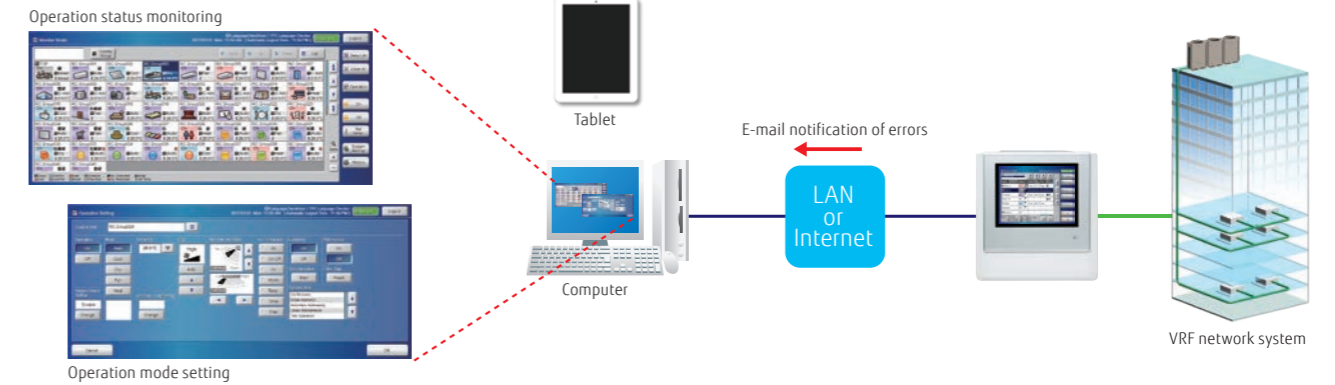

Smartphone

Model name	Browser
Nexus 6P (Android 7.1.1)	Google Chrome 5.5
iPhone 7 (iOS 10.1)	Safari 10

Tablet

Model name	Browser
iPad Pro 9.7 inch (iOS 10.2.1)	Safari 10

Flexible access permissions can be granted to users at each point level.

The administrator can register multiple users and permit them to access any indoor unit and any functions.

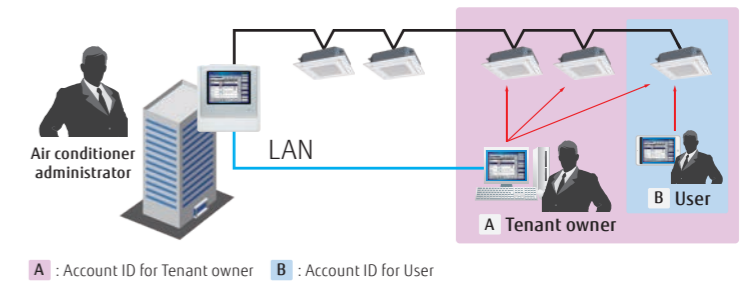

A : Account ID for Tenant owner B : Account ID for User

Additional languages

Supports 7 languages as standard: Chinese, English, French, German, Polish, Russian, and Spanish. Create a language database to integrate additional languages into the remote device. The added languages will only be displayed on the remote device and cannot be added to the Touch panel controller.

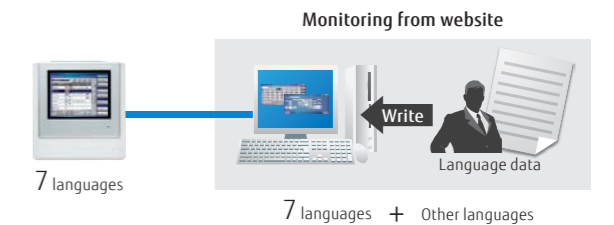

Electricity charge apportionment (Option: UTY-PTGXA)

- Energy cost can be calculated and allocated to each billing user in proportion to the amount of energy used for air conditioning.

- Apportionment charge/bill calculation
- Tenant (block) setting
- Common facilities apportionment setting
- Rated power consumption allotment
- Individual calculations for cooling and heating
- Electricity meter supported

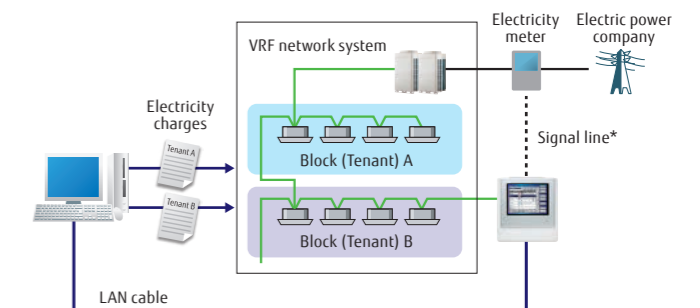

* An electricity usage meter can be connected to an external input connector of the Touch panel controller. In that case, the meter cannot be connected to an outdoor unit at the same time.

Features:

Automatic setting for daylight saving time

Functions provided

- 1) Schedule setting for daylight saving time
 - It prevents the user from forgetting to set daylight saving time. In addition, it saves time and effort for the user.

Automatic clock adjustment

- 2) Time can be set for all controllers in a batch automatically.

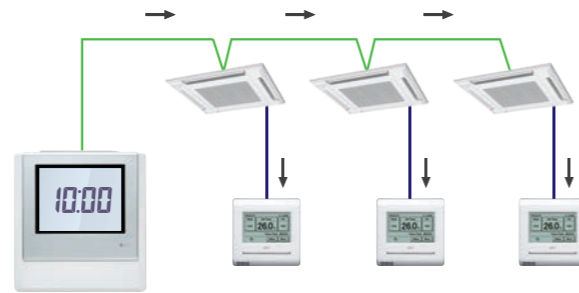

Outdoor unit low noise operation

You can choose from 4 low noise levels depending on the installation environment. ON/OFF timing of low noise mode can be set with the timer.

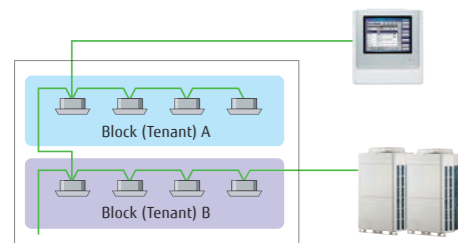

Quiet priority setting

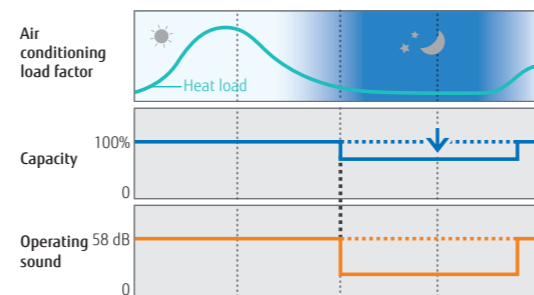

Energy-saving controls

Custom Auto

- Maintains 2 separate setpoints for heating and cooling operations.
- Automatically switches between heating and cooling modes.

* Not available for some models



Cooling set temp. 28°C, Heating set temp. 18°C

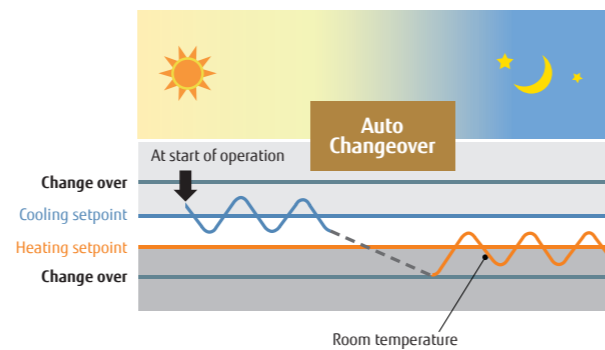

Refrigerant leak detector

Refrigerant leakage status is indicated by the management equipment. A pop-up message is displayed to notify the user, and the refrigerant is shut off.



FUNCTIONS SUMMARY

	UTY-DTGGZ1	Monitoring side
Air conditioning control functions		
ON/OFF	●	●
Operation mode setting*	●	●
Fan speed control	●	●
Room temperature setting	●	●
Setting temperature range limitation	●	●
Test operation	●	●
Vertical louver setting	●	●
Horizontal louver setting	●	●
Individual louver control	●*1	●
Group setting	●	●
Remote controller prohibition	●	●
Anti-freeze setting	●	●
Set temperature auto return	—	●
Energy-saving controls	—	●
Economy mode setting	●	●
Human sensor control	—	●
Displayed items		
Error	●	●
Defrosting	●	●
Current time	●	●
Day of week	●	●
Remote controller prohibition	●	●
Cooling/heating priority	●	●
Address display	●	●
Room temperature	●*3	●*3
Multiple language support	●	●
Setting for daylight saving time	●	●
Time zone setting	●	●
Name registration	●	●
Backlighting	●	●
Language setting	7	7+ other
Filter sign reset	●	●
Memory operations	●	●
Refrigerant leak detector	●	●

●: Supported ○: Optional function —: Not supported

*1 Only setting cancellation can be operated.

*2 Only available for external input control.

*3 Available only when using a Wired remote controller.

	UTY-DTGGZ1	Monitoring side
Timer		
	Period	Year
Schedule timer	ON/OFF, Temp, Mode, Times per day	20
		Year
ON/OFF timer	—	—
Sleep timer	—	—
Program timer	—	—
Auto-off timer	—	●
Day off	●	●
Minimum unit of timer setting (minutes)	10	10
Control		
Remote monitoring management system	●	●
Electricity charge apportionment	○	○
Error history	●	●
Emergency stop	●*2	●*2
Remote monitoring management	—	●
Energy-saving management	—	—
E-mail notification in case of failure	—	●
Key lock	● Password setting	—
Low noise mode	●	●

Specifications

	UTY-DTGGZ1
Model name	UTY-DTGGZ1
Power supply	Single phase ~100 to 240 V 50/60 Hz
Dimensions (H × W × D) (mm)	260 × 246 × 54
Weight (g)	2,150
Interfaces	Transmission/LAN/USB/EXT IN/EXT OUT/Reset SW

System controller

UTY-APGXZ1 **Software**

Up to
4 VRF network systems
Up to
400 outdoor units
Up to
1,600 indoor units

System controller enables advanced integrated monitoring and control of VRF network systems operating in small to large buildings.

- Up to 1,600 indoor units and 400 outdoor units on up to 4 VRF network systems can be controlled.
- To accommodate facility management needs, the system controller offers—in addition to precise air conditioning control—remote central control, electricity charge apportionment, schedule management, and energy-saving options for VRF network systems.
- Supports 7 languages: Chinese, English, French, German, Polish, Russian, and Spanish.



System controller lite

UTY-ALGXZ1 **Software**

Up to
1 VRF network systems
Up to
100 outdoor units
Up to
400 indoor units

System controller Lite offers a set of standard functions to manage air conditioners operating in a small or midsize building.

- Up to 400 indoor units and 100 outdoor units on a VRF network system can be controlled.
- In addition to precise air conditioning control, a variety of applications are available as options to offer a wider range of control.
- Supports 7 languages: Chinese, English, French, German, Polish, Russian, and Spanish.



Visually intuitive operation

Click & Operate: The visual representation of the property is shown on the screen from the perspective most suitable for operation (Click & Operate) You can select from among 4 display options: site, building, floor, and list.

Freely define groups for batched control: Indoor units can be grouped for simplified batch control from the tree menu. They can be grouped by organizational hierarchy, such as by division, department, and section.

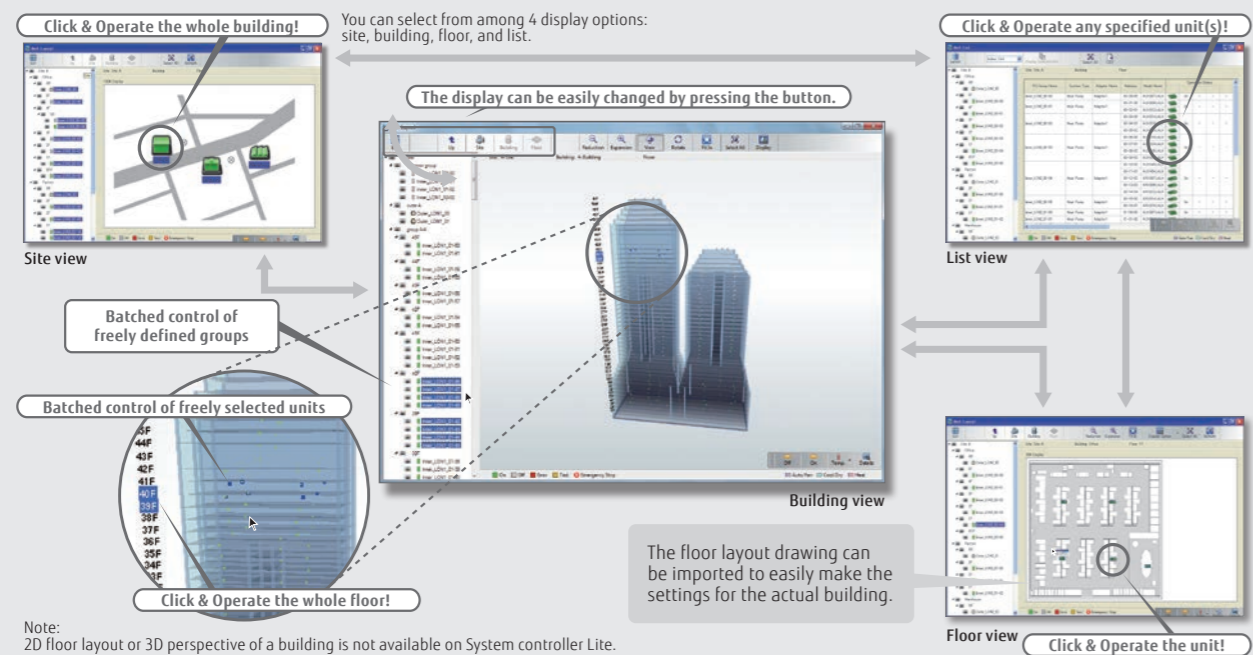

Note: 2D floor layout or 3D perspective of a building is not available on System controller Lite.

Features:

Third-party devices connected via MODBUS® can be controlled.

Standard for System Controller **Option** for System controller Lite UTY-PLGXX2

When a MODBUS® adapter (locally available) is connected to a computer, electrical equipment and devices supported by MODBUS® can be monitored and controlled centrally from the computer. The central control can reduce wasted energy throughout an entire building resulting from a failure to turn equipment off during or after work, as well as reduce the need for on-site patrols.

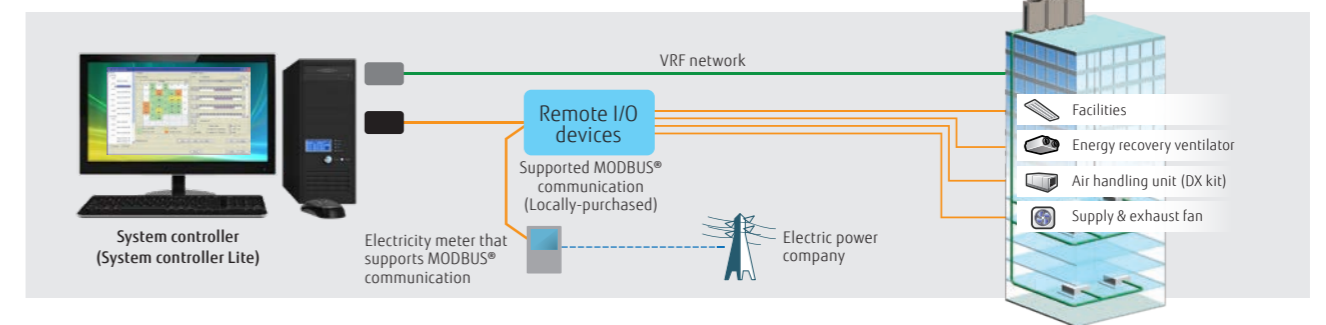

Wide-ranging operation and data management

Standard System controller and System controller Lite

Schedule management

- An annual schedule can be arranged for each remote controller group or user-defined group.
- ON/OFF, operation mode, remote controller prohibition, and temperature settings can be programmed for up to 143 times per day at 10-minute intervals and for up to 101 configurations for each remote controller group.
- Settings can be programmed for a period that spans midnight.
- Allows for the programming of special settings for weekends, holidays, and store closings throughout the year.
- Low noise operation of outdoor units can be scheduled.

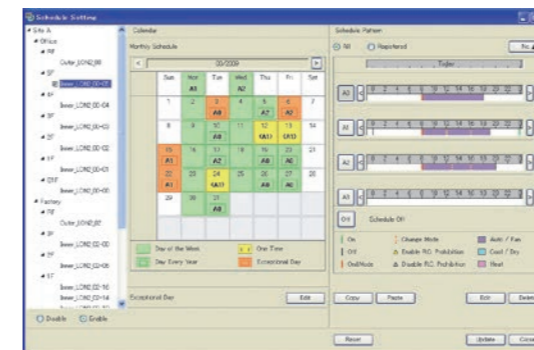

Wide-ranging control of indoor and outdoor units

- The operation status and mode of each indoor unit are displayed.
- Turn on and off each indoor unit and switch its operation mode.
- Setting temperature range limitation
- Low noise setting of outdoor units

Remote controller prohibition

Prohibits the operation mode, temperature setting, or ON/OFF of an indoor unit.

Error alert and e-mail notice

When something goes wrong, an error message is shown in a popup on a computer display with a chime, and an e-mail notice is sent. Errors of the past one year are logged and can be reviewed.

Operation and control history

A history of operation status and control can be maintained and retrieved.

Importing and exporting databases

Only an administrator is authorized to import and export registration, layout, and image data.

Automatic clock adjustment

Time can be set for all controllers in batch automatically.

Electricity charge apportionment

Standard on System controller
Option System controller Lite UTY-PLGXA2

Electricity charge apportionment method

This is a method to calculate monthly energy costs to be allocated to each tenant based on the amount of energy used by their air conditioners. The first step is to determine exactly how much energy is consumed by air conditioners in each tenant space. The second step is to divide the total energy charge billed by an electric power company based on the amount of energy used by each tenant to determine the energy cost to be allocated to each of them. (See figure on right) The calculation takes into consideration such factors as the number of unused rooms and nighttime electricity rate, which are shown in detail on an energy cost allocation schedule.

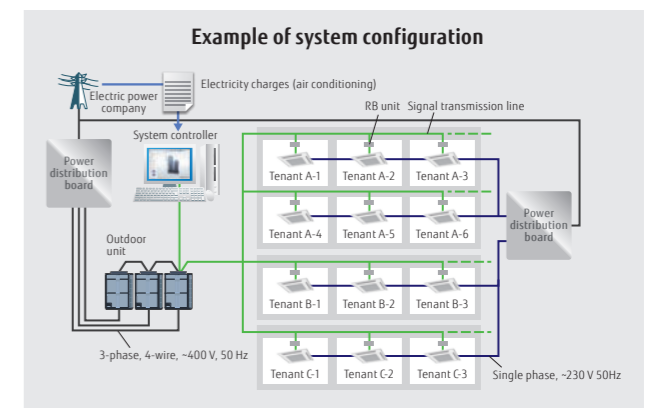

Features:

Remote monitoring management

- Standard on System controller
- Option System controller Lite UTY-PLGXR2

The System controller can be used on site or remotely over networks for remote central control. The System controller requires 2 software programs working together: The VRF controller runs on site and communicates with the VRF system; The VRF explorer, which runs at a remote location, provides a user interface and communicates with the VRF controller. The VRF controller and the VRF explorer run on a single computer or on different computers connected on a network. A computer running VRF explorer can centrally control up to 10 VRF system sites having up to 20 buildings each.

On site central control

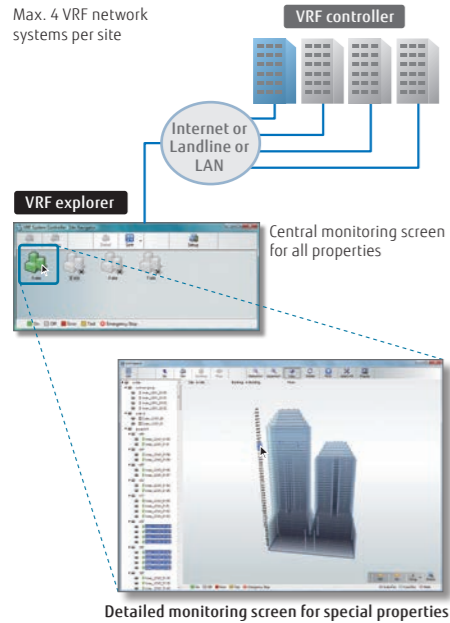

Remote central control

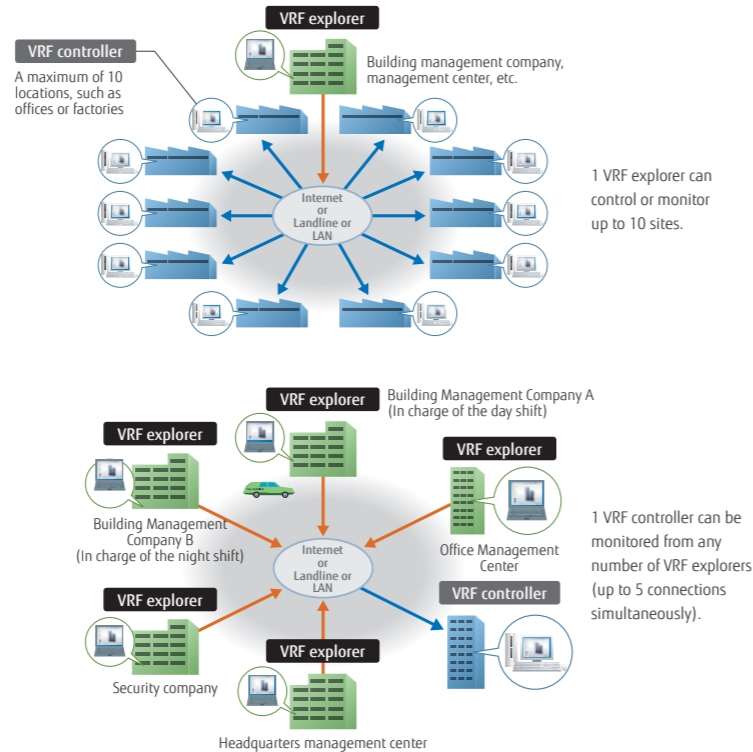

Energy-saving management

- Option System controller UTY-PEGXZ1
- Option System controller Lite UTY-PLGXE2

A variety of energy-saving options can be selected depending on the season, weather, and time of day. Excellent energy-saving operation is performed while keeping users comfortable.

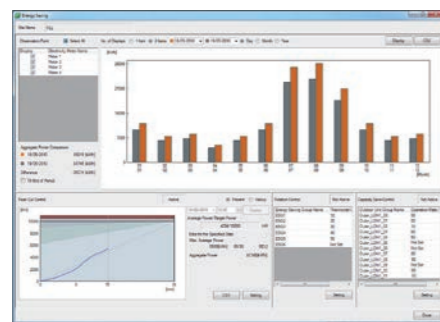

Main screen for energy-saving management

Energy saving graph data: This chart compares the energy consumption for the current month with the previous month and with the same month of the previous year to keep track of the energy-saving performance.

Indoor unit rotation

Indoor units can be automatically rotated to operate within a group in accordance with a predetermined annual schedule to reduce power consumption while keeping users comfortable. The operation stoppage rate can be selected for an indoor unit.

Peak-cut mode

The system controller monitors the connected power meter and controls the energy to maintain the target power consumption set for each time period by changing the set temperature of the indoor units or turning off the thermostat so as to keep the users comfortable. Indoor units to be controlled can be grouped in many ways, and the control level can be set for each group.

Capacity saving for outdoor unit

The upper limit on the capacity of an outdoor unit can be adjusted to reduce power consumption during a hot summer or cold winter by averaging out the power-saving performance of each refrigerant system. The upper limit on capacity can be set at 50% of the rated capacity or more.

Summary of functions

Functions	Type	System controller		System controller Lite				
		UTY-APGXZ1	Option UTY-PEGXZ1	UTY-ALGXZ1	Option UTY-PLGXR2	Option UTY-PLGXA2	Option UTY-PLGXE2	Option UTY-PLGXX2
Specifications	Max. number of VRF networks supported	4	—	1	—	—	—	—
	Max. number of indoor unit and remote controller groups per VRF network	400	—	400	—	—	—	—
	Max. number of outdoor units per VRF network	100	—	100	—	—	—	—
	Max. number of indoor units and remote controller groups per System controller	1600	—	400	—	—	—	—
Site supervision	Multiple site display	10	—	10	—	—	—	—
	Number of buildings per site	20	—	—	—	—	—	—
	Number of floors per site	200	—	—	—	—	—	—
	Number of floors per building	50	—	—	—	—	—	—
	3D graphical layout view	●	—	—	—	—	—	—
	2D graphical layout view	●	—	—	—	—	—	—
	List display	●	—	●	—	—	—	—
Error management	Error notification	●	—	●	—	—	—	—
	Audible alarm	●	—	●	—	—	—	—
	E-mail notification of errors	●	—	●	—	—	—	—
History	Error history	●	—	●	—	—	—	—
	Operation history	●	—	●	—	—	—	—
Operation control	Individual control	ON/OFF	●	—	●	—	—	—
		Operation mode*	●	—	●	—	—	—
		Room temperature	●	—	●	—	—	—
		Fan speed	●	—	●	—	—	—
		Airflow direction	●	—	●	—	—	—
		Economy mode	●	—	●	—	—	—
	Individual management	Setting temperature range limitation	●	—	●	—	—	—
		Anti-freeze	●	—	●	—	—	—
		Low noise setting of outdoor units	●	—	●	—	—	—
	Other	Remote controller prohibition	●	—	●	—	—	—
		Setting temperature range limitation	●	—	●	—	—	—
		Filter sign reset	●	—	●	—	—	—
Schedule	Annual Schedule	memory operations	●	—	●	—	—	—
		Pattern operations	●	—	●	—	—	—
	Annual Schedule	●	—	●	—	—	—	
	Setting for a specific date	●	—	●	—	—	—	
	ON/OFF per day	72	—	72	—	—	—	
	ON/OFF per week	504	—	504	—	—	—	
	Day off	●	—	●	—	—	—	
	Minimum unit of timer setting (minutes)	10	—	10	—	—	—	
	Weekly schedule for low noise mode	●	—	●	—	—	—	
	Remote monitoring management	Web Operation	●	—	●	—	—	—
Remote monitoring		●	—	●	—	—	—	
Remote operation control		●	—	●	—	—	—	
Remote function setting		●	—	●	—	—	—	
Electricity charge apportionment	Apportionment charge/bill calculation	●	—	●	—	—	—	
	Tenant (block) setting	●	—	●	—	—	—	
	Common facilities apportionment setting	●	—	●	—	—	—	
	Rated power consumption allotment	●	—	●	—	—	—	
Energy-saving management	Individual calculations for cooling and heating	—	●	—	●	—	—	
	Electricity meter supported	—	●	—	●	—	—	
	Indoor unit rotation	—	●	—	●	—	—	
	Peak cut control	—	●	—	●	—	—	
	Capacity saving for outdoor unit	—	●	—	●	—	—	
Control of external devices	Record of energy-saving operation	—	●	—	●	—	—	
	Information on energy saving	—	●	—	●	—	—	
	Power consumption monitor	—	●	—	●	—	—	
	Electricity meter supported	—	●	—	●	—	—	
Others	Monitor	●	—	●	—	—	—	
	Control	●	—	●	—	—	—	
	Importing and exporting databases	●	—	●	—	—	—	
	Automatic clock adjustment	●	—	●	—	—	—	
	Multiple language support	7 languages	—	7 languages	—	—	—	
Refrigerant leak detector	●	—	●	—	—	—		
Power shutdown	●	—	●	—	—	—		

●: Available - : Not available

Computer requirements

The specifications required for the computer are shown in the table below:

	System controller	System controller Lite
Operating system	<ul style="list-style-type: none"> Microsoft® Windows® 7 Home Premium (32-bit or 64-bit) SP1, Windows® 7 Professional (32-bit or 64-bit) SP1 Microsoft® Windows® 8.1 (32-bit or 64-bit), Windows® 8.1 Pro (32-bit or 64-bit) Microsoft® Windows® 10 Home (32-bit or 64-bit), Windows® 10 Pro (32-bit or 64-bit) Supports 7 languages: English, Chinese, French, German, Russian, Spanish, and Polish	<ul style="list-style-type: none"> Microsoft® Windows® 7 Home Premium (32-bit or 64-bit) SP1, Windows® 7 Professional (32-bit or 64-bit) SP1 Microsoft® Windows® 8.1 (32-bit or 64-bit), Windows® 8.1 Pro (32-bit or 64-bit) Microsoft® Windows® 10 Home (32-bit or 64-bit), Windows® 10 Pro (32-bit or 64-bit) Supports 7 languages: English, Chinese, French, German, Russian, Spanish, and Polish
CPU	Intel® Core™ i3 2 GHz or higher	Intel® Core™ i3 2 GHz or higher
Memory	<ul style="list-style-type: none"> 2 GB or more (for Windows® 7 [32-bit]) 4 GB or more (for Windows® 7 [64-bit], Windows® 8.1, and Windows® 10) 	<ul style="list-style-type: none"> 2 GB or more (for Windows® 7 [32-bit]) 4 GB or more (for Windows® 7 [64-bit], Windows® 8.1, and Windows® 10)
HDD	40 GB or more of free space	40 GB or more of free space
Displayed items	1024 × 768 or higher resolution	1024 × 768 or higher resolution
Interfaces	<ul style="list-style-type: none"> Ethernet port (for getting access to the internet using LAN) or a modem (for getting access to the internet via landline) Up to 6 USB ports (Only required for a server computer working as a VRF controller) - Maximum of 2 USB ports are required to connect to a White-USB-key/WibuKey - Up to 4 USB ports required to connect to an Echelon® U10 USB network interface * Maximum number of required USB ports depends on the applicable system configuration. 	<ul style="list-style-type: none"> Ethernet port (for getting access to the internet using LAN) or a modem (for getting access to the internet via landline) Up to 6 USB ports (Only required for a server computer working as a VRF controller) - Maximum of 4 USB ports are required to connect to a White-USB-key/WibuKey - 1 USB port is required for an Echelon® U10 USB Network interface * The maximum number of required USB ports depends on the applicable system configuration.
Graphic accelerator	Microsoft® DirectX® 9.0c compatible	Microsoft® DirectX® 9.0c compatible
Software	Adobe® Acrobat Reader® 9.0 or later	Adobe® Acrobat Reader® 9.0 or later

* Echelon® U10 USB Network interface - TP/FT-10 Channel (Model name: 75010R) (Required for each VRF Network)

Packing list

Type	For System controller			For System controller Lite			
	System controller	Option Energy manager	System controller Lite	Remote access	Electricity charge apportionment	Energy saving	Centralized control
Model name	UTY-APGXZ1	UTY-PEGXZ1	UTY-ALGXZ1	UTY-PLGXR2	UTY-PLGXA2	UTY-PLGXE2	UTY-PLGXX2
White-USB-key	1	1	1	1	1	1	1

*1: Software protection key to be inserted in a USB slot running System controller or System controller Lite. System controller or System controller Lite may only run on a PC with a WHITE-USB-KEY. However, a WHITE-USB-KEY is not required for remote VRF explorer software.

MODBUS® converter for indoor unit

UTY-VMSX



Up to
1 indoor unit

MODBUS® converter enables air conditioners to be fully integrated into a MODBUS® network.

- Simple installation due to small and compact size.
- No separate external power supply required.
- The MODBUS® converter must be connected to an indoor unit on a one-to-one basis.
- The MODBUS® converter enables central monitoring and control of air conditioners from BMS, central, or home controller.

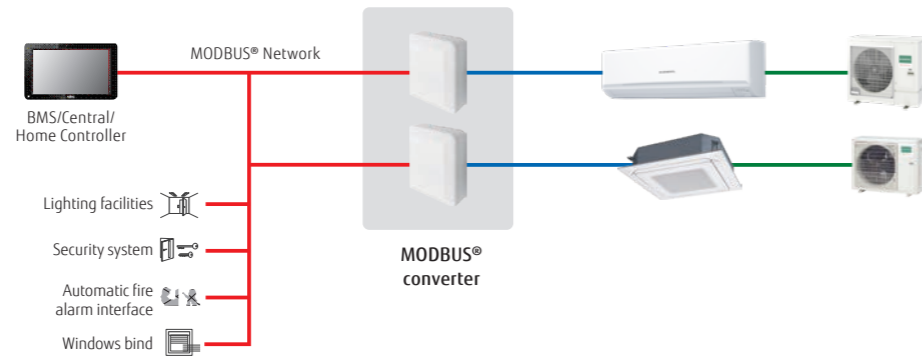

Easy Installation

Easy to install with minimal wiring and without the need for a power supply cable to the converter

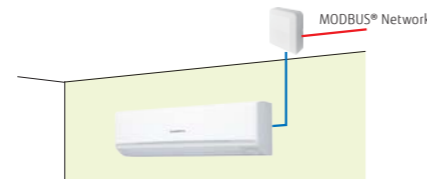

Basic control

- Turning the units on and off
- Mode control (Heat, Cool, Dry, Auto, Fan)
- Fan speed control
- Louver position (airflow direction setting)
- Room temperature setting and display
- Economy mode setting
- Error status

Specifications

Model name	UTY-VMSX
Power supply	12 V DC
Input power (W)	Max. 1.2 W
Dimensions (H × W × D) (mm)	140 × 117 × 43
Weight (g)	200
Maximum number of connectable indoor units per MODBUS® converter	1

Modbus communication specifications

Transfer mode	RTU mode
Communication speed	9600/19200 bps
Data bit	8
Parity	even/odd/none
Stop bit	1/2 (no parity)
Network	RS485
Maximum cable length	1000 m (3280 ft)

MODBUS® interface

FG-RC-MBS1Z1 / FG-AC-MBS1Z1 / FG-IR-BMG1Z1



FG-RC-MBS1Z1
(3-wire RC-line type)



FG-AC-MBS1Z1
(CN connector type)



FG-IR-BMG1Z1
(IR type)

Up to
1 indoor unit

MODBUS® interface enables air conditioners to be fully integrated into a MODBUS® network.

- Small, compact, and easy to install on DIN rails.
- No separate external power supply required.
- MODBUS® interface enables central monitoring and control of air conditioners from BMS.

Installation example

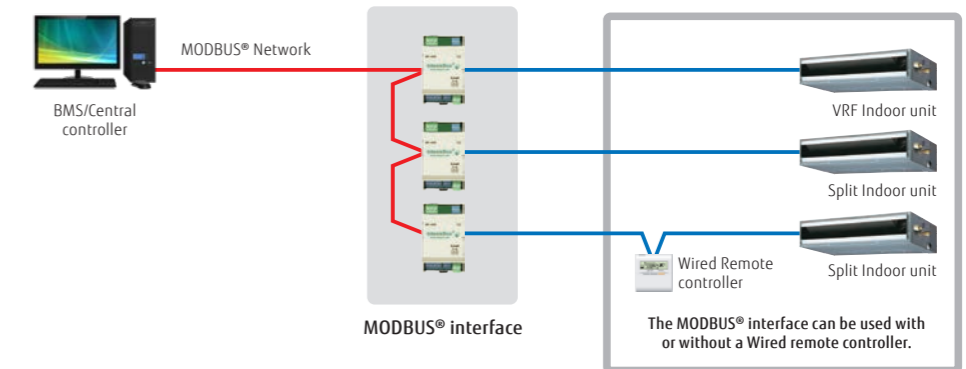

[IR type] Connection to wall-mounted type

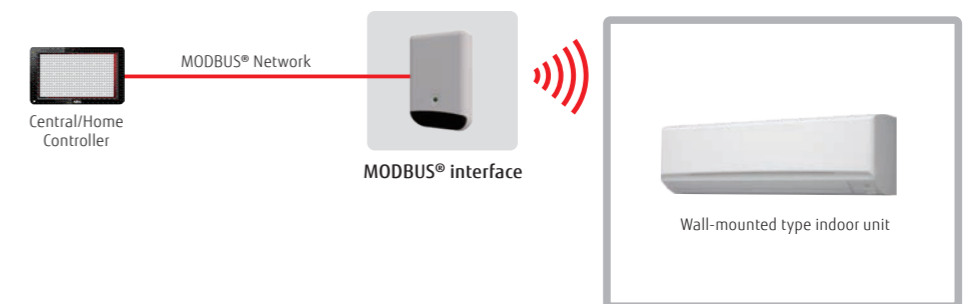

Specifications

Model name	FG-RC-MBS1Z1 (3-wire RC-line type)	FG-AC-MBS1Z1 (CN connector type)	FG-IR-BMG1Z1 (IR type)
Number of controllable groups	1	1	1
Dimensions (H × W × D) (mm)	93 × 53 × 58	93 × 53 × 58	93 × 60 × 21
Weight (g)	85	85	55

MODBUS® convertor for VRF

UTY-VMGX / FG-TL-MBS16Z1

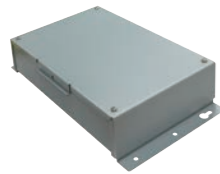

UTY-VMGX

Up to
9 units per VRF system
Up to
100 outdoor units
Up to
128 indoor units

MODBUS® convertor enables air conditioners to be fully integrated into a MODBUS® network.

- Compact and lightweight design
- Direct connection to MODBUS® network
- MODBUS® convertor enables central monitoring and control of air conditioners from BMS or a central controller.
- Up to 9 converters can be connected to a VRF network (UTY-VMGX). Simultaneous control, such as Power ON/ OFF and temperature setting, can be performed for each zone.
- If a connection error occurs after installation work is completed, the source of the error can be located easily.

Installation example



FG-TL-MBS16Z1

Up to
16 indoor units
Up to
16 outdoor units
Up to
128 indoor units

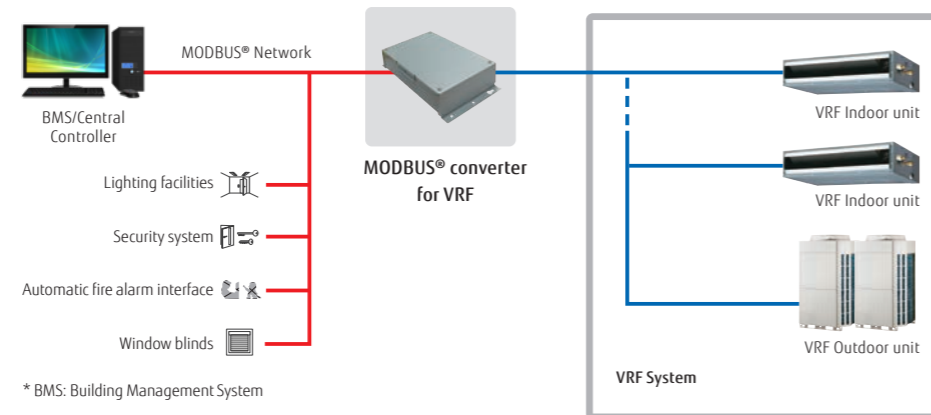

* BMS: Building Management System

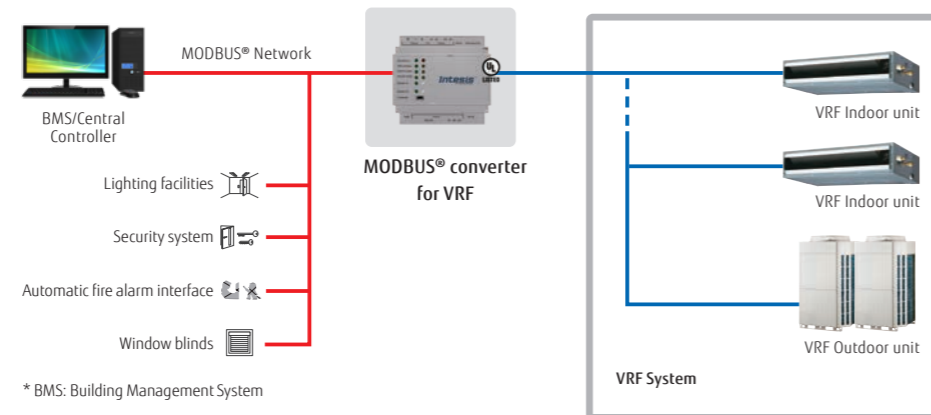

* BMS: Building Management System

Specifications

Model name	UTY-VMGX	FG-TL-MBS16Z1
Power supply	Single phase ~220 to 240 V 50/60 Hz	9 to 36 V DC, Max.: 140 mA or 24 V AC 50/60 Hz, Max.: 127 mA.*
Input power (W)	Max. 2	1.7
Dimensions (H × W × D) (mm)	54 × 260 × 150	90 × 88 × 56
Weight (g)	1,100	330

*24 V DC power supply is recommended.

BACnet® interface

FG-AC-BAC1Z1 / FG-IR-BMG1Z1



FG-AC-BAC1Z1 (CN connector type)



FG-IR-BMG1Z1 (IR type)

Up to
1 indoor units

- BACnet® interface connects BMS and a Fujitsu General split/multi-split/VRF system.
- Compatible with BACnet® (ANSI/ASHRAE-135-2012) application-specific controller (B-ASC)
- Compatible with BACnet®/IP over Ethernet.

Installation example

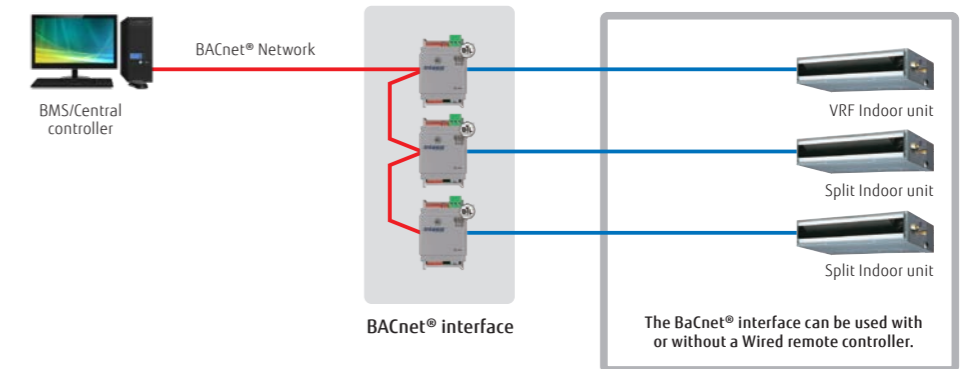

[IR type] Connection to wall-mounted type

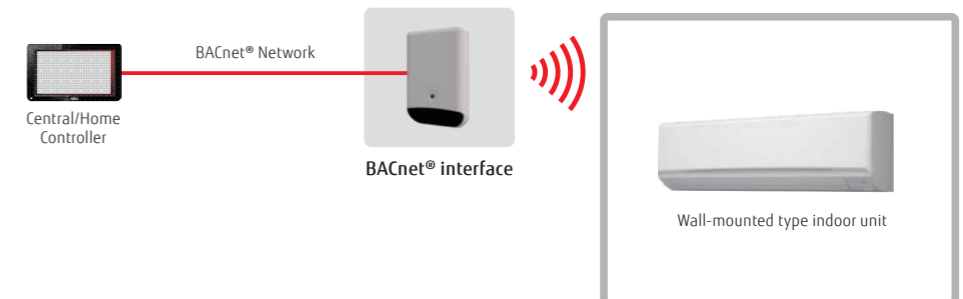

Specifications

Model name	FG-AC-BAC1Z1 (CN connector type)	FG-IR-BMG1Z1 (IR type)
Number of controllable groups	1	1
Dimensions (H × W × D) (mm)	93 × 53 × 58	93 × 60 × 21
Weight (g)	85	55

12 V DC supplied by an indoor unit

BACnet® gateway

UTY-ABGXZ1 (Software)



White-USB-key
(Software Protection Key)



BACnet® is a registered trademark of ASHRAE. ASHRAE does not endorse, approve or test products for compliance with ASHRAE standards. Compliance of listed products to the requirements of ASHRAE Standard 135 is the responsibility of BACnet International (BI). BTL is a registered trademark of BACnet International.

Up to
4 VRF network systems
Up to
400 outdoor units
Up to
1,600 indoor units

Installation example

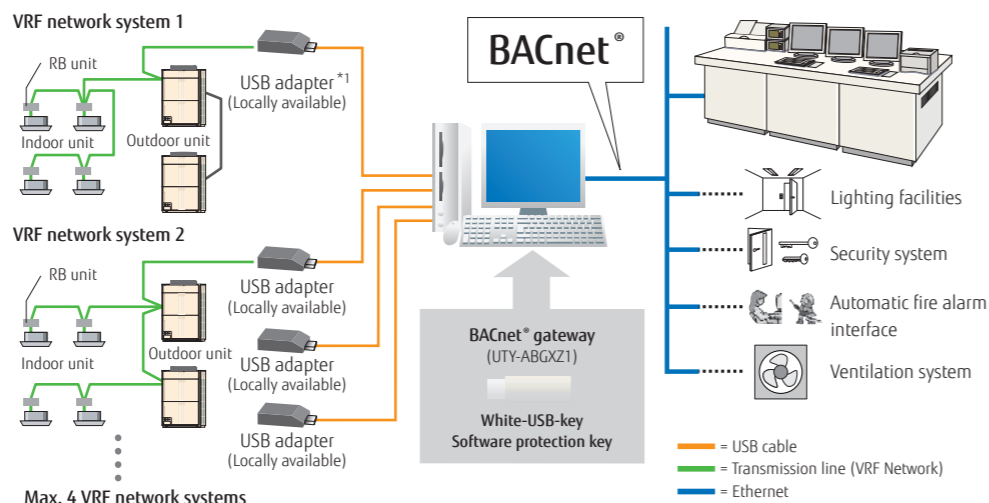

*1: U10 USB network interface available from Echelon® Corporation.

Computer requirements

	UTY-ABGXZ1
Operating system	<ul style="list-style-type: none"> Microsoft® Windows® 7 Home Premium (32-bit or 64-bit) SP1, Windows® 7 Professional (32-bit or 64-bit) SP1 Microsoft® Windows® 8.1 (32-bit or 64-bit), Windows® 8.1 Pro (32-bit or 64-bit) Microsoft® Windows® 10 Home (32-bit or 64-bit), Windows® 10 Pro (32-bit or 64-bit) Supported languages: Chinese, English, French, German, Polish, Russian, and Spanish
CPU	Intel® Core™ i3 2 GHz or higher
Memory	<ul style="list-style-type: none"> 2 GB or more (for Windows® 7 [32-bit]) 4 GB or more (for Windows® 7 [64-bit], Windows® 8.1, and Windows® 10)
HDD	40 GB or more of free space
Displayed items	1024 × 768 or higher resolution
Interfaces	<ul style="list-style-type: none"> Ethernet port (for getting access to the internet using LAN) Up to 5 USB ports - 1 USB port required to connect to a White-USB-key/WibuKey - Up to 4 USB ports required to connect to an Echelon® U10 USB network interface *The maximum number of required USB ports varies depending on the applicable system configuration.
Software	Adobe® Acrobat Reader® 9.0 or later

*Echelon® U10 USB Network interface – TP/FT-10 Channel (Model name: 75010R) (Required for each VRF Network)

Packing list

Name and shape	Quantity	Application
White-USB-key	1	Includes the software, user's manual, and license for BACnet® gateway.

BACnet® gateway

UTY-VBGX (Hardware)



BACnet® is a registered trademark of ASHRAE. ASHRAE does not endorse, approve or test products for compliance with ASHRAE standards. Compliance of listed products to the requirements of ASHRAE Standard 135 is the responsibility of BACnet International (BI). BTL is a registered trademark of BACnet International.

Up to
1 VRF network systems
Up to
32 refrigerant systems
Up to
128 indoor units

Installation example

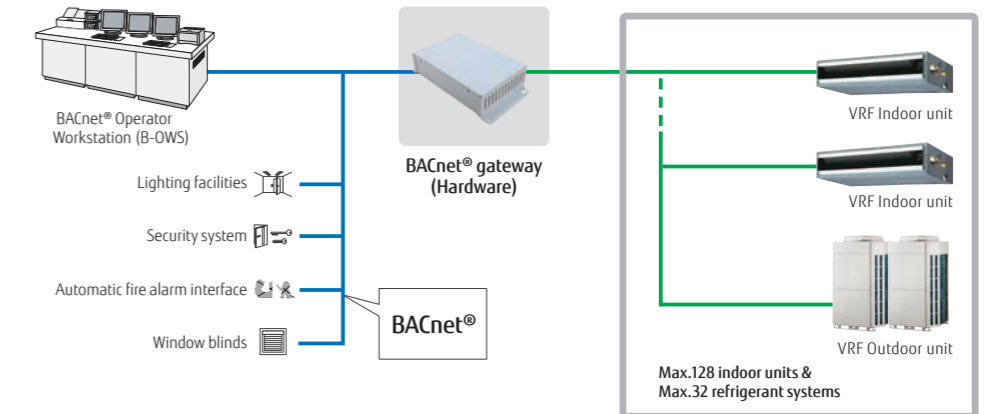

Specifications

Model name	UTY-VBGX
Number of controllable indoor units	128
Number of controllable refrigerant systems	32
Number of controllable VRF networks	1
Number of connectable units / one VRF network	4
Power supply	Single phase, 100-240 V, 50/60 Hz
Power consumption (W)	4.6 (max.)
Dimensions (H × W × D) (mm)	59.6 × 270.4 × 176
Weight (g)	1200

BACnet®/MODBUS® router

FG-RTR-BAC32Z1 / FG-RTR-MBS32Z1



FG-RTR-BAC32Z1 (BAC net)



FG-RTR-MBS32Z1 (MODBUS®)

Routing between BaCnet® MS/TP and BaCnet® IP networks

- Routing between BaCnet® MS/TP and BaCnet® IP networks
- Routing between MODBUS® RTU and MODBUS® TCP networks

Installation example

[BaCnet® type]

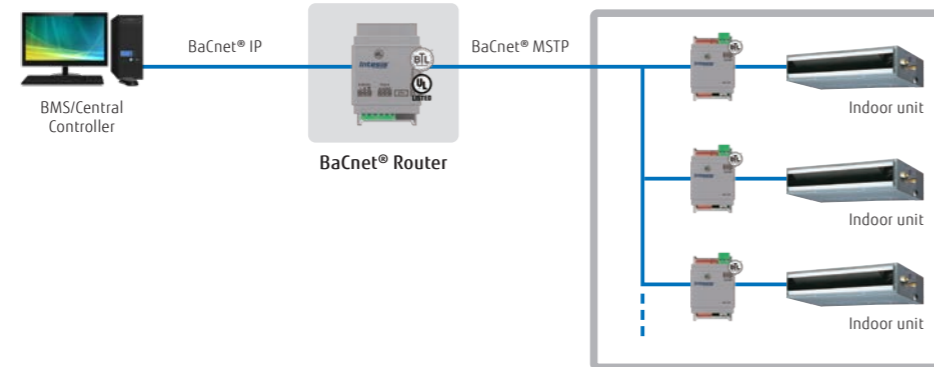

[MODBUS® type]

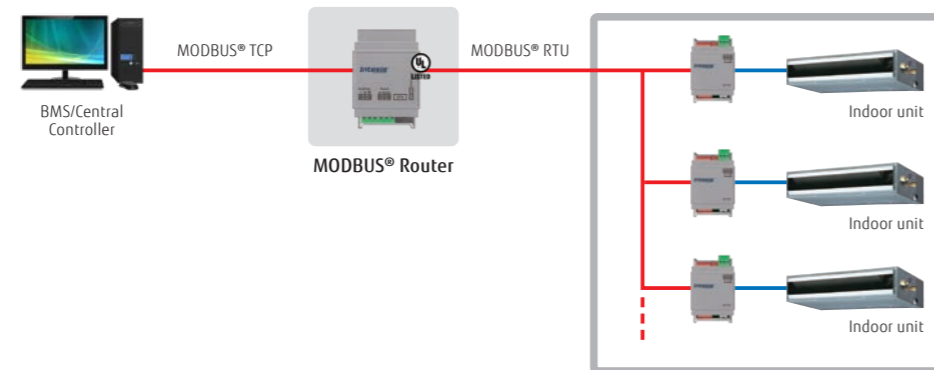

Specifications

Model name	FG-RTR-BAC32Z1 (MS/TP to IP)	FG-RTR-MBS32Z1 (RTU to TCP)
Number of routable devices (max.)	32	32
Power supply	9 to 36 V DC, Max.: 140 mA or 24 V AC 50/60 Hz, Max.: 127 mA	9 to 36 V DC, Max.: 140 mA or 24 V AC 50/60 Hz, Max.: 127 mA
Power consumption (W)	1.7	1.7
Dimensions (H × W × D) (mm)	93 × 53 × 58	93 × 53 × 58
Weight (g)	150	150

BACnet®/MODBUS® cloud device

FG-CLD-BMG4Z1 / FG-CLD-BMG8Z1 / FG-CLD-BMG16Z1 / FG-CLD-BMG32Z1



FG-CLD-BMG4Z1

- The most powerful configuration tool common to all BACnet® gateways provides the system integrators with the power to configure and monitor their systems in an easy and reliable manner.
- A simple, easy-to-use description for the ST Cloud Web and App User Interface, with all widgets customizable to the user's needs, enabling system integrators to easily offer the best user experience to customers who are in control of their BaCnet® or MODBUS® devices.

Installation example

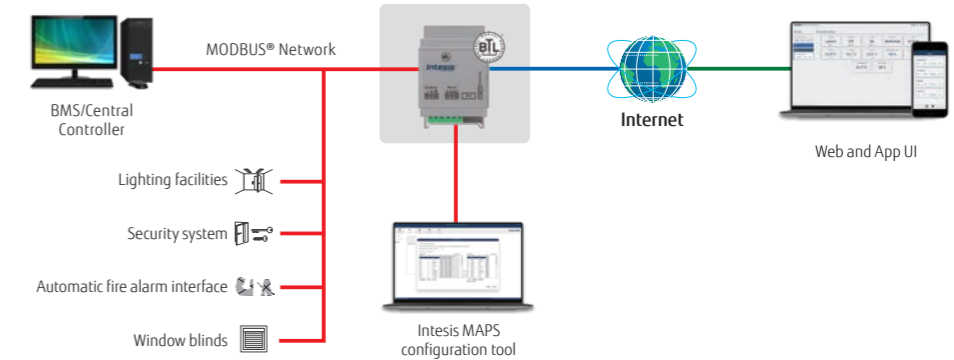

*BMS: Building Management System

Gateway features

- BaCnet® IP/MSTP or MODBUS® TCP/RTU connectivity
- Up to 32 devices can be connected to each gateway.
- Up to 12 widgets per device
- Easy device configuration with Intesis MAPS

Next-generation services

- Industrial-grade connectivity now for building automation
- Fast and scalable real-time edge connectivity over HMS HubTM
- Full data control and protection
- Secure and remote updates during the application lifetime

System Features

- Monitor and control all devices in an intuitive way
- Comes with a native iOS and Android app and a web interface
- Create scenes and interact with multiple concurrent devices
- Calendar that shows the daily planned installation commands
- Notifications keep you updated about system status
- Device sharing and usage permissions management
- Multiple site management from a common dashboard

Specifications

Model name	FG-CLD-BMG4Z1	FG-CLD-BMG8Z1	FG-CLD-BMG16Z1	FG-CLD-BMG32Z1
Number of connectable BaCnet® (IP/MSTP) or MODBUS® (TCP/RTU) devices	4	8	16	32
Power supply	9 to 24 V DC, 50/60Hz	9 to 24 V DC, 50/60Hz	9 to 24 V DC, 50/60Hz	9 to 24 V DC, 50/60Hz
Power consumption (W)	1.7	1.7	1.7	1.7
Dimensions (H × W × D) (mm)	93 × 53 × 58	93 × 53 × 58	93 × 53 × 58	93 × 53 × 58
Weight (g)	150	150	150	150

KNX® converter for indoor unit

UTY-VKSX



Up to
1 indoor unit

KNX® Converter enables individual control of an indoor unit.

- The new KNX® converter connects a central or home controller and a Fujitsu General indoor unit.
- Compact and lightweight design

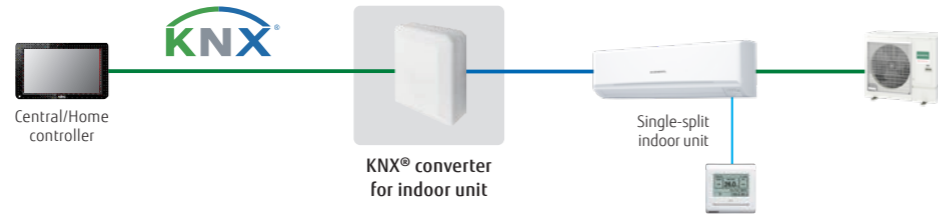

KNX® converter for VRF

UTY-VKGX / FG-TL-KNX16Z1

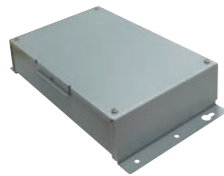

UTY-VKGX

Up to
100 outdoor units
Up to
128 indoor units



FG-TL-KNX16Z1

Up to
16 indoor units
Up to
16 outdoor units

KNX® converter enables centralized control of a system.

- KNX® converter connects a central or home controller and a Fujitsu General VRF system.
- Up to 128 indoor units and 100 outdoor units can be connected to a single KNX® converter. (UTY-VKGX)

Installation example

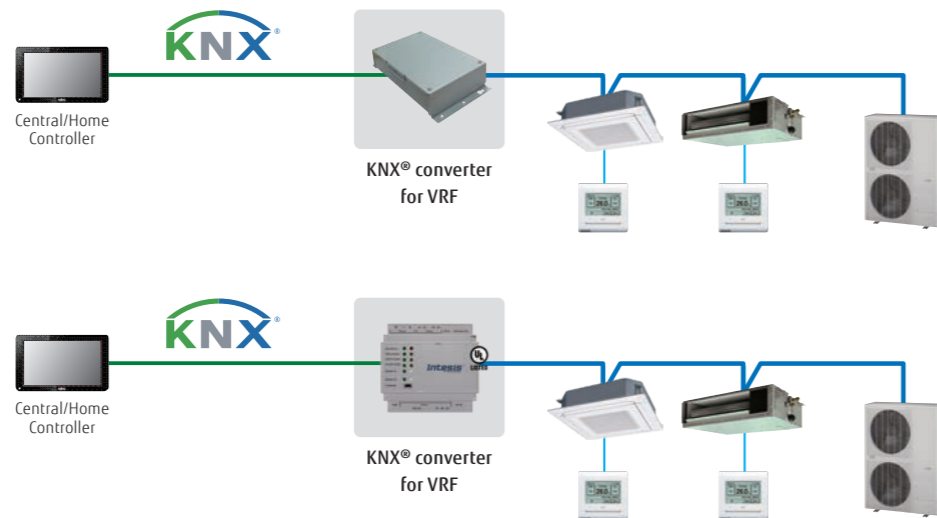

Specifications

Model name	UTY-VKSX	UTY-VKGX	FG-TL-KNX16Z1
Power supply	12 V DC	Single phase ~220 to 240 V 50/60 Hz	9 to 36 V DC, Max.: 140 mA or 24 V AC 50/60 Hz, Max.: 127 mA.*
Input power (W)	0.6	1.5	1.6
Dimensions (H × W × D) (mm)	140 × 117 × 43	54 × 260 × 150	90 × 88 × 56
Weight (g)	215	1,200	340

*24 V DC power supply is recommended.

KNX® interface

FG-RC-KNX1Z1 / FG-AC-KNX1Z1 / FG-IR-KNX1Z1



Intesis®



FG-RC-KNX1Z1
(3-wire RC-line type)

Intesis®



FG-AC-KNX1Z1
(CN connector type)

Intesis®



FG-IR-KNX1Z1
(IR type)

Up to
1 indoor unit

The KNX® interface enables air conditioners to be fully integrated into a KNX® network system.

- Simple installation due to small and compact size.
- No separate external power supply required (only KNX® bus power required)

Installation example

[3-wire RC-line type/CN connector type]

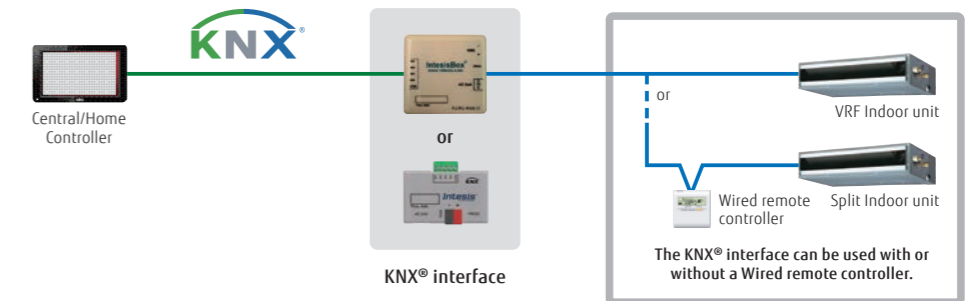

[IR type] Connection to wall-mounted type

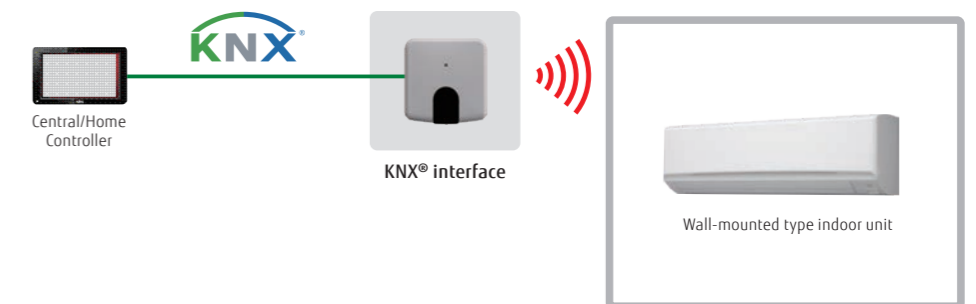

[IR type] Connection to a product other than wall-mounted type

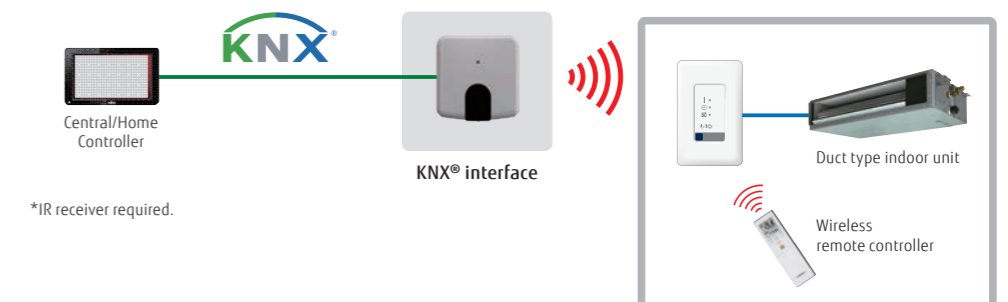

Specifications

Model name	FG-RC-KNX1Z1 (3-wire RC-line type)	FG-AC-KNX1Z1 (CN connector type)	FG-IR-KNX1Z1 (IR type)
Number of controllable groups	1	1	1
Dimensions (H × W × D) (mm)	70 × 70 × 28	45 × 59 × 21	81 × 78 × 28
Weight (g)	70	35	76

Network converter for single-split type

UTY-VTGX / UTY-VTGXV



UTY-VTGX
DC power supply type

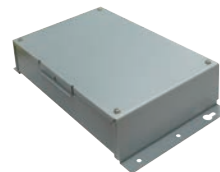

UTY-VTGXV
AC power supply type

Up to
16 single indoor units
Up to
1 group
Up to
100 Network Converters

- A network converter is required when connecting a single-split system to a VRF network system.
- Compact and lightweight design
- Connectable to both nonpolar 2-core and polar 3-core remote controllers

Installation example

- A 1-remote-controller type and a 2-remote-controller type are available.
- Power supply (220 to 240 V AC, 50/60 Hz) is required for the 2-remote-controllers type.

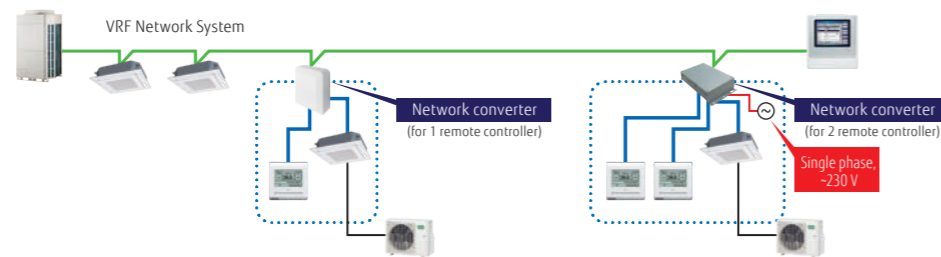

- Both nonpolar 2-core and polar 3-core type Wired remote controllers can be connected.

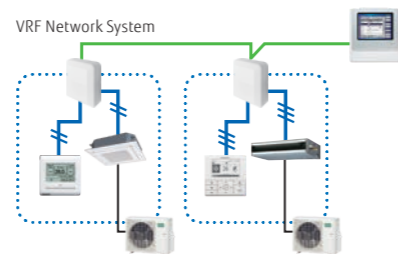

- Central control can be provided for single-split systems. (Up to 100 network converters can be connected in a VRF network system)

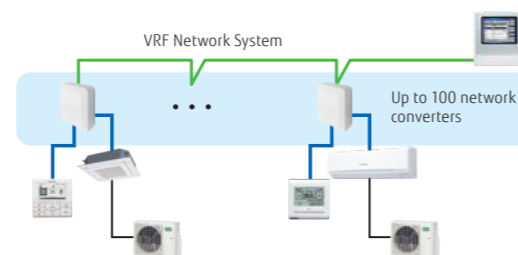

Specifications

Model name	UTY-VTGX		UTY-VTGXV
	Power supply	Polar 3-core 12 V DC	Nonpolar 2-core DC 12 V
Input power (W)	Max. 1.2 W		Max. 3
Dimensions (H × W × D) (mm)	140 × 117 × 43		54 × 260 × 150
Weight (g)	250		1,100

Network converter for LONWORKS™

UTY-VLGX

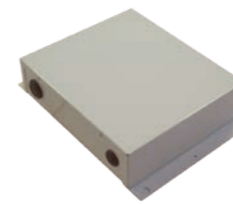

Up to
4 units to BMS
Up to
100 outdoor units
Up to
128 indoor units

- Connects the VRF network system to a LONWORKS™ open network to manage small and mid-sized BMS and VRF network system.
- The UTY-VLGX enables centralized monitoring and control of VRF network system from a BMS via a LONWORKS™ interface.
- Up to 128 Indoor units can be connected to one network converter for LONWORKS™

Installation example

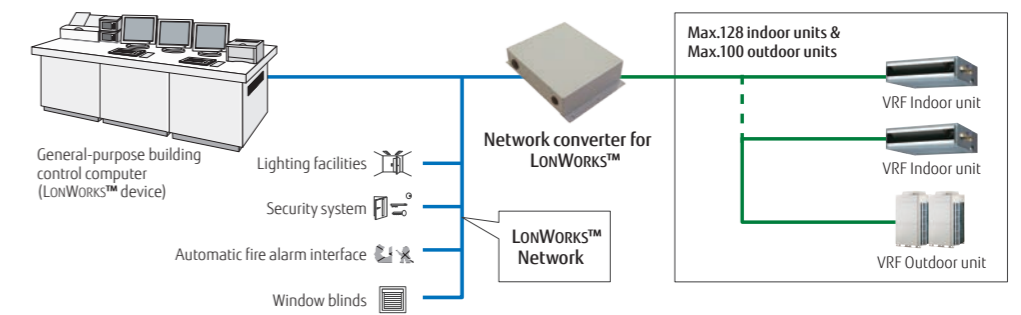

Specifications

Model name	UTY-VLGX
Power supply	Single phase ~208 to 240 V 50/60 Hz
Power consumption (W)	4.5
Dimensions (H × W × D) (mm)	67 × 288 × 211
Weight (g)	1,500

Transmission specifications (BMS side)

Transmission speed	78 kbps
Transceiver	FT-X1 (available from Echelon® Corporation)
Transmission line form	Free topology
Terminal resistor	None (converter to be attached at the terminal of a network)

External switch controller

UTY-TERX



Up to
1 group

Air conditioner switching can be controlled by connecting this external switch controller to other sensor switches.

- In combination with a commercially available card-key switch or other sensors, this External switch controller enables the control of ON/OFF, room temperature, and fan speed of connected air conditioners as well as master control functions. This makes this product an ideal choice for use in hotel rooms.
- Card key or other sensor switches are locally available.
- The set temperature can be specified at two points each for cooling and heating operations (4 points in total).

Installation example

Human sensor monitors the movement of a person in a room. When it detects that the person has left the room, it switches the air conditioner to low-capacity mode. When a person returns to the room, the air conditioner returns to the previous operation mode.

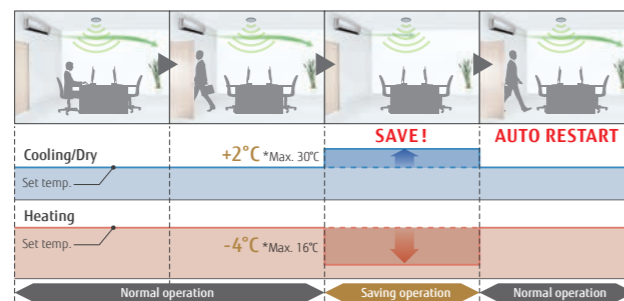

Human sensor equipment needs to be purchased separately.
Human sensor is not mounted on an External switch controller.

Signal amplifier

UTY-VSGXZ1

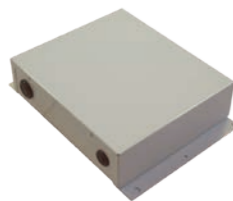

- The transmission line can be extended up to 3,600 m using multiple Signal amplifiers.
- Up to 8 Signal amplifiers can be added in a VRF network system.
- A Signal amplifier is required.
 - (1) When the total wiring length of the transmission line exceeds 500 m.
 - (2) When the total number of units on the transmission line exceeds 64.

Installation example

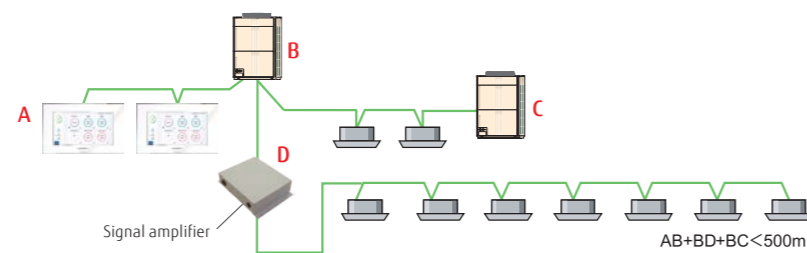

Specifications

Model name	UTY-VSGXZ1	UTY-TERX
Power supply	Single phase ~208 to 240 V 50/60 Hz	6.5 to 16 V DC
Power consumption (W)	4.5	-
Dimensions (H × W × D) (mm)	67 × 288 × 211	140 × 117 × 43
Weight (g)	1,500	250

12 V DC supplied by an indoor unit

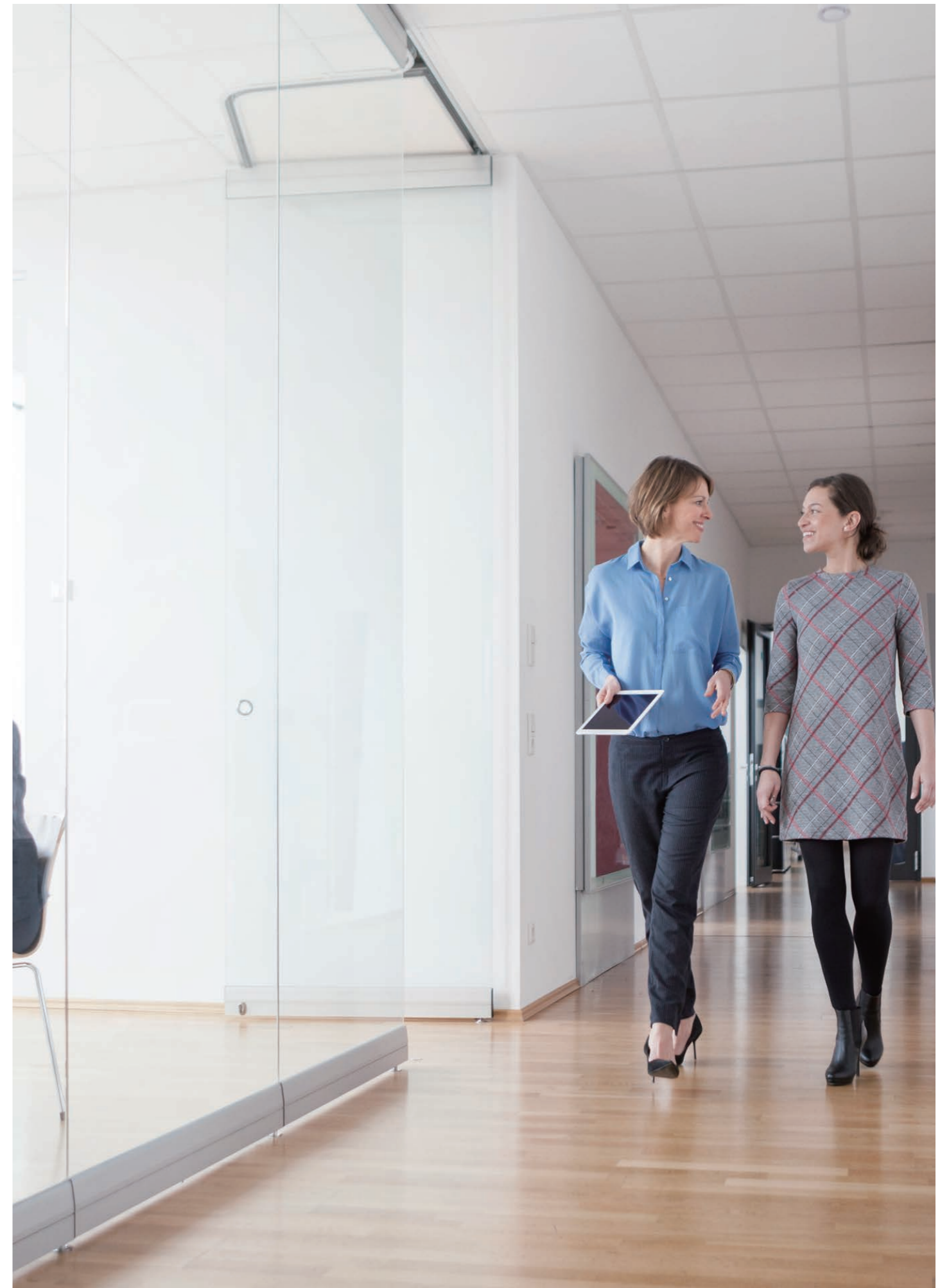

Controller system list (available) for Split/Multi-split

Controller Options/Accessories:



Type	Refrigerant	Indoor unit																							Outdoor unit		
		Wall-mounted									Cassette		Duct										Multi-split				Single phase
		Designer Range		Standard Range			ECO Range				Compact 4-way flow Range	Circular flow Range	Slim	Medium static pressure (High efficiency & EcoStar)	Medium static pressure (Compact)	Medium static pressure (Standard)	High static pressure	BIG	Floor	Ceiling	Wall-mounted	Compact cassette	Mini duct	Slim duct	5/6-unit multi-split		
ASHH07/09/12/14KGTG, ASHG07/09/12/14KGTG, ASHG07/09/12/14KGTG	ASHG 07/09/12/14 KETI, KETI-B, KETE, KETE-B	ASHH07/09/12/14KMG, ASHG07/09/12/14KMG, ASHG07/09/12/14KMG	ASHG 18/24KMT	ASHH 30/36KMTB	ASHH 07/09/12 KNCA	ASHG 07/09/12 KPCE	ASHH 07/09/12 KLTA	AUXG 09/12/14/18/22/24 KVLA	AUXG 18/22/24/30/36/45/54 KRLB	ARXG 09/12/14/18 KLLAP	ARXH 12/14/18/22/24/30/36/45/54 KMTP	ARXG 12/14/18/22/24/30/36/45/54 KHTAP	ARXG 24/30/36/45 KMLA	ARXG 45/54KHTB	ARHG 60LHTA	ARHG 72/90LHTA	AGHG 09/12/14 KVCA	ABHG 18/22/24/30/36/45/54 KRTA	ASHH 05KNCA	ASHG 22KMT	AUXG 07KVLA	ARXG 07/09/12/14/18 KSLAP	ARXG 07KLLAP	AOHG 36KBTA5			
R410A																								AOHG 45LBLA6			
Wired remote controller		● UTY-RVRG+ UTY-TWRXZ2									● UTY-RVRG		● UTY-RVRG										● UTY-RVRG+ UTY-TWRXZ2				● UTY-RVRG
		● UTY-RNRGZ5+ UTY-TWRXZ2									● UTY-RNRGZ5		● UTY-RNRGZ5										● UTY-RNRGZ5+ UTY-TWRXZ2				● UTY-RNRGZ5
		● UTY-RLRG+ UTY-TWRXZ2									● UTY-RLRG		● UTY-RLRG										● UTY-RLRG+ UTY-TWRXZ2				● UTY-RLRG
		● UTY-RCRGZ1+ UTY-TWRXZ2									● UTY-RCRGZ1		● UTY-RCRGZ1										● UTY-RCRGZ1+ UTY-TWRXZ2				● UTY-RCRGZ1
											● UTY-RVNGM		● UTY-RVNGM										● UTY-RVNGM				● UTY-RVNGM
											● UTY-RNNGM		● UTY-RNNGM										● UTY-RNNGM				● UTY-RNNGM
Simple remote controller	 Nonpolar 2-core type	● UTY-RSRG UTY-RHRG+ UTY-TWRXZ2									● UTY-RSRG UTY-RHRG		● UTY-RSRG UTY-RHRG										● UTY-RSRG UTY-RHRG+ UTY-TWRXZ2				● UTY-RSRG UTY-RHRG
Home central remote controller																									● UTY-DMMGM1*3 (KBTA5) UTY-DMMGM*3 (LBLA6)		
Wireless remote controller											● UTY-LNTG												● UTY-LNTG				
IR receiver unit with Wireless remote controller	 For Duct type												● UTY-LRHGM														
	 For Duct type For Cassette type For Ceiling type										● UTY-LBTGC		● UTY-LBTGM										● UTY-LBTGM				● UTY-LBTGM

*1: Available only when the WLAN adapter (UY-TFSXF2) is removed. *2 Available only when the WLAN adapter (UY-TFSXZ1) is removed. *3 Consult your dealer for conditions of use.

Controller system list (available) for Split/Multi-split

Controller Options/Accessories:



Type	Refrigerant	Indoor unit																											
		Wall-mounted									Cassette		Duct						Floor		Ceiling		Multi-split						
		Designer Range		Standard Range			ECO Range				Compact 4-way flow Range	Circular flow Range	Slim	Medium static pressure (High Efficiency & Ambient)	Medium static pressure (Compact)	Medium static pressure (Standard)	High static pressure	BIG	Floor	Ceiling	Wall-mounted	Compact cassette	Mini duct	Slim duct					
ASHH07/09/12/14KGTG, ASHG07/09/12/14KGTG, ASHG07/09/12/14KGTG	ASHG 07/09/12/14 KETE, KETE-B	ASHH07/09/12/14KMG, ASHG07/09/12/14KMG, ASHG07/09/12/14KMG	ASHG 18/24KMT	ASHH 30/36KMTB	ASHH 07/09/12 KNCA	ASHG 07/09/12 KPCE	ASHH 07/09/12 KLTA	ASHG 18/24KLCA	AUXG 09/12/14/18/22/24 KVLA	AUXG 18/22/24/30/36/45/54 KRLB	ARXG 09/12/14/18 KLLAP	ARXH 12/14/18 22/24/30/36/45/54 KMTAP	ARXG 12/14/18/22/24/30/36/45/54 KHTAP	ARXG 24/30/36/45 KMLA	ARXG 45/54KHTB	ARHG 60LHTA	ARHG 72/90LHTA	AGHG 09/12/14 KVCA	ABHG 18/22/24/30/36/45/54 KRTA	ASHH 05KNCA	ASHG 22KMT	AUXG 07KVLA	ARXG 07/09/12/14/18 KSLAP	ARXG 07KLLAP					
Interfacing	MODBUS® Converter	● UTY-VMSX									● UTY-VMSX		● UTY-VMSX						● UTY-VMSX*2		● UTY-VMSX		● UTY-VMSX*1				● UTY-VMSX		
	MODBUS® interface	● FG-AC-MBS1Z1									● FG-RC-MBS1Z1 ● FG-AC-MBS1Z1		● FG-RC-MBS1Z1 ● FG-AC-MBS1Z1						● FG-AC-MBS1Z1		● FG-RC-MBS1Z1 ● FG-AC-MBS1Z1		● FG-AC-MBS1Z1		● FG-AC-MBS1Z1				● FG-RC-MBS1Z1 ● FG-AC-MBS1Z1
Interfacing	IR type	● FG-IR-BMG1Z1									● FG-IR-BMG1Z1+ ● UTY-LBTGC		● FG-IR-BMG1Z1+ ● UTY-LBTGM						● FG-IR-BMG1Z1+ ● UTY-LRHGM		● FG-IR-BMG1Z1 ● FG-IR-BMG1Z1+ ● UTY-LBTGH		● FG-IR-BMG1Z1				● FG-IR-BMG1Z1+ ● UTY-LBTGM		
	KNX® converter	● UTY-VKSX									● UTY-VKSX		● UTY-VKSX						● UTY-VKSX		● UTY-VKSX*2		● UTY-VKSX		● UTY-VKSX*1				● UTY-VKSX
Interfacing	KNX® interface	● FG-AC-KNX1Z1									● FG-RC-KNX1Z1 ● FG-AC-KNX1Z1		● FG-RC-KNX1Z1 ● FG-AC-KNX1Z1						● FG-AC-KNX1Z1		● FG-RC-KNX1Z1 ● FG-AC-KNX1Z1		● FG-AC-KNX1Z1		● FG-AC-KNX1Z1				● FG-RC-KNX1Z1 ● FG-AC-KNX1Z1
	IR type	● FG-IR-KNX1Z1									● FG-IR-KNX1Z1+ ● UTY-LBTGC		● FG-IR-KNX1Z1+ ● UTY-LBTGM						● FG-AC-KNX1Z1+ ● UTY-LBTGM		● FG-IR-KNX1Z1+ ● UTY-LRHGM		● FG-IR-KNX1Z1 ● FG-IR-KNX1Z1+ ● UTY-LBTGH		● FG-IR-KNX1Z1				● FG-IR-KNX1Z1+ ● UTY-LBTGM
Interfacing	3-wire RC-line type ¹ CN connector type										● UTY-TFSX13 ● UTY-TFSXZ1		● UTY-TFSX13 ● UTY-TFSXZ1						● UTY-TFNXZ1		● UTY-TFSX13 ● UTY-TFSXZ1						● UTY-TFSX13 ● UTY-TFSXZ1		
	USB type ¹	● Accessory (KGTG, KGTG, KETF, KETF-B, KMCG, KMCF) ● UTY-TFSXH3, UTY-TFSXF2 (KGTG, KETE, KETE-B, KMCE)									● UTY-TFSXH3 ● UTY-TFSXF2		● Accessory						● UTY-TFSXH3 ● UTY-TFSXF2				● Accessory				● UTY-TFSXH3 ● UTY-TFSXF2		
WLAN adapter	3-wire RC-line type CN connector type	● FG-AC-WIF1Z1									● FG-RC-WIF1Z2 ● FG-AC-WIF1Z1		● FG-RC-WIF1Z2 ● FG-AC-WIF1Z1						● FG-AC-WIF1Z1		● FG-RC-WIF1Z2 ● FG-AC-WIF1Z1		● FG-AC-WIF1Z1		● FG-AC-WIF1Z1				● FG-RC-WIF1Z2 ● FG-AC-WIF1Z1
	IR type	● FG-IR-WIF1Z1									● FG-IR-WIF1Z1+ ● UTY-LBTGC		● FG-IR-WIF1Z1+ ● UTY-LBTGM						● FG-IR-WIF1Z1+ ● UTY-LRHGM		● FG-IR-WIF1Z1 ● FG-IR-WIF1Z1+ ● UTY-LBTGH		● FG-IR-WIF1Z1				● FG-IR-WIF1Z1+ ● UTY-LBTGM		
WLAN adapter	3-wire RC-line type CN connector type	● FG-AC-WMP1Z1									● FG-RC-WMP1Z1 ● FG-AC-WMP1Z1		● FG-RC-WMP1Z1 ● FG-AC-WMP1Z1						● FG-AC-WMP1Z1		● FG-RC-WMP1Z1 ● FG-AC-WMP1Z1		● FG-AC-WMP1Z1		● FG-AC-WMP1Z1				● FG-RC-WMP1Z1 ● FG-AC-WMP1Z1
	IR type	● FG-IR-WMP1Z1									● FG-IR-WMP1Z1+ ● UTY-LBTGC		● FG-IR-WMP1Z1+ ● UTY-LBTGM						● FG-IR-WMP1Z1+ ● UTY-LRHGM		● FG-IR-WMP1Z1 ● FG-IR-WMP1Z1+ ● UTY-LBTGH		● FG-IR-WMP1Z1				● FG-IR-WMP1Z1+ ● UTY-LBTGM		
External switch controller		● UTY-TERX+UTY-TWRXZ2									● UTY-TERX		● UTY-TERX						● UTY-TERX+ ● UTY-TWRXZ3		● UTY-TERX		● UTY-TERX+ ● UTY-TWRXZ2				● UTY-TERX		
Network converter for single-split type	DC power supply type AC power supply type	● UTY-VTGX+UTY-TWRXZ2 ● UTY-VTGXV+UTY-TWRXZ2									● UTY-VTGX ● UTY-VTGXV		● UTY-VTGX ● UTY-VTGXV						● UTY-VTGX+ ● UTY-TWRXZ3 ● UTY-VTGXV+ ● UTY-TWRXZ3		● UTY-VTGX ● UTY-VTGXV		● UTY-VTGX+ ● UTY-TWRXZ2 ● UTY-VTGXV+ ● UTY-TWRXZ2				● UTY-VTGX ● UTY-VTGXV		

*1: Available only when the WLAN adapter (UY-TFSXF2) is removed. *2: Available only when the WLAN adapter (UTY-TFSXZ1) is removed.
*3: For compatibility of the new WLAN adapters with the indoor units which are not listed in this catalogue, please refer to page C-021.

Controller system list (available) for VRF

Controller Options:



Type	Refrigerant	Indoor unit											Indoor unit											
		Cassette		Slim type		Large type		Duct			Duct			Floor		Ceiling/Floor		Ceiling		Wall-mounted				
		One-way flow	3D flow	Compact Grid type/Standard type		Circular flow		Mini (With drain pump)	Low static pressure duct			Low static pressure duct High Efficiency	Medium static pressure Normal	High static pressure Normal	-	external EEV	Ceiling/Floor	Ceiling	-	external EEV	-	external EEV	-	-
				Grid type	High Efficiency	High Efficiency	Slim (With drain pump)		High Efficiency	High Efficiency	High Efficiency													
R32		AUXB 004/005/007/009/012/014/018/HLAH	AUXN 009/012/014/HLAH						ARXD 004/005/007/009/012/014/018/024/HLAH	ARXP 009/012/014/HLAH						ABHA 004/005/007/009/012/014/HCAH	ASHE 004/005/007/009/012/014/HCAH							
R410A		AUXV 004/007/009/012/014/018/024/GLEH	AUXS 018/024/GLEH	AUXB 004/007/009/012/014/018/024/GLEH	AUXM 018/024/030/034/036/045/054/GLEH	AUXK 018/024/030/034/036/045/054/GLEH	ARXK 004/007/009/012/014/018/024/GLGH	ARXD 04GALH	ARXD 007/009/012/014/018/024/GLEH	ARXP 018/030/GLFH	ARXA 024/030/036/045/GLEH	ARXC 036/045/060/072/090/096/GTEH	AGHA 004/007/009/012/014/GCGH	AGHE 004/007/009/012/014/GCEH	ABHA 012/014/018/024/GTEH	ABHA 030/036/045/054/GTEH	ASHA 004/007/009/GCGH	ASHE 004/007/009/GCEH	ASHA 012/014/GCGH	ASHE 012/014/GCEH	ASHA 18/24/GBCH	ASHA 030/034/GTEH		
Interfaces		UTY-ABGXZ1, UTY-VBGX																						
		FG-AC-BAC1Z1											FG-AC-BAC1Z1											
BACnet gateway		FG-AC-BAC1Z1											FG-AC-BAC1Z1											
		FG-IR-BMG1Z1+ UTY-TRHX	FG-IR-BMG1Z1	FG-IR-BMG1Z1+ UTY-LBHDX	FG-IR-BMG1Z1+ UTY-TRHX	FG-IR-BMG1Z1+ UTY-TRHX	FG-IR-BMG1Z1+ UTY-TRHX	FG-IR-BMG1Z1+ UTY-TRHX	FG-IR-BMG1Z1+ UTY-TRHX	FG-IR-BMG1Z1+ UTY-TRHX	FG-IR-BMG1Z1+ UTY-TRHX	FG-IR-BMG1Z1+ UTY-TRHX	FG-IR-BMG1Z1+ UTY-TRHX	FG-IR-BMG1Z1+ UTY-TRHX	FG-IR-BMG1Z1+ UTY-TRHX	FG-IR-BMG1Z1+ UTY-TRHX	FG-IR-BMG1Z1+ UTY-TRHX	FG-IR-BMG1Z1+ UTY-TRHX	FG-IR-BMG1Z1+ UTY-TRHX	FG-IR-BMG1Z1+ UTY-TRHX	FG-IR-BMG1Z1+ UTY-TRHX	FG-IR-BMG1Z1+ UTY-TRHX	FG-IR-BMG1Z1+ UTY-TRHX	FG-IR-BMG1Z1+ UTY-TRHX
Network converter for LonWorks™		UTY-VLGX											UTY-VLGX											
MODBUS Converter		UTY-VMSX											UTY-VMSX											
		UTY-VMGX FG-TL-MBS16Z1											UTY-VMGX FG-TL-MBS16Z1											
MODBUS interface		FG-AC-MBS1Z1											FG-AC-MBS1Z1											
		FG-IR-BMG1Z1+ UTY-TRHX	FG-IR-BMG1Z1	FG-IR-BMG1Z1+ UTY-LBHDX	FG-IR-BMG1Z1+ UTY-TRHX	FG-IR-BMG1Z1+ UTY-TRHX	FG-IR-BMG1Z1+ UTY-TRHX	FG-IR-BMG1Z1+ UTY-TRHX	FG-IR-BMG1Z1+ UTY-TRHX	FG-IR-BMG1Z1+ UTY-TRHX	FG-IR-BMG1Z1+ UTY-TRHX	FG-IR-BMG1Z1+ UTY-TRHX	FG-IR-BMG1Z1+ UTY-TRHX	FG-IR-BMG1Z1+ UTY-TRHX	FG-IR-BMG1Z1+ UTY-TRHX	FG-IR-BMG1Z1+ UTY-TRHX	FG-IR-BMG1Z1+ UTY-TRHX	FG-IR-BMG1Z1+ UTY-TRHX	FG-IR-BMG1Z1+ UTY-TRHX	FG-IR-BMG1Z1+ UTY-TRHX	FG-IR-BMG1Z1+ UTY-TRHX	FG-IR-BMG1Z1+ UTY-TRHX	FG-IR-BMG1Z1+ UTY-TRHX	
KNX converter		UTY-VKSX											UTY-VKSX											
		UTY-VKGX FG-TL-KNX16Z1											UTY-VKGX FG-TL-KNX16Z1											
KNX interface		FG-AC-KNX1Z1											FG-AC-KNX1Z1											
		FG-IR-KNX1Z1+ UTY-TRHX	FG-IR-KNX1Z1	FG-IR-KNX1Z1+ UTY-LBHDX	FG-IR-KNX1Z1+ UTY-TRHX	FG-IR-KNX1Z1+ UTY-TRHX	FG-IR-KNX1Z1+ UTY-TRHX	FG-IR-KNX1Z1+ UTY-TRHX	FG-IR-KNX1Z1+ UTY-TRHX	FG-IR-KNX1Z1+ UTY-TRHX	FG-IR-KNX1Z1+ UTY-TRHX	FG-IR-KNX1Z1+ UTY-TRHX	FG-IR-KNX1Z1+ UTY-TRHX	FG-IR-KNX1Z1+ UTY-TRHX	FG-IR-KNX1Z1+ UTY-TRHX	FG-IR-KNX1Z1+ UTY-TRHX	FG-IR-KNX1Z1+ UTY-TRHX	FG-IR-KNX1Z1+ UTY-TRHX	FG-IR-KNX1Z1+ UTY-TRHX	FG-IR-KNX1Z1+ UTY-TRHX	FG-IR-KNX1Z1+ UTY-TRHX	FG-IR-KNX1Z1+ UTY-TRHX	FG-IR-KNX1Z1+ UTY-TRHX	
WLAN adapter		UTY-TFSXJ3 UTY-TFSXZ1											UTY-TFSXJ3 UTY-TFSXZ1											
		FG-AC-WIF1Z1											FG-AC-WIF1Z1											
		FG-IR-WIF1Z1+ UTY-TRHX	FG-IR-WIF1Z1	FG-IR-WIF1Z1+ UTY-LBHDX	FG-IR-WIF1Z1+ UTY-TRHX	FG-IR-WIF1Z1+ UTY-TRHX	FG-IR-WIF1Z1+ UTY-TRHX	FG-IR-WIF1Z1+ UTY-TRHX	FG-IR-WIF1Z1+ UTY-TRHX	FG-IR-WIF1Z1+ UTY-TRHX	FG-IR-WIF1Z1+ UTY-TRHX	FG-IR-WIF1Z1+ UTY-TRHX	FG-IR-WIF1Z1+ UTY-TRHX	FG-IR-WIF1Z1+ UTY-TRHX	FG-IR-WIF1Z1+ UTY-TRHX	FG-IR-WIF1Z1+ UTY-TRHX	FG-IR-WIF1Z1+ UTY-TRHX	FG-IR-WIF1Z1+ UTY-TRHX	FG-IR-WIF1Z1+ UTY-TRHX	FG-IR-WIF1Z1+ UTY-TRHX	FG-IR-WIF1Z1+ UTY-TRHX	FG-IR-WIF1Z1+ UTY-TRHX	FG-IR-WIF1Z1+ UTY-TRHX	
		FG-AC-WMP1Z1											FG-AC-WMP1Z1											
		FG-IR-WMP1Z1+ UTY-TRHX	FG-IR-WMP1Z1	FG-IR-WMP1Z1+ UTY-LBHDX	FG-IR-WMP1Z1+ UTY-TRHX	FG-IR-WMP1Z1+ UTY-TRHX	FG-IR-WMP1Z1+ UTY-TRHX	FG-IR-WMP1Z1+ UTY-TRHX	FG-IR-WMP1Z1+ UTY-TRHX	FG-IR-WMP1Z1+ UTY-TRHX	FG-IR-WMP1Z1+ UTY-TRHX	FG-IR-WMP1Z1+ UTY-TRHX	FG-IR-WMP1Z1+ UTY-TRHX	FG-IR-WMP1Z1+ UTY-TRHX	FG-IR-WMP1Z1+ UTY-TRHX	FG-IR-WMP1Z1+ UTY-TRHX	FG-IR-WMP1Z1+ UTY-TRHX	FG-IR-WMP1Z1+ UTY-TRHX	FG-IR-WMP1Z1+ UTY-TRHX	FG-IR-WMP1Z1+ UTY-TRHX	FG-IR-WMP1Z1+ UTY-TRHX	FG-IR-WMP1Z1+ UTY-TRHX	FG-IR-WMP1Z1+ UTY-TRHX	
External switch controller		UTY-TERX											UTY-TERX											

*1: For compatibility of the new WLAN adapters with the indoor units which are not listed in this catalogue, please refer to page C-021.

Optional parts Overview

For Split & Multi-split, VRF

A variety of optional parts are available to enable installation of the selected indoor unit properly according to the environment.

Optional Parts For Cassette



Human sensor kit
A built-in thermo sensor monitors and controls room temperature accurately.



Cassette grille
A lineup of cassette grilles that match a variety of interiors. A grid ceiling-type cassette grille has been added to the lineup.



Silver ion filter
The Silver ion filter helps to keep indoor air free from viruses, bacteria and molds.*



Fresh air intake kit
Fresh air can be taken in by a fan connected to an external control unit.

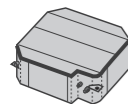

Insulation kit for high humidity
Insulation kit for high humidity is used when the installation location is in a high humidity environment.

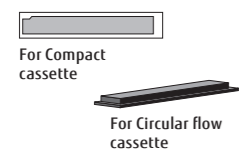

Air outlet shutter plate
Airflow directions can be changed to 3 directions using the Air outlet shutter plate depending on the installation location.

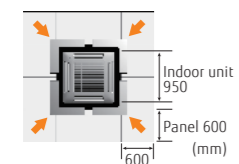

Wide Panel
When a cassette type is installed in a narrow space in the ceiling, the wide panel fills in that space.

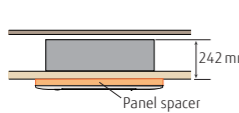

Panel spacer
If the ceiling space is tight and the main body protrudes from the ceiling surface, a panel spacer can be used as a decorative trim.

Optional Parts For V-IV



Pressure sensor kit
When installed, the height difference between the outdoor unit and indoor unit can be allowed up to 110 m.

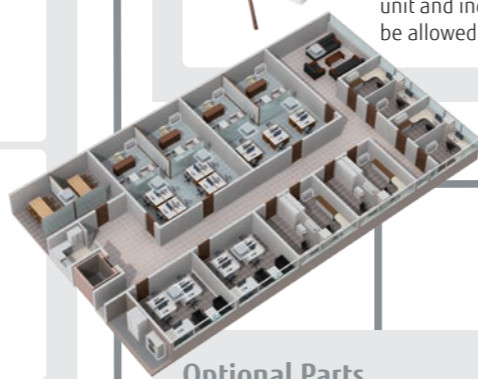

Optional Parts For R32 VRF products



Gas Sensor kit
Used to ensure standards compliance and safety when R32 VRF products are installed.



Expansion kit
Connect to indoor units to expand the number of inputs and outputs when using multiple safety devices or external input/output functions.

Optional Parts For Floor

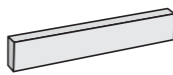

Half concealed kit
Used to half conceal a floor type indoor unit in the wall.



Silver ion filter
The Silver ion filter helps to keep indoor air free from viruses, bacteria and molds.*

Optional Parts For Duct & Ceiling



Auto louver grille kit
The optional clean-looking flat Auto louver grille blends into any interior and provides a comfortable airflow.



Remote sensor unit
The remote sensor provides additional convenience.

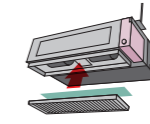
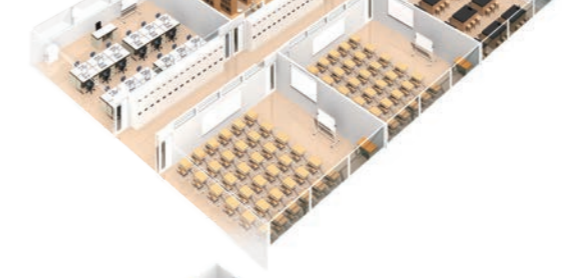

Silver ion filter
The Silver ion filter helps to keep indoor air free from viruses, bacteria and molds.*



Long-life filter
Captures grit and dust. Long-life design with consideration of running costs.

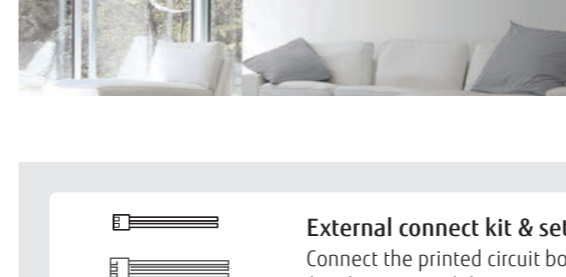

Flange
Flanges are used when connecting a medium static pressure duct type and a ceiling type with air intake and exhaust ducts.

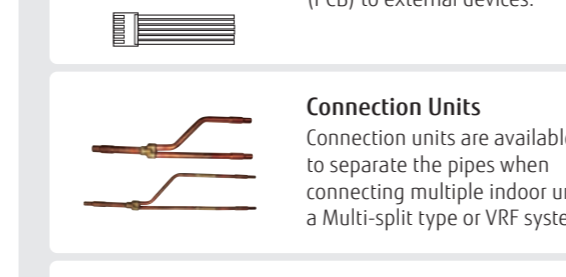

Drain pump unit
Drains water that has accumulated during operation.

Connection Parts

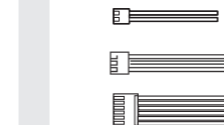

External connect kit & set
Connect the printed circuit board (PCB) to external devices.



Connection Units
Connection units are available to separate the pipes when connecting multiple indoor units in a Multi-split type or VRF system.



External power supply unit
The External power supply unit protects the increment in the system even if the power supply for some of the indoor units is shut down.



Communication kit
Required for a wall-mounted type when the External connect kit set or a Wired remote controller is connected to the indoor unit.



External input and output PCB
For Wall-mounted, Duct, or Cassette type, these parts are required when the external input and output function is used.



External input and output PCB box & bracket
Box and bracket for installing the External input and output PCB.

*Not a result of experiments in an actual use environment. Silver ion filter inhibits activity or growth of microorganism, but do not prevent infection.

Silver Ion Filter

UTR-FA16-5 / UTR-FA13-3 / UTR-FA03-5 / UTD-HFAA / UTD-HFRA / UTD-HFTA / UTD-HFTB / UTD-HFTC / UTD-HFNC / UTD-HFNB / UTD-HFNA / UTD-HFND / UTD-HFKB / UTD-HFKA



For Wall mounted / Floor
UTR-FA16-5 / UTR-FA13-3
UTR-FA03-5

For Cassette
UTD-HFAA / UTD-HFRA

For Duct
UTD-HFTA / UTD-HFTB
UTD-HFTC / UTD-HFNC
UTD-HFNB / UTD-HFNA
UTD-HFND / UTD-HFKB
UTD-HFKA

The Silver ion filter helps to keep indoor air free from viruses, bacteria and molds.

(Not a result of experiments in an actual use environment. Silver ion filter inhibits activity or growth of microorganism, but do not prevent infection.)

The silver ion filter inhibits the activities of viruses*1, bacteria*2 and molds*3 trapped on the filter.

(Only effective when the microorganism is trapped on the filter with dust or droplet)

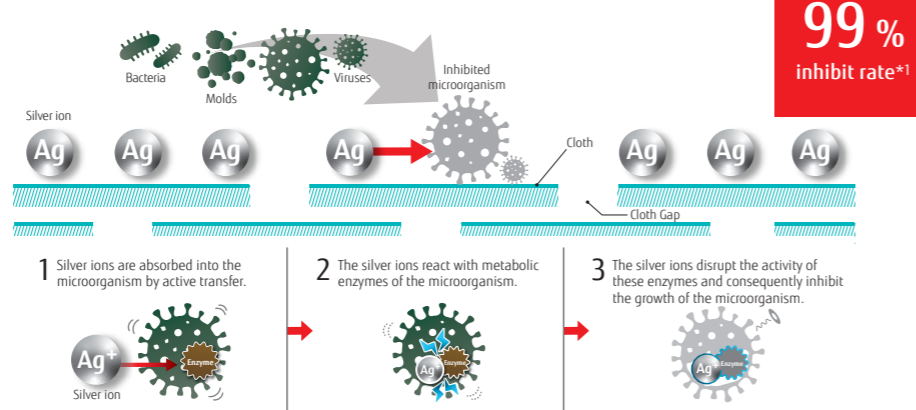

*1 [Testing organization] Kitasato Research Center for Environmental Science [Test Report] No. 2020_0408 [Test virus] Escherichia coli phage Qbeta NBRC 20012 (1 type) [Test Method] Based on the antiviral test method for textile products (JIS L 1922) [Test results] Inhibited by at least 99% in 24 hours. Not tested to prevent transmission of SARS-CoV-2.
*2 [Testing organization] Kitasato Research Center for Environmental Science [Test Report] No. 2020_0409 [Test bacteria] Escherichia coli NBRC 3972 (1 type) [Test Method] Based on the determination of antibacterial activity and efficacy of textile products (JIS L 1902) [Test results] The growth of the test bacteria was inhibited by 24 hours testing
*3 [Testing organization] Kitasato Research Center for Environmental Science [Test Report] No. 2020_0410 [Test fungi] Aspergillus Niger NBRC 105649 and other fungi (3 types) [Test Method] Based on the test for fungus resistance (JIS Z 2911) [Test results] The growth of the fungus was inhibited by 28 days testing

The filter is easily removable* and hand-washable.

(*Wall mounted and floor models only)



*4 Hand-washing or vacuuming by 3 months is recommended. Cleaning frequency varies depending on the environment of use.

Specifications

Model name	For Wall mounted / Floor			for Cassette		
	UTR-FA16-5	UTR-FA13-3	UTR-FA03-5	UTD-HFAA	UTD-HFRA	
Net Dimension (H x W x D)	mm	35 x 210 x 6	50 x 364 x 6	43 x 272 x 6	350 x 125 x 6	550 x 136 x 6
Weight	g	2	2	2	7	23
Quantity		2	2	2	1	1

Model name	for Duct									
	UTD-HFTA	UTD-HFTB	UTD-HFTC	UTD-HFNC	UTD-HFNB	UTD-HFNA	UTD-HFND	UTD-HFKB	UTD-HFKA	
Net Dimension (H x W x D)	mm	290 x 70 x 6	390 x 70 x 6	290 x 70 x 6 390 x 70 x 6	620 x 88 x 6	420 x 88 x 6	620 x 88 x 6	500 x 79 x 6	420 x 125 x 6	620 x 108 x 6
Weight	g	6	8	10	8	10	16	12	16	20
Quantity		2	2	3	1	2	2	2	2	2

Auto louver grille kit

UTD-GXTA-W / UTD-GXTB-W / UTD-GXTC-W



The optional clean-looking flat Auto louver grille kit blends into any interior and provides a comfortable airflow.



Flexible Control

- The Auto louver grille of the indoor unit can be operated in conjunction with the remote control of the indoor unit.
- Vertical auto swing**
 - Auto airflow direction and auto swing
 - 4 steps selectable
- Auto-closing louver**
 - The louvers will automatically close when the indoor unit stops operating.

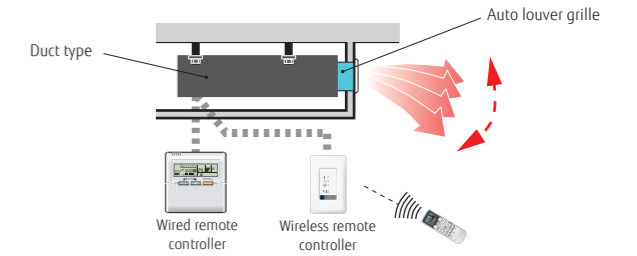

Dimensions

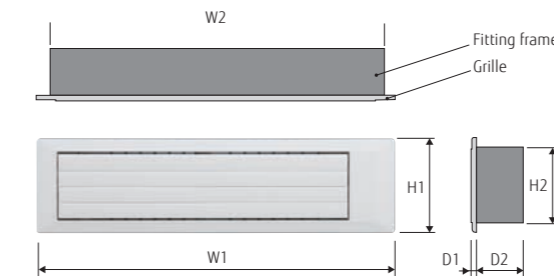

Model name	W1	W2	H1	H2	D1	D2
UTD-GXTA-W	683	645				
UTD-GXTB-W	883	845	180	148	9	84
UTD-GXTC-W	1,083	1,045				

Unit: mm

Specifications

Model name	UTD-GXTA-W		UTD-GXTB-W		UTD-GXTC-W		
Applicable indoor unit	SPLIT & MULTI-SPLIT ARHG07/09LLTA ARXG07/09/12/14KSLAP ARXG07/09/12/14KLLAP ARHG07/09LSLAP		ARXG18KSLAP ARXG18KLLAP		ARXD018GLEH ARXD018HLAH ARXK018GLGH		
	VRF ARXD007/009/012/014GLEH ARXK004/007/009/012/014GLGH ARXD04GALH ARXD004/005/007/009/012/014HLAH ARXP009/012/014HLAH		ARXD018GLEH ARXD018HLAH ARXK018GLGH		ARXD024GLEH ARXD024HLAH ARXK024GLGH		
Power supply	Connecting with Control box of indoor unit						
Fixing Auto louver grille	Screwed to Flange or Square duct						
Extension Square duct limit	1.0 m (Max. duct length between indoor unit and Auto louver grille)						
Net Dimensions (H x W x D)	mm	180 x 683 x (84 + 9)		180 x 883 x (84 + 9)		180 x 1,083 x (84 + 9)	
Weight	Net	kg (lbs)	2.0 (4.4)		2.5 (5.6)		3.0 (6.7)
Accessories	Fitting Flame, etc.						
Operating range	Cooling	°C	18 to 32				
		% RH	80 % or less				
Operating range	Heating	°C	16 to 30				

Pressure sensor kit

UTY-SPWX



Design flexibility

The height difference between the outdoor unit and the indoor unit is normally 50 m for the V-IV Series, but can be extended to 110 m by installing the Pressure sensor kit. (Can only be connected to the V-IV Series. Also, it can only be connected to outdoor units using outdoor unit software compatible with the product.)

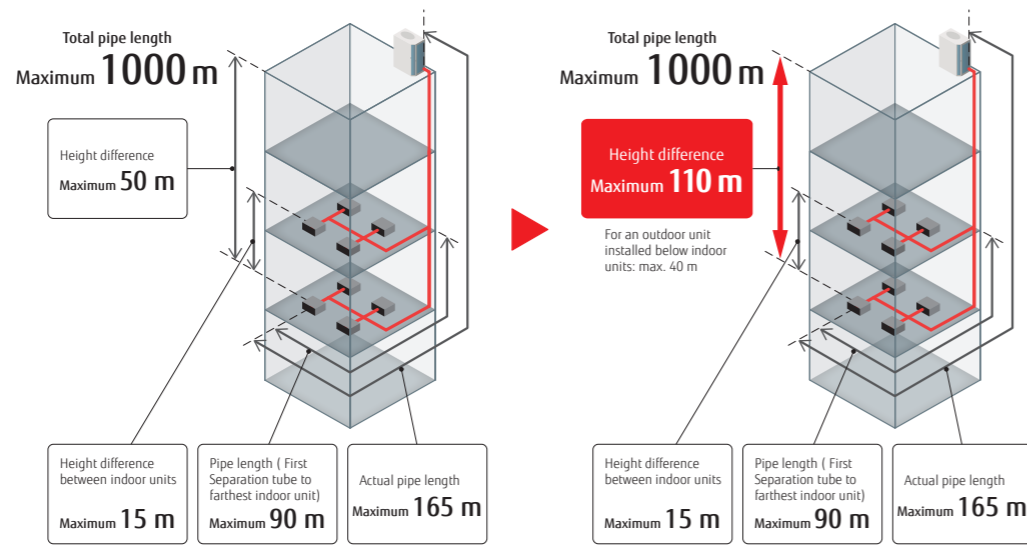

System overview

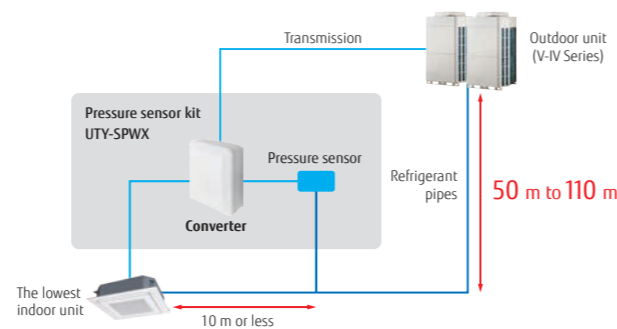

Pressure sensor kit

Pressure sensor kit (Converter)	Refrigerant pressure sensor	Joint pipe

Specifications

Model name	UTY-SPWX
Power supply	9 to 16 V DC
Dimensions (H × W × D) (mm)	140 × 117 × 43
Weight (g)	200

External power supply unit

UTZ-GXXA / UTZ-GXXC / UTZ-GXXD



The External power supply unit protects the increment in the system even if the power supply for some of the indoor units is shut down.

Connects to the External power supply unit to supply power to the indoor unit from the auxiliary power supply. This allows for continuous operation without system errors. Built-in relays reduce installation time and cost. The UTZ-GXXC and UTZ-GXXD have a built-in relay, which reduces installation time and cost.

High reliability

- A: Interruption of the main power supply is detected by the power cut-off detection part.
- B: Supplies power for driving the expansion valve of the indoor unit. (12 V or 5 V DC)
- C: Gives notification of the power supply from the External power supply unit.

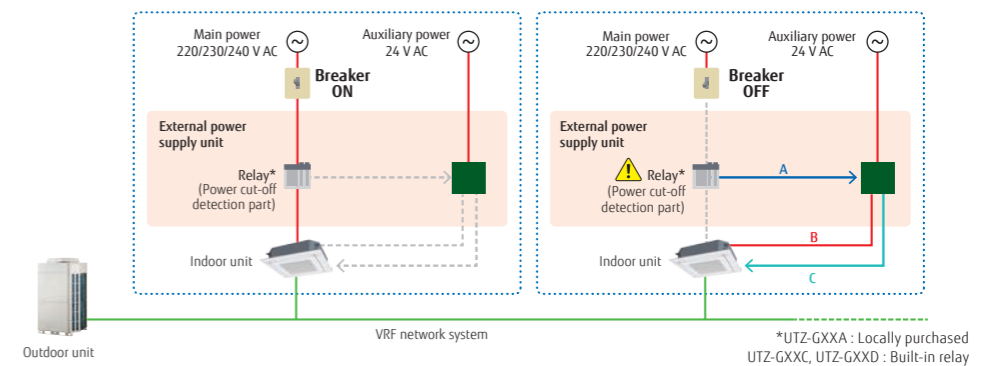

Note

- When changing the power supply voltage to 24 V AC, use a power transformer with an insulated structure that complies with the regulations* of the installation region.
- A powered-off indoor unit driven by the External power supply unit is treated in the same way as an operation-off unit in the electricity charge appointment function. If standby power is generated, the result of the electricity charge appointment may not be zero.

*UL Class II or IEC 61558 Class III, for example.

Specifications

Model name	UTZ-GXXA	UTZ-GXXC	UTZ-GXXD
Power supply		24 V AC 50/60 Hz	
Dimensions (H × W × D) (mm)		97 × 200 × 178	
Weight (g)		800	

AIR BEAM Radiation air outlet unit

*Production by order
Contact us for more details.



Key component

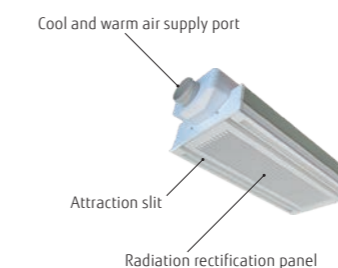

Cross-section view

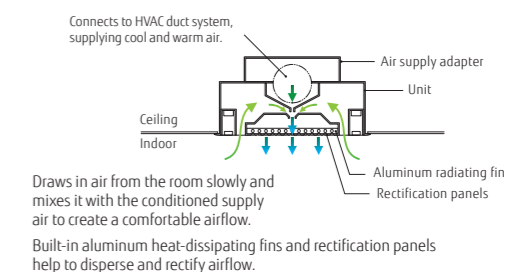

Airflow rate (m ³ /h)	180 (160-215)	270 (240-325)
Grid	600 × 2	600 × 3
AIR BEAM For system ceiling (Integrated type)	KS-180	KS-270

Gas sensor kit

UTY-SGZH



NEW



Enhanced disaster safety measures

The system is designed to meet the environmental safety requirements specified in the IEC 603352-40 standard for the use of R32 refrigerant. The environment requiring safety measures is determined by the size of the room in relation to the amount of refrigerant required.

For example, if the system is designed for maximum pipe length and the refrigerant charge is 6 kg, safety measures are required for rooms of 15 m² or less.

For Example: Total pipe length 120m

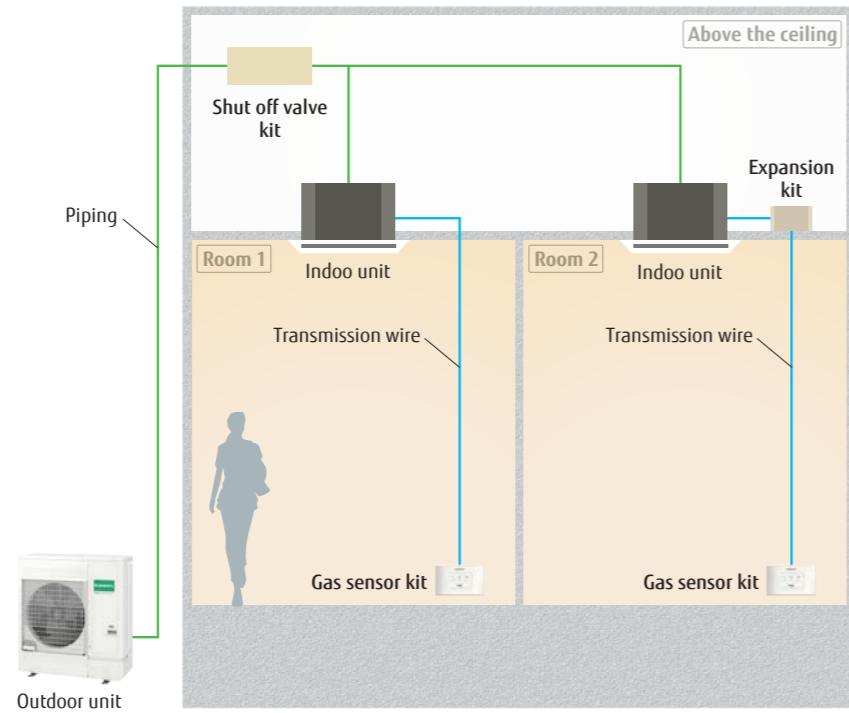

Shut off valve kit
UTP-GX027A, UTP-GX060A

Block the path to prevent refrigerant flow in the event of a refrigerant leakage.

Expansion kit
UTZ-JXXA*

Used to ensure standards compliance and safety when R32 VRF products are installed.
*Connection cable (UTY-XWZXZL) is required.

Gas sensor kit
UTY-SGZH

Gas Sensor kit Used to ensure standards compliance and safety when R32 VRF products are installed.

Conditions requiring safety measures

The graph below will help you determine if a safety design is required when installing R32 VRF products. The amount of refrigerant in a refrigerant system determines the floor area, and if the room to be conditioned by the system is less than that area, a "shut off valve kit" and a "gas sensor kit" must be installed.

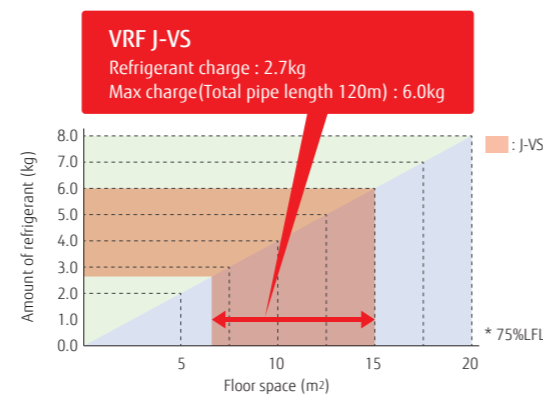

Features: Gas sensor kit

Refrigerant leak detector connection pattern

1) Corresponds to the case where the classification of air conditioner installation differs from property to property.

Installation position of "Shut off valve kit"

- A** Indoor unit 1~4 in one room
- B** Indoor units 1, 2 and 3, 4, if they are set up in two separate rooms.
- C** Indoor units 1~4 are installed in different rooms.

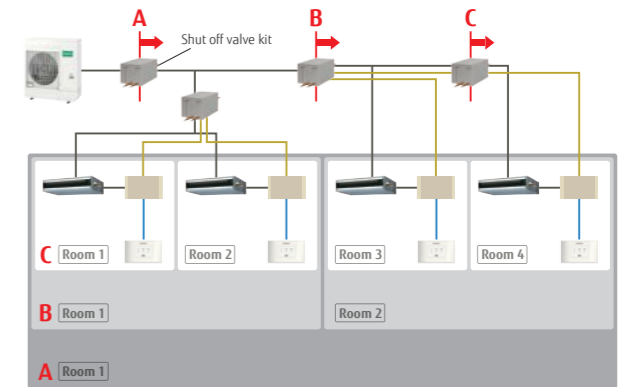

2) Multiple rooms or areas are air conditioned using ducted airflow paths

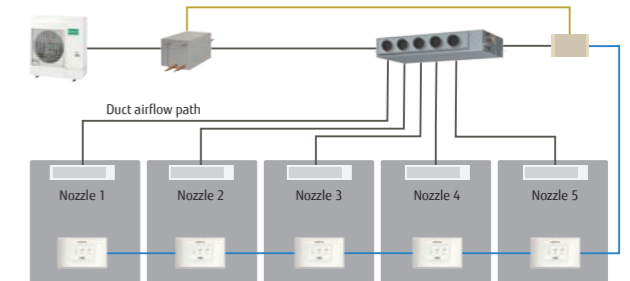

3) When operating multiple indoor units with a remote control group

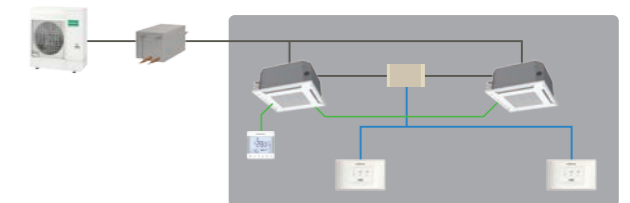

Specifications

Model name	UTY-SGZH
Dimensions (H × W × D) (mm)	80 × 130 × 35
Weight (g)	500

Optional parts list for VRF





Type	Refrigerant	Indoor unit												Indoor unit										V-IV Series		
		Cassette						Duct						Floor				Wall-mounted								
		One-way flow	3D flow	Compact grid type/ Standard type		Slim type	Large type	Low static pressure duct						external EEV	Floor/Ceiling	Ceiling	Wall-mounted									
				High Efficiency	Circular flow	Mini (With drain pump)	Slim (With drain pump)		High Efficiency	Low static pressure duct	Medium static pressure	High static pressure	external EEV				external EEV	external EEV	external EEV							
		AUXB 004/005/007/ 009/012/014/ 018HLAH	AUXN 009/012/014 HLAH				ARXD 004/005/007/ 009/012/014/ 018/024 HLAH	ARXP 009/012/014 HLAH	ARXP 018/030 GLFH	ARXA 024/030/ 036/045 GLEH	ARXC 036/045/060 GTEH	ARXC 072/090/096 GTEH	AGHA 004/007/ 009/012/014 GCGH	AGHE 004/007/ 009/012/014 GCEH	ABHA 012/014/ 018/024 GTEH	ABHA 030/036/ 045/054 GTEH	ASHA 004/007/009 012/014 GCGH	ASHE 004/007/009 012/014 GCEH	ASHA 18/24GBCH	ASHA 030/034GTEH	AJH 072/090/108/ 126/144/162 LALDH					
Human sensor kit																										
Remote sensor unit																										
Cassette grille																										
Auto louver grille kit																										
Silver ion filter																										
Long-life filter																										
Flange																										
Drain Pump Unit																										
Wide Panel																										
Panel spacer																										
Fresh air intake kit*1																										
Air outlet shutter plate:																										
Insulation kit for high humidity																										
Half concealed kit																										
External power supply unit																										
Pressure sensor kit																										
Gas sensor kit																										



















Separation tube













For SPLIT/MULTI-SPLIT/SIMULTANEOUS MULTI-SPLIT

<p>Separation tube</p> <p>UTP-SX236A / UTP-SX254A For 3-phase simultaneous multi-split</p> <p>UTP-SX272A For Simultaneous multi-split Twin/Triple/Double Twin</p> 	<p>UTP-SX354A For 3-phase simultaneous multi-split</p> <p>UTP-SX372A For Simultaneous multi-split Twin/Triple/Double Twin</p> 
---	---

for VRF

<p>Separation tube</p> <p>UTP-AX054A</p> <p>Gas pipe</p>  <p>Liquid pipe</p> 	<p>UTP-AX090A</p> <p>Gas pipe</p>  <p>Liquid pipe</p> 	<p>UTP-AX180A</p> <p>Gas pipe</p>  <p>Liquid pipe</p> 	<p>UTP-AX567A</p> <p>Gas pipe</p>  <p>Liquid pipe</p> 
<p>UTP-BX090A</p> <p>Suction Gas pipe</p>  <p>Discharge Gas pipe</p>  <p>Liquid pipe</p> 	<p>UTP-BX180A</p> <p>Suction Gas pipe</p>  <p>Discharge Gas pipe</p>  <p>Liquid pipe</p> 	<p>UTP-BX567A</p> <p>Suction Gas pipe</p>  <p>Discharge Gas pipe</p>  <p>Liquid pipe</p> 	<p>UTP-LX180A For DX kit</p> 

Header

<p>UTR-H0906L / UTR-H1806L</p> <p>Gas pipe</p>  <p>Liquid pipe</p> 	<p>UTR-H0908L / UTR-H1808L</p> <p>Gas pipe</p>  <p>Liquid pipe</p> 	<p>UTP-J0906A / UTP-J1806A</p> <p>Suction gas pipe</p>  <p>Discharge gas pipe</p>  <p>Liquid pipe</p> 	<p>UTP-J0908A / UTP-J1808A</p> <p>Suction gas pipe</p>  <p>Discharge gas pipe</p>  <p>Liquid pipe</p> 
---	---	--	---

Outdoor unit branch kit

UTP-CX567A







Gas Pipe



Liquid Pipe

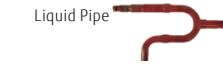
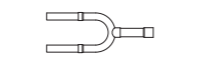

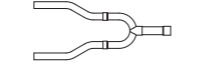

Separation tube for RB unit





<p>UTP-DX567A</p> <p>Suction Gas Pipe</p>  <p>Discharge Gas Pipe</p>  <p>Liquid Pipe</p> 	<p>UTP-EX060A</p> <p>Gas Pipe</p>  <p>Liquid Pipe</p> 	<p>UTP-EX096A</p> <p>Gas Pipe</p>  <p>Liquid Pipe</p> 
--	--	--



for VRF

<p>EV kit</p> <p>Model name \leq 09: UTR-EV09XB Model name \geq 12: UTR-EV14XB for compact wall-mounted type</p> 	<p>NEW Model name \leq 09: UTR-EV09XC Model name \leq 12: UTR-EV14XC for R32 VRF wall-mounted type</p> 	<p>NEW UTP-GX027A for R32 VRF indoor unit</p> 	<p>NEW UTP-GX060A for R32 VRF outdoor unit</p> 
--	---	--	---

RB unit

<p>UTP-RX01AH / UTP-RX01BH / UTP-RX01CH Single type</p> 	<p>UTP-RX04BH Multi-split type</p> 	<p>UTP-RX08AH Multi-split type</p> 	<p>UTP-RX12AH Multi-split type</p> 
---	--	--	--

Specifications

Separation tube

Model name	UTP-AX054A	UTP-AX090A	UTP-AX180A	UTP-AX567A
Total cooling capacity of indoor unit (kW)	19.6 or less	28.0 or less	28.1 to 56.0	56.1 or more
Model name	UTP-BX090A	UTP-BX180A	UTP-BX567A	
Total cooling capacity of indoor unit (kW)	28.0 or less	28.1 to 56.0	56.1 or more	

Header

Model name	3-6 Branches	UTR-H0906L	UTR-H1806L
	3-8 Branches	UTR-H0908L	UTR-H1808L
Total cooling capacity of indoor unit (kW)		28.0 or less	28.1 to 56.0
Model name	3-6 Branches	UTP-J0906A	UTP-J1806A
	3-8 Branches	UTP-J0908A	UTP-J1808A
Total cooling capacity of indoor unit (kW)		28.0 or less	28.1 to 56.0

Outdoor unit branch kit

Model name	UTP-CX567A (for V-IV)	UTP-DX567A (for VR-IV)
Number of outdoor units	2 outdoor units	1
	3 outdoor units	2

EV kit

Model name	UTR-EV09XB	UTR-EV14XB	UTR-EV09XC	UTR-EV14XC
Application model	ASHE004GCEH ASHE007GCEH ASHE009GCEH	AGHE004GCEH AGHE007GCEH AGHE009GCEH	ASHE012GCEH AGHE014GCEH	ASHE004HCAH ASHE005HCAH ASHE007HCAH ASHE009HCAH

RB unit

Type	Single type		Multi-split type			
Model name	UTP-RX01AH	UTP-RX01BH	UTP-RX01CH	UTP-RX04BH	UTP-RX08AH	UTP-RX12AH
Power source	230/1/50					
Input power	W					
	17	24	31	96	136	204
Number of branches						
	1	1	1	4	8	12
Maximum capacity of connectable indoor units (Q)	kW					
	$Q \leq 8.0$	$Q \leq 18.0$	$Q \leq 28.0$	$Q \leq 56.1^{*1}$	$Q \leq 72.0$	$Q \leq 95.0$
Maximum capacity of connectable indoor units per branch (Q)	kW					
	$Q \leq 8.0$	$Q \leq 18.0$	$Q \leq 28.0$	$Q \leq 18.0$	$Q \leq 8.0$	$Q \leq 8.0$
Maximum Connectable Indoor Units per Branch						
	3	8	8	8	7	7
Dimensions (H × W × D)	mm					
	198 × 298 × 268			260 × 658 × 428		298 × 660 × 618

*1: When two RB units are connected in series (8 branches in total), the maximum capacity of the connectable indoor units is up to 56.0 kW.

Shut off valve kit

Model name	UTP-GX027A		UTP-GX060A
Power source	230/1/50		
Input power	W		
	24		
Number of branches			
	1		
Maximum number of connectable Expansion kit	kW		
	4		
Maximum capacity of connectable indoor units (Q)	kW		
	$Q \leq 8.0$		
Maximum capacity of Connectable Indoor Units per Branch (Q)	kW		
	$Q \leq 8.0$		
Dimensions (H × W × D)	mm		
	250 × 540 × 267		

Residential AIR TO WATER

- W-002 AIR TO WATER Overview
- W-004 AIR TO WATER Lineup
- W-006 Benefits
- W-008 Home Heating & Domestic Hot Water Supply
- W-010 High-Efficiency Technology
- W-012 Split Type
 - Comfort Series
 - Super High Power Series
 - High Power Series
- W-018 Split DHW Integrated Type
 - Comfort Series
 - Super High Power Series
 - High Power Series
- W-024 Control Overview
- W-026 Comfort Control
- W-028 System Configuration
- W-030 Case Studies
- W-032 Simple installation
 - Easy Installation & Maintenance
- W-034 Installation requirements
- W-035 AIR TO WATER Optional Parts



AIR TO WATER
Residential



FUJITSU GENERAL LIMITED

AIR TO WATER Overview

Solutions that meet a variety of needs

Water heated by Air to water using clean energy is delivered reliably and comfortably throughout the house, including the living room.



Heat Pump System Framework

Heat is absorbed from the atmosphere by expanding the refrigerant. Higher-temperature heat is generated by compressing the refrigerant, and the indoor unit transfers that heat to the water.

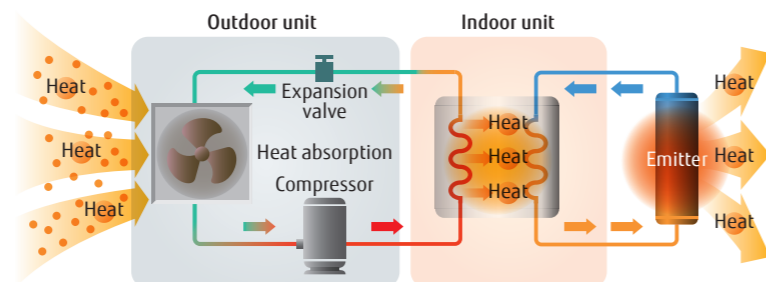

Our Goal

Decarbonisation

European Commission is committed to decarbonisation and has a national target of "Net Zero" carbon emissions by 2050.

We need to reduce carbon emissions with green technology products and increase carbon absorption by working to extend nature.

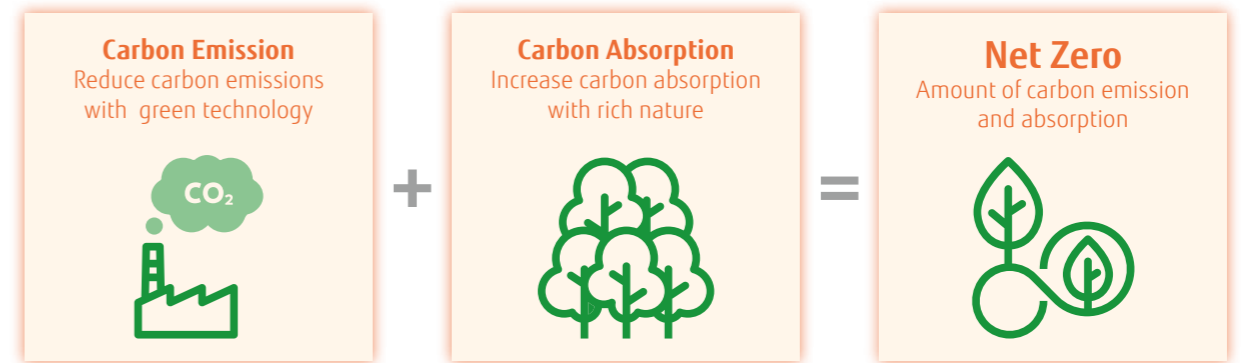

Fujitsu General's ATW system will provide the best solutions that are friendly to the environment and people with products conscious of decarbonisation.

The Choice of ATW

Optimized refrigerant cycle operation

Super High Power and High Power Series deliver high performance and efficiency with twin sensors and hot water heating technology.

Split Type

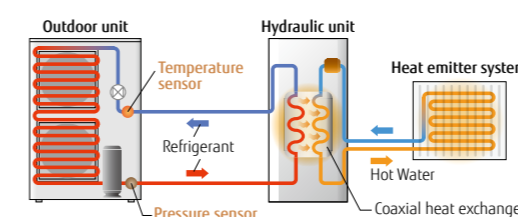

Split DHW Integrated Type

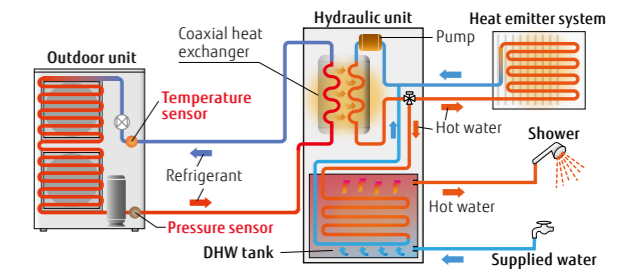

What is a heat pump?

A heat pump extracts heat energy from the atmosphere. It requires only 1 kWh of electricity to generate 3 to 5 kWh of thermal energy.

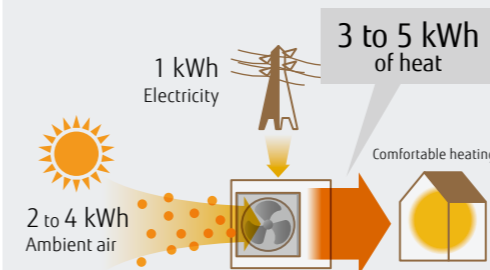

Primary energy usage reduced substantially

Proportion of primary energy converted into heating energy is 100%

Primary Energy Consumption*

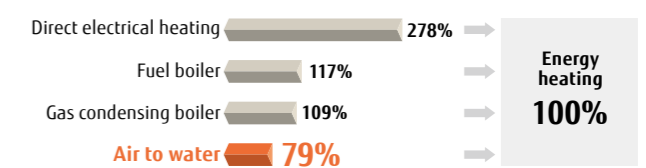

* The amount of electricity loss varies according to the power plant. Typical energy efficiency of a power plant: 36%

AIR TO WATER Lineup



Type	Split Type				Split DHW Integrated Type							
	Comfort Series		Super High Power Series		High Power Series		High Power Series					
Hydraulic unit												
Outdoor unit												
Capacity range	5/6 kW	8 kW	10 kW	16 kW	11/14 kW	11/14/16 kW	5/6 kW	8 kW	10 kW	16 kW	11/14 kW	11/14/16 kW
System outline	<ul style="list-style-type: none"> Supplies 55°C hot water even when the outdoor temperature is -10°C. Heating and DHW supply in one system.* Equipped with additional electric heater for backup Up to two independent control circuits.* Cooling operation is possible.* Operating range is -20 to 35°C. Can be used with a variety of heating systems, including underfloor heating and radiators.* 		<ul style="list-style-type: none"> Supplies 60°C hot water even when the outdoor temperature is -20°C. Supplies 55°C hot water even when the outdoor temperature is -22°C. Can be used with a variety of heating systems, including underfloor heating and radiators.* Heating and DHW supply in one system.* Equipped with additional electric heater for backup Up to two independent control circuits.* Cooling operation is possible.* Operating range is -25 to 35°C. 		<ul style="list-style-type: none"> Supplies 60°C hot water even when the outdoor temperature is -20°C. Can be used with a variety of heating systems, including underfloor heating and radiators.* Heating and DHW supply in one system.* Up to two independent control circuits.* Cascade connection is possible for up to three systems.* Cooling operation is possible.* Operating range is -25 to 35°C. 		<ul style="list-style-type: none"> Supplies 55°C hot water even when the outdoor temperature is -10°C. Heating and DHW supply in one system. Equipped with additional electric heater for backup Up to two independent control circuits.* Cooling operation is possible.* Operating range is -20 to 35°C. Can be used with a variety of heating systems, including underfloor heating and radiators.* 		<ul style="list-style-type: none"> Supplies 60°C hot water even when the outdoor temperature is -20°C. Supplies 55°C hot water even when the outdoor temperature is -22°C. Can be used with a variety of heating systems, including underfloor heating and radiators.* Space saving heating and DHW supply in a single Hydraulic unit Equipped with additional electric heater for backup Up to two independent control circuits.* Cooling operation is possible.* Operating range is -25 to 35°C. 		<ul style="list-style-type: none"> Supplies 60°C hot water even when the outdoor temperature is -20°C. Can be used with a variety of heating systems, including underfloor heating and radiators.* Space saving heating and DHW supply in a single Hydraulic unit Up to two independent control circuits.* Cooling operation is possible.* Operating range is -25 to 35°C. 	
Power source	Single phase, ~230 V, 50 Hz		Single phase, ~230 V, 50 Hz		Single phase, ~230 V, 50 Hz	3-phase, ~400 V, 50 Hz	Single phase, ~230 V, 50 Hz		Single phase, ~230 V, 50 Hz		Single phase, ~230 V, 50 Hz	3-phase, ~400 V, 50 Hz
Capacity	5 kW	WSHA050ML3 WOHA060KLT						WGHA050ML3 WOHA060KLT				
	6 kW	WSHA080ML3 WOHA060KLT						WGHA080ML3 WOHA060KLT				
	8 kW	WSHA080ML3 WOHA080KLT						WGHA080ML3 WOHA080KLT				
	10 kW	WSHA100ML3 WOHA100KLT						WGHA100ML3 WOHA100KLT				
	11 kW				WSHG140DG WOHG112LHT	WSHG140DG WOHK112LCTA					WGHG140DG WOHG112LHT	WGHG140DG WOHK112LCTA
	14 kW				WSHG140DG WOHG140LCTA	WSHG140DG WOHK140LCTA					WGHG140DG WOHG140LCTA	WGHG140DG WOHK140LCTA
	16 kW				WSHG160DJ6 WOHG160LJL	WSHG140DG WOHK160LCTA			WGHG160DJ6 WOHG160LJL			WGHG140DG WOHK160LCTA
	17 kW											
Approval												

* Please refer to page W-038 and W-039 for optional parts information.

Benefits

Less
CO₂ Emissions

Air to water is an environmentally friendly system that emits substantially less carbon dioxide than conventional gas and hydrocarbon combustion systems.

Average annual CO₂ emissions

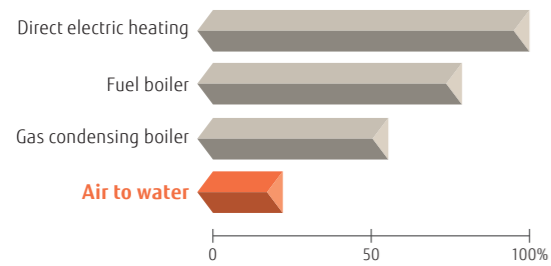

*Calculations based on energy efficiency data provided by the European Programme for Energy Efficiency in EU-27: 89% for fuel boilers; 93% for gas boiler

Clean
and Healthy

As an Air to water system does not use a burner to heat water, it does not produce NO_x or other harmful substances.



Environmentally friendly heating system



Low
Running Cost

High-efficiency heat pump technology keeps the running cost of an Air to water system.

Average annual running cost

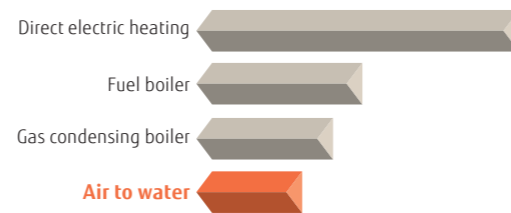

*The running cost may vary depending on a system's installation, geographical location, and operating conditions.

Easy
Installation and Maintenance

All components are built into a compact outdoor unit or a Hydraulic unit.



Well-designed Hydraulic unit
The sophisticated arrangement of Hydraulic units makes piping and maintenance work easy.

Energy Efficiency Standards Product labels

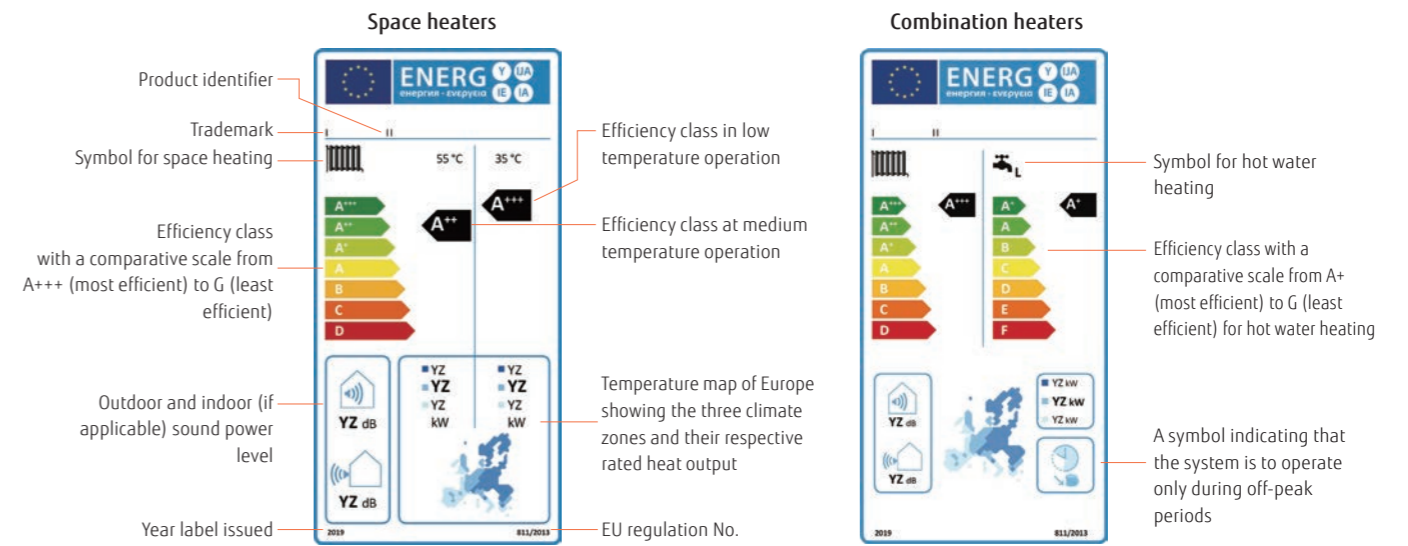

The Ecodesign Directive Lot 1 Regulation 813/2013

The Ecodesign directive defines a regulatory framework for improving the environmental performance of energy-related products (ErP) through design. Since September 26, 2015, the Ecodesign Directive has applied to space heaters, including heat pumps and fossil fuel fired boilers, combination heaters for space and hot water heating, water heaters, and water storage tanks.

All of these products must meet minimum requirements for energy efficiency*¹ and maximum sound power level. The minimum energy efficiency class were raised on September 26, 2017, and the maximum sound levels were lowered on September 26, 2018.

*1: Energy efficiency is expressed in terms of seasonal space heating efficiencies (η_s). The value is based upon the Seasonal Coefficient of Performance (SCOP).

The Energy Labelling Directive (EU) No. 811/2013

Energy label is intended to enable consumers to make direct comparisons of energy use and product features. All labels should indicate the product identifier, efficiency class, sound power level, and heat output. Heat generators are rated A+++ to D. There are two different product labels. One for space heaters and one for combination heaters.

Seasonal space heating Energy efficiency class

Class	Except low temp. HP 55°C	Low temp. HP 35°C
A+++	η _s ≥ 150	η _s ≥ 175
A++	125 ≤ η _s < 150	150 ≤ η _s < 175
A+	98 ≤ η _s < 125	123 ≤ η _s < 150
A	90 ≤ η _s < 98	115 ≤ η _s < 123
B	82 ≤ η _s < 90	107 ≤ η _s < 115
C	75 ≤ η _s < 82	100 ≤ η _s < 107
D	36 ≤ η _s < 75	61 ≤ η _s < 100
E	34 ≤ η _s < 36	59 ≤ η _s < 61
F	30 ≤ η _s < 34	55 ≤ η _s < 59
G	η _s < 30	η _s < 55

EHPA Quality Label



Fujitsu General's Air to water² has acquired the EHPA Quality Label³ through testing in accordance with the International Standards EN14511 and EN17025. The EHPA Quality Label³ is a label that shows the end-consumer a quality heat pump unit on the market.

*2: 3-phase High Power Series only
*3: Learn more about the validity of the mark at www.ehpa.org/quality/quality-label/

SG ready Label



SG ready is a label issued to heat pumps and their control technologies that meet the requirements set by BWP⁴, and technologies that conform to their standards can be integrated into a smart grid. SG ready labeled heat pumps receive signals from the power grid and PV systems with regard to energy and renewable energy sources such as wind, solar, and water. All of Fujitsu General's new heat pump series are SG ready compatible.

*4: BWP: Bundesverband Wärmepumpe e.V. (Federal German Heat Pump Association)

The CEN Heat Pump KEYMARK



The Heat Pump KEYMARK is a full certificate supporting the quality of heat pumps in the European market. The Heat Pump KEYMARK is a voluntary, independent, European certification mark (ISO Type 5 Certification) for all heat pumps, combination heat pumps, and hot water heaters (as covered by Ecodesign, EU Regulation 813/2013 and 814/2013). Fujitsu General's Air to water⁵ has acquired the KEYMARK certificate⁶.

*5: R32 refrigerant comfort model only
*6: Learn more about the validity of the mark at www.heatpumpkeymark.com/about/

Home Heating & Domestic Hot Water Supply

A wide range of products to suit regional characteristics, family structures, and usage patterns. We provide a variety of products to meet the needs of customers from the heating-centered High Power Series to the reasonably priced Compact Series.

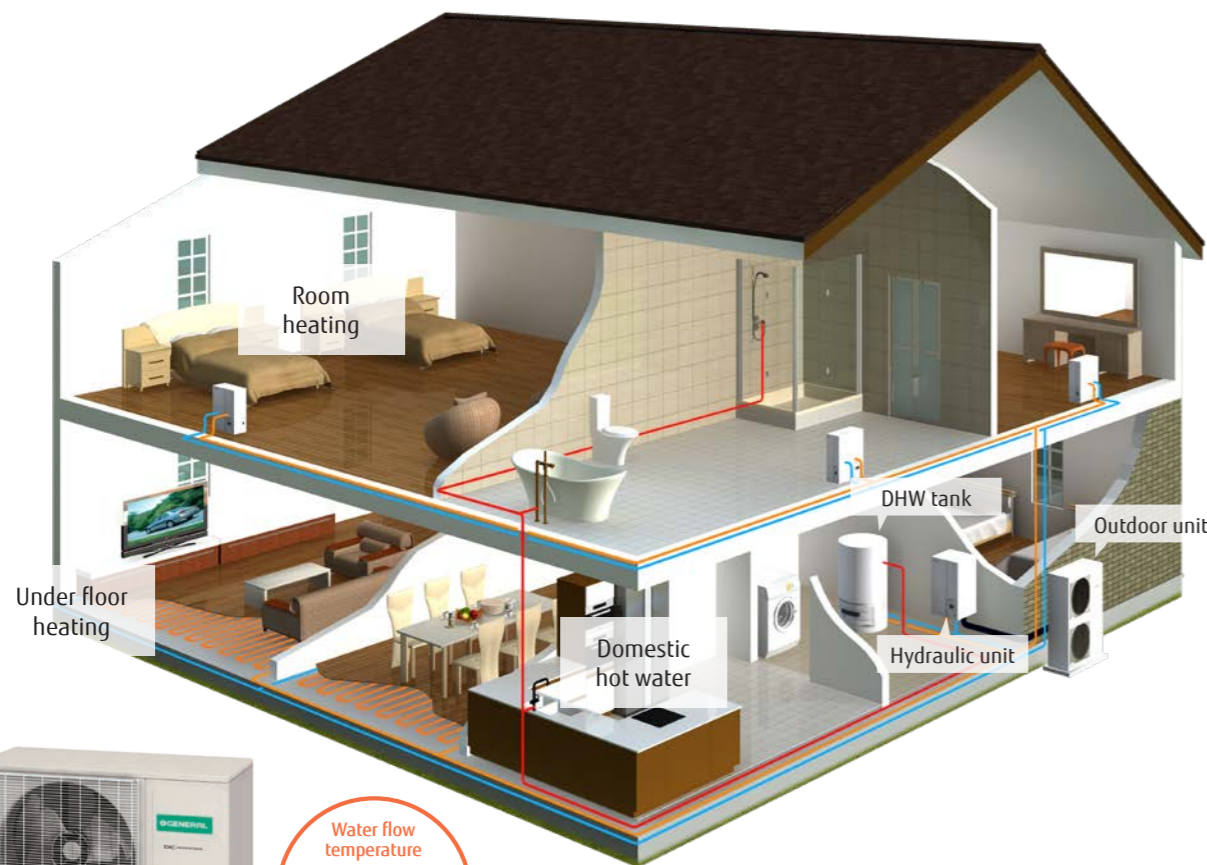

Water flow temperature
60°C

Super High Power Series
High Power Series

High water flow temperature

The temperature of water flow can be maintained at 60°C without using a backup heater, even when the outdoor temperature drops to -20°C.

Floor heating and domestic hot water supply

Outdoor units and hydraulic indoor units can be installed flexibly and easily. Hydraulic units installed inside the house prevent the circulating water from freezing. More units can be cascaded together to provide a greater heating capacity with greater flexibility.¹

¹: High Power Series only



Adopting R32 refrigerant

R32 refrigerant is an environmentally friendly refrigerant with a significantly lower Global Warming Potential (GWP) than conventional refrigerants.



+ DHW tank

A DHW tank (optional) can be connected to supply hot water.

+ Boiler

By combining with an existing boiler, powerful heating can be achieved even at low outdoor temperature.

* Please refer to page W-038 and W-039 for optional parts information.

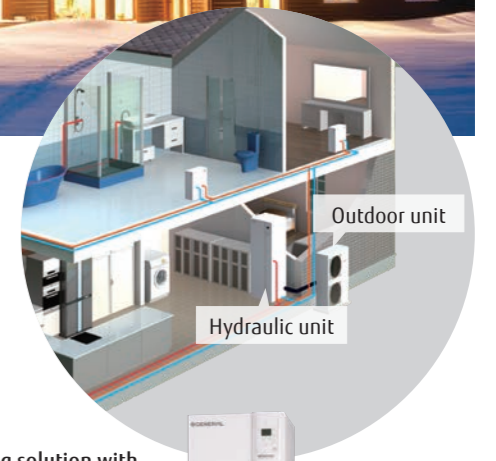

Stylish space saving solution with built-in DHW tank



Built-in DHW tank saves a great deal of space.

Existing boilers can be replaced easily. A higher heating capacity can be achieved with the flexibility to cascade more units.

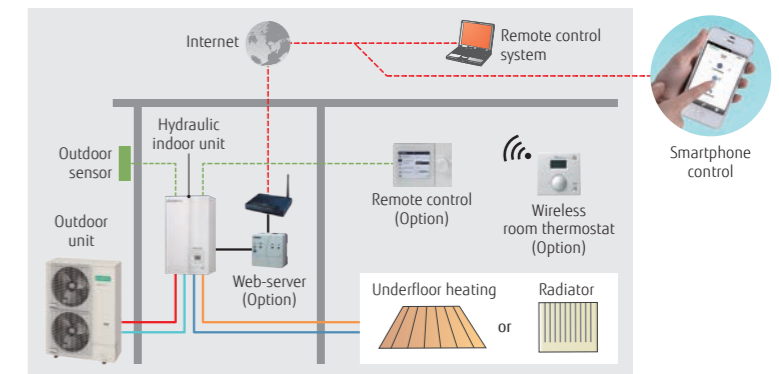

Smart control

To meet the diverse needs of customers, we offer a variety of control options, such as individual control and remote control options.

High-Efficiency Technology

Twin-Rotary Compressor



For Outdoor unit

Twin-Rotary Compressor with Linear Control Injection Port

The compressor achieves a high condensing temperature without overheating the discharge gas temperature due to the Linear control injection process used during compression. This makes the condensing temperature higher than in a normal circuit. Higher water temperatures can be achieved by controlling the injection volume according to usage conditions.

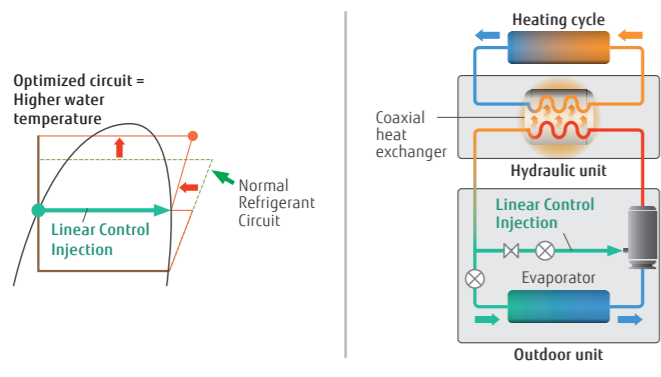

DC inverter technology controls temperatures precisely.

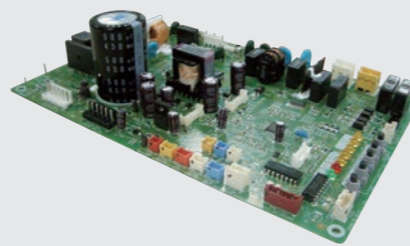
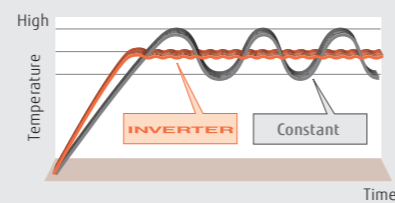

High-durability coaxial heat exchanger

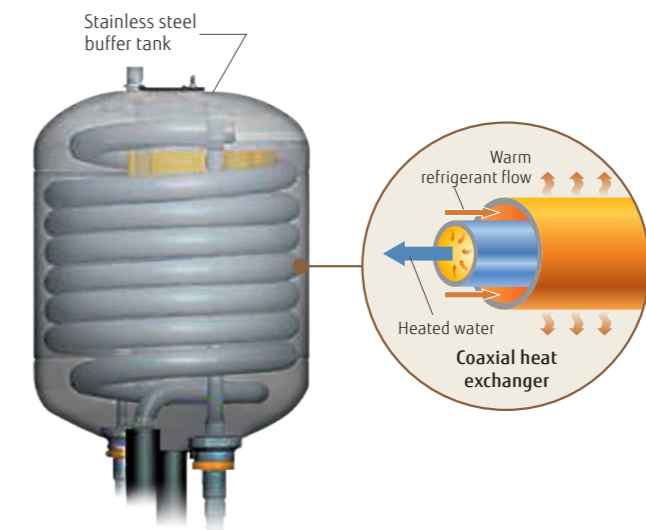

For Hydraulic unit

Stainless steel buffer tank

Heat exchange amount is 25% higher than the previous model. Energy-saving performance has also been improved.

- Anti-corrosion protection
- No flow switch required
- Anti-freeze protection not required

Class A Pump

Energy-saving pump with the ability to adjust the flow rate and pressure to a constant level



Split Type Comfort Series



Hydraulic indoor unit:
WSHA050ML3 / WSHA080ML3 /
WSHA100ML3
Outdoor unit:
WOHA060KLT / WOHA080KLT /
WOHA100KLT



Specifications

Model Name	Hydraulic unit	Outdoor unit	WSHA050ML3 WOHA060KLT	WSHA080ML3 WOHA060KLT	WSHA080ML3 WOHA080KLT	WSHA100ML3 WOHA100KLT
Capacity Range			5	6	8	10
7°C/35°C floor heating *1	Heating capacity	kW	4.50	5.50	7.50	9.50
	Input power		0.949	1.18	1.69	2.11
	COP		4.74	4.65	4.43	4.50
2°C/35°C floor heating *1	Heating capacity	kW	4.50	5.30	6.30	9.30
	Input power		1.33	1.65	1.96	3.08
	COP		3.39	3.22	3.21	3.02
-7°C/35°C floor heating *1	Heating capacity	kW	4.40	5.00	5.70	8.90
	Input power		1.59	1.90	2.13	3.36
	COP		2.76	2.63	2.68	2.65
-7°C/55°C Radiator *1	Heating capacity	kW	3.90	4.25	5.30	8.00
	Input power		2.11	2.25	2.79	4.10
	COP		1.85	1.89	1.90	1.95

Space heating characteristics*2		°C	55	35	55	35	55	35	55	35
Temperature application		°C	55	35	55	35	55	35	55	35
Energy efficiency class			A++	A+++	A++	A+++	A++	A+++	A++	A+++
Rated heat output (P _{rated})	kW		5	5	5	5	6	7	8	9
Seasonal space heating energy efficiency (η _s)	%		125	175	125	175	128	177	130	178
Annual energy consumption	kWh		3,035	2,322	3,411	2,594	3,903	2,982	5,083	3,875
Sound power level*3	Hydraulic unit	dB(A)	40	-	40	-	40	-	40	-
	Outdoor unit		57	-	57	-	60	-	62	-

Hydraulic unit specifications			Single phase, ~230 V, 50 Hz			
Power source			Single phase, ~230 V, 50 Hz			
Dimensions H × W × D	mm		847 × 450 × 493	847 × 450 × 493	847 × 450 × 493	847 × 450 × 493
Weight (Net)	kg		47	47	47	47
Water circulation	Min./Max. L/min		7.6/22.0	8.5/22.0	10.0/22.0	13.2/30.0
Buffer tank capacity	L		16	16	16	16
Expansion vessel capacity	L		8	8	8	8
Water flow temperature range	Max. °C		55	55	55	55
Water pipe connection diameter	Flow/Return mm		Ø25.4/Ø25.4	Ø25.4/Ø25.4	Ø25.4/Ø25.4	Ø25.4/Ø25.4
Backup heater	Capacity kW		3.0	3.0	3.0	3.0

Outdoor unit specifications			Single phase, ~230 V, 50 Hz			
Power source			Single phase, ~230 V, 50 Hz			
Current	Max. A		13.0	13.0	18.0	19.0
Dimensions H × W × D	mm		632 × 799 × 290	632 × 799 × 290	716 × 820 × 315	998 × 940 × 320
Weight (Net)	kg		39	39	42	62
Refrigerant	Type (Global Warming Potential)		R32 (675)	R32 (675)	R32 (675)	R32 (675)
	Charge	kg	0.97	0.97	1.02	1.63
Additional refrigerant charge		g/m	25	25	25	20
	Diameter	Liquid mm	6.35	6.35	6.35	9.52
Connection pipe	Gas	mm	12.70	12.70	12.70	15.88
	Length	Min./Max. m	3/30	3/30	3/30	3/30
	Length (Pre-charge)	m	15	15	15	20
	Height difference	Max. m	20	20	20	20
Operating range	Heating	°C	-20 to 35	-20 to 35	-20 to 35	-20 to 35

*1: Heating capacity, input power, and COP are measured using the EN14511 standard. Actual usage environments, such as the operating modes of the heating equipment, room temperature, and controller settings, may cause differences in values between those listed in the catalog and the actual performance characteristics.
*2: Information about ErP can be downloaded from our website at www.fujitsu-general.com/global/support/downloads/search/
*3: The sound power level values are based on EN12102 standard measurements under EN14825 standard conditions.

High water flow temperature

The temperature of water flow is up to 55°C without a backup heater. Hot water supply temperature can be maintained even at -10°C outdoor temperature.

* If you want to raise the temperature of the water supply to above the maximum temperature, use a backup heater to supplement the primary heater.



High COP

Heat pumps of ATW Systems work more efficiently and consume less energy than conventional heating systems.

Energy efficiency class **A+++***

*Temperature application: Heating temp. 35°C

Seasonal space heating energy efficiency (η_s)
Conditions: Outdoor Temp. 7°C Heating Temp. 35°C

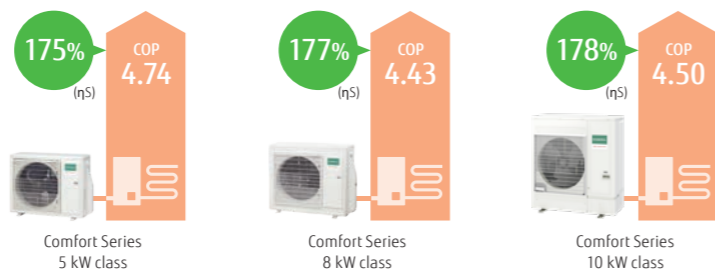

Outdoor unit technology



DC Fan Motor
High-performance, high-efficiency small DC fan motor mounted

DC Twin-Rotary Compressor
High-efficiency DC twin-rotary compressor

DC Inverter
DC inverter provides smooth water temperature control.

Dimensions

(Unit: mm)

Outdoor Unit:
WOHA060KLT

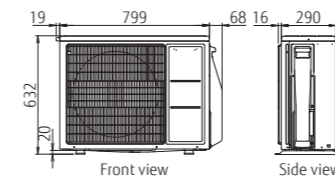

WOHA080KLT

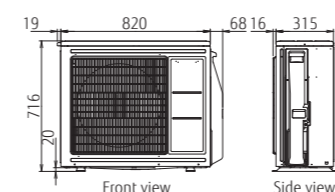

WOHA100KLT

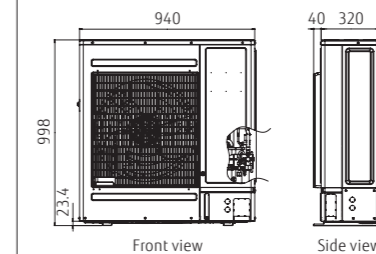

Hydraulic Indoor Unit:
WSHA050ML3/WSHA080ML3/WSHA100ML3

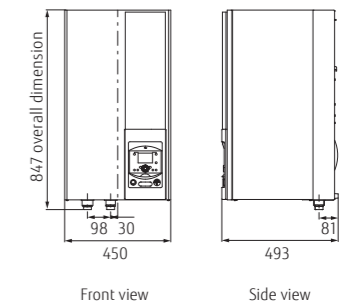

Split Type

Super High Power Series



High water flow temperature

The temperature of water flow can be maintained at 60°C without using a backup heater, even when the outdoor temperature drops to -20°C. The system can supply 55°C water without a backup heater at an outdoor temperature of -22°C.

* If you want to raise the temperature of the water supply to above the maximum temperature, use a backup heater to supplement the primary heater.

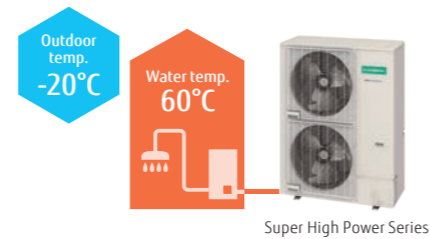

High COP

Heat pumps of ATW Systems work more efficiently and consume less energy than conventional heating systems.

Energy efficiency class



Seasonal space heating energy efficiency (η_s)

Conditions: Outdoor Temp. 7°C Heating Temp. 35°C

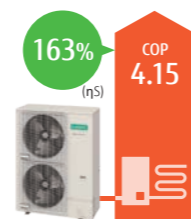

Single phase
16 kW class

Operating range extended to -25°C

Operating range improved down to -25°C outdoor temperature



Hydraulic indoor unit:
WSHG160DJ6
Outdoor unit:
WOHG160LJL



Specifications

Model Name	Hydraulic unit	Outdoor unit	WSHG160DJ6	WOHG160LJL	
Capacity range					
7°C/35°C floor heating *1	Heating capacity	kW	16.00	16	
	Input power		3.86		
	COP		4.15		
2°C/35°C floor heating *1	Heating capacity	kW	13.30		
	Input power		4.25		
	COP		3.13		
-7°C/35°C floor heating*1	Heating capacity	kW	14.50		
	Input power		5.27		
	COP		2.75		
-7°C/55°C Radiator*1	Heating capacity	kW	10.90		
	Input power		5.89		
	COP		1.85		
Space heating characteristics*2					
Temperature application	°C		55	35	
Energy efficiency class			A++	A++	
Rated heat output (P _{rated})	kW		14	16	
Seasonal space heating energy efficiency (η _s)	%		125	163	
Annual energy consumption	kWh		8,757	8,014	
Sound power level	Hydraulic unit	dB(A)	45	45	
	Outdoor unit		67	66	
Hydraulic unit specifications					
Power source	Single phase, ~230 V, 50 Hz				
Dimensions H × W × D	mm	805 × 450 × 471			
Weight (Net)	kg	52.5			
Water circulation	Min./Max.	L/min	26.4/57.8		
Buffer tank capacity	L	22			
Expansion vessel capacity	L	10			
Water flow temperature range	Max.	°C	60		
Water pipe connection diameter	Flow/Return	mm	Ø25.4/Ø25.4		
Backup heater	Capacity	kW	6.0 (3.0 kW × 2 pcs.)		
Outdoor unit specifications					
Power source	Single phase, ~230 V, 50 Hz				
Current	Max.	A	28.0		
Dimensions H × W × D	mm	1,428 × 1,080 × 480			
Weight (Net)	kg	137			
Refrigerant	Type (Global Warming Potential)	R410A (2,088)			
	Charge	kg	3.80		
Additional refrigerant charge		g/m	50		
Connection pipe	Diameter	Liquid	mm	Ø9.52	
		Gas		Ø15.88	
	Length	Min./Max.	m	5/30	
	Length (Pre-charge)		m	15	
Height difference	Max.	m	25/15 (Outdoor unit: Upper/Lower)		
	Heating	°C	-25 to 35		

*1: Heating capacity, input power, and COP are measured using the EN14511 standard. Actual usage environments, such as the operating modes of the heating equipment, room temperature, and controller settings, may cause differences in values between those listed in the catalog and the actual performance characteristics.

*2: Information about ErP can be downloaded from our website at www.fujitsu-general.com/global/support/downloads/search/

Dimensions

(Unit: mm)

Outdoor Unit:
WOHG160LJL

Hydraulic Indoor Unit:
WSHG160DJ6

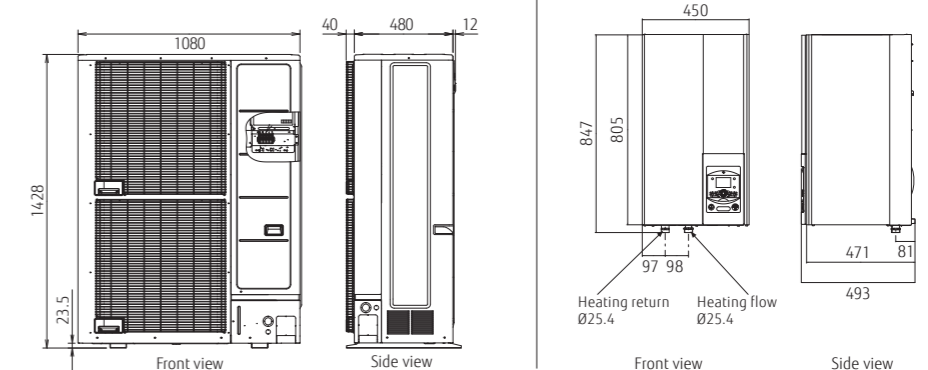

Split Type

High Power Series



High water flow temperature

The temperature of water flow can be maintained at 60°C without using a backup heater, even when the outdoor temperature drops to -20°C.

* If you want to raise the temperature of the water supply to above the maximum temperature, use a backup heater to supplement the primary heater.



High COP

Heat pumps of ATW Systems work more efficiently and consume less energy than conventional heating systems.

Energy efficiency class



*Temperature application: Heating temp. 35°C

Seasonal space heating energy efficiency (η_s)

Conditions: Outdoor Temp. 7°C Heating Temp. 35°C

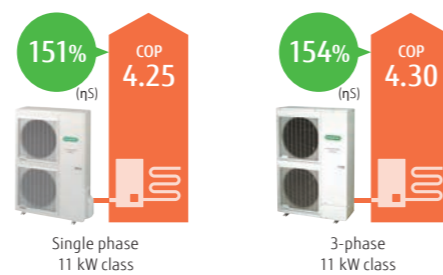

Hydraulic indoor unit:
WSHG140DG
Outdoor unit:
WOHG112LHT / WOHG140LCTA
[3 phase] WOHK112LCTA / WOHK140LCTA /
WOHK160LCTA



Specifications

Model Name	Hydraulic unit	WSHG140DG	WSHG140DG	WSHG140DG	WSHG140DG	WSHG140DG
	Outdoor unit	WOHG112LHT	WOHG140LCTA	WOHK112LCTA	WOHK140LCTA	WOHK160LCTA
Capacity range		11	14	11	14	16
7°C/35°C floor heating *1	Heating capacity	10.80	13.50	10.80	13.50	15.17
	Input power	2.54	3.23	2.51	3.20	3.70
	COP	4.25	4.18	4.30	4.22	4.10
2°C/35°C floor heating *1	Heating capacity	10.77	12.00	10.77	13.00	13.50
	Input power	3.44	3.87	3.40	4.15	4.34
	COP	3.13	3.10	3.17	3.13	3.11
-7°C/35°C floor heating*1	Heating capacity	10.38	11.54	10.38	12.20	13.50
	Input power	4.32	5.08	4.28	5.13	5.40
	COP	2.40	2.27	2.43	2.38	2.50
-7°C/55°C Radiator*1	Heating capacity	7.57	9.20	9.27	10.10	11.00
	Input power	4.57	5.08	5.09	5.65	6.29
	COP	1.66	1.81	1.82	1.79	1.75

Space heating characteristics*2

Temperature application	°C	55	35	55	35	55	35	55	35	55	35
Energy efficiency class		A+	A++	A+	A+	A+	A++	A+	A++	A+	A+
Rated heat output (P _{rated})	kW	9	11	11	13	9	11	11	13	13	14
Seasonal space heating energy efficiency (η _s)	%	112	151	113	148	112	154	117	150	117	149
Annual energy consumption	kWh	6,704	6,062	8,041	6,824	6,669	5,930	7,803	6,738	9,062	7,408
Sound power level	Hydraulic unit	46	46	46	46	46	46	46	46	46	46
	Outdoor unit	68	69	69	69	68	70	68	71	71	71

Hydraulic unit specifications

Power source		Single phase, ~230 V, 50 Hz	3-phase, ~400 V, 50 Hz
Dimensions H × W × D	mm	800 × 450 × 457	800 × 450 × 457
Weight (Net)	kg	40	40
Water circulation	Min./Max. L/min	19.5/39.0	24.4/48.7
Buffer tank capacity	L	16	16
Expansion vessel capacity	L	8	8
Water flow temperature range	Max. °C	60	60
Water pipe connection diameter	Flow/Return mm	Ø25.4/Ø25.4	Ø25.4/Ø25.4
Backup heater	Capacity kW	-	-

Outdoor unit specifications

Power source		Single phase, ~230 V, 50 Hz	3-phase, ~400 V, 50 Hz
Current	Max. A	22.0	25.0
Dimensions H × W × D	mm	1,290 × 900 × 330	1,290 × 900 × 330
Weight (Net)	kg	92	99
Refrigerant	Type (Global Warming Potential)	R410A (2,088)	
	Charge	2.50	2.50
Additional refrigerant charge	Liquid	50	50
	Gas	Ø9.52	Ø15.88
Connection pipe	Diameter	mm	Ø9.52
	Length	Min./Max. m	5/20
	Length (Pre-charge)	m	15
Height difference	Max. m	15	15
	Heating	°C	-25 to 35

*1: Heating capacity, input power, and COP are measured using the EN14511 standard. Actual usage environments, such as the operating modes of the heating equipment, room temperature, and controller settings, may cause differences in values between those listed in the catalog and the actual performance characteristics.
 *2: Information about EIP can be downloaded from our website at www.fujitsu-general.com/global/support/downloads/search/

Dimensions

(Unit: mm)

Outdoor Unit:
 Single phase: WOHG112LHT/WOHG140LCTA

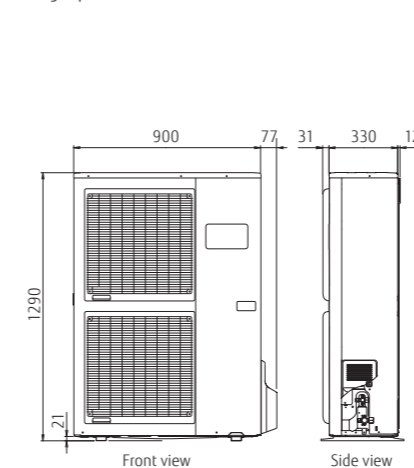

3 phase: WOHK112LCTA/WOHK140LCTA/WOHK160LCTA

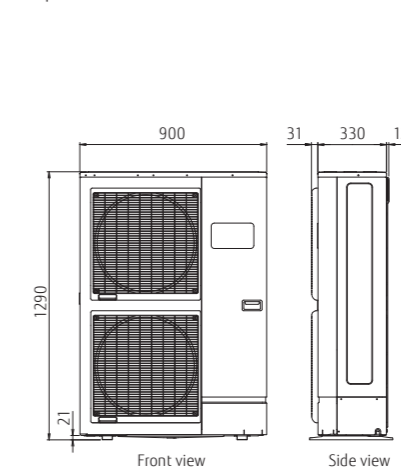

Hydraulic Indoor Unit:
 WSHG140DG

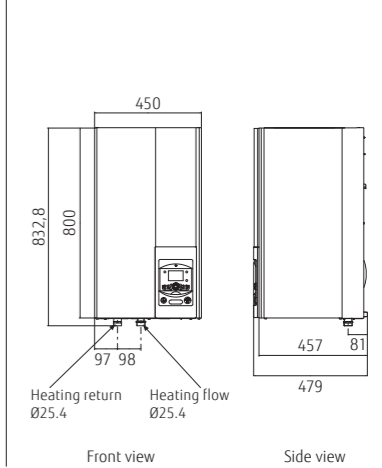

Split DHW Integrated Type

Comfort Series



Hydraulic indoor unit:
WGHA050ML3 / WGHA080ML3 /
WGHA100ML3
Outdoor unit:
WOHA060KLT / WOHA080KLT /
WOHA100KLT



Specifications

Model Name	Hydraulic unit	WGHA050ML3	WGHA080ML3	WGHA080ML3	WGHA100ML3				
	Outdoor unit	WOHA060KLT	WOHA060KLT	WOHA080KLT	WOHA100KLT				
Capacity range		5	6	8	10				
7°C/35°C floor heating *1	Heating capacity	4.50	5.50	7.50	9.50				
	Input power	0.949	1.18	1.69	2.11				
	COP	4.74	4.65	4.43	4.50				
2°C/35°C floor heating *1	Heating capacity	4.50	5.30	6.30	9.30				
	Input power	1.33	1.65	1.96	3.08				
	COP	3.39	3.22	3.21	3.02				
-7°C/35°C floor heating *1	Heating capacity	4.40	5.00	5.70	8.90				
	Input power	1.59	1.90	2.13	3.36				
	COP	2.76	2.63	2.68	2.65				
-7°C/55°C Radiator *1	Heating capacity	3.90	4.25	5.30	8.00				
	Input power	2.11	2.25	2.79	4.10				
	COP	1.85	1.89	1.90	1.95				
Space heating characteristics**									
Temperature application	°C	55	35	55	35	55	35	55	35
Energy efficiency class		A++	A+++	A++	A+++	A++	A+++	A++	A+++
Rated heat output (P _{rated})	kW	5	5	5	6	6	7	8	9
Seasonal space heating energy efficiency (η _s)	%	125	175	125	175	128	177	130	178
Annual energy consumption	kWh	3,035	2,322	3,411	2,594	3,903	2,982	5,083	3,875
Sound power level*3	Hydraulic unit	40	-	40	-	40	-	40	-
	Outdoor unit	57	-	57	-	60	-	62	-
Domestic hot water characteristics**									
Load profile		L	L	L	L				
Energy efficiency class		A+	A+	A+	A+				
Energy efficiency (η _{wh})	%	130	130	130	130				
Annual electricity consumption	kWh	793	793	793	793				
Hydraulic unit specifications									
Power source		Single phase, ~230 V, 50 Hz							
Dimensions H × W × D	mm	1,863 × 648 × 700	1,863 × 648 × 700	1,863 × 648 × 700	1,863 × 648 × 700				
Weight (Net)	kg	145	145	145	145				
Water circulation	Min./Max. L/min	7.6/22.0	8.5/22.0	10.0/22.0	13.2/30.0				
DHW capacity	L	190	190	190	190				
Electrical heater capacity	Heating	3.0	3.0	3.0	3.0				
	DHW	1.5	1.5	1.5	1.5				
Buffer tank capacity	L	16	16	16	16				
Expansion vessel capacity	L	8	8	8	8				
Water flow temperature range	Max. °C	55	55	55	55				
Water pipe connection diameter	Flow/Return mm	Ø25.4/Ø25.4	Ø25.4/Ø25.4	Ø25.4/Ø25.4	Ø25.4/Ø25.4				
Hot water pipe connection diameter	mm	Ø19.05	Ø19.05	Ø19.05	Ø19.05				
Outdoor unit specifications									
Power source		Single phase, ~230 V, 50 Hz							
Current	Max. A	13.0	13.0	18.0	19.0				
Dimensions H × W × D	mm	632 × 799 × 290	632 × 799 × 290	716 × 820 × 315	998 × 940 × 320				
Weight (Net)	kg	39	39	42	62				
Refrigerant	Type (Global Warming Potential)	R32 (675)							
	Charge	kg	0.97	0.97	1.02	1.63			
Additional refrigerant charge	Diameter	Liquid	25	25	25	20			
	Gas	6.35	6.35	6.35	9.52				
Connection pipe	Length	m	12.70	12.70	12.70	15.88			
	Length (Pre-charge)	Min./Max. m	3/30	3/30	3/30	3/30			
	Height difference	Max. m	15	15	15	20			
Operating range	Heating	°C	-20 to 35	-20 to 35	-20 to 35	-20 to 35			

High water flow temperature

The temperature of water flow is up to 55°C without a backup heater. Hot water supply temperature can be maintained even at -10°C outdoor temperature.



* If you want to raise the temperature of the water supply to above the maximum temperature, use a backup heater to supplement the primary heater.

High COP

Heat pumps of ATW Systems work more efficiently and consume less energy than conventional heating systems.

Energy efficiency class **A+++***

*Temperature application: Heating temp. 35°C

Seasonal space heating energy efficiency (η_s)
 Conditions: Outdoor Temp. 7°C Heating Temp. 35°C

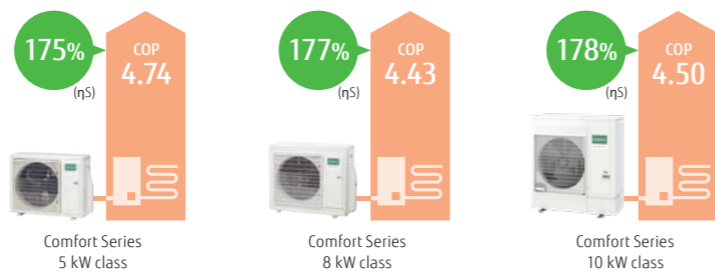

Outdoor unit technology



DC Fan Motor
 High-performance, high-efficiency small DC fan motor mounted

DC Twin-Rotary Compressor
 High-efficiency DC twin-rotary compressor

DC Inverter
 DC inverter provides smooth water temperature control.

*1: Heating capacity, input power, and COP are measured using the EN14511 standard. Actual usage environments, such as the operating modes of the heating equipment, room temperature, and controller settings, may cause differences in values between those listed in the catalog and the actual performance characteristics.
 *2: Information about ErP can be downloaded from our website at www.fujitsu-general.com/global/support/downloads/search/
 *3: The sound power level values are based on EN12102 standard measurements under EN14825 standard conditions.

Dimensions

(Unit: mm)

Outdoor Unit:
 WOHA060KLT

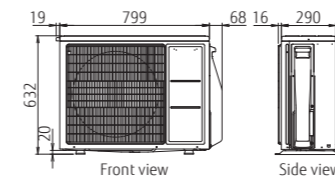

WOHA080KLT

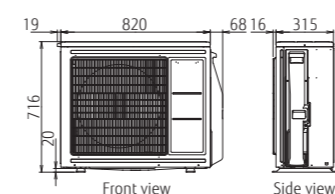

WOHA100KLT

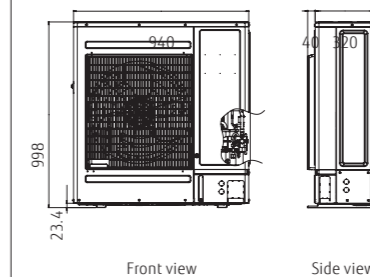

Hydraulic Indoor Unit:
 WGHA050ML3/WGHA080ML3/WGHA100ML3

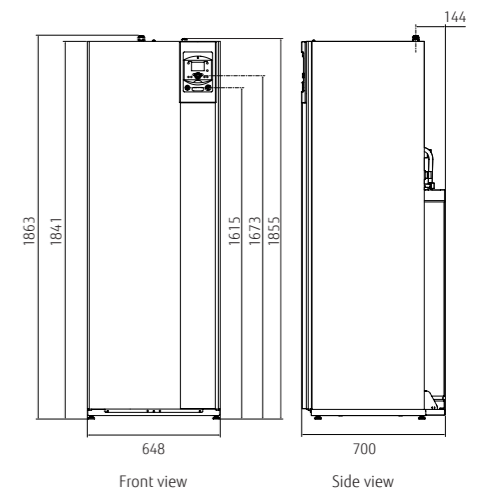

Split DHW Integrated Type

Super High Power Series



High water flow temperature

The temperature of water flow can be maintained at 60°C without using a backup heater, even when the outdoor temperature drops to -20°C. The system can supply 55°C water without a backup heater at an outdoor temperature of -22°C.

* If you want to raise the temperature of the water supply to above the maximum temperature, use a backup heater to supplement the primary heater.

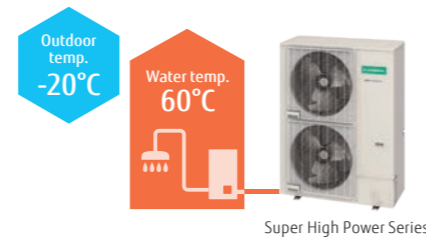

High COP

Heat pumps of ATW Systems work more efficiently and consume less energy than conventional heating systems.

Energy efficiency class



Seasonal space heating energy efficiency (η_s)

Conditions: Outdoor Temp. 7°C Heating Temp. 35°C

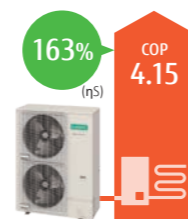

Single phase
16 kW class

Operating range extended to -25°C

Operating range improved down to -25°C outdoor temperature

Stylish space saving solution with **Built-in High-performance DHW tank 190 L**

- Coil heat exchanger optimizes DHW supply performance.
- Temperature rises quickly due to the large surface of the exchanger.

Hydraulic indoor unit:

WGHG160DJ6

Outdoor unit:

WOHG160LJL



Hydraulic unit
Single phase



Outdoor unit
Single phase 16 kW

Specifications

Model Name	Hydraulic unit	WGHG160DJ6	WOHG160LJL
Capacity range		16	
7°C/35°C floor heating *1	Heating capacity	16.00	
	Input power	3.86	
	COP	4.15	
2°C/35°C floor heating *1	Heating capacity	13.30	
	Input power	4.25	
	COP	3.13	
-7°C/35°C floor heating*1	Heating capacity	14.50	
	Input power	5.27	
	COP	2.75	
-7°C/55°C Radiator*1	Heating capacity	10.90	
	Input power	5.89	
	COP	1.85	
Space heating characteristics**			
Temperature application	°C	55	35
Energy efficiency class		A++	A++
Rated heat output (P _{rated})	kW	14	16
Seasonal space heating energy efficiency (η _s)	%	125	163
Annual energy consumption	kWh	8,757	8,014
Sound power level	Hydraulic unit	45	45
	Outdoor unit	67	66
Domestic hot water characteristics**			
Load profile		L	
Energy efficiency class		A	
Energy efficiency (n _{wh})	%	109	
Annual electricity consumption	kWh	941	
Hydraulic unit specifications			
Power source		Single phase, ~230 V, 50 Hz	
Dimensions H × W × D	mm	1,841 × 648 × 698	
Weight (Net)	kg	166	
Water circulation	Min./Max.	L/min	
		26.4/57.8	
DHW capacity	L	190	
Electrical heater capacity	Heating	6.0 (3.0 kW × 2 pcs.)	
	DHW	1.5	
Buffer tank capacity	L	22	
Expansion vessel capacity	L	12	
Water flow temperature range	Max.	°C	
		60	
Water pipe connection diameter	Flow/Return	mm	
		Ø25.4/Ø25.4	
Hot water pipe connection diameter		mm	
		Ø19.05	
Outdoor unit specifications			
Power source		Single phase, ~230 V, 50 Hz	
Current	Max.	A	
		28.0	
Dimensions H × W × D	mm	1,428 × 1,080 × 480	
Weight (Net)	kg	137	
Refrigerant	Type (Global Warming Potential)	R410A (2,088)	
Charge	kg	3.80	
Additional refrigerant charge	g/m	50	
Connection pipe	Diameter	Liquid	mm
		Gas	mm
	Length	Min./Max.	m
	Length (Pre-charge)		m
Height difference	Max.	m	25/15 (Outdoor unit: Upper/Lower)
Operating range	Heating	°C	
		-25 to 35	

*1: Heating capacity, input power, and COP are measured using the EN14511 standard. Actual usage environments, such as the operating modes of the heating equipment, room temperature, and controller settings, may cause differences in values between those listed in the catalog and the actual performance characteristics.

*2: Information about ErP can be downloaded from our website at www.fujitsu-general.com/global/support/downloads/search/

Dimensions

(Unit: mm)

Outdoor Unit:
WOHG160LJL

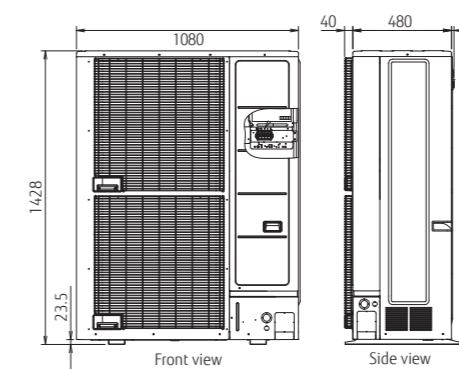

Hydraulic Indoor Unit:
WGHG160DJ6

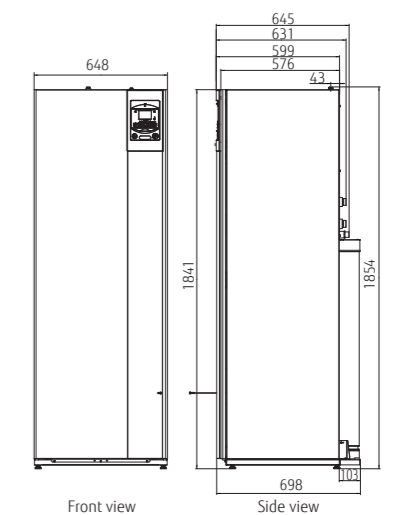

Split DHW Integrated Type

High Power Series



High water flow temperature

The temperature of water flow can be maintained at 60°C without using a backup heater, even when the outdoor temperature drops to -20°C.

* If you want to raise the temperature of the water supply to above the maximum temperature, use a backup heater to supplement the primary heater.



High COP

Heat pumps of ATW Systems work more efficiently and consume less energy than conventional heating systems.



*Temperature application: Heating temp. 35°C

Seasonal space heating energy efficiency (η_s)

Conditions: Outdoor Temp. 7°C Heating Temp. 35°C

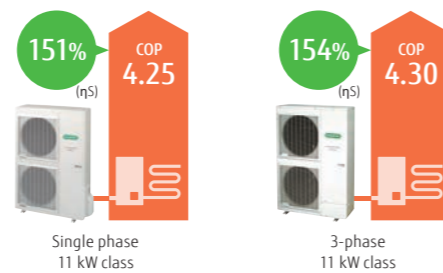

Optimized refrigerant cycle operation

The High Power Series deliver high performance and efficiency with twin sensors and hot water heating technology.

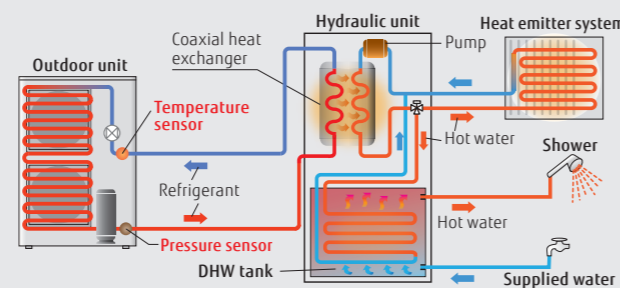

Hydraulic indoor unit:
WGHG140DG
Outdoor unit:
WOHG112LHT / WOHG140LCTA
[3 phase] WOHK112LCTA / WOHK140LCTA / WOHK160LCTA



Specifications

Model Name	Hydraulic unit		WGHG140DG		WGHG140DG		WGHG140DG		WGHG140DG		WGHG140DG		
	Outdoor unit		WOHG112LHT	WOHG140LCTA	WOHK112LCTA	WOHK140LCTA	WOHK140LCTA	WOHK140LCTA	WOHK160LCTA	WOHK160LCTA			
Capacity range			11	14	11	14	14	16					
7°C/35°C floor heating *1	Heating capacity	kW	10.80	13.50	10.80	13.50	13.50	15.17					
	Input power		2.54	3.23	2.51	3.20	3.70	4.10					
	COP		4.25	4.18	4.30	4.22	4.10	4.10					
2°C/35°C floor heating *1	Heating capacity	kW	10.77	12.00	10.77	13.00	13.50	13.50					
	Input power		3.44	3.87	3.40	4.15	4.34	4.34					
	COP		3.13	3.10	3.17	3.13	3.11	3.11					
-7°C/35°C floor heating*1	Heating capacity	kW	10.38	11.54	10.38	12.20	13.50	13.50					
	Input power		4.32	5.08	4.28	5.13	5.40	5.40					
	COP		2.40	2.27	2.43	2.38	2.50	2.50					
-7°C/55°C Radiator*1	Heating capacity	kW	7.57	9.20	9.27	10.10	11.00	11.00					
	Input power		4.57	5.08	5.09	5.65	6.29	6.29					
	COP		1.66	1.81	1.82	1.79	1.75	1.75					
Space heating characteristics*2													
Temperature application	°C		55	35	55	35	55	35	55	35	55	35	
Energy efficiency class			A+	A++	A+	A+	A+	A++	A+	A++	A+	A+	
Rated heat output (P _{rated})	kW		9	11	11	13	9	11	11	13	13	14	
Seasonal space heating energy efficiency (η _s)	%		112	151	113	148	112	154	117	150	117	149	
Annual energy consumption	kWh		6,704	6,062	8,041	6,824	6,669	5,930	7,803	6,738	9,062	7,408	
Sound power level	Hydraulic unit	dB(A)	46		46		46		46		46		
	Outdoor unit		68		69		69		68		71		
Domestic hot water characteristics*2													
Load profile											L		
Energy efficiency class											A		
Energy efficiency (η _{wh})	%										88		
Annual electricity consumption	kWh										1166		
Hydraulic unit specifications													
Power source			Single phase, ~230 V, 50 Hz				3-phase, ~400 V, 50 Hz						
Dimensions H × W × D	mm		1,840 × 648 × 698										
Weight (Net)	kg		150										
Water circulation	Min./Max.	L/min	19.5/39.0	24.4/28.7	19.5/39.0	24.4/48.7	27.4/54.8						
DHW capacity	L		190										
Electrical heater capacity	Heating	kW					1.5						
	DHW						16						
Expansion vessel capacity	L		12										
Water flow temperature range	Max.	°C	60										
Water pipe connection diameter	Flow/Return	mm	Ø25.4/Ø25.4										
Hot water pipe connection diameter	mm		Ø19.05										
Outdoor unit specifications													
Power source			Single phase, ~230 V, 50 Hz				3-phase, ~400 V, 50 Hz						
Current	Max.	A	22.0	25.0	9.0	9.5	10.5						
Dimensions H × W × D	mm		1,290 × 900 × 330										
Weight (Net)	kg		92				99						
Refrigerant	Type (Global Warming Potential)									R410A (2,088)			
	Charge	kg	2.50		50								
Additional refrigerant charge	g/m		50										
Connection pipe	Diameter	Liquid	mm		Ø9.52								
		Gas	mm		Ø15.88								
	Length	Min./Max.	m		5/20								
	Length (Pre-charge)	m		15									
Height difference	Max.	m		15									
	Heating	°C		-25 to 35									

*1: Heating capacity, input power, and COP are measured using the EN14511 standard. Actual usage environments, such as the operating modes of the heating equipment, room temperature, and controller settings, may cause differences in values between those listed in the catalog and the actual performance characteristics.

*2: Information about ErP can be downloaded from our website at www.fujitsu-general.com/global/support/downloads/search/

Dimensions

(Unit: mm)

Outdoor Unit:

Single phase: WOHG112LHT/WOHG140LCTA

3 phase: WOHK112LCTA/WOHK140LCTA/WOHK160LCTA

Hydraulic Indoor Unit:

WGHG140DG

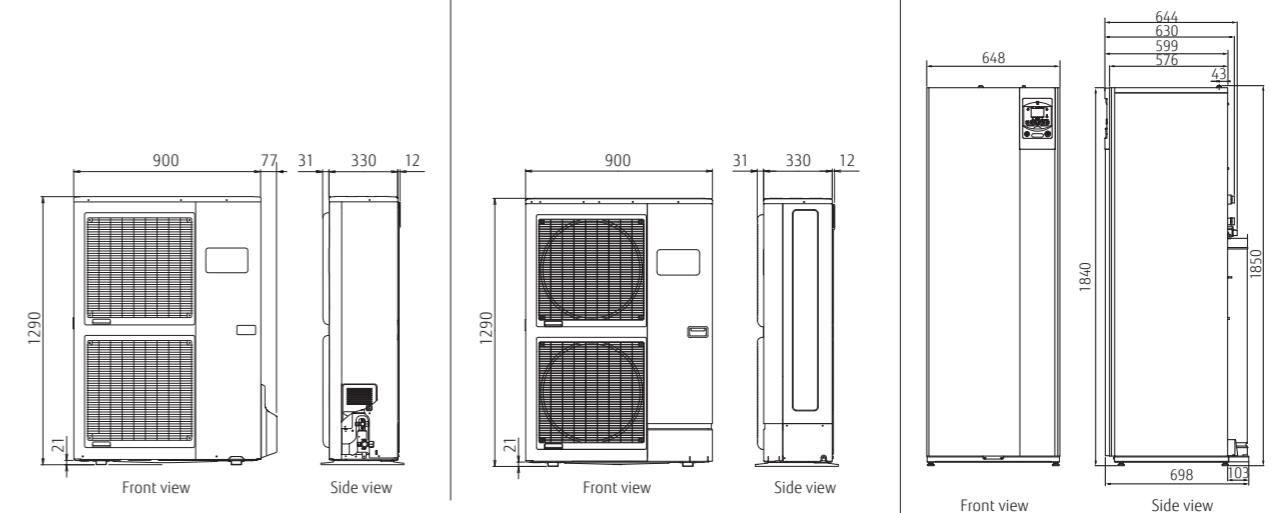

Comfort Control

The high-grade heating controller automatically adjusts the flow temperature according to the climate conditions to maintain the room and domestic hot water temperatures at the desired levels.

Hydraulic unit Controller 4 Heating modes

- 1. Automatic mode**
Enables automatic switching between Comfort mode and Reduce mode according to time program
- 2. Reduce mode**
Maintains water temperature at a lower level
- 3. Comfort mode**
Maintains water temperature at a comfortable level
- 4. Protection mode**
Activates frost protection in standby operation



Useful Features

Automatic heating curve control

Automatic temperature regulation according to heating curve (depending on heating terminal and outdoor temperature)

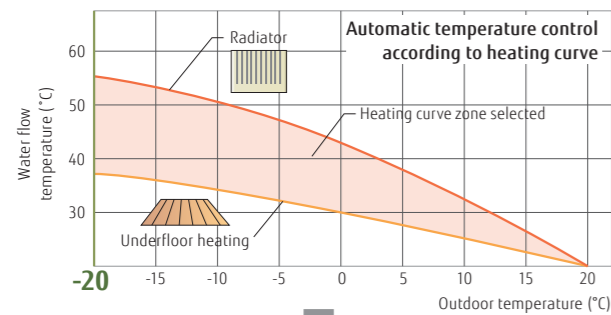

The heating curve will shift to adjust the room temperature setting.

Can be fine-adjusted when it is too warm or too cold.

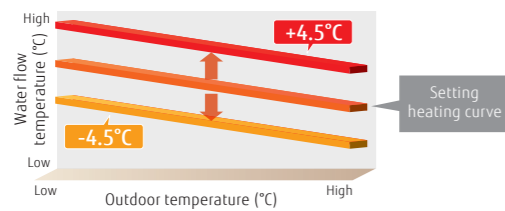

Quick recovery from defrosting

Maintains room temperature by boost start operation during defrosting.

Auto changeover

When cooling mode is selected, the system automatically switches between cooling and heating modes depending on the outdoor temperature to serve as an all-season air conditioner.

2-zone independent control

2-zone independent control (For example, the individual control of 2 underfloor heating zones or the combination of 1 underfloor heating zone and 1 radiator zone)*1

*1: Optional parts required

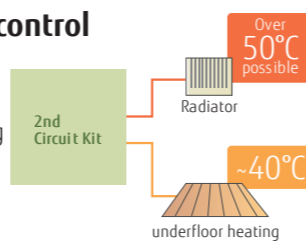

2-stage low-noise mode

The outdoor unit can be switched to quiet mode, depending on the installation environment.

*Effective only for High Power Series

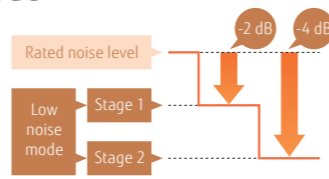

Backup heater operation

Backup heater maintains a comfortable room temperature even when the outside temperature is low. The backup heater is intelligently controlled as a safety backup for very cold days and nights, and only operates when really needed.

* Optional parts is needed for High power Series.

Energy Saving

Time program

- The timer is easy to set.
- You can select the heating mode in conjunction with various times of the day.

Day-weekly timer

- Allows up to 3 settings per day.
- Allows individual settings for each day of the week.

Holiday timer

- Allows up to 8 settings.
- While you are away from home for an extended period during winter, the system prevents your room or house from freezing.

Peak cut Function*2

Sets the peak current value to reduce power consumption.

Mode	Ratio to reduce power consumption
1	100%
2	75%
3	50%
4	Almost 0%

* Please refer to page W-038 and W-039 for optional parts information.

Safety Features

Anti-Legionella function

Prevents the growth of Legionella bacteria in the DHW tank to supply safe and clean hot water at all times.



Anti-freeze function

When the outside temperature drops below a specified level, the compressor will self-activate and water will also be automatically circulated to prevent freezing.

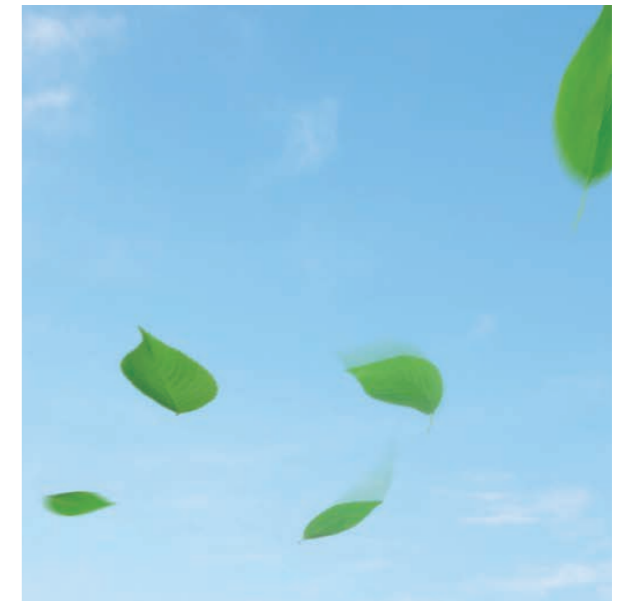
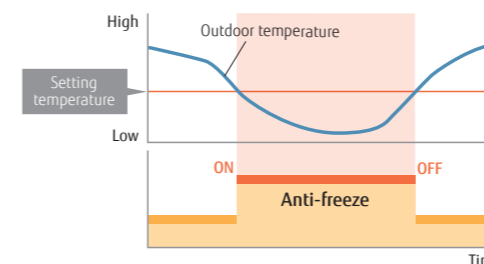

Emergency operation

If an outdoor unit fails to operate, a built-in backup heater or an external boiler is activated to supply an uninterrupted supply of hot water to the house.

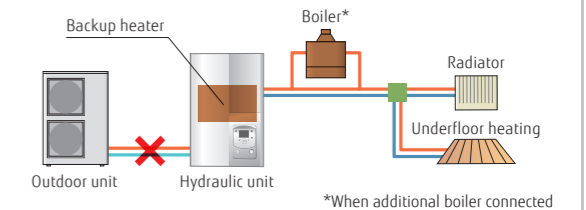

Error and Maintenance Alarm

Enables quick error-handling services and maintenance



- Error history saves 10 errors in memory
- Display telephone number of service company



Simple installation

Presetting configurations

A controller installed makes it easy to configure the system without having to set each component or unit individually.

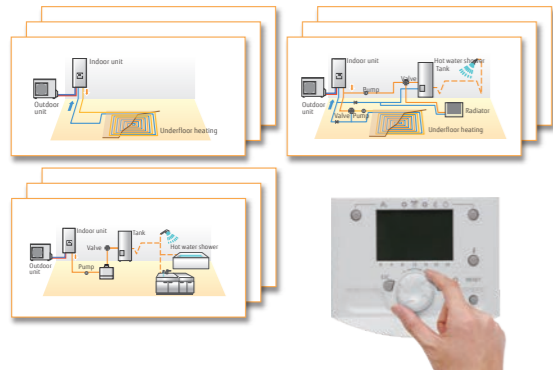

8 simple patterns for system presetting (Pair of heating: 12 patterns)

Configuration (Parameter 5700)	Installation type
Presetting 1	1 heating circuit
Presetting 2	2 heating circuits
Presetting 3	1 heating circuit with boiler backup
Presetting 4	2 heating circuits with boiler backup
Presetting 5	1/2 heating circuit with buffer control
Presetting 6	1/2 heating circuit with buffer control and boiler backup
Presetting 7	Cascade connection Primary
Presetting 8	Cascade connection A
Presetting 9	Cascade connection B/C

- DHW & solar control auto detection
- Cascade connection only available in High Power models.

Outdoor temperature simulation

It verifies that each unit operates properly under the set conditions and expected outdoor air temperature when the system is actually assembled.

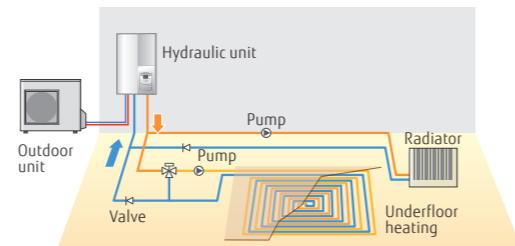

The outdoor temperatures can be simulated in the range of -50°C to +50°C.

Concrete floor drying

Allows the concrete surrounding the hot-water pipes to dry more quickly, shortening the construction period for underfloor heating installations.

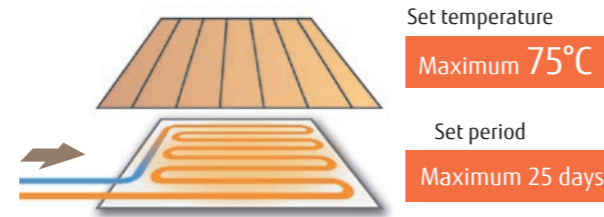

Controller with a large liquid crystal display and buttons for easy function setting

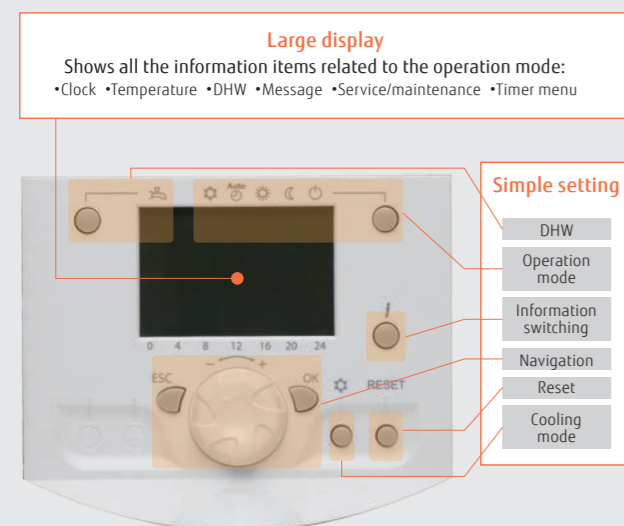

Main operation flow and settings for installers and end users

	Flow Chart	Example Item
Installers	1 Install Setting	Pump speed setting, Configuration, Heating curve setting, Heat pump shut off
	2 Option Setting	Cooling kit, DHW kit, Boiler kit
	3 Convenient Function	Automatic heating curve setting, Underfloor controlled driving, Outdoor temperature adjustment, Maintenance period setting
	4 Workout Setting	Outdoor temperature simulator
	5 Confirmation	Checking operation (Heating and cooling, DHW, option)
End users	6 User Setting	Date and time, Time program, Operation temperature setting

Easy Installation & Maintenance

- All hydraulic safety and control components are built in with no additional selection required.
- Lifting bars for installation free of difficulty or risk
- Easy access for maintenance
- Refrigerant pump down operation

Maintenance Support

Diagnostics functions for troubleshooting

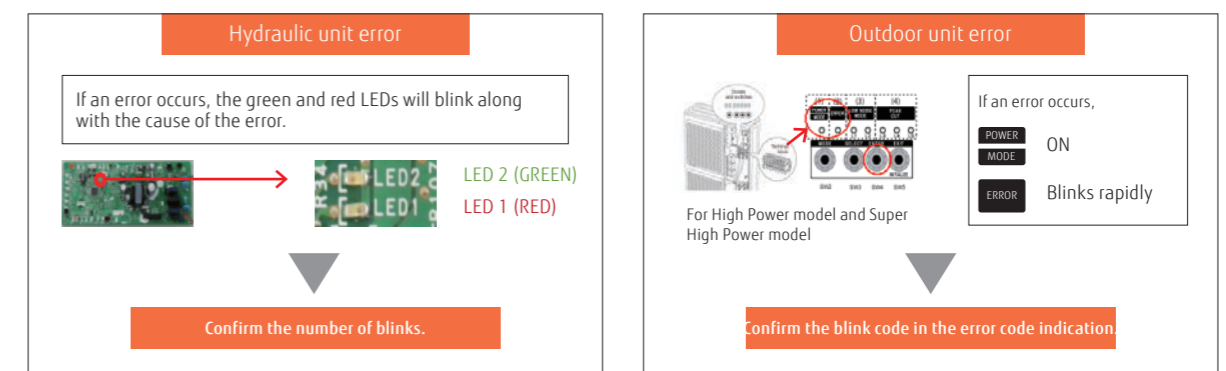
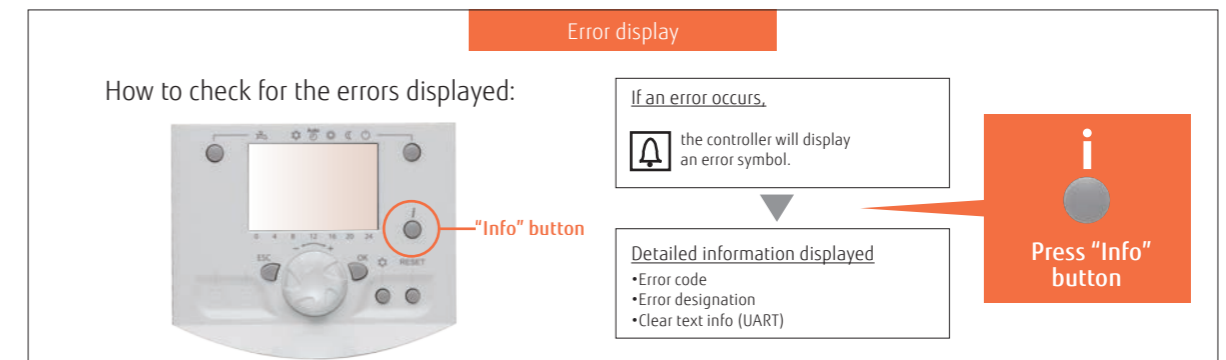

Check the error code table

Installation requirements

Installation of equipment & electrical wiring

Split type Hydraulic unit

- The Hydraulic unit is hung on the wall.
- Weight ≤ 88 kg (including water)
- Space for maintenance needs to be taken into consideration.

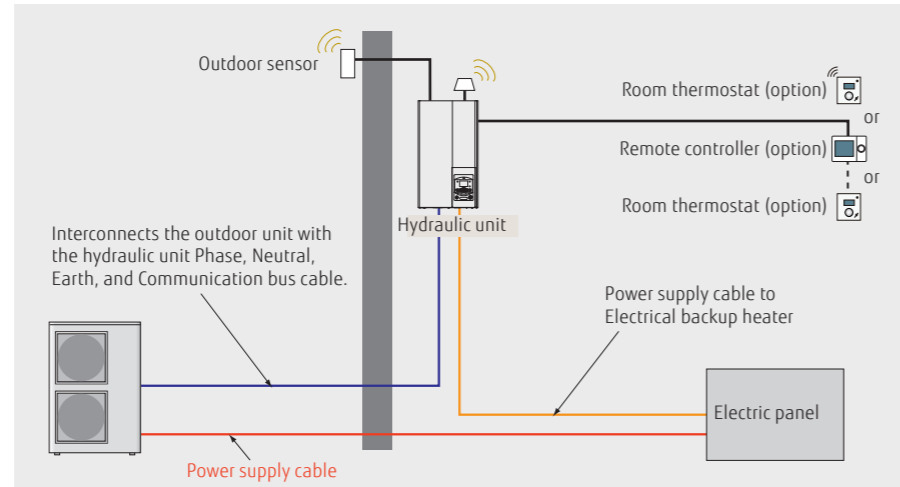
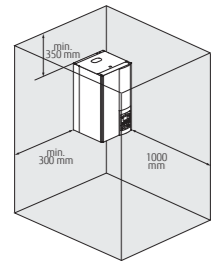

Split DHW Integrated Type Hydraulic Unit

- Floor standing
- Weight ≤ 393 kg (including water)
- Space for maintenance needs to be taken into consideration.

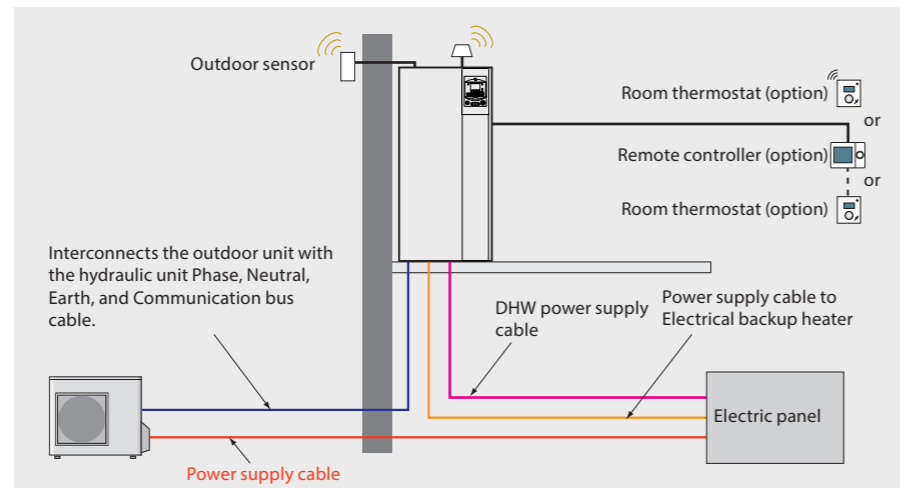
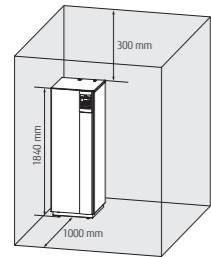

Piping and Wiring split type

Series	Capacity range (kW)	Pipe diameter (Liquid/Gas) (mm)	H1 (m)	H2 (m)	L (m)
R32 Comfort	5	6.35/12.70	+20	-20	3-30
	6				
	8				
High Power	10	9.52/15.88	+15	-15	5-20
	11				
	14				
Super High Power	16	9.52/15.88	+15	-25	5-30

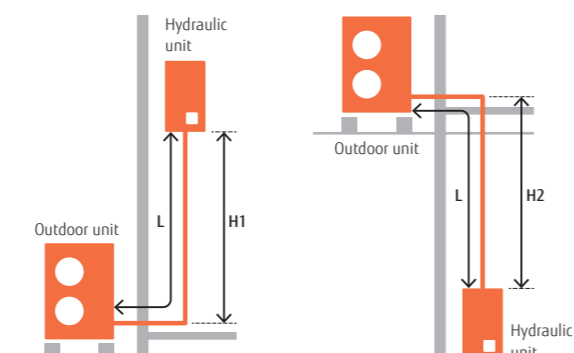

System Configuration

Split Type

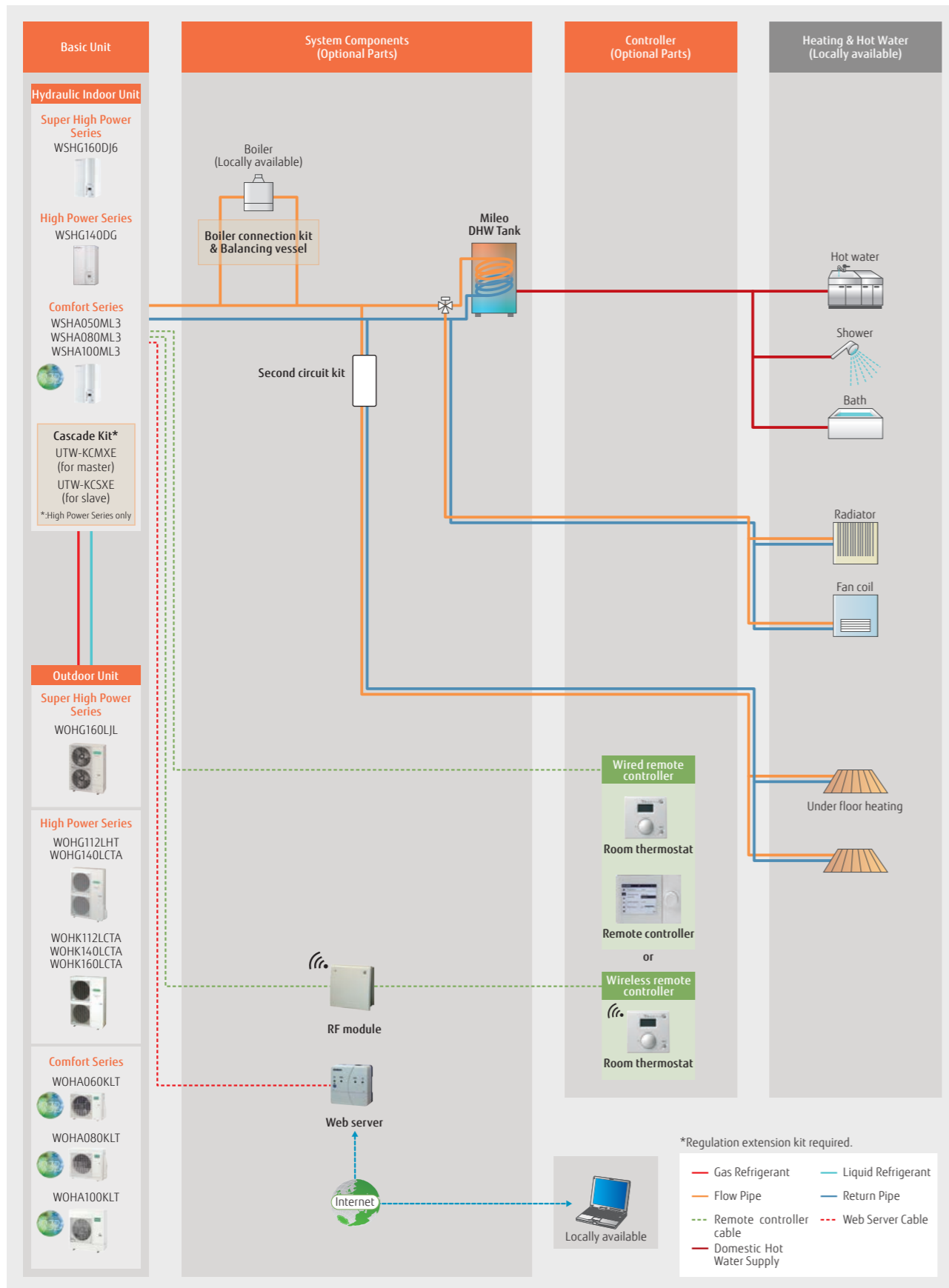

Split DHW Integrated Type

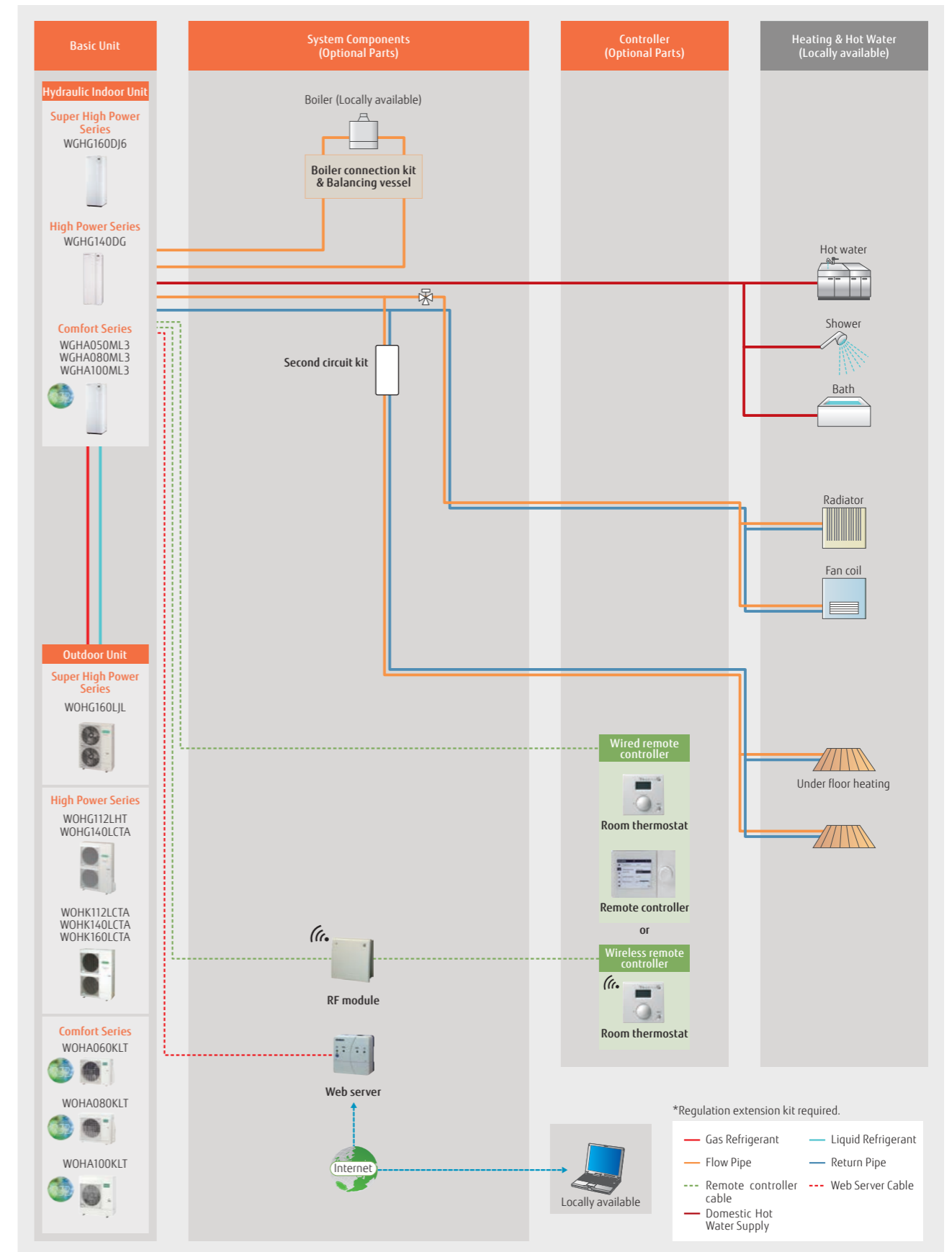

Case Studies

Split Type

2-emitter simultaneous heating (Individual control)
Underfloor heating + Radiator

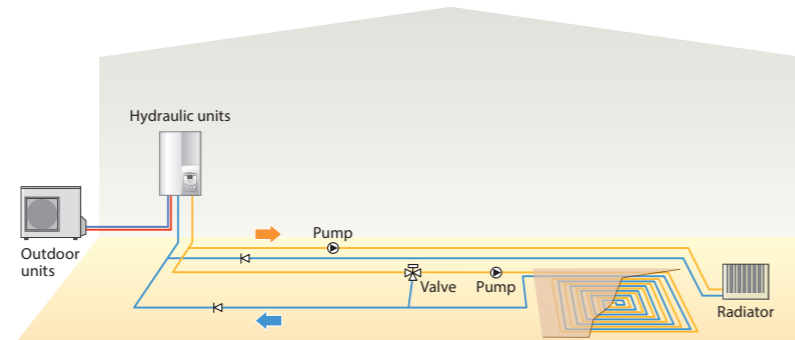

Boiler connected to heating (Boiler + Heating)

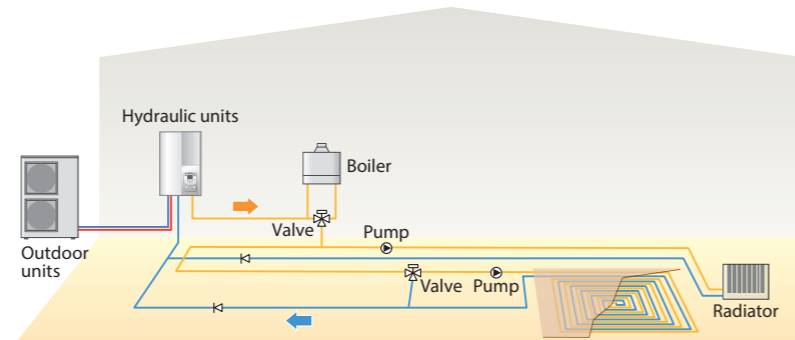

2-emitter simultaneous heating & domestic hot water supply (Cascade)

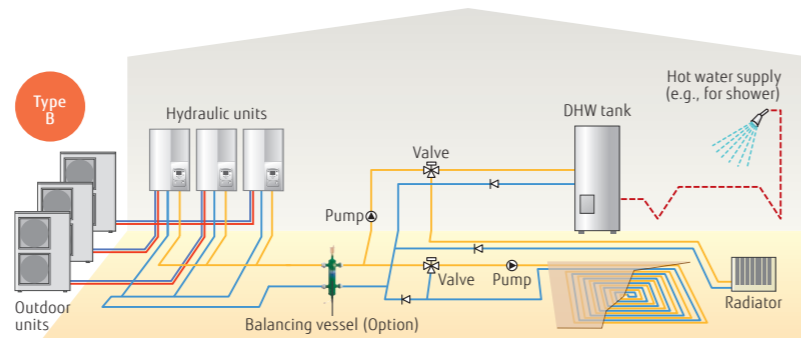
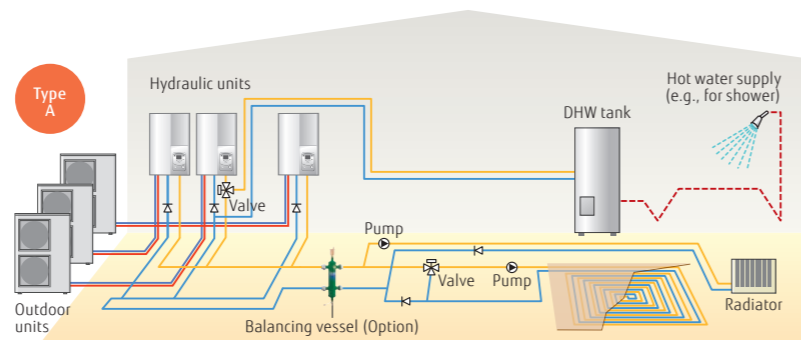

*The hydraulic layouts shown are mainly representation. Please check with local dealer for actual hydraulic connections.

Split DHW Integrated Type

Single heating & domestic hot water supply
Radiator + domestic hot water supply

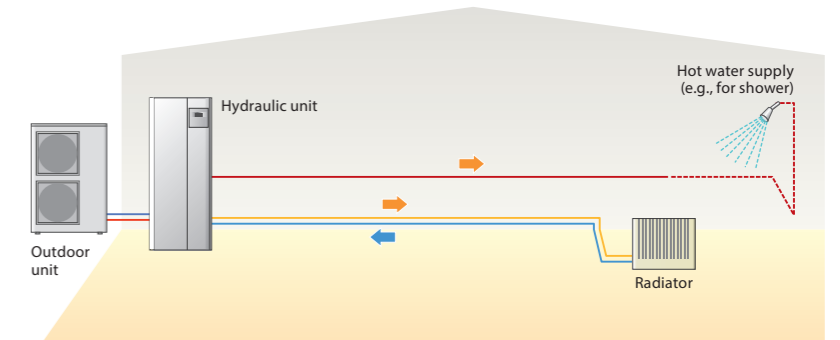

2-emitter simultaneous heating (Individual control) & domestic hot water supply
Radiator + domestic hot water supply

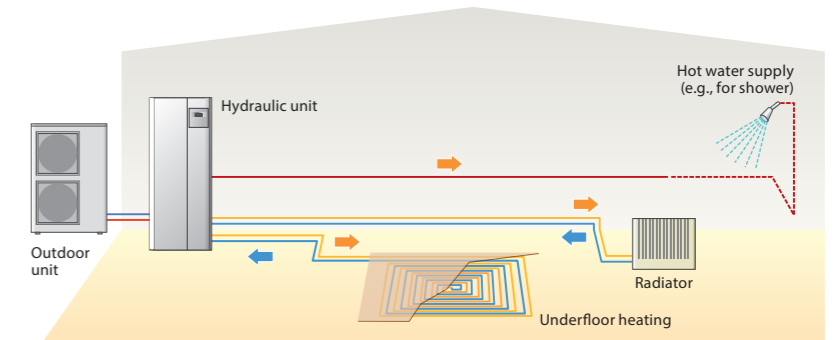

Boiler connected to heating (Boiler + Heating) and domestic hot water supply

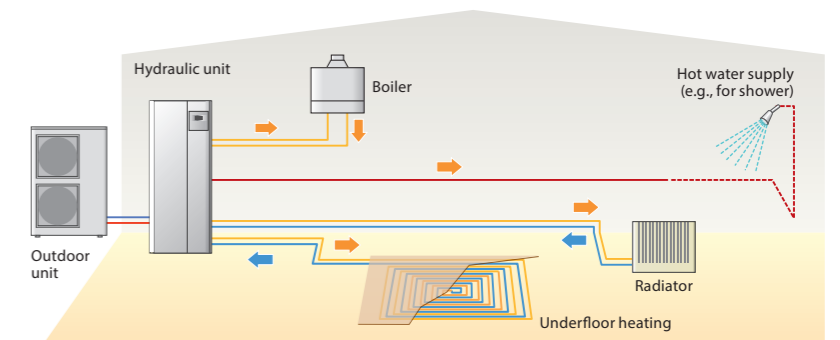

*The hydraulic layouts shown are mainly representation. Please check with local dealer for actual hydraulic connections.

Control Overview

To meet the diverse needs of customers, we offer a variety of control options, such as individual control and remote control options.

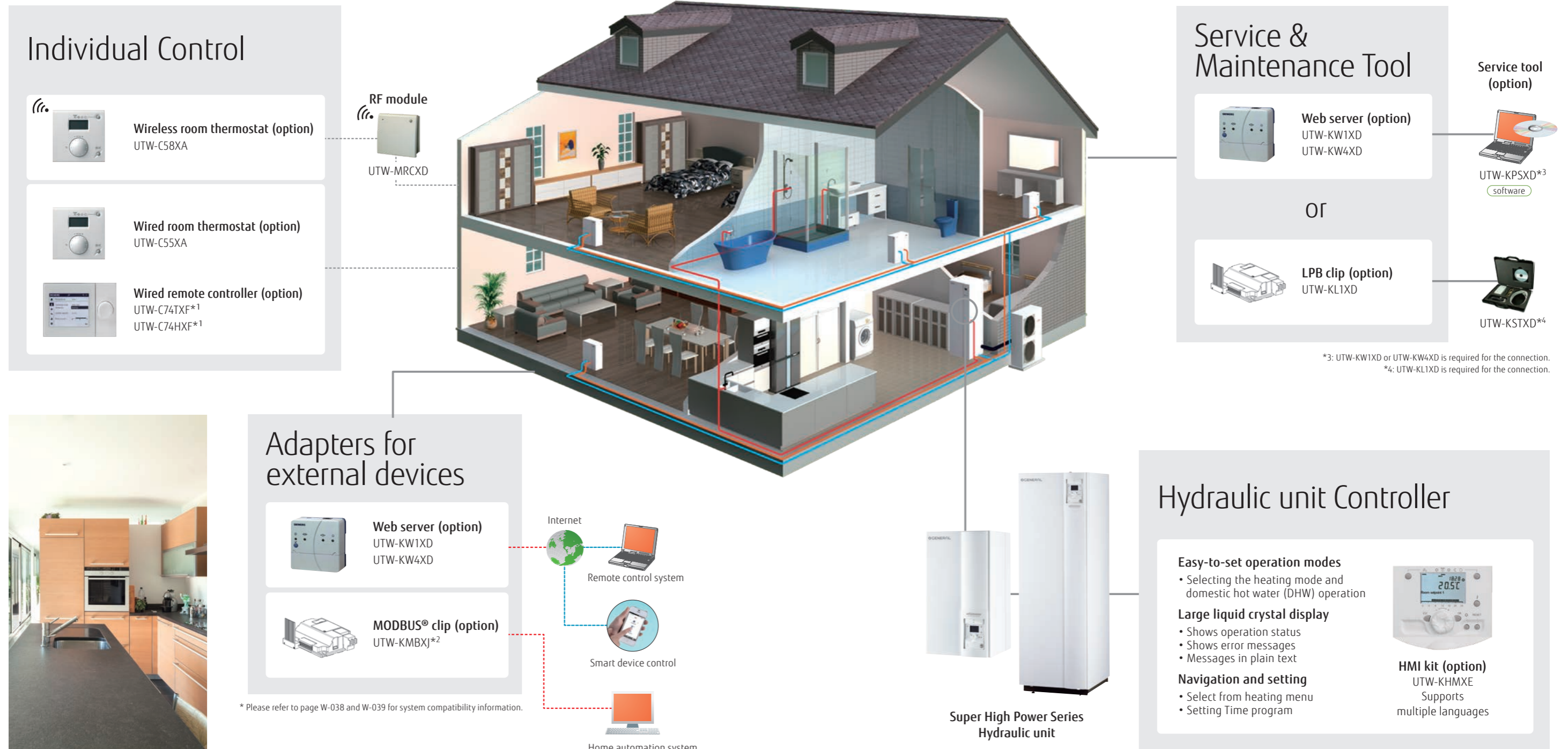

Optional Parts Overview

Various optional parts are available to use ATW according to needs and environments.



for Locally units



Second circuit Kit

It can supply hot water at different temperatures to each two types of heating equipment, such as radiators and underfloor heating.

UTW-KZSXE*¹



UTW-KZDXE*¹



UTW-KZSXJ



UTW-KZDXJ

Boiler connection kit

It can build hybrid systems using both boilers and heat pumps. Boiler and heat pumps are switched according to outside air temperature.



UTW-KBSXD



UTW-KBDXD



UTW-KBSXJ

*1: The UTW-KREXD (Regulation extension kit) is not included but is required for connection.



for Hydraulic unit



Circulating pump

UTW-PHFYG

The high-output pump for replacement of the standard pump in the hydraulic unit. It can be used in properties with longer and more complex water piping.

Cascade master/slave kit

Up to 3 hydraulic units can be connected for large-capacity use. It is need to install a primary kit in one unit and a secondary kit in one or two other units.



Cascade master kit (incl. LPB clip)



Cascade slave kit (incl. LPB clip)

Cooling kit

Required when using ATW also for cooling operation. It is used to prevent condensation occurring in the indoor unit.



UTW-KCLXD



UTW-KCLXL

Electrical backup heater relay



UTW-KBHL

It allows the backup heater for heating at 3 kW as standard can be used at 6 kW.

for DHW



DHW kit

UTW-KDWXD (External)

Required to connect locally purchased DHW tanks to air to water.



DHW tank

200 Liters: UTW-T20AXH / UTW-T20BXH

300 Liters: UTW-T30AXH / UTW-T30BXH

The BXH series is a more efficient tank than the AXH series.



UTW-KDEXE



UTW-KDEXL

DHW expansion kit

The expansion vessel(18L) for connection to DHW water piping.

for Outdoor unit



Drain pan

UTW-KDPXB

It is used to collect and drain condensation water generated by outdoor units.



External connect kit

UTY-XWZXZ2 / UTY-XWZXZ3

The signal input (low noise mode, peak cut) and signal output (compressor operation, base pan heater control) for outdoor units are possible externally.



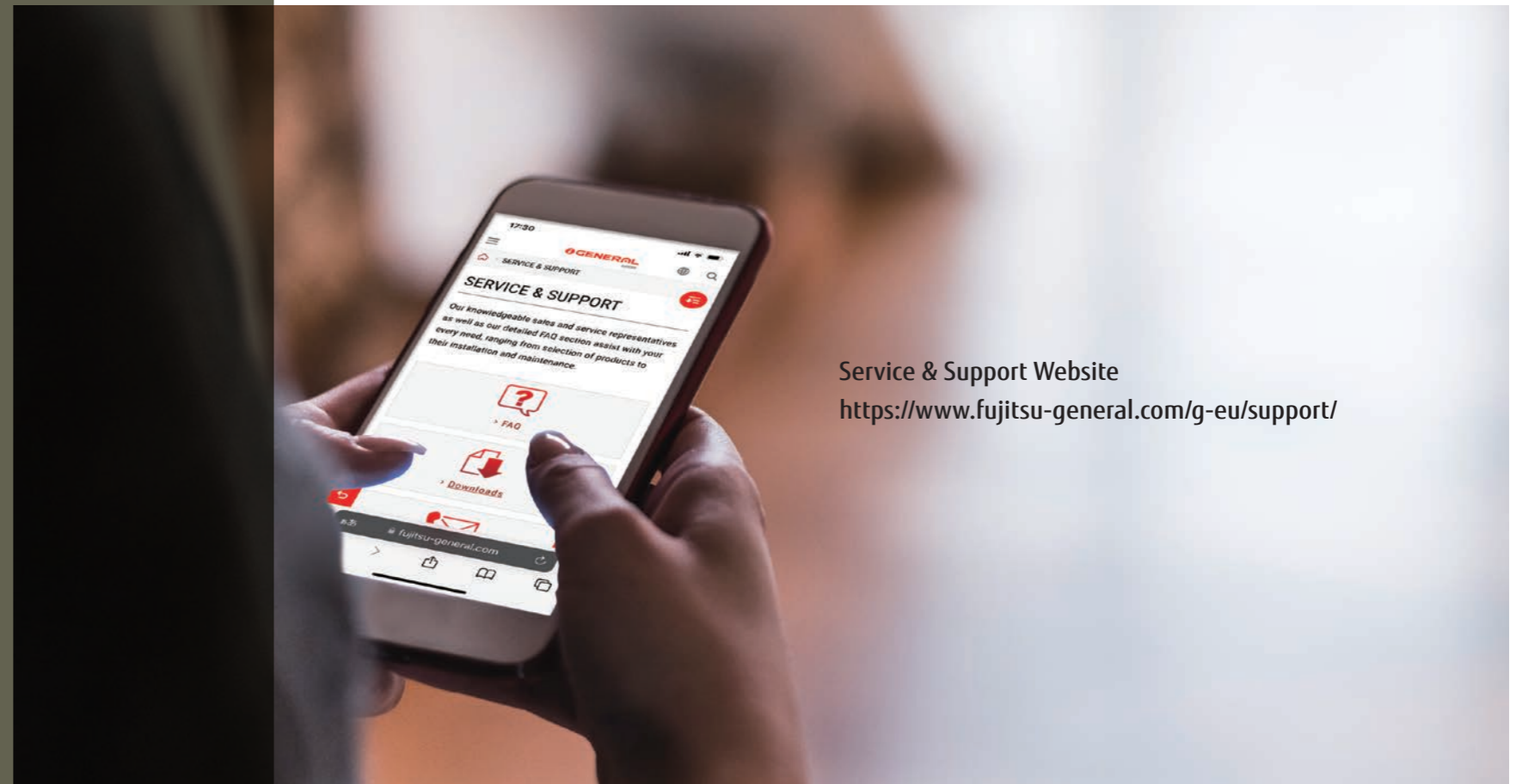

Service & Support Website
<https://www.fujitsu-general.com/g-eu/support/>

SUPPORT

- Sp-002 VRF Support
- Sp-004 HVAC system design Support Tool
- Sp-006 Air To Water Support Tool
- Sp-008 Quick Service & Maintenance
- Sp-010 Service monitoring tool
- Sp-012 Service Tool
- Sp-013 Web monitoring tool

Our knowledgeable sales and service representatives assist you, from product selection to installation and maintenance.

Category	Information material										Tool							
	Product sales training material	Product technical training material	Product news	Brochures	Promotional movies	Operation manuals	Design & Technical manuals	Certification data	2D CAD data	3D CAD (Revit) data	Installation manuals	Service manual	Air To Water Package label creator	Design simulator (Room air conditioner, Packaged air conditioner, and VRF)	Air To Water proposer	CFD simulation	Service tool and Web monitoring tool	Mobile technician
Product training	●	●																
Product information seeking			●	●	●	●	●											
Technical information seeking						●	●						●					
Model selection						●								●	●			
Design						●		●	●									
Verification																●		
Installation						●				●								
After-sales service												●					●	●

VRF Support

Fujitsu General provides engineers and consultants with a wide range of product and technical information. In addition, we conduct research on new products and support design activities. We provide a wide range of support services from design to installation to maintain high quality.



Training facilities

Technical information

We provide equipment selection software that facilitates the design of air conditioning systems by providing performance data for the units and estimation for model selection.

Features

- Design & Technical manuals
- Model selection & estimation
- Certification data
- 2D/3D CAD data

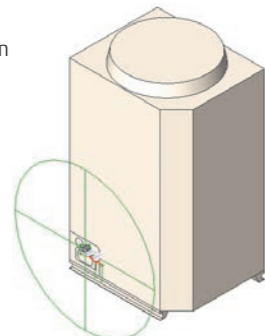

2D/3D CAD data

Technical support

Technical support is offered at every stage, from design through to installation, to assist in optimizing air conditioning solutions.

Features

- CFD simulation
- Guidelines
- Commissioning support

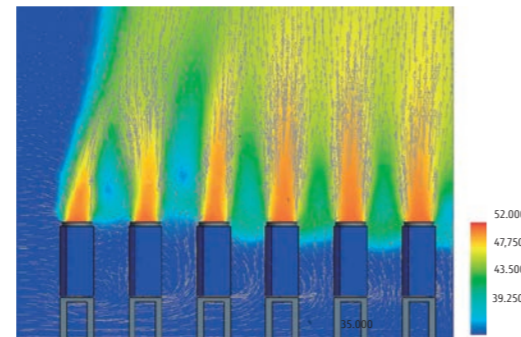

CFD simulation



Commissioning support

Product information

Information on new models is provided in the form of documents and movies in a timely manner for release, readily downloadable from the private section of our website. Contact your Fujitsu General representative for access information.

Features

- Product news
- Brochures & manuals
- Promotional movies

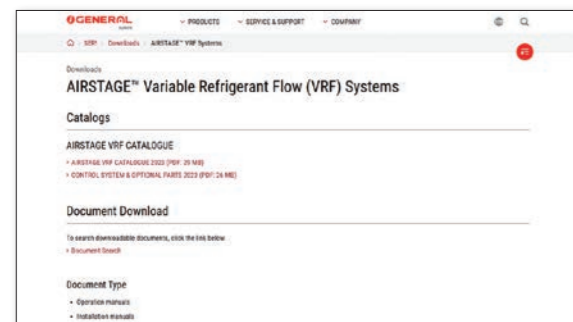

<https://www.fujitsu-general.com/g-eu/support/downloads/vrf/>



Fujitsu General regularly provides professional product, technical and service training at its training facilities worldwide. These research facilities also support the development of human resources with advanced technical skills.

Features

- Designing VRF systems
- On-site training for control systems

- 1 Head office training center in Japan
- 2 Training center in China
- 3 Asia training center in Singapore
- 4 Europe training center in the United Kingdom
- 5 Europe training center in Germany
- 6 America training center in the United States
- 7 Middle East training center in the UAE
- 8 Oceania training center in Australia

HVAC system design Support tool

Put the charts and pens away and design your projects on a computer using the Design simulator. Everything from selecting indoor and outdoor units, allocating controls and optional parts through to designing the piping and wiring systems is made easier using the program's built-in features. Once the project design is complete, the Export function makes it easy to generate material lists, product specifications, and refrigerant calculations, and more. You can also export in Word, Excel, and Acrobat formats, as well as group CAD data related to your project.



Design simulator

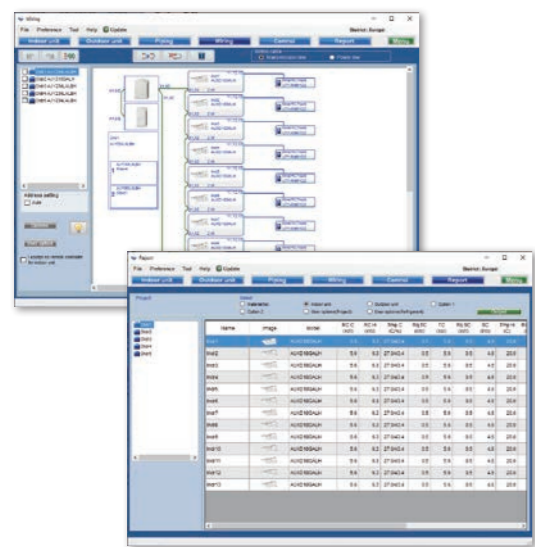

Outputs in the format that matches the application

You can export your project information in a number of industry standard file formats.

- Word format (rtf) (doc)
- Excel format (csv)
- Acrobat format (pdf)
- 2D CAD data (DXF)

Automatically create model selection information

- The required performance, type, and temperature conditions for each indoor unit are entered and then dragged and dropped onto the outdoor unit to automatically set each unit.
- Creates piping and wiring diagrams automatically to facilitate branching, grouping, and option settings.
- The additional refrigerant charging is automatically calculated when the pipe length is entered.
- Easy configuration of remote controller groups, central controller, and converters.
- The equipment list including the equipment information is created automatically.

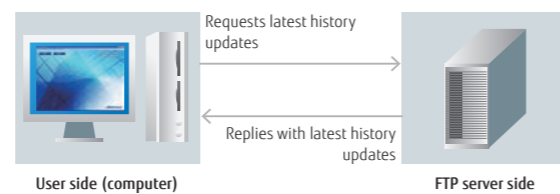

Update your Design simulator

The database can be updated easily online with the AutoUpdate function using FTP.

BIM Building information modeling



BIM files of Fujitsu General's products are available on BIMobject®

Fujitsu General is releasing BIM files of our products on the BIMobject® website BIMobject.com.

Outline of BIMobject®

BIMobject® is a game changer for the construction industry, offering development, maintenance, and syndication of objects on the world's largest BIM platform.

About BIM files

- BIM files can be viewed in Autodesk Revit® 2018 version or later.
- In each BIM file, the location of the connectors for the refrigerant and drain pipe is different.
- Each BIM file includes several family types.
- A catalog and specification sheet is available in Revit file format for each product.

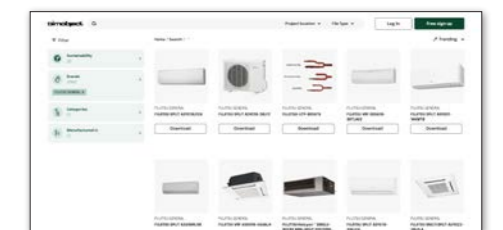
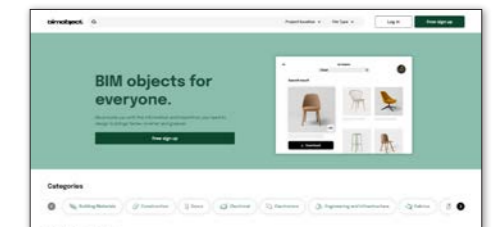

R RFA (Revit data)
A data format available for BIM-designed projects

A DWG
a standard data format used for Autodesk products

Data content

- Shape (Size)
- Drain direction
- Pipe direction
- Power supply location
- It contains information about the above specifications.



DXF

Intermediate data commonly available in CAD products

- Data content**
- Shape (Size)

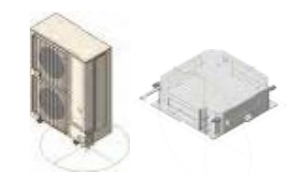

*To learn more about how to use BIM files, refer to the instructional video on each product page. youtu.be/wfL-hwFQ7dM

Air To Water (ATW) Support tool

Fujitsu General's software for ATW automatically creates a combination of ATW equipment by simply providing a few parameters. Supports multiple languages with an automatic update function.

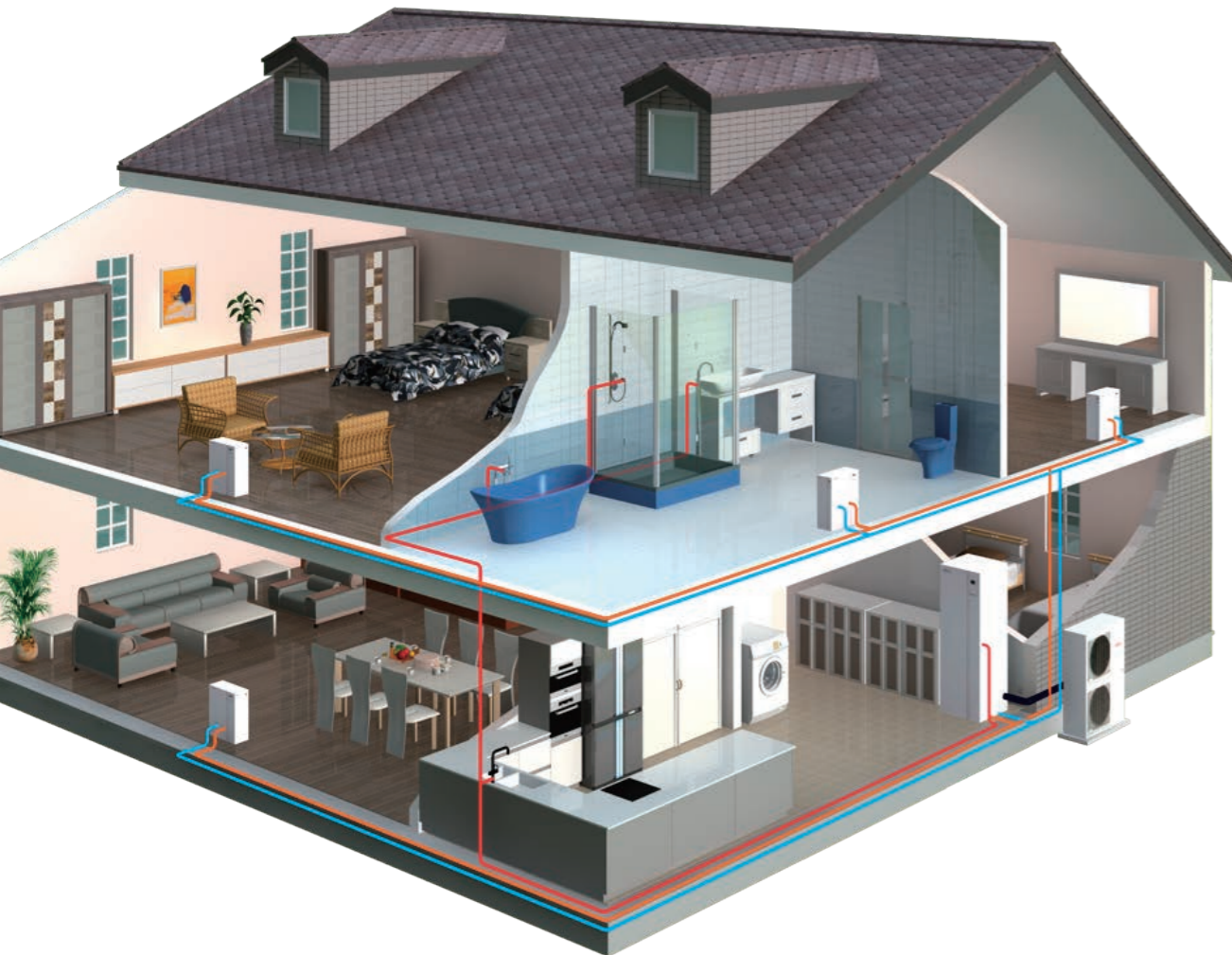
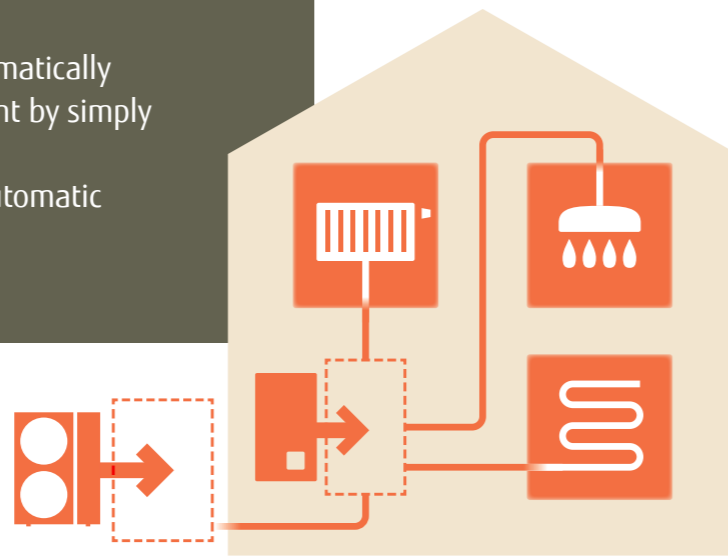

Air To Water proposer

Selecting models with detailed technical information

- Simply enter the region where the equipment will be installed, the required heating capacity, the method of heating and other factors, and the software will select the appropriate equipment automatically.

* From now on, the name will be changed to the new name above.
The current name is WATERSTAGE Proposer.

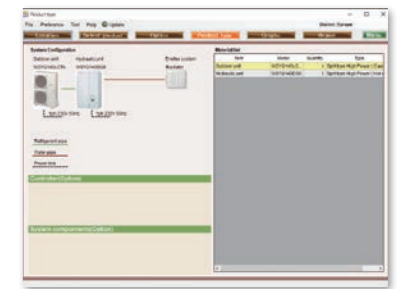

The images of the optional items will help you configure your system correctly. If more than one ATW equipment is required, all relevant option items will be selected automatically.

The selected unit can be modified after reviewing the overall system configuration. The images and the list of devices are displayed at the same time, helping to avoid mistakes in device selection.

Air To Water Package label creator

Download Energy labels and Fiches from our website

ErP documents such as Energy labels, Product fiches, Package labels, Package lists, Information sheets, and EC Declarations can be searched for and downloaded from our website.

We will also provide an online service in the future so that installers can easily create various package labels and package fiches for different models.

* From now on, the name will be changed to the new name above.
The current name is WATERSTAGE Package label creator.

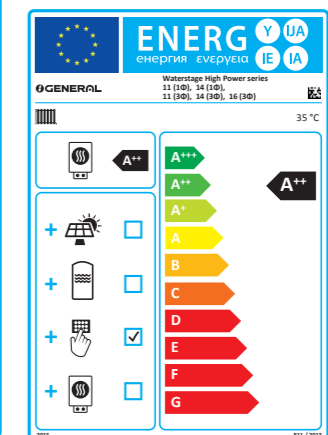
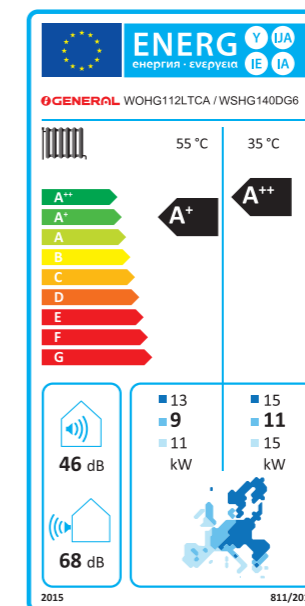

Quick service & maintenance

In the unlikely event that a problem should occur with the unit or system, a wide variety of support tools are available to assist with prompt service and maintenance anytime, anywhere, including error code displays on the product, service tools to check the detailed status of the entire system, and remote monitoring tools using the internet.



Easy maintenance & monitoring

Designed for easy maintenance

The operating status of the air conditioner and detailed trouble conditions are displayed on the 7-segment indicator lamp on the outdoor unit printed circuit board (PCB) and on the screen of the remote controller. Check the status of the unit quickly for a prompt response.

- Display the operation mode at the time.
- Discharge temperature and pressure
- Compressor operation status
- "Address/Type/Number" of the outdoor unit
- Error code

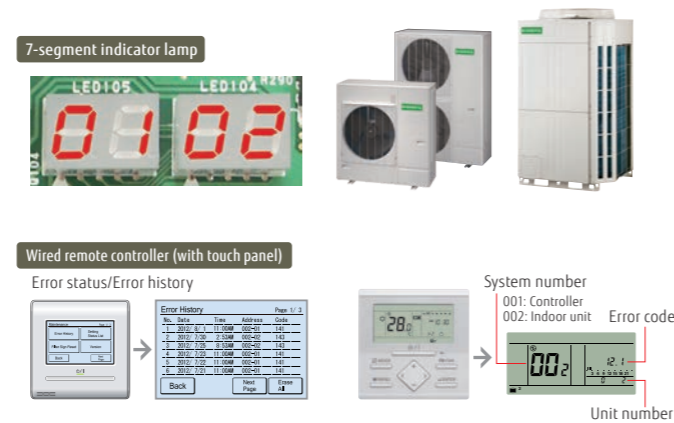

Error diagnosis by Service tool

Connect Service tool to check the status details of units, from single split to VRF, on a computer screen. Check the errors quickly for prompt countermeasures.

- Operating status/control
- Monitoring operating conditions
- Monitoring sensor data
- Indicating trend graphs
- Error history
- Indicating refrigerant circuit diagrams (for VRF)

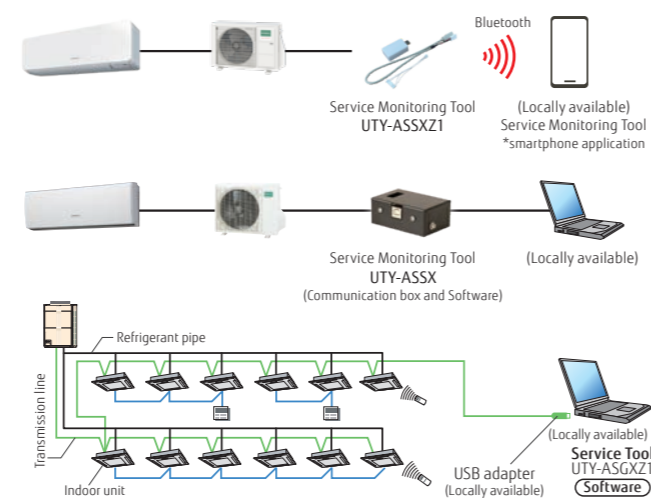

Remote monitoring

VRF system operating status and trouble status details can be monitored remotely at any time via the internet. Prompt coordination is available with service personnel.

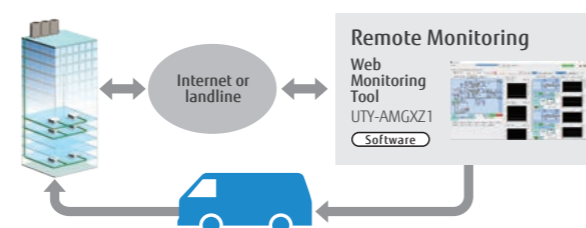

Mobile troubleshooting App for iOS and Android™ devices

We will release an App for troubleshooting tools for iPhone, iPod touch and other Apple devices, and Android products for Fujitsu General air conditioners (Room air conditioner/ Packaged air conditioners VRF and ATW, "AIRSTAGE Mobile", and R32 calculation of allowable refrigerant capacity)

Use Error Code Check, Troubleshooting, and Sensor Check to understand the status of your air conditioner.

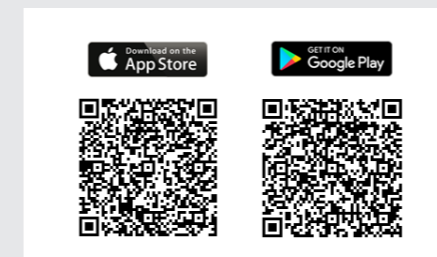

Service monitoring tool for Single split, Multi-split & Air to water



- A quick overview of the temperature sensor readings and the electronic expansion valves (EEVs), fans, compressors and other control components
- It is not always easy to read the temperature sensor and know the status of the control components. So let the Service monitoring tool judge them.
- Visualizes protected operations
- Troubleshoots intermittent problems effectively
- Provides proof of normal operation to customers during periodical maintenance

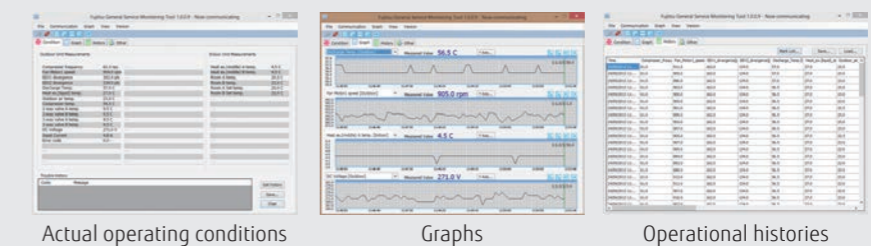

	UTY-ASSX
Dimensions (H × W × D) (mm)	60 × 160 × 160
Weight (g)	500

NEW **AIRSTAGE Service Monitor Tool** for Single-split, Multi-split, Air to water
UTY-ASSXZ1

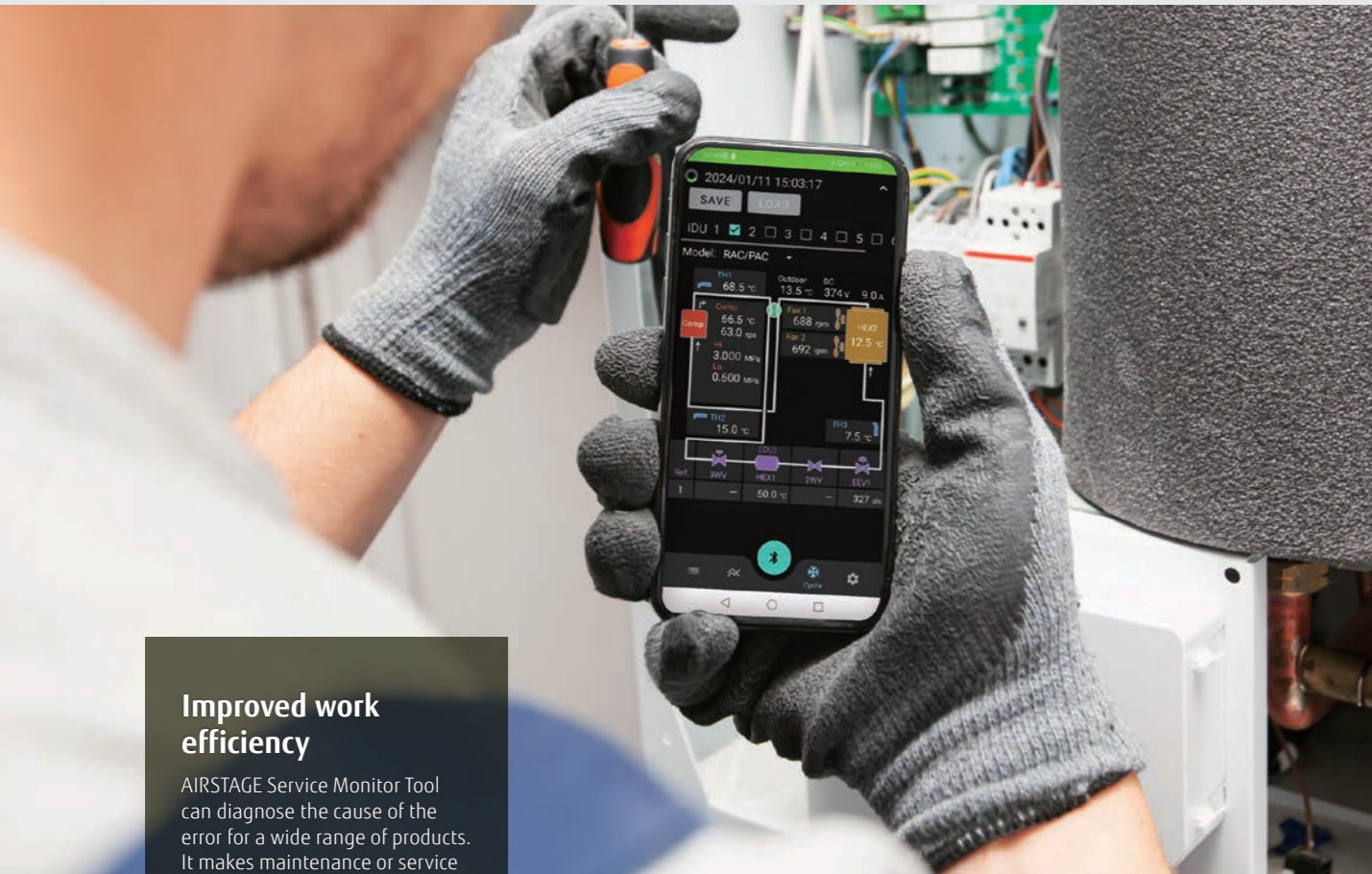

Improved work efficiency

AIRSTAGE Service Monitor Tool can diagnose the cause of the error for a wide range of products. It makes maintenance or service support faster and can also reduce the number of visits and maintenance costs.

*The values in the pictures are examples.

Bluetooth communication

AIRSTAGE Service Monitor Tool can diagnose by the smart device*1 and reduce the working time compared with diagnosis by PC. No need to connect a PC makes diagnosis easier even in narrow spaces.

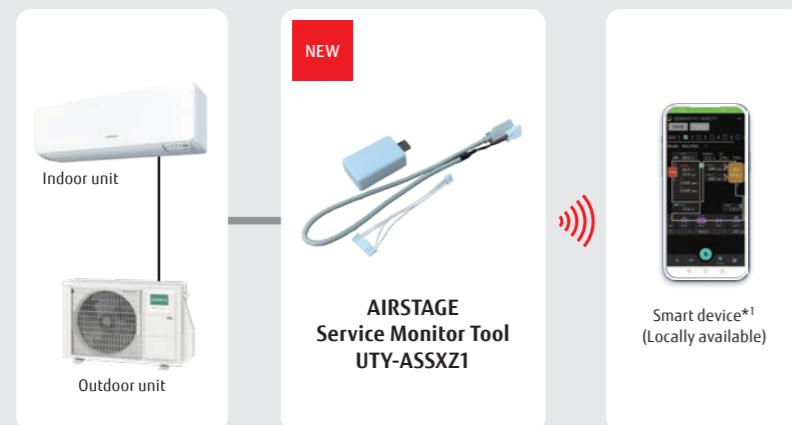

*1 Android only.
You need to install the "AIRSTAGE Service Monitor Tool" app on your smart device.

Compact and lightweight design

New model is easy to carry by compact and lightweight design. The service personnel can visit the maintenance site with small luggage.



New application with simple design

New application for smart devices has been released. The stylish design makes the application easy to use for everyone.



AIRSTAGE Service Monitor Tool



Refrigerant cycle diagram display

The operating status can be displayed with a simple, clear diagram*2 on the smart device. It reduces the time for diagnosis and makes diagnosis easier. It can complement abundant experience and advanced knowledge of refrigerant cycle. This shortens the training time for service personnel.

*2 list and graph displays are also available

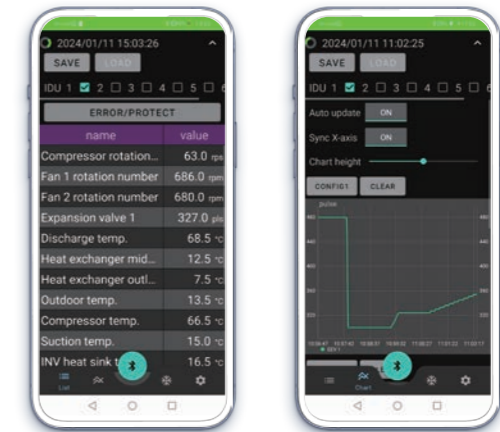

*The values in the pictures are examples.

Specifications

	UTY-ASSXZ1
Dimensions (H x W x D) (mm)	20 x 35 x 60 (adapter)
Communication cable (cm)	60
Weight (g)	25 (adapter)
Communication method	Bluetooth 5.3
Max. communication distance (m)	10*3
Compatible device	Android8.0 or above

*3 Depends on the environment

Function List

		UTY-ASSXZ1	UTY-ASSX
Product specification	Installation	Outdoor unit PCB	Outdoor unit PCB
	Communication	Bluetooth	Wired
Support product type	Split	●	●
	Multi-split	●	●
	ATW	●	●
	VRF	—	—
	Product distinction	●	●
Function	Signal-type distinction	●	●
	Operating status display	List	●
		Graph	●
		Refrigerant cycle diagram	●
Adapter firmware update	●	—	
Adapter status monitoring	●	—	
Input and output of history data	●	●	

Service tool

UTY-ASGXZ1

Extensive monitoring and analysis functions that make installation and maintenance easier

- The operation status of the system can be monitored and analyzed to detect any malfunctions.
- Data on the operation status of the system can be stored on a computer to allow for remote access.
- Up to 400 indoor units in a single VRF network system can be controlled and monitored for a large building or hotel.
- This software can be connected to any point of transmission line with a USB adapter (locally available).

* Saved data can be displayed offline. Note that the data saved by the following software applications cannot be displayed.

- UTR-YSTB/UTR-YSTC (Service tool)
- UTR-YMSA (Web monitoring tool)

Automatic operation check for refrigeration cycles

Once installed, the Service tool automatically checks for refrigeration cycles. The self-diagnosis function determines whether each sensor value is normal, which reduces the need for manual checks. The result of a diagnosis can be provided in a report.

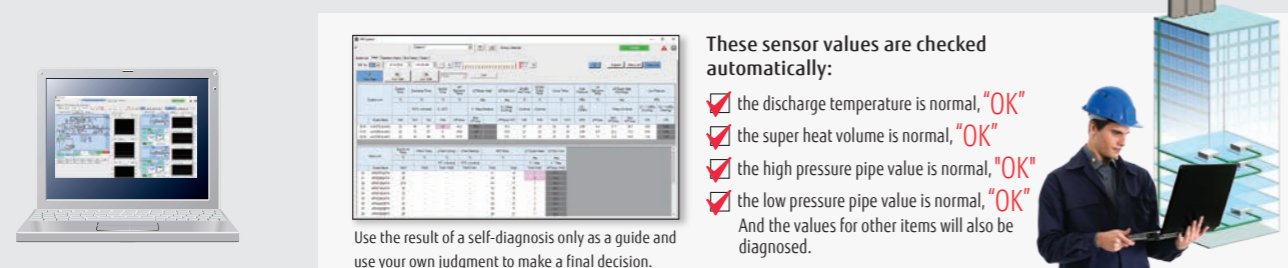

Use the result of a self-diagnosis only as a guide and use your own judgment to make a final decision.

These sensor values are checked automatically:

- ✓ the discharge temperature is normal, "OK"
- ✓ the super heat volume is normal, "OK"
- ✓ the high pressure pipe value is normal, "OK"
- ✓ the low pressure pipe value is normal, "OK"

And the values for other items will also be diagnosed.

Remote technical support and maintenance

On-site check screen can be shared between on-site staff and a service technician in a remote location. When a service technician visits the site for troubleshooting, the system's operation status can be shared in real time with a remote service center for assistance. On-site staff can have an online chat with a remote service center to get further assistance.

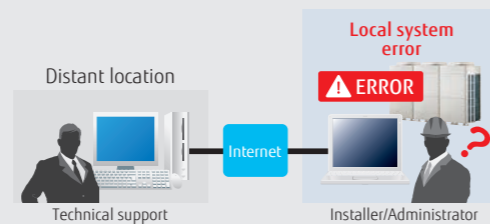

Trend charts

Previous-generation application could display only 3 sets of data from sensors. However, the current generation of the service tool displays multiple charts simultaneously so that refrigeration cycles can be monitored and checked in greater detail.



Computer requirements

UTY-ASGXZ1	
Operating system	• Microsoft® Windows® 7 Professional (32-bit or 64-bit) SP1 • Microsoft® Windows® 8.1 Pro (32-bit or 64-bit) • Microsoft® Windows® 10 Pro (32-bit or 64-bit)
CPU	1 GHz or higher
Memory	• 1 GB or more (for Windows® 7 [32-bit], Windows® 8.1 [32-bit], and Windows® 10 [32-bit]) • 2 GB or more (for Windows® 7 [64-bit], Windows® 8.1 [64-bit], and Windows® 10 [64-bit])
HDD	40 GB or more of free space
Screen resolution	1366 × 768 pixels or higher
Interface	• USB port for U10 USB Network interface and software protection key
Software	Internet Explorer® 11 or Microsoft Edge

Packing list

Name	Quantity	Application
White-USB-key (Software protection key)	1	Software protection key to be connected to a USB port on a Service tool-installed computer. This software runs only on a computer with WibuKey.

*Computer requirements
•Echelon® U10 USB Network Interface – TP/FT-10 Channel (Model name: 75010R) (Required for each VRF Network)

Web monitoring tool

UTY-AMGXZ1

Features

- Troubleshooting is performed by monitoring each air conditioning unit remotely during a periodical system check.
- An error notification is automatically transmitted to several locations via the internet*1.
- Requires either a dedicated internet connection or landline to operate.
- The occurrence of an error can be confirmed through an error alert and equipment status information obtained from a remote location.
- Monitoring data can be downloaded in a remote location. These data can be accessed and displayed even when the service tool is in offline mode.
- Can be viewed on the monitoring computer's Web browser without installing any special software.

*1: Internet e-mail access required.

Web Monitoring System

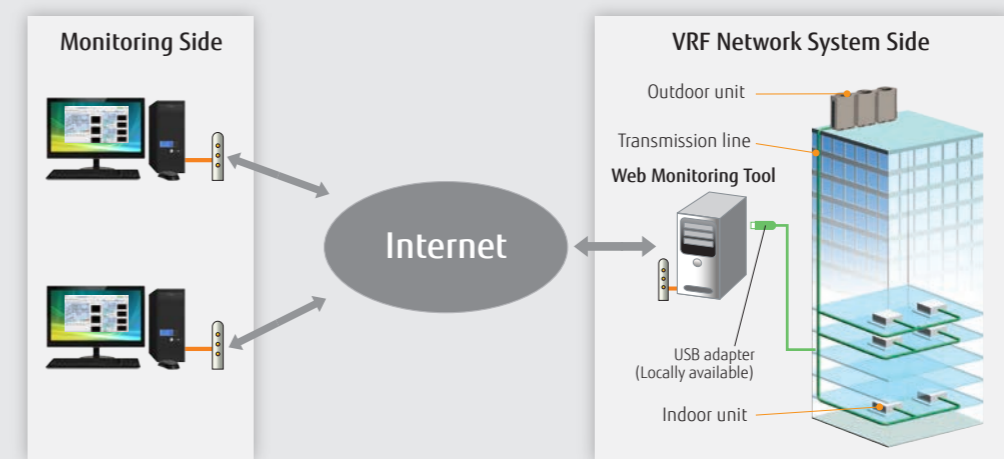

Supporting up to 4 VRF network systems

Up to 4 USB adapters can be connected to a computer, enabling the monitoring of up to 1,600 indoor units.

Suitable for use in a large building or hotel.

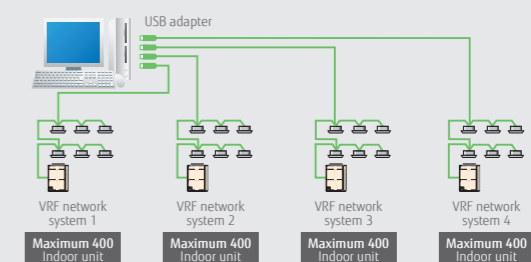

Computer requirements

UTY-AMGXZ1	
Operating system	• Microsoft® Windows® 7 Professional (32-bit or 64-bit) SP1 • Microsoft® Windows® 8.1 Pro (32-bit or 64-bit) • Microsoft® Windows® 10 Pro (32-bit or 64-bit)
CPU	1 GHz or higher
Memory	• 1 GB or more (for Windows® 7 [32-bit], Windows® 8.1 [32-bit], and Windows® 10 [32-bit]) • 2 GB or more (for Windows® 7 [64-bit], Windows® 8.1 [64-bit], and Windows® 10 [64-bit])
HDD	40 GB or more of free space
Screen resolution	1366 × 768 pixels or higher
Interface	• USB ports (one for U10 USB Network interface and up to 4 ports for software protection keys) • Interface for remote connection: - Landline: Modem is required. - Internet using LAN: Ethernet port is required.
Software	Internet Explorer® 11 or Microsoft Edge

Packing list

Name	Quantity	Application
White-USB-key (Software protection key)	1	Software protection key to be connected to a USB port on a Service tool-installed computer. This software runs only on a computer with WibuKey.

*Computer requirements
•Echelon® U10 USB Network Interface – TP/FT-10 Channel (Model name: 75010R) (Required for each VRF Network)