

PRODUCT CATALOGUE 2023

AIR CONDITIONERS LINEUP

Notice regarding specifications

I.U. = Indoor Unit O.U. = Outdoor Unit Qu = Quiet * = Not decided yet

- Specifications and design are subject to change without notice for future improvement.
- For further details, check with our authorized dealers.
- Cooling and heating capacities are based on the following conditions:

Cooling	Indoor temp. : 27°C DB/19°C WB Outdoor temp.: 35°C DB/24°C WB	Heating	Indoor temp. : 20°C DB Outdoor temp.: 7°C DB/6°C WB
---------	--	---------	--

- Performance tests are conducted in accordance with EN14511.
- Seasonal efficiency tests are conducted in accordance with EN14825.
- Sound power tests are conducted in accordance with EN12102.



Fujitsu General (Thailand) Co., Ltd.



ISO 9001 Certification number: 01 100 075229
ISO 14001 Certification number: 01 104 9245

Fujitsu General (Shanghai) Co., Ltd.



ISO 9001 Certification number: 01 100 79269
ISO 14001 Certification number: CNBJ312244-UK

Fujitsu General Central Air-conditioner (Wuxi) Co., Ltd.



ISO 9001 Certification number: 15917020073R5M
ISO 14001 Certification number: 15918E20021R5M

- The products and equipment listed in this catalog contain fluorinated greenhouse gases.
- **GENERAL**, **AIRSTAGE** and **WATERSTAGE** are worldwide trademarks of Fujitsu General Limited, and are registered trademarks in Japan and other countries and regions.
- iPhone and iPod touch are trademarks of Apple Inc., registered in the United States and other countries.
- Microsoft, "Windows," and "Direct X" are trademarks of Microsoft Corporation in the United States and other countries.
- "Intesis" is a registered trademark of HMS Industrial Networks in the European Union and is trademarked in the rest of the world.
- "IntesisHome" is a registered trademark of Intesis Software S.L.
- "BACnet" is a trademark and registered trademark of the American Society of Heating, Refrigerating and Air-Conditioning Engineers, Inc.
- "MODBUS" is a registered trademark of Schneider Electric.
- "LONWORKS" and "Echelon" are trademarks of Echelon Corporation registered in the United States and other countries.
- "Adobe" and "Acrobat Reader" are either registered trademarks or trademarks of Adobe in the United States and/or other countries.
- "Android" is a trademark of Google LLC.
- Other company and product names mentioned in this document may be the registered trademarks, trademarks or trade names of their respective owners.
- **FCair** is a worldwide trademark of Fujitsu General Limited.

Distributed by:

FUJITSU GENERAL LIMITED

3-3-17, Suenaga, Takatsu-ku, Kawasaki, Kanagawa, 213-8502, Japan
www.fujitsu-general.com/g-global/



Copyright© 2008-2023 Fujitsu General Limited. All rights reserved. 3EG035-2308E

FUJITSU GENERAL LIMITED

The FUJITSU GENERAL Way

Our mission

Living together for our future

Through innovation and technology, we deliver a brighter future with peace of mind to our customers and societies around the world.

Our philosophy

Act spontaneously

We embrace new challenges by investing in ourselves for personal growth, and through continuous creativity with a spontaneous attitude.

Develop our team

We respect and value our people, and optimize their abilities through fostering culture and diversity, and utilizing a collaborative effort focused on communication.

Value integrity

To achieve our goals, we always act with integrity and shared ethics.

CONTENTS

004 1000000000years from now.

006 OUR MESSAGE

008 Sustainable

010 Cleanliness

012 Future

014 Comfort

016 Control

018 Design

020 History

022 Worldwide locations

024 Global business activities

026 Project references

028 Global development & Production bases

030 High-quality development & Production Facilities

032 2023 New Products

036 SOLUTIONS

038 For Light Commercial Use

046 For Commercial Use

048 For Apartments & Houses

PRODUCT LINEUP

SPLIT & MULTI-SPLIT

VRF

VENTILATION

CONTROL SYSTEM & OPTIONAL PARTS

AIR TO WATER

SUPPORT

Sp-002 AIRSTAGE Support

Sp-004 HVAC System design Support Tool

Sp-006 WATERSTAGE Support Tool

Sp-008 Quick Service & Maintenance

Sp-010 Service Tool

Sp-011 Web Monitoring Tool

1000000000 years from now.

~ Children smiling under a pleasant blue sky long into the future, a billion years from now ~

We continue to change to sustain a cleaner world.

Air conditioners are now an essential lifeline to 'life'.

Guidelines aimed at achieving a comfortable, healthy, safe, and secure society through manufacturing that is friendly to people and the earth.



OUR MESSAGE



for Sustainable



for Cleanliness



for Future

**Innovation
and
Globalization**



for Comfort



for Control



for Design

We create comfortable lives for people around the world with "made-in-Japan quality" and innovative manufacturing.



History



Worldwide locations



Global business activities



Project references



Global development & Production bases



High-quality development & Production facilities



Sustainable



Sustainable management

We see the challenge of expanding our business by contributing to the realization of a sustainable society as a core element of our growth strategy, and we are working on "sustainable management," based on the three pillars of "harmonious coexistence with our planet," "social contribution," and "care for employees."

Basic policy on sustainable management

The sustainable development goals (SDGs) of the UN will drive business creation in the coming years. The key principle of the SDGs, "Leave no one behind," is synonymous with our own corporate philosophy of "Living together for our future." The promotion of sustainable management is carried out from a medium- to long-term perspective, with a promise to shape a sustainable society for the children and society of the future. We will pursue business growth by accelerating this transformation.

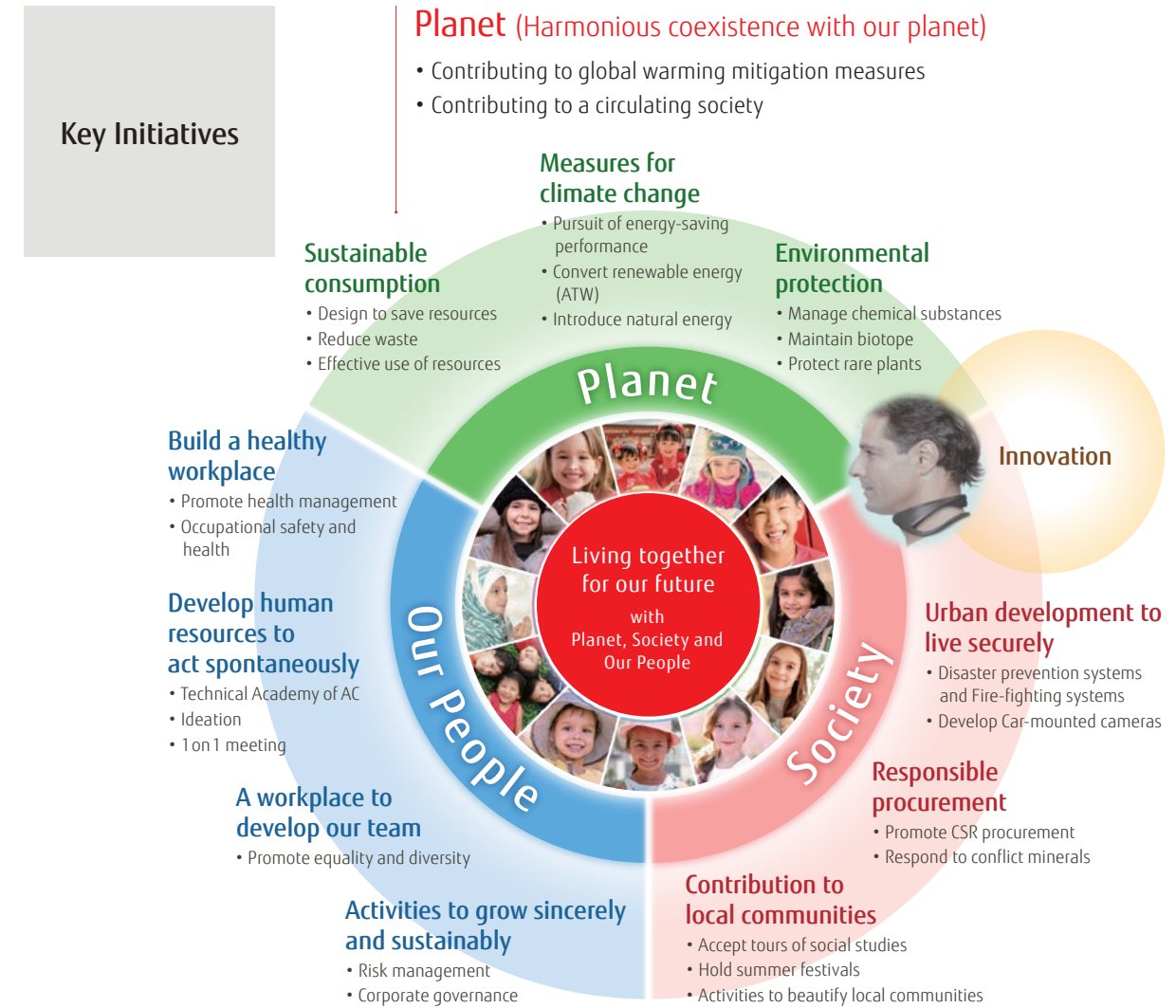

Our People (Care for employees)

- Strategic implementation of health and productivity management
- Creating flexible work styles under COVID-19
- Enhancing human resource development

Society (Social contribution)

Fostering innovation to address social issues (Providing a healthy, clean, and safe society and environment)



Cleanliness



Think about air quality

Fresh air is essential for comfortable air conditioning. Fujitsu General offers a wide range of air conditioning products with air purification functions, such as ventilation systems equipped with high-performance filters and heat exchangers.

Collecting dust particles to clean the air



Silver Ion Filter

The Silver ion filter helps to keep indoor air free from viruses, bacteria and molds. Notice: Not a result of experiments in an actual use environment. Silver ion filter inhibits activity or growth of microorganism, but do not prevent infection.

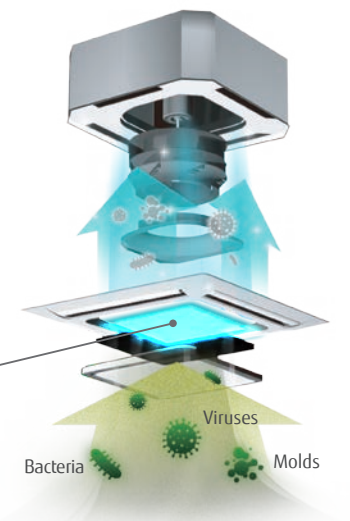
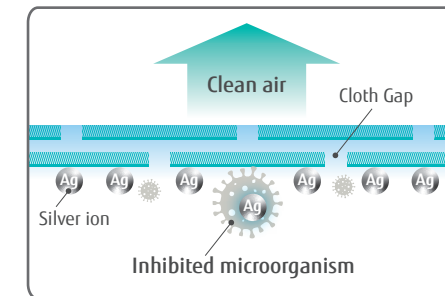

Different filters are used on each side



Ion Deodorization Filter

Deodorizes the air by decomposing absorbed odors using the oxidizing and odor-reducing effects of ions generated by ultra-fine particle ceramic.

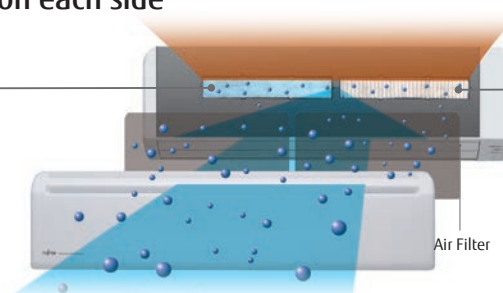

Apple-catechin Filter

The Apple-catechin filter uses static electricity to remove fine particles and dust from the air.

Ventilation with adequate airflow with reduced temperature changes

Heat Exchange Ventilation

When a room is cooled or heated, the exhausted cooling or heating energy is recovered by heat exchange ventilation.



Adopts a high-efficiency counterflow heat exchange element

Air handling unit

The Air handling units connected to Fujitsu General's VRF system are equipped with technology that provides high energy efficiency and superior comfort to meet the most stringent air conditioning requirements and installation conditions.

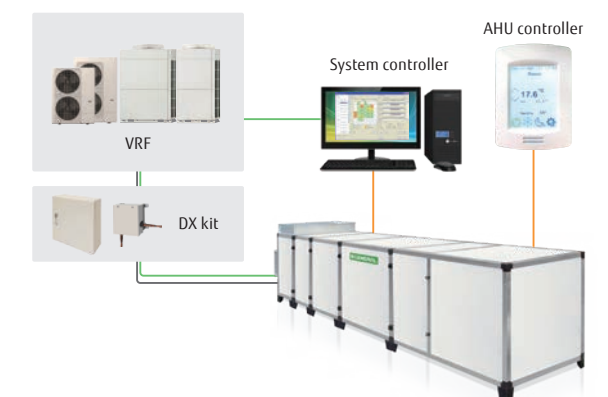



The green refrigerant

Throughout our research and development process, we are constantly striving to create products that we can be proud of in the future. The technologies we have cultivated through these efforts are incorporated into our environmentally friendly products, and are recognized in the European market, which has extremely strict environmental regulations.

R32 refrigerant with reduced global warming potential

- **Zero** Ozone Depletion Potential (ODP^{*1})
- High environmental properties
- High performance
- Economically efficient

^{*1} **ODP (Ozone Depleting Potential)**: a relative value that indicates the impact per unit weight of ozone-depleting substances released into the atmosphere when CFC-11 (trichlorofluoromethane, CCl3F) is fixed at 1.0

^{*2} **GWP (Global Warming Potential)**: a measurement that indicates how much other greenhouse gases are capable of warming the Earth based on carbon dioxide. This is the integrated value of radiant energy given to the Earth (i.e., the estimated impact on global warming) expressed as a ratio to CO₂.

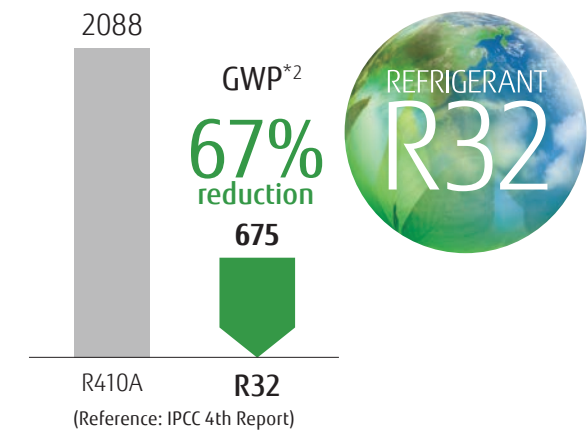

Our pioneering efforts to create a green future

Fujitsu General follows the EU Climate Action Plan 20/20/20 by 2020.

20% Less primary energy use

Fujitsu General's energy-efficient air conditioners are designed to consume less electricity, thus reducing primary energy usage.

20% Less CO₂ emissions

Fujitsu General products closely follow the F-Gas regulation 517/2014/EU.

20% Coming from renewable energy

Fujitsu General is promoting air sourced heat pumps as renewable energy source heating systems

New energy labelling requirement 626/2011/EU
Our air conditioners have reached the "Class A+++" ranking, the highest energy efficiency level that is now shown on energy labels in Europe.

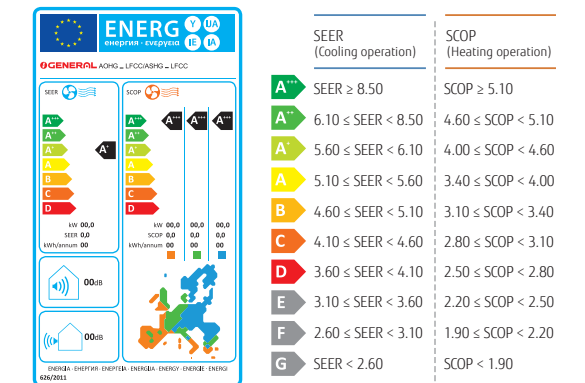

Less is more

Space, Noise, Refrigerant

Less Space

Improved installation flexibility

Our class-leading compact outdoor units range from 8 to 18 HP, and their flexibility in installation does not detract from the appearance of the building.

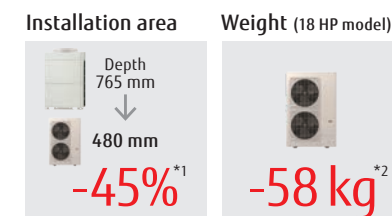

Less Refrigerant

Refrigerant saving design

The compact indoor unit, piping design, and optimization of heat exchanger volume significantly reduce the system refrigerant volume.

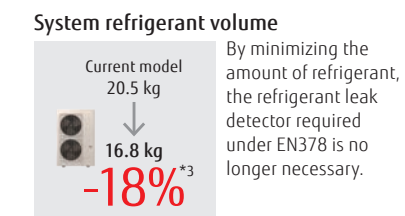

VRF outdoor units J-IVL



Less Noise

Class-leading low operating sound

The outdoor units in this series are designed to operate extremely quietly. They are an ideal choice for installation in densely populated areas.

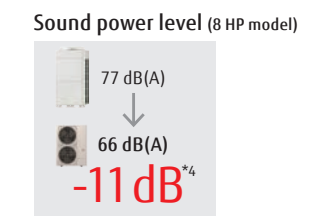

*1: J-IV Series are compared with V Series 14/16/18 HP models. *2: J-IV Series 18 HP model is compared with V-IV Series 18 HP models. *3: E.g.) when 30 indoor units are connected to 1 system (Outdoor unit: 12 HP; Indoor unit: 1.1 kW × 30; Total pipe length: 277.5 m) • J-IV Series is compared with current Series. *4: J-IVL Series 8 HP model is compared with V Series 8 HP



Comfort



Comfortable airflow design

Pursuing the potential of air conditioners and true comfort, Fujitsu General has developed and commercialized numerous world-first technologies, and these concepts are reflected in the design of our products.

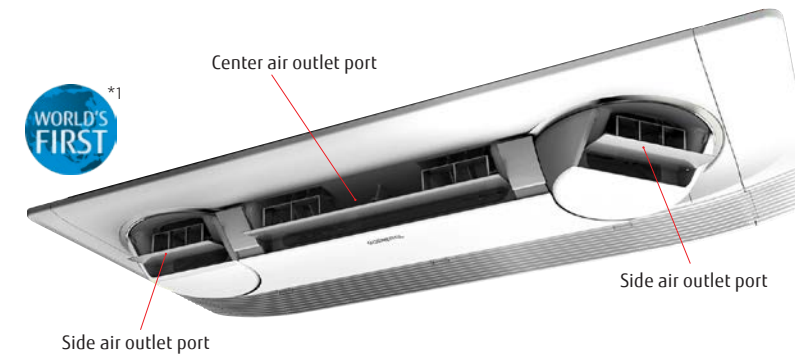

WORLD'S FIRST^{*1}

Center air outlet port

Side air outlet port

Side air outlet port

Cassette type 3D flow Series

3 individually controlled air outlet ports

The Comfortable airflow setting enables the right and left air outlet ports as well as the wide center port to work together to provide a comfortable room environment.

Cassette type One-way flow Series

Wide airflow range created by triangle design and large flap

A large flap with a wide range of movements, equipped with louvers arranged triangularly, sends air into every corner of the room.



Cassette type Circular flow Series

Unique circular flow design

This Series realizes a Circular Flow to blow a large airflow in a 360° direction by using a high-performance DC fan motor, turbo fan, and a unique seamless airflow louver design.



^{*1, *2, *3, *4, *5}

Comfort pursued through advanced technologies



Lambda-shaped heat exchanger^{*3}



Power diffuser^{*4}



Filter auto clean^{*5}



Dual-fans^{*2}



3 Air outlet ports^{*1}

The dual-fans equipped with "nocria X" model in Japan optimally control airflow. The unique form brings a comfortable airflow to every corner of the room. The power diffuser opens the lower flap of the main unit and blows warm air downward to heat the room from the floor, increasing heating efficiency. The Lambda-shaped heat exchanger improves the operating efficiency, contributing to the compactness of the indoor

units. In addition, the automatic filter cleaning function that we have developed ensures ease of maintenance and operating efficiency. The "nocria X" airflow control system is also used in the cassette type, creating a comfortable space with three types of airflow. Fujitsu General's unique technology enables the system to create a comfortable space.

^{*1}: Announced 2018. In room air conditioner for the home (Our company's investigation) ^{*2}: Announced 2012. In room air conditioner for the home (Our company's investigation) ^{*3}: Announced 1994. In room air conditioner for the home (Our company's investigation) ^{*4}: Announced 1991. In room air conditioner for the home (Our company's investigation) ^{*5}: Announced 2002. In the category of room air conditioners for the home (Our company's investigation).



Control

Operation from anywhere

Using the Internet of Things (IoT), Fujitsu General is actively providing services that allow users to control their air conditioners from their smartphones. We are also expanding our open co-creation activities with external partners to deepen the development of new functions and services using IoT and artificial intelligence (AI) to develop safe and convenient air conditioners.



NEW
User-friendly screen display enables easy operation.
With the WLAN adapter and the AIRSTAGE Mobile app, you can control the heating and cooling of your home anytime, anywhere.

Should you forget to turn off the system before you leave home, you don't have to worry.

"AIRSTAGE Mobile" is a software application that allows users to control Fujitsu General air conditioners from anywhere with a mobile device while out or on the move.

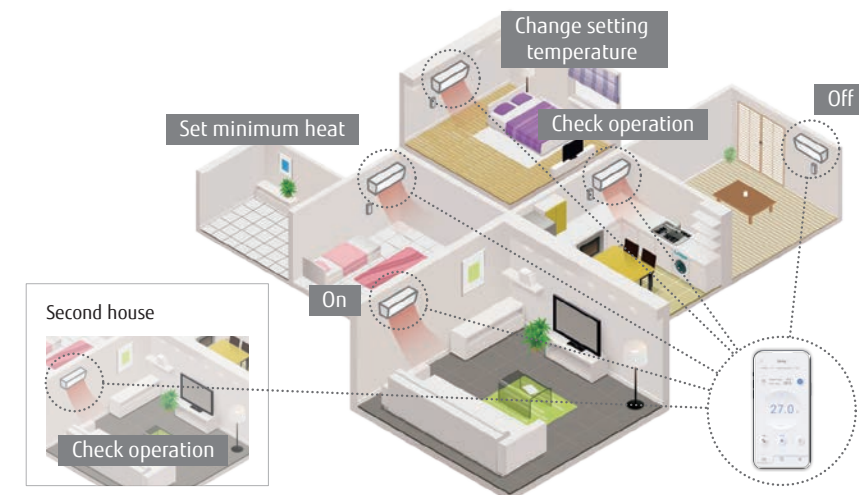

WLAN adapter

The dedicated WLAN adapter enables the air conditioner to be operated by smartphone or tablet PC from outside the home.



NEW AIRSTAGE Mobile

Download Free



Compact wired remote controller

- Large screen and simple display**
- Large screen, yet compact in size
 - Large, easy-to-read letters are used.
 - The controls are simple and easy to understand.



Central remote controller for VRF system

The central remote controller uses a touch panel screen to display multiple menus on the top screen. Just touch the menu you want to operate, and the necessary window will pop up, and allow intuitive operation.

Remote monitoring and operation

The central remote controller enables monitoring and control of a tenant's air conditioner anytime, anywhere.

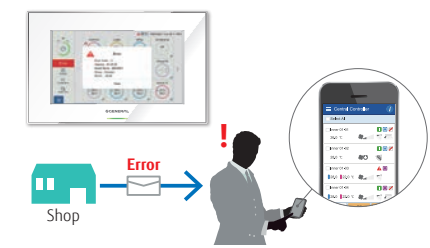



Design



Create a beautiful space

Fujitsu General offers a wide range of products for the European market, including models with unique textural designs, award-winning models that integrate with room interiors, and Cassette type models with different designs that match office spaces. We also have a lineup of models with elegant designs, such as the Ceiling type models with its beautiful curved surface.

KE Series

Wall-mounted type

KE Designer Series

We have designed this series exclusively for the European market. The exterior design harmonizes beautifully with any decor and adds comfortable elegance to the room. The light, elegant and three-dimensional expression achieved by the curved surface looks beautiful from any angle.



CMF: Color Material Finish

The texture of the front panel expresses the craftsmanship of Europe, and changes its expression with the changing light of the day.

Design award-winning products

Wall-mounted type, design Series



Light Elegant Design

New Ceiling type design

The light, elegant and three-dimensional expression achieved by the curved surface gives a sense of comfort and well-being.



Different Cassette type Designs



Compatible with grid ceiling systems
Compact cassette Series
for grid ceiling



Beautiful design from any angle
Cassette type Circular flow Series
White panel



For ambience with dimmed lighting
Cassette type Circular flow Series
Black panel



History

Yaou Shoten Ltd. established in 1936

Overseas air conditioning business since 1971

Starts air conditioning business in Japan in 1960

1971 Air conditioner exports to the Middle East.

1977 "Super Power, Super Quiet" Series released

1982 Window type 3 Super Series released

AL/AX Series



1985 Large wall-mounted type and multi-split air conditioner released.

WORLD'S FIRST *1,*2 **1991** World's first air conditioner equipped with lambda-shaped heat exchanger

1994 World's first air conditioner with power diffuser

2001 AIRSTAGE Series released VRF air conditioners for large buildings



WORLD'S FIRST *3 **2002** Air conditioner with the world's first automatic self-cleaning filter system

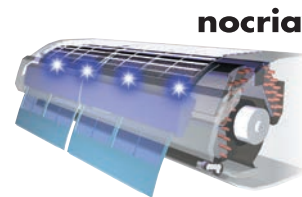

2004 Standalone Compact VRF AIRSTAGE J Series released



2006 VRF Heat Pump type Maximum 42 HP AIRSTAGE V Series released



2009 VRF Heat Pump Modular type Maximum 48 HP AIRSTAGE V-II Series released



2009 Air to water system released

For Light commercial use

2011 High energy-saving type AIRSTAGE J-II Series released

2014 Compact & lightweight outdoor unit AIRSTAGE J-IIS equipped with a single fan for improved ease of installation

2016 Compact VRF AIRSTAGE J-III Series with advanced energy efficiency and easy installation released

2017-19 Compact VRF AIRSTAGE J-IIIIL Series for light commercial use released

2020 Compact & lightweight outdoor unit AIRSTAGE J-IVL, J-IV, J-IVS Series released



2019 New cassette style released 3D Flow Cassette

For Commercial use

2012 Heat Recovery Modular type AIRSTAGE VR-II Series Maximum 48 HP released



2020 AIRSTAGE Air handling unit released

2014-15 Heat Pump Modular type AIRSTAGE V-III Series Maximum 54 HP for large buildings released

2020 Heat Recovery type AIRSTAGE VR-IV Series Maximum 48 HP released

For Residential use

2011 Hi-spec Design model LT Series & LU Series released

2017 Flagship Wall-mounted type "nocria X" released

2017-19 Added to this lineup recently are the environment-friendly R32 refrigerant models. (Split & Multi-split type)



For Commercial use

VRF V-IV

2022 Release of new products with energy-saving operation.



For Residential use

R32 Split & Multi-split New products released with new wireless LAN control system.



KM Series New standard series for large rooms released.

Smart control New wireless LAN control system released.

AIRSTAGE Mobile



1950 ~

1970 ~

2000 ~

2010 ~

2023 What's New

Manufacturing Company Establishment

1955 Head Office established in Kawasaki

1964 Electronic components factory in Ichinoseki



1977 Air conditioner manufacturing company in Hamamatsu (now Hamamatsu business office)

1991 Air conditioner manufacturing company in Thailand

1994 Air conditioner manufacturing company in Shanghai, China

1998 Air conditioner motor manufacturing company in Thailand

2006 VRF air conditioner manufacturing, sale, and service company in China

2007 Air Conditioner Technology Building becomes operational on the premises of the Kawasaki Headquarters. Air conditioner R&D Center in Kawasaki

2009 Compressor Factory begins operation in Thailand

2012 Joint venture in Thailand to manufacture compressors

2016 Commercial use air conditioner R&D Center in Thailand



2019 New building constructed at Kawasaki Head Office to strengthen development capabilities:

Base for creating new value by combining internal and external knowledge



2020 Building IoT-based manufacturing

Implementing a real-time IoT system to instantly visualize and analyze various information



Fujitsu General (Thailand) Co., Ltd. (Thailand) Factory-2

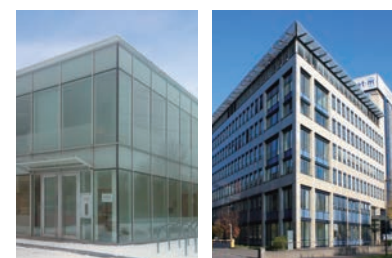

Fujitsu General (UK) Co., Ltd. (UK)



Fujitsu General (EURO) GmbH

Sales & service maintenance company established

1976 North America sales company

1977 Europe sales company (UK)

1978 Australia sales company and Europe sales company (Germany)

1980 Brazil sales company

1997 Asia sales company (Singapore)

1998 Middle East sales company (UAE) and New Zealand sales company

2000 Air conditioner manufacturing and sale technical partnership in India

2002 Taiwan sales company

2006 China sales company

2016 THE AIRSTAGE on Broadway in New York



*1: Announced 1991. In room air conditioner for the home (Our company's investigation) *2: Announced 1994. In the category of room air conditioners for the home (Our company's investigation). *3: Announced 2002. In the category of room air conditioners for the home (Our company's investigation).

*4: Announced 2018. In room air conditioner for the home (Our company's investigation) *5: Announced 2012. In room air conditioner for the home (Our company's investigation)



Worldwide locations

Under a system of five bases in Europe, the Middle East, Asia and Oceania, North and South America, and Japan, the company promotes Globalization from a worldwide perspective while emphasizing the actual conditions in each region.



JAPAN Head Office



Technology research building (Japan)

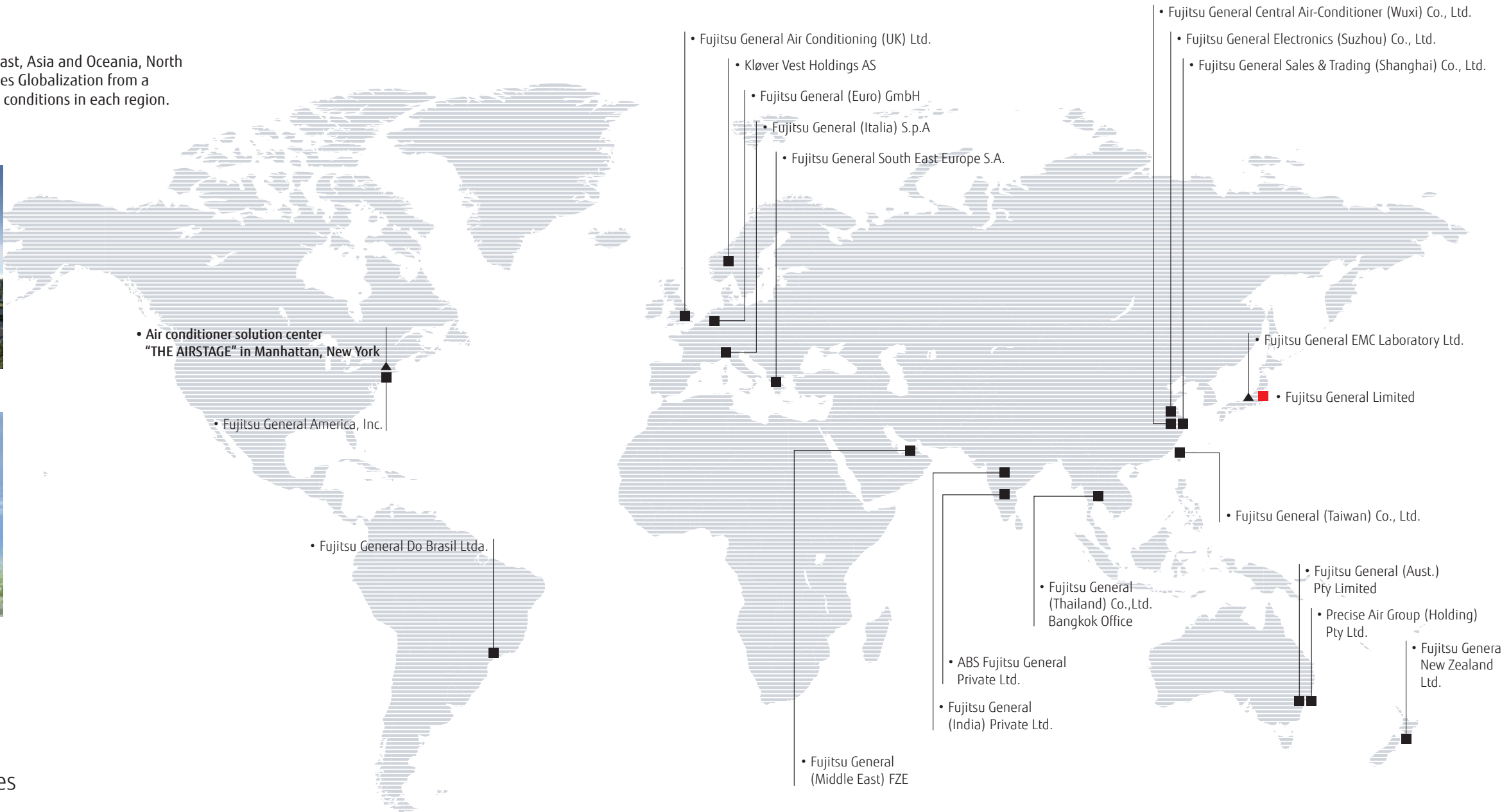

18 Overseas Sales Companies

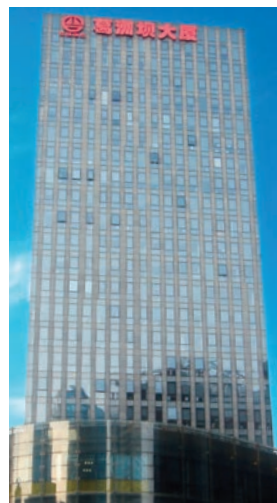

Fujitsu General Sales & Trading (Shanghai) Co., Ltd.



Fujitsu General (EURO) GmbH Co., Ltd. (Taiwan)



Fujitsu General (Thailand) Co.,Ltd. Bangkok Office (Thailand)



Fujitsu General Electronics (Suzhou) Co., Ltd.



Fujitsu General South East Europe S.A. (Greece)



Fujitsu General (India) Private Ltd. (India)



Fujitsu General Air Conditioning (UK) Ltd. (U.K.)



Fujitsu General (Italia) S.p.A (Italy)



Fujitsu General (India) Private Ltd. (India)



Fujitsu General (Aust.) Pty Ltd. (Australia)



Precise Air Group (Holding) Pty Ltd. (Australia)



Fujitsu General New Zealand Ltd. (New Zealand)



Fujitsu General (Middle East) FZE (U.A.E.)



ABS Fujitsu General Private Ltd. (India)

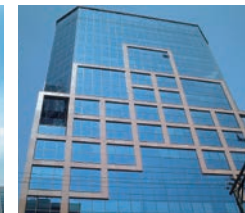

Fujitsu General Do Brasil Ltda. (Brasil)



Fujitsu General America, Inc. (U.S.A.)



Kløver Vest Holdings AS (Norway)



FUJITSU GENERAL SOLUTION CENTER "THE AIRSTAGE" (U.S.A.)



Global business activities

We have been recognized for our activities in advertising, human resource development and customer service, as well as for our community-based social contribution activities in each region, winning numerous awards and achieving a high level of customer satisfaction.

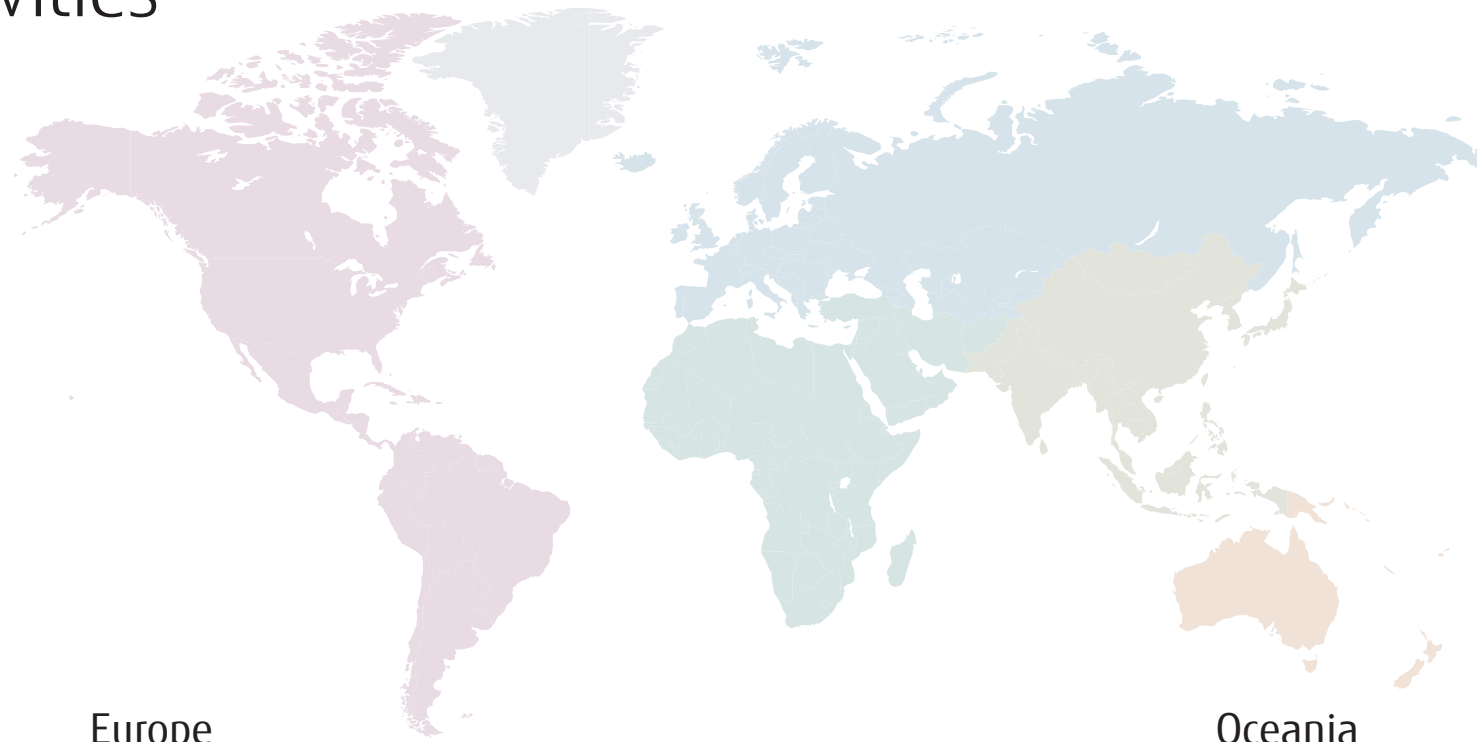

North and South Americas



AHR Expo



HVAC trade shows in Brazil



Distributor conference in USA



Call center

Middle East



Exhibition



Training in Kuwait



Technical seminar

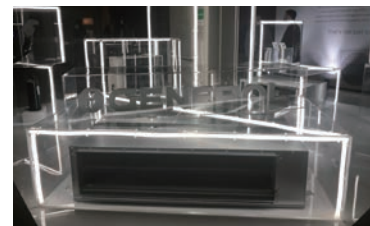

New product seminar in UAE

Europe



HVAC trade show in Germany



Training in Germany



HVAC trade show in Germany



Training seminar in Italy



Event in the United Kingdom

Oceania



HVAC trade show in Australia



Launch event in New Zealand



Launch event in New Zealand

Asia



Thanksgiving party in Taiwan



Training in India



Opening ceremony in India



New product presentation seminar in Singapore



Service training in Vietnam

International authoritative design awards



The NEWS Dealer Design Awards



Gold Award (Category: HVAC & PLUMBING) in Reader's Choice Awards



TOP OF MIND 2016 First prize in "MARCA DE EQUIPAMENTO DE AR-CONDICIONADO" category of "CLIMATIZACAO" division



Superbrands is the world's largest independent arbiter of branding.



The iF Product Design Award is given annually by iF International Forum Design GmbH for industrial products from around the world.



The Plus X Award is the world's largest innovation award for technology, sports and lifestyle.



reddot winner 2020

A product design competition that has been held since 1955. Products that win the award are given the "Red Dot" seal, a sign of international recognition of quality.



ProductReview.com.au's annual awards are selected from products and services that have been well-rated by the ProductReview community.



Voted by Australians as the 'Most Trusted Brand' - Air Conditioning Category 5 Years Running



China State Construction Engineering Luban Prize



The Good Design Award is an award sponsored by the Japan Institute of Design Promotion, and is given once a year to items of outstanding design.



Project references

Introduced in over 50 countries worldwide

Highly popular for their excellent quality, energy efficiency, and ease of installation, Fujitsu General's products are installed in a wide range of buildings around the world, including high-rise office buildings, stores, hotels, public facilities, schools, hospitals, and residences.

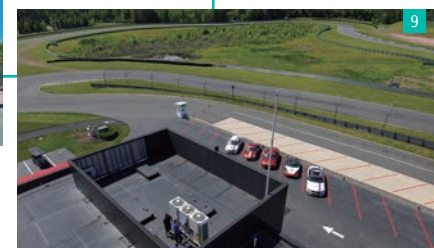
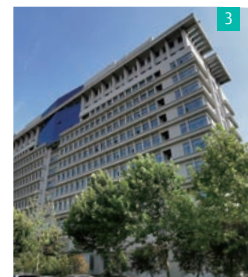

For Light commercial use

- 1 Shop in Europe
- 2 Factory in Europe
- 3 School in Asia
- 4 Hospital in Asia
- 5 Office in Asia
- 6 Shop in Oceania
- 7 Office in Oceania
- 8 School in the Middle East
- 9 Public facility in the United States

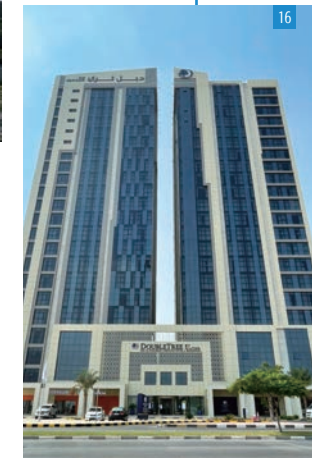
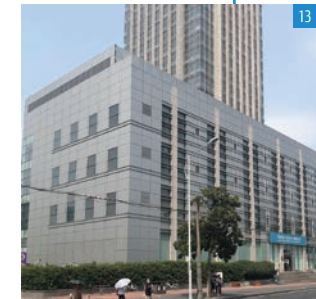

For Commercial use

- 10 Public Square in Asia
- 11 Office in Asia
- 12 Hotel in Asia
- 13 Public facility in Asia
- 14 Apartment in Oceania
- 15 Apartment in Oceania
- 16 Hotel in the Middle East
- 17 Hotel in the Middle East



For Residential use

- 18 Villa in the Africa
- 19 Residence in Oceania
- 20 Residence in the United States
- 21 Villa in the Middle East



Global development & Production bases

We have established R&D bases in five countries from Japan, Europe, Asia, China, and North America to pursue environmental properties and comfort according to the needs of each region.

- Head office
- R&D center
- Manufacturing companies



R&D center & Technology Research Building



R&D center in Fujitsu General (EURO) GmbH (Germany)



North America R&D Center (USA)



Fujitsu General Air Conditioning R&D (Thailand) Co., Ltd. (Thailand)



R&D center in Fujitsu General (Shanghai)



JAPAN Head office, R&D center and 60 m height difference testing tower (Japan)

Technology research building in Japan Head office



Constructing IoT-based manufacturing
We are implementing a real-time IoT-enabled system to immediately visualize and analyze various information such as facility operating status, assembly line production progress, and parts inventory and transportation status. This will further enhance the accuracy of production and shipping forecasts in the Head Office and factory management departments. The system will also help improve activities by employees at production sites, with the aim of improving the efficiency of the production process, the efficiency of parts distribution operations, and the utilization rates of the facilities.

Overseas manufacturing companies



Fujitsu General (Shanghai) Co., Ltd. (China)



F.G.L.S. Electric Co., Ltd. (China)



Fujitsu General Central Air-conditioner (Wuxi) Co., Ltd. (China)



Fujitsu General Electronics Ltd. (Japan)



Fujitsu General (Thailand) Co., Ltd. (Thailand) Factory-2



Fujitsu General (Thailand) Co., Ltd. (Thailand)

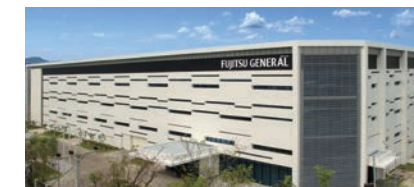

Fujitsu General Air Conditioning R&D (Thailand) Co., Ltd. (Thailand)



FGA (Thailand) Co., Ltd. (Thailand)



TCFG Compressor (Thailand) Co., Ltd. (Thailand)



High-quality development & Production facilities

Advanced Research Facilities and Equipment

Performance tests



Airflow measurement room
Measure the airflow of air conditioners, from compact room air conditioner models to variable refrigerant flow (VRF) systems.



Calorimeter
Measure the temperature, humidity, and airflow at the inlet and outlet of the air conditioner to evaluate its cooling and heating capacity.



Silent room
Measure the operating sounds of air conditioners on walls and ceilings with reduced sound reflection.

Fujitsu General is one of Japan's leading manufacturers with R&D centers in Japan. The research and development conducted in these facilities contributes to providing our customers with the highest quality and performance.

Reliability tests



Constant temperature room
Verify product performance in cooling and heating operations under various temperature and humidity conditions.



Practical test room
Check whether the performance of the air conditioner can be sustained under the conditions of the actual housing environment.



Shower test room
Check if the electrical box of the outdoor unit is protected from strong wind and rain, such as during a typhoon.

Transportation and Handling Tests



Compressibility test



Vibration test



Technology research building in Japan Head office

Testing laboratory

Fujitsu General EMC Laboratory Limited

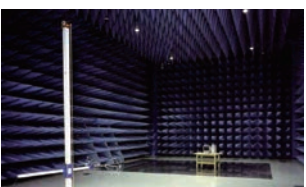
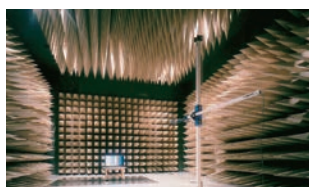

60-m Height Difference testing tower

Tests oil circulation in a compressor for reliability.



Certification of ISO 9001 and ISO 14001

■ ISO 9001
■ ISO 14001
() Number of companies

The Group's 5 overseas production subsidiaries are individually certified with ISO 9001 and ISO 14001. The Group's 11 overseas sales subsidiaries have been certified with ISO 14001 since 2012.

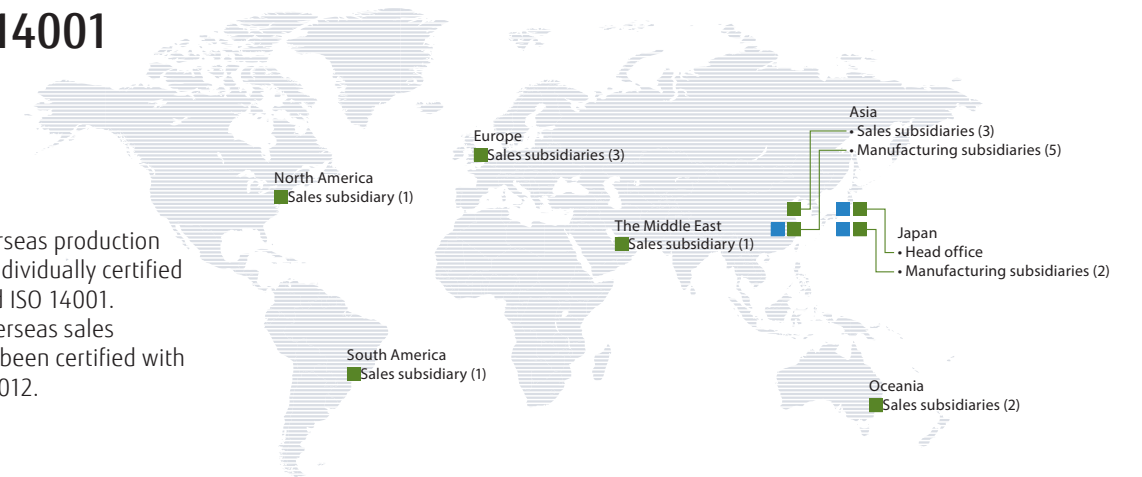

Product Quality Assurance

All Fujitsu General plants are ISO 9001 certified and operate under a unified quality control system. We deliver to customers all over the world high-quality products that have passed stringent quality inspections.

Receiving inspection

We require all our parts suppliers to submit test reports to ensure that all parts we receive from them meet our quality standards. Our in-house test department inspects incoming parts to ensure their compliance with RoHS as required by the EU. We also conduct 100% inspection of main parts to prevent defective parts from making it to assembly lines.

Quality inspection of products

We carry out stringent quality inspections in all production processes performed in our plants. To keep the quality of our products high, inspectors check their quality from start to finish on production lines.

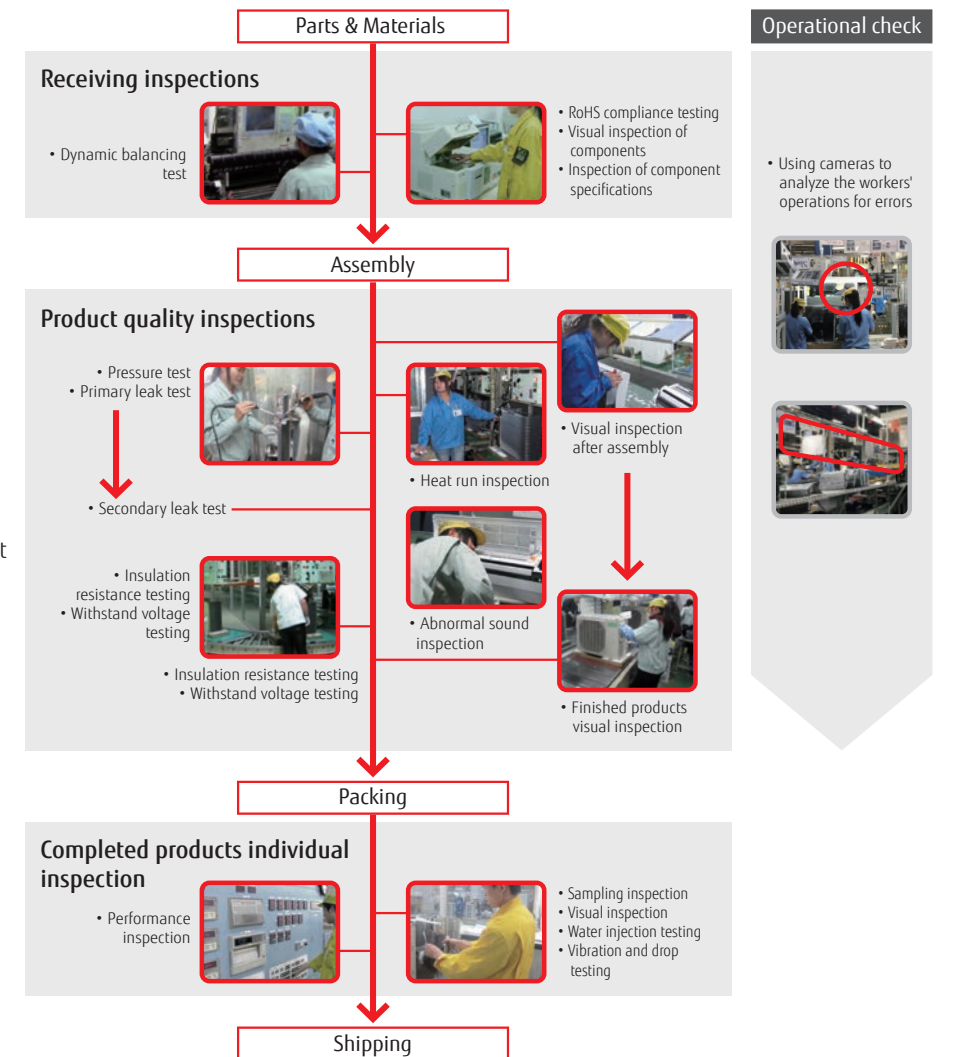

2023 New Products

KE Designer Series
Cool Beauty Design



Wall-mounted type Built-in W-LAN adapter models

Designer Series, Standard Series

S-014-019

- 7-14 classes, 16 models
- High energy saving
- New built in WLAN adapter
- Comfortable airflow & Quiet operation
- R32 refrigerant & low refrigerant volume
- Easy access to the flare pipe connection



KG Designer Series
High Spec & Design



KE Designer Series
Cool Beauty Design



KM Standard Series
High Efficiency & Large Room

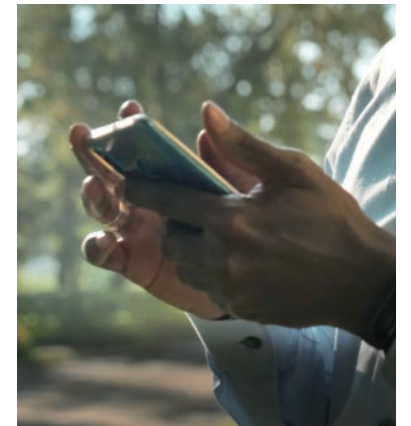

Smart Device control
You need to install the "AIRSTAGE Mobile" app on your smart device in order to control the air conditioner.

Wall-mounted type

Standard Series (High-Efficiency & Large Rooms)

S-022-023

- 30 and 36 classes
- Small, lightweight outdoor unit
- Occupancy Sensor
- R32 refrigerant & low refrigerant volume
- New WLAN adapter (Option)
- New Refrigerant Cycle Monitor (Option)

KM Standard Series
High Efficiency & Large Room



 CONTROL SYSTEM

AIRSTAGE Mobile

C-018

- Operation from anywhere
- Multiple air conditioning management
- Group management
- User friendly for everyone
- New design
- Increases the number of accounts
- Pairing with smart speaker



MODBUS® interface

C-035

MODBUS® interface enables air conditioners to be fully integrated into a MODBUS® network.

- Small, compact, and easy to install.
- No separate external power supply required.
- MODBUS® interface enables central monitoring and control of air conditioners from BMS.



BACnet® interface

C-037

- BACnet® interface connects BMS and a Fujitsu General split/multi-split/VRF system.
- Compatible with BACnet® (ANSI/ASHRAE-135-2012) application-specific controller (B-ASC)
- Compatible with BACnet®/IP over Ethernet.



From Business to private spaces
SOLUTIONS

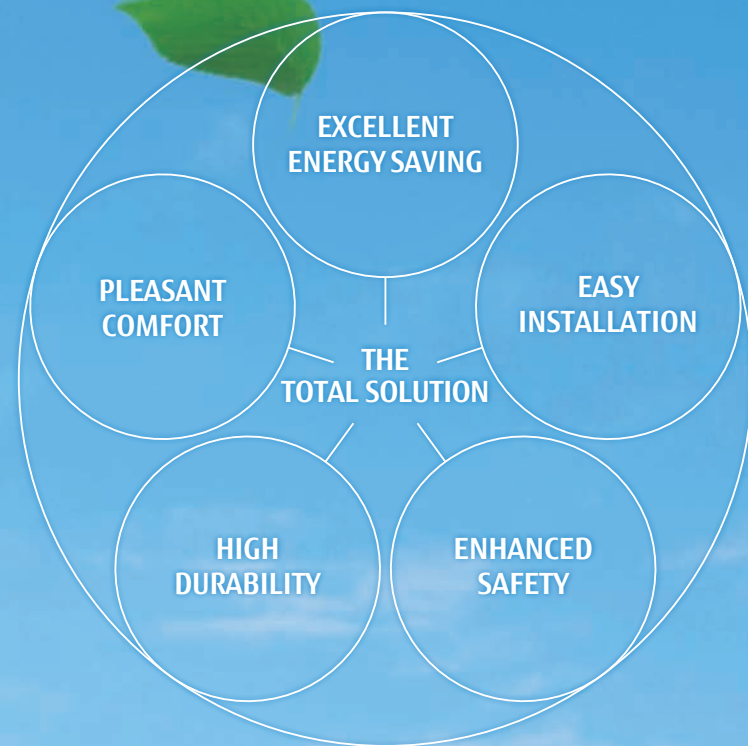

Key solution points

Fujitsu General's total solutions are tailored to each property's unique needs.

Fujitsu General provides the best control solutions for buildings.

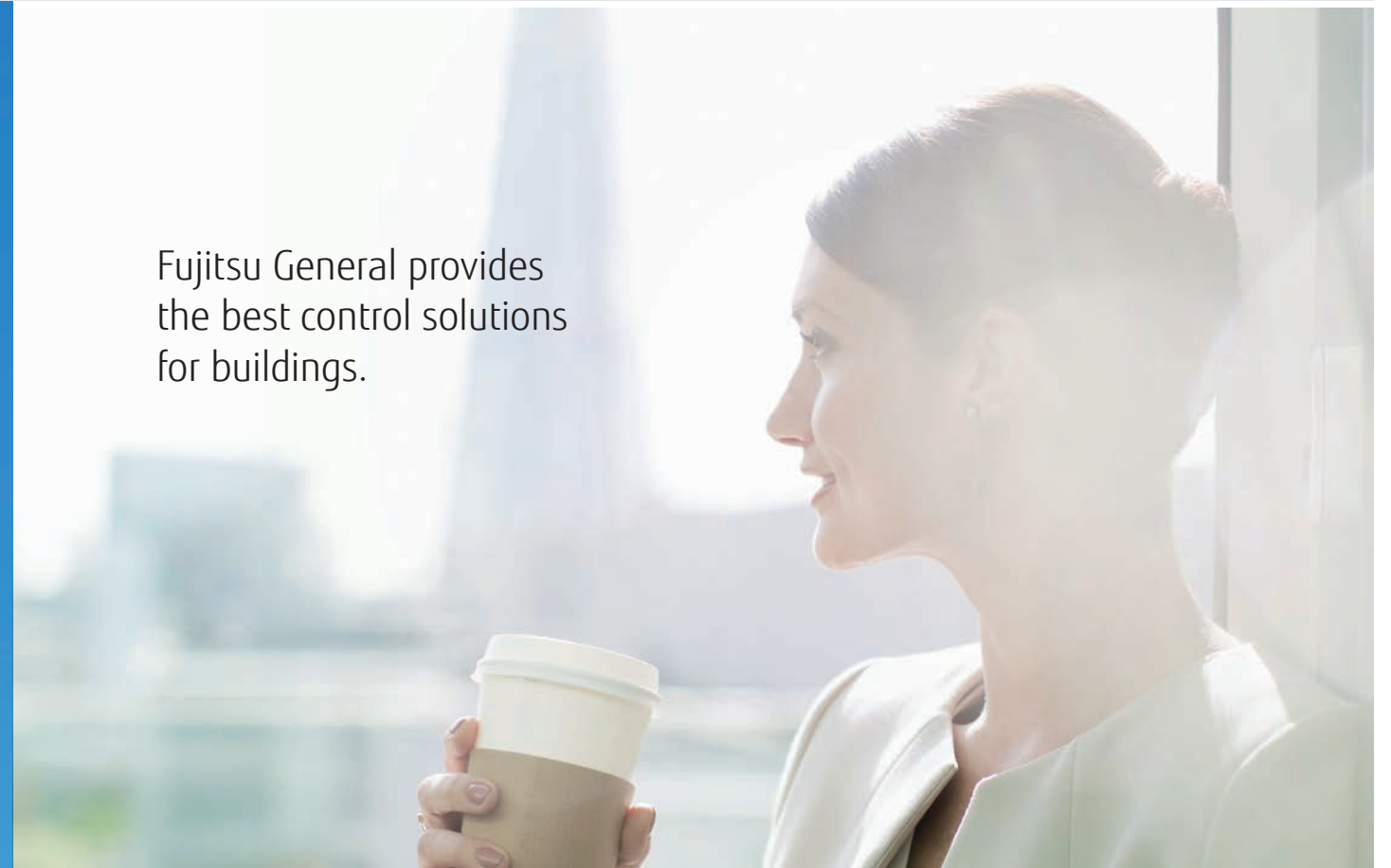

Target buildings

- A casual conversation with a colleague at work
- A presentation in a large meeting room
- A restaurant you stop by Your living room

We have a comprehensive lineup of air conditioners ideal for all these situations—from business to private spaces. Fujitsu General's air conditioners are used in all aspects of everyday life.



For Light commercial use

Comfortable and economical air conditioning systems, ideal for small and midsize commercial buildings

- 038 Shops and Restaurants
- 040 Small offices
- 042 Hotels
- 044 Schools



For Commercial use

Single and modular VRF systems for high efficiency, comfort, design flexibility, ease of installation, and high reliability

- 046 Large Buildings



For Residences

Smart air conditioning systems with extensive control options for comfort and convenience of use

- 048 Residences

Restaurant, shops

For Light commercial use

Fujitsu General provides perfect total air conditioning systems that offer seamless support by tenant, by purpose, and by customer visit frequency in shops and restaurants with multiple lighting and a high density of customers.



Single split

For Restaurants

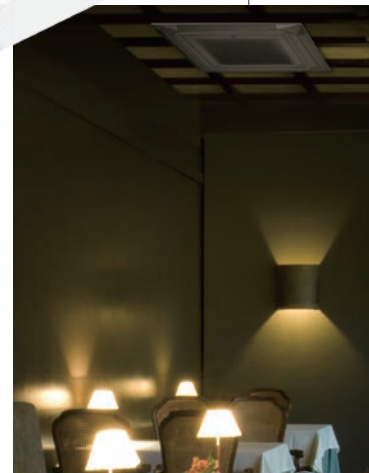
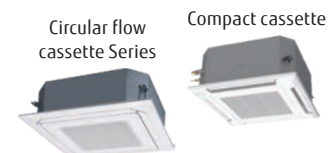
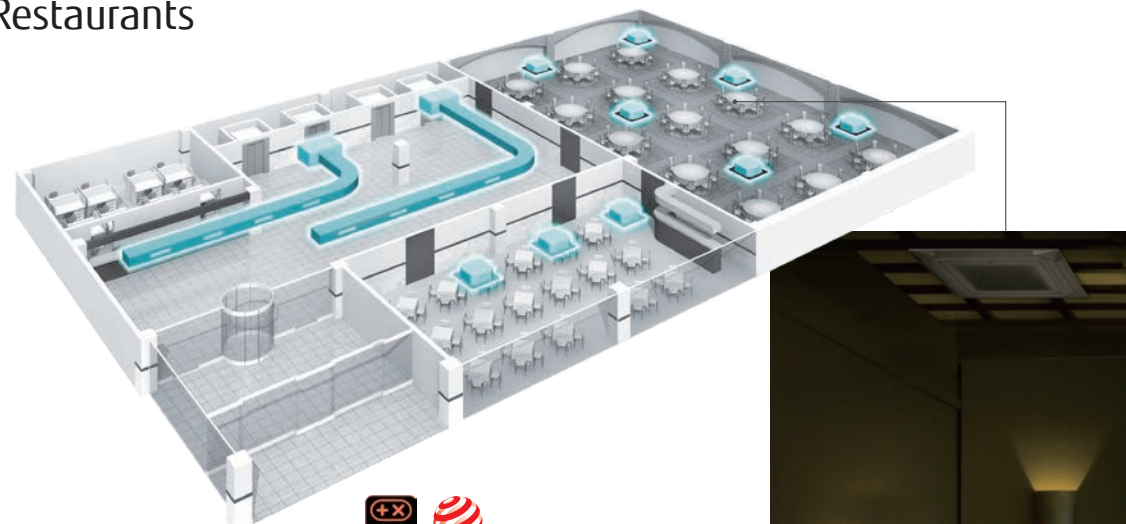

R32 large model lineup expanded

Expanded lineup of ceiling, cassette, and duct types suitable for large spaces using environmentally friendly R32 refrigerant

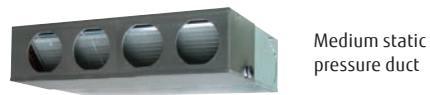

High static pressure duct

Medium static pressure duct

NEW

Two panel colors

Both black and white panels are available for Cassette type. Black panels are suitable for dark places such as atmospheric restaurants. White panels, by contrast, are more appropriate for use in brightly lit spaces such as offices. (Available for Single split and VRF indoor units)

Simultaneous multi-split

For Shops

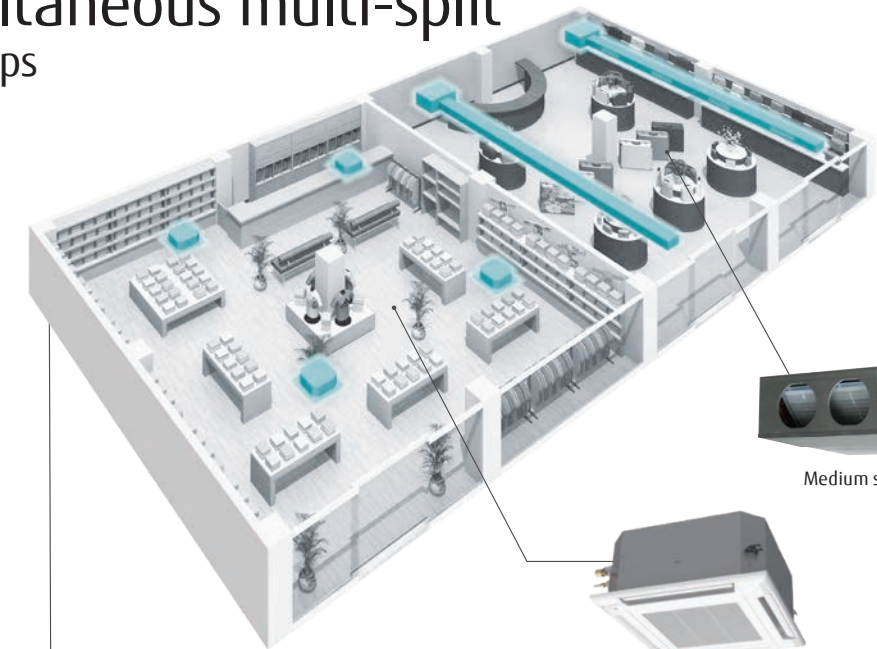

Medium static pressure duct



Compact cassette



Slim duct



Twin 36 class (Single phase)

Twin/Triple 45/54 class (Single phase)

Various indoor unit lineup

You can choose from 3 types of indoor units to suit the atmosphere and layout of your shop.

Small, lightweight outdoor unit

Models equipped with the new R32 refrigerant. Compared to current models, the outdoor unit is more compact and easier to install. (45/54 models)
Compact cassette Series for grid ceiling were added to the lineup of indoor units to improve ease of installation.

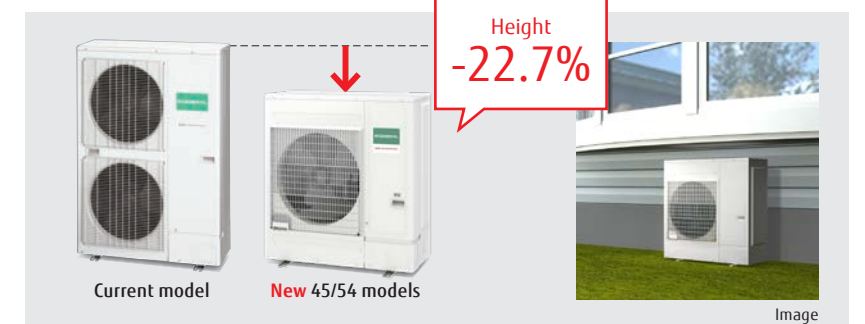

Current model

New 45/54 models

Height -22.7%

Image

Small offices

For Light commercial use

Fujitsu General offers a perfect total air conditioning system for small office buildings with multiple small rooms, taking into consideration energy savings, low noise, comfortable air volume, usage and purpose, and centralized control.

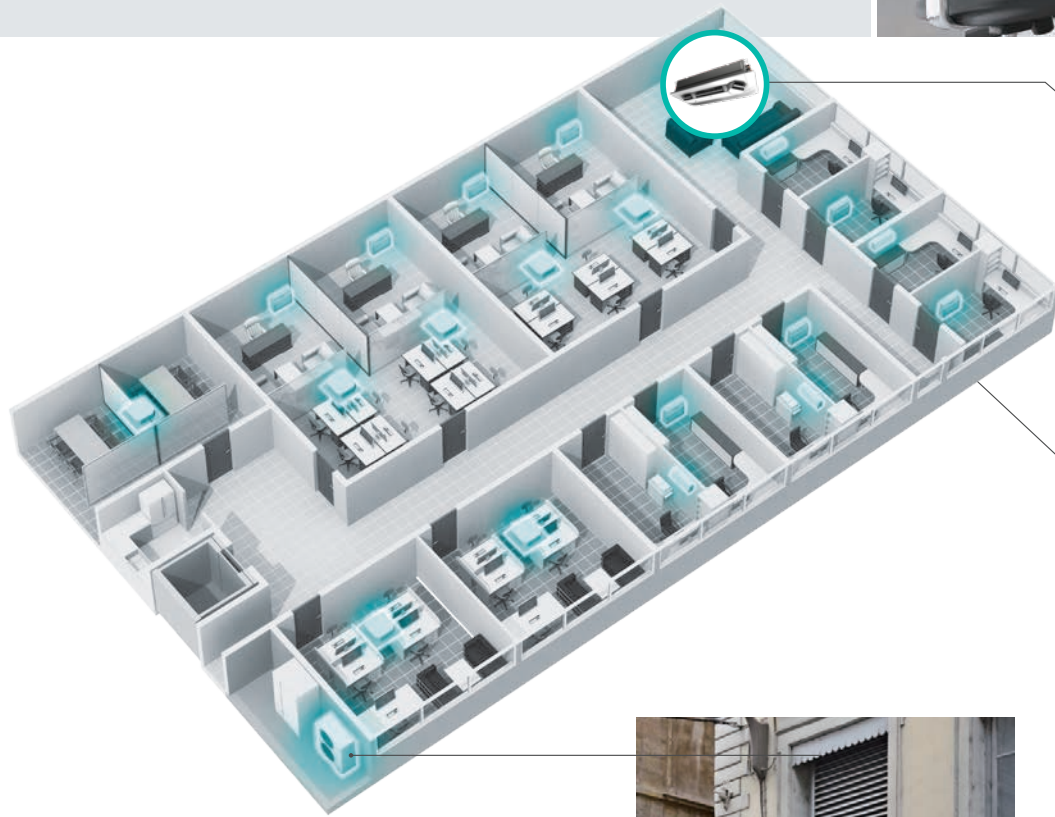

VRF J Series compact outdoor units with up to 18 HP

Suitable for the buildings with multiple small rooms. Up to 42 indoor units* can be connected.

*Only J-IVL Series 18 HP model

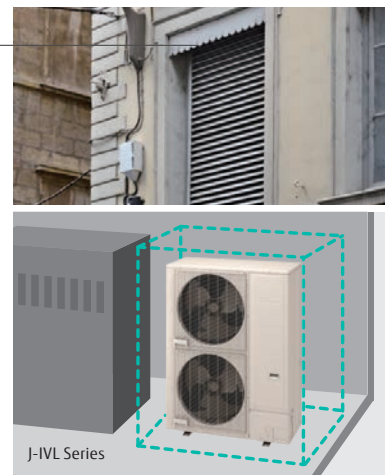

Compact outdoor unit with low noise design

Takes up little space even when installed in a machine room or on the roof. Sufficient static pressure can be maintained even with louvers. Low-noise mode suffices even for nighttime operations at low noise levels.

Breakthrough 3D flow cassette with innovative pursuit of comfort

The left and right air outlet ports with a maximum rotation angle of 100° and the wide central air outlet port create a comfortable space with less uneven temperature.



Wide lineup of indoor units of low-capacity class

Various low-capacity 1.1 kW indoor units are available for small rooms and spaces.

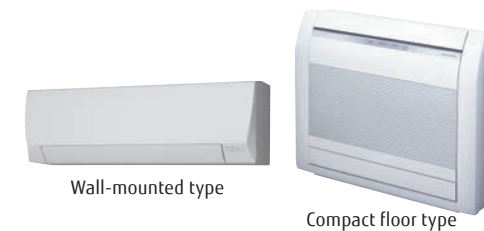

Central remote controller UTY-DCGGZ2



Central remote controller with improved operability

Controls the temperature of each room easily, and manages and sets the operation control for a week. Energy-saving management by setting upper and lower temperature limits and operating prohibitions.

LAN



Computer

Control and monitoring

You can operate the main unit from your desk. Non-administrators can also operate the air conditioners with a computer, smartphone or tablet PC.



Wireless LAN

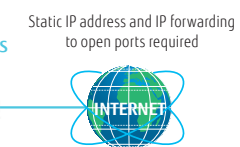

Tablet PC

Smartphone

*Wireless LAN will be supported in the future.

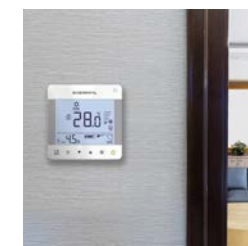

Compact wired remote controller

Compact size with a large screen for easy operation. The stylish design harmonizes with the interior.

Hotels

For Light commercial use

Fujitsu General offers total air conditioning systems perfect for low-rise, small hotels that take into account energy savings, external appearance, safety, and ease of installation.

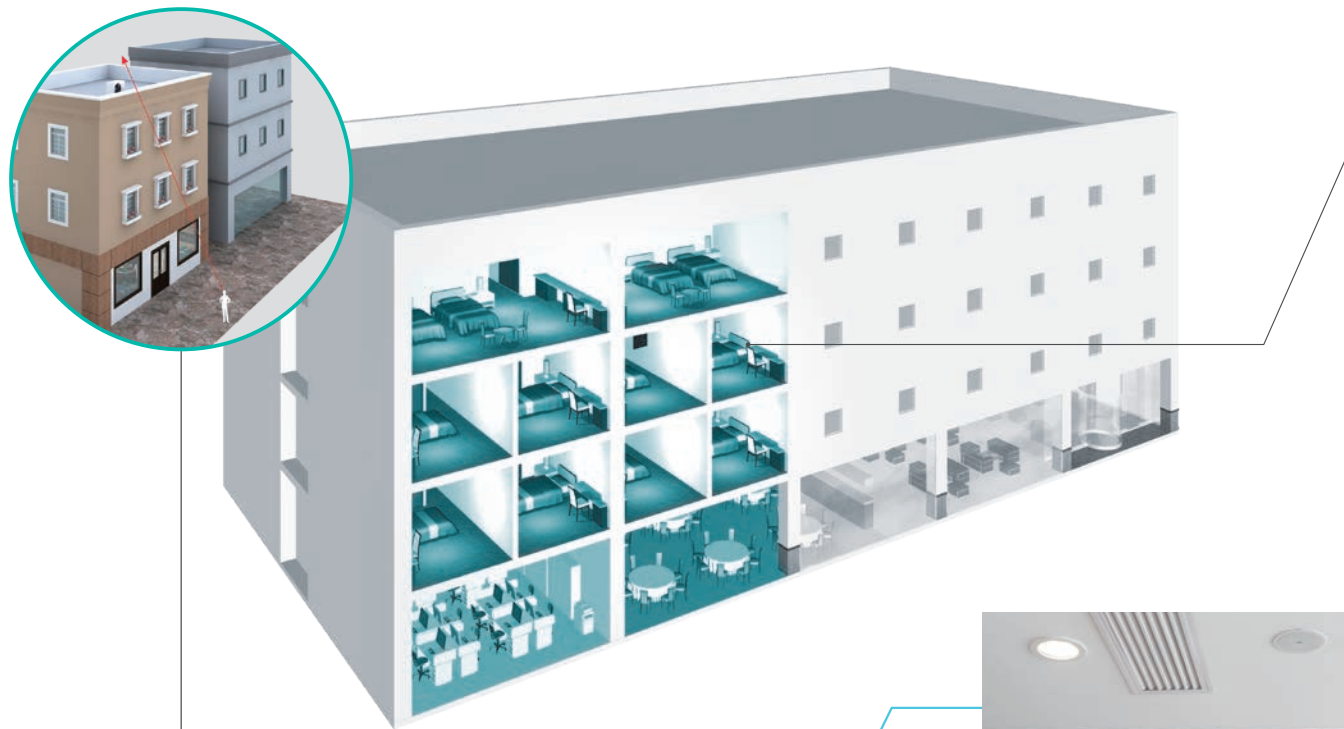

VRF J Series compact outdoor unit with appearance-conscious design

The class-leading compact design will not detract from the appearance of the hotel.

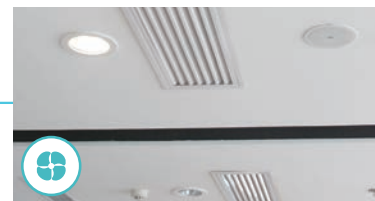

Supports ventilation for the entire hotel

Outdoor air processing is essential in an airtight hotel space. The DX kit links up with air conditioners to ensure sufficient ventilation. The system is expandable.

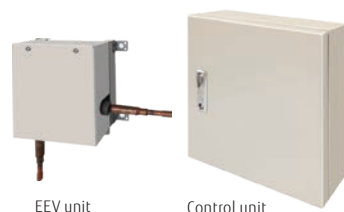

Guest room air conditioning with superior comfort, energy efficiency, and ease of installation

Space saving
Mini duct type with a height of 198 mm and a depth of 450 mm. Easily installed in a narrow ceiling space.



Mini duct



Card key switch available
Linked to a card key to prevent people from forgetting to turn off the air conditioner.

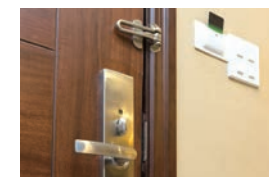

External connection switch

Comfortable airflow by switching the up/down airflow direction
The Auto louver grille kit creates comfortable airflow by adjusting the air direction.

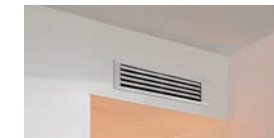

Auto louver grille kit

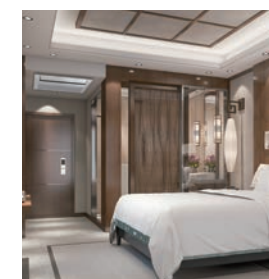

One-way flow cassette Series

Compact chassis with low noise operation
The low operating noise makes the model ideal for use in hotel rooms.



Centralized control of air conditioning for shared spaces

Lobbies, hallways, and other common spaces are centrally controlled for air conditioning. Temperature and operating conditions can be managed without any adjustments by the guests.



System controller

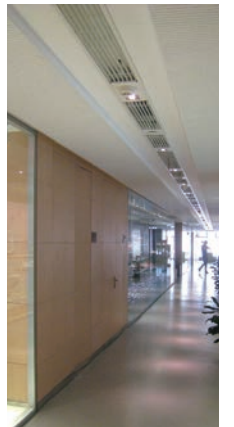

Simple remote controller with sophisticated design

The ease of operation makes it an ideal choice for use in hotels or offices. Simple buttons and a white backlit large LCD screen make it easy to operate in the dark.



Large space air conditioning for the reception area and lobby

Duct type Big duct Series suitable for large spaces with high ceilings



Schools

For Light commercial use

Fujitsu General offers indoor units that allow multiple connections with a compact design that reduces the installation area and increases the flexibility for selecting installation locations, making them perfect for midsize educational institutions. One single outdoor unit is able to cover an entire school building.

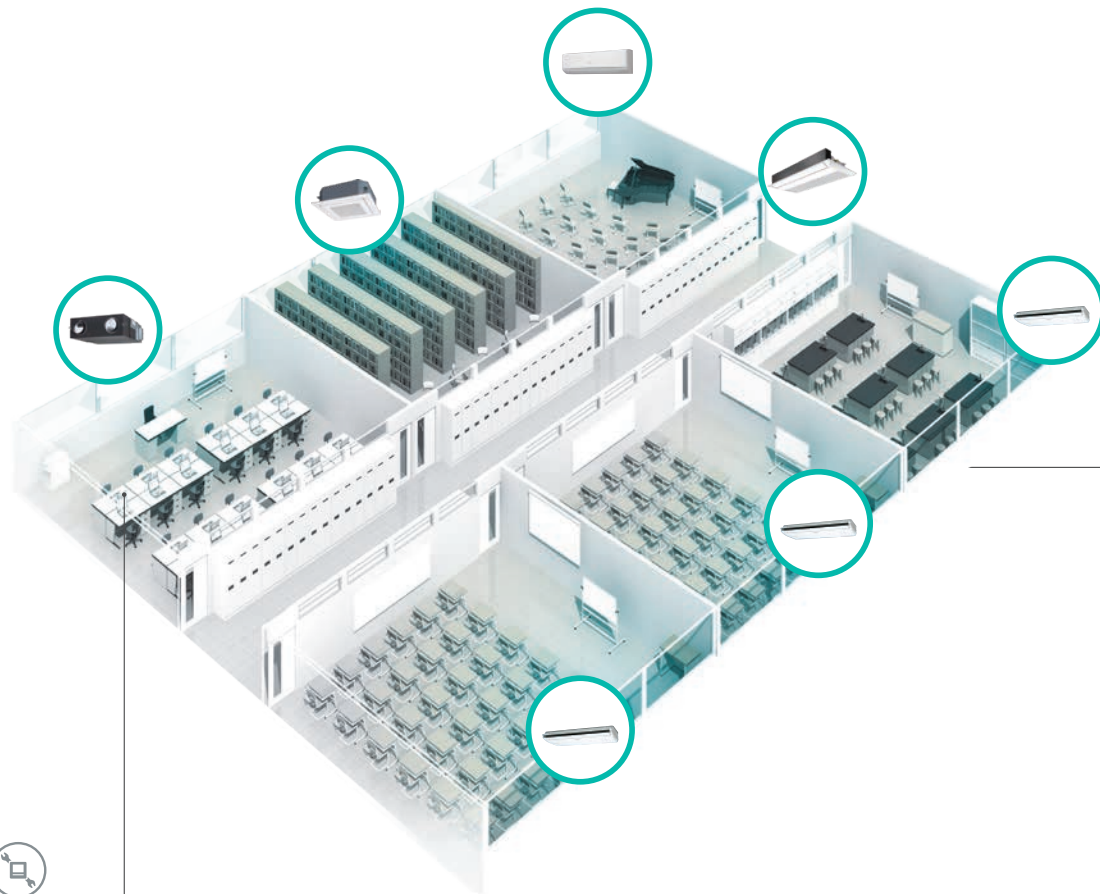

Centralized control of both air conditioning and ventilation equipment

Centralized control is also possible to stop the operation of not only air conditioners but also lighting and ventilation equipment. These features are useful for managing the energy efficiency of the entire building.

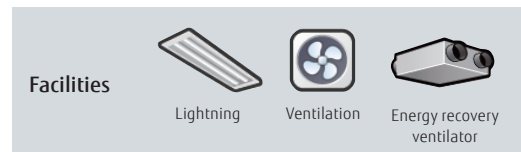

System controller Lite

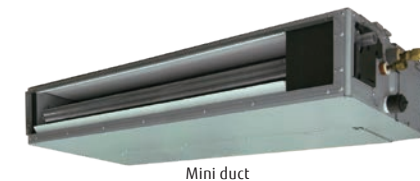

Wide variety of indoor units

Support complex applications for regular classrooms, special classrooms and auditoriums. Ventilators can also be added easily.

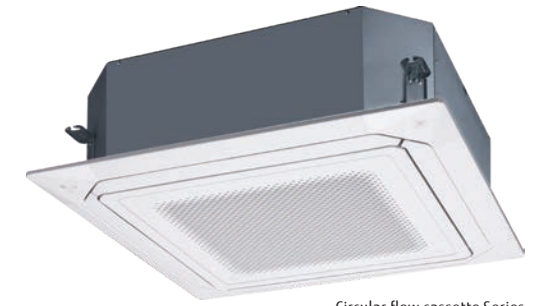

Comfortable room air conditioning without airflow sensation

Circular flow cassette blows air in all directions at a uniform temperature.



Individual airflow direction control to prevent people from being exposed to airflow



Energy-saving operation when unattended, in conjunction with an Occupancy sensor.

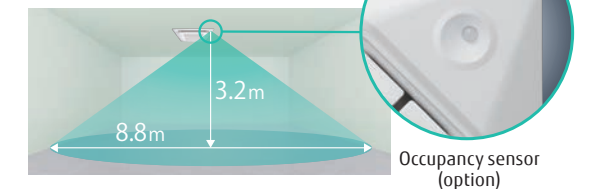



Large buildings

For Commercial use

Fujitsu General offers modular VRF systems that pursue high efficiency, comfort, design flexibility, ease of installation, and reliability for high-rise buildings.



Abundant lineup optimized for the operating environment

The VRF system meets a variety of needs, including energy-saving models and models with compatibility to outdoor temperatures of up to 46°C.

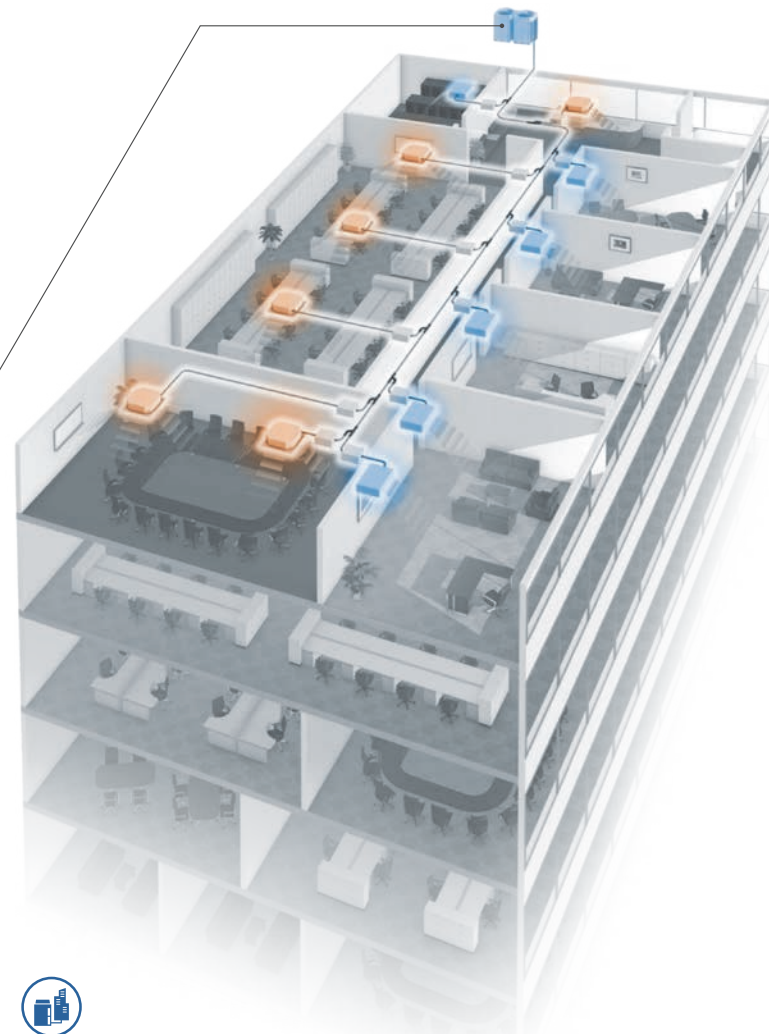

VRF VR-IV

Smart, cutting-edge design Extensive lineup from 8 HP to 48 HP with the capacity ratio of indoor units connectable up to 150%.

34 models with 8 to 48 HP

- Space saving combination: 21 models from 8 to 48 HP
- Energy efficient combination: 13 models from 16 to 44 HP

VRF V-IV

34 models from 8 to 48 HP

- Space saving combination: 21 models from 10 to 48 HP
- Energy efficient combination: 13 models from 16 to 46 HP



Height difference up to 110 m

The height difference between the outdoor unit and the indoor unit is normally 50 m for the V-IV Series, but can be extended to 110 m by installing the Pressure sensor kit.

* Can only be connected to the V-IV Series



Centralized control

Not only indoor units in the building, but also facilities such as ventilation can be controlled easily by anyone



System controller (UTY-APGXZ1)
System controller Lite (UTY-ALGXZ1 & UTY-PLGXX2)

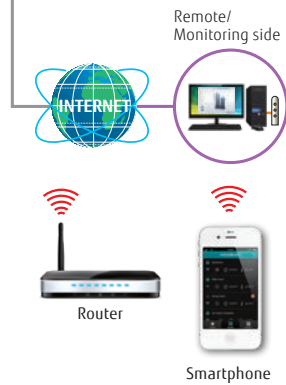

VRF indoor units



Facilities

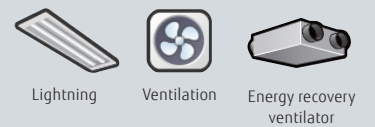

Linkage with various BMS

Linking with MODBUS®, BACnet®, KNX® and other interfaces allows centralized control of equipment other than air conditioning.

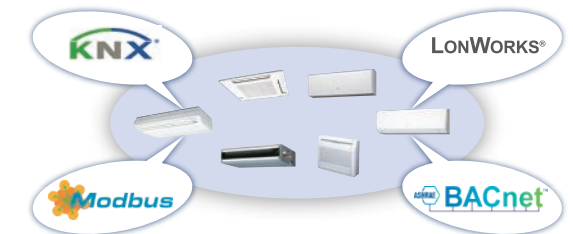

High system flexibility

The industry-leading high static pressure, long pipe design, and connection capacity enable flexible installation on each floor and installation of various indoor units.

82* Pa
*: V-IV Series, 80Pa for VR-IV Series

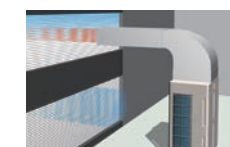

Installation example

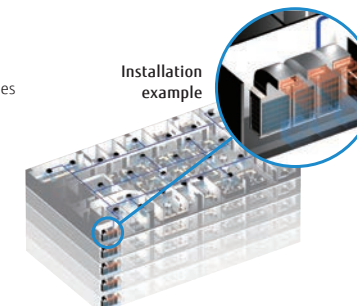

Prompt service support

Web monitoring tool and System controller remotely monitor the air conditioning of the entire building. Self-diagnosis in cooperation with the management company enables quick response in case of an emergency.

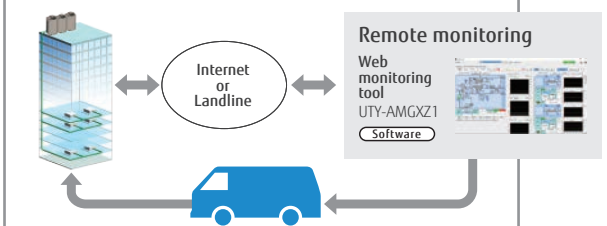

Residences

For Apartments & Houses

From the living room, where the whole family relaxes, to bedrooms, children's rooms and other small rooms, Fujitsu General has designed systems suited to spaces that reflect the rhythm of life.



 A variety of indoor units to suit the characteristics of each room



For Living & Dining room

Cool beauty design Series
This series features a special European-style design. The light, elegant and three-dimensional expression achieved by the curved surface is beautiful from all angles.

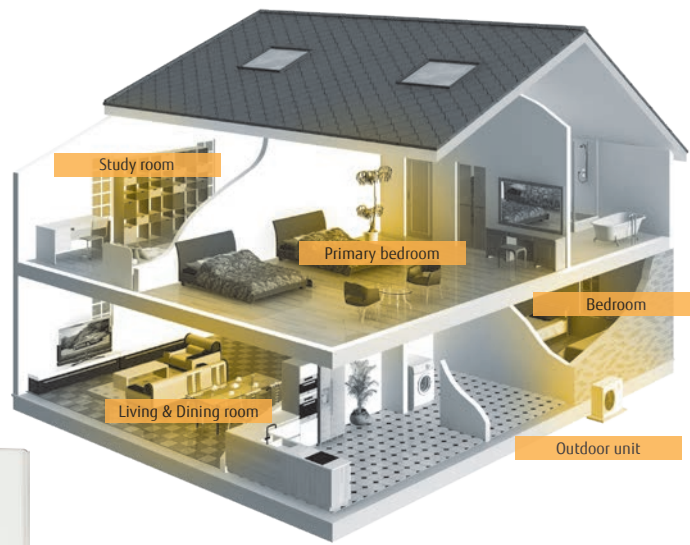

Outdoor units suitable for residential environments

 **R32 Multi-split type released**

Models are now available with environment-friendly R32 refrigerant. A number of products with improved external design have been added to the indoor unit lineup.

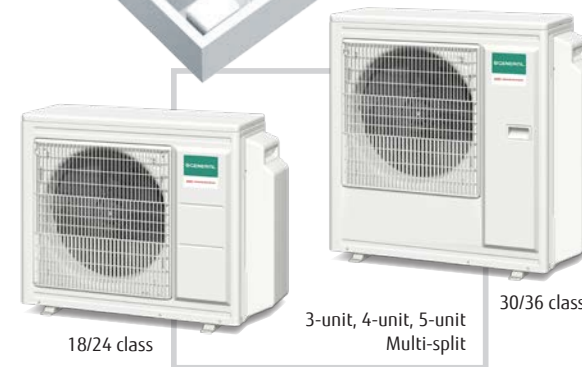
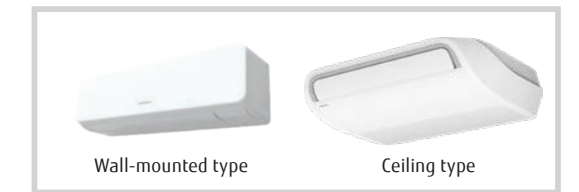

For Primary bedrooms or Living rooms

Good Design Award winning, Quiet Series
High performance, low noise with emphasis on design



For Large rooms

Standard & Comfort Series
The basic functions and powerful, comfortable airflow volume controls are optimal for large spaces.



For Bedrooms or Home offices

Standard & ECO Range Series
High performance and compact design suitable for bedrooms, home offices and other small spaces



Operation from anywhere

With a single smartphone, you can check the operating status of not only your home air conditioner, but also the air conditioners in your second house or in your parents' house (up to 24 air conditioners).

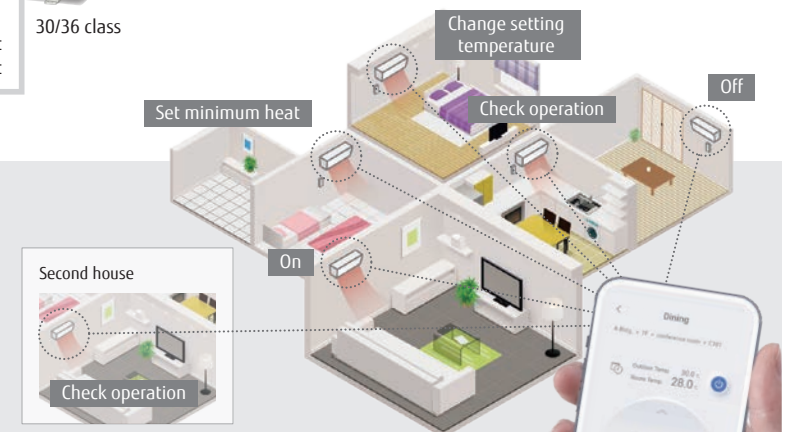

With the WLAN adapter and the AIRSTAGE Mobile app, you can control the heating and cooling of your home anytime, anywhere.

Light Commercial & Residential SPLIT & MULTI-SPLIT

Energy saving design to provide a comfortable indoor environment while being environment-friendly.

These are air conditioners that are both user-friendly and environment-friendly. Fujitsu General air conditioners cater to a wide range of needs, from living rooms, bedrooms, stores, small offices, through to hotels.

SPLIT

- Refrigerant R32 models
 - Wall-mounted type
 - Cassette
 - Duct
 - Floor
 - Ceiling
- Refrigerant R410A models
 - Duct

MULTI-SPLIT

- Refrigerant R32 models
 - 2-unit to 5-unit Multi-split
 - Simultaneous Multi-split Twin/Triple
- Refrigerant R410A models
 - 6-unit Multi-split
 - Simultaneous Multi-split Twin/Triple/Double Twin



SPLIT & MULTI-SPLIT

Light Commercial &
Residential



Light Commercial & Residential SPLIT

- S-004 Split Overview
- S-006 Indoor Units Lineup
- S-008 Features
- S-013 Features Explanation
- S-050 Wall-mounted W-LAN Adapter Option Models Specifications
- S-052 ECO Series Lineup Specifications
- S-056 Feature Summary



Refrigerant R32 models

Wall-mounted type – Built in W-LAN adapter model

- S-014 Designer Series
 - High Spec & Design
 - Cool Beauty Design
- S-018 Standard Series
 - High-Efficiency & Comfort

Wall-mounted type

- S-020 Standard Series
 - High-Efficiency & Large Rooms
- S-024 ECO Series
 - Compact Size
 - Comfort for Large Rooms

Cassette

- S-028 Compact 4-way Flow Series – Compact Size
- S-030 Circular Flow Series – Comfort for Large Rooms

Duct

- S-032 Slim Duct – Slim Design
- S-034 Medium Static Pressure Duct
 - High-Efficiency & Comfort
 - Compact Size
 - Standard
- S-040 High Static Pressure Duct

Floor, Ceiling

- S-046 Floor – Compact Size
- S-048 Ceiling



Refrigerant R410A models

Duct

- S-042 High Static Pressure Duct
- S-044 Big Duct



Split Overview

Fujitsu General provides its customers with 5 types and 149 models of air conditioning systems perfect for various customer applications and layouts. Added to this lineup recently are the environment-friendly R32 refrigerant models.



Wall-mounted type, Designer Series, Cool Beauty Design



Ceiling



Wall-mounted type

Simple and easy to install, all models, are expertly designed to control airflow and save energy. The design, with its flat and simple appeal, perfectly matches room interiors. Many of the models in the lineup adopt the new environmentally friendly R32 refrigerant.



Duct

The main unit is hidden in the wall, making the room look neat and tidy. Mini Duct and Slim Duct models are also available for installation in narrow spaces between beams or above the ceiling. Large models, suitable for air conditioning vast spaces, allow multiple outlets to be installed in just one unit, and are perfect for atypical room layouts.



Cassette

The Cassette type, which blends in perfectly with the interior design, blows air in all four directions to create an even air-conditioning for the entire space. We have a variety of series including Compact models with a uniquely designed panel to match grid ceilings, and Circular Flow models that send airflow in a 360° direction.



Floor

The compact and slim design makes this model suitable for installation in commercial as well as residential buildings. This model is also recommended as a heating device because it delivers a warm airflow from both the top and bottom outlets.



Ceiling

As with the wall-mounted unit, ceiling installation is very easy, and the unit's thin structure with a height of just 240 mm allows neat installation. The powerful airflow that can reach far away from the wide outlet is perfect for large meeting rooms, audiovisual rooms, and other rectangular spaces with a lot of depth.

Indoor Units Lineup



FUJITSU GENERAL (Euro) GmbH participates in the ECP program for AC. Check ongoing validity of certificate: www.eurovent-certification.com

Type	Series	Refrigerant	Model	Class														
				7	9	12	14	18	22	24	30	36	45	54	60	72	90	
Wall-mounted type Built in W-LAN adapter model	Designer Series High Spec & Design	R32	NEW	ASHG07KGTF	ASHG09KGTF	ASHG12KGTF	ASHG14KGTF											
	Designer Series Cool Beauty Design	R32	NEW	ASHG07KETF ASHG07KETF-B	ASHG09KETF ASHG09KETF-B	ASHG12KETF ASHG12KETF-B	ASHG14KETF ASHG14KETF-B											
	Standard Series High-Efficiency & Comfort	R32	NEW	ASHG07KMCF	ASHG09KMCF	ASHG12KMCF	ASHG14KMCF											
Wall-mounted type	Standard Series High-Efficiency & Large Rooms	R32					ASHG18KMTE		ASHG24KMTE									
	Standard Series High-Efficiency & Large Rooms	R32	NEW							ASHH30KMTB	ASHH36KMTB							
	ECO Series Compact Size	R32		ASHG07KPCE	ASHG09KPCE	ASHG12KPCE												
	ECO Series Comfort for Large Rooms	R32					ASHG18KLCA		ASHG24KLCA									
	Designer Series High Spec & Design	R32		ASHG07KGTE	ASHG09KGTE	ASHG12KGTE	ASHG14KGTE											
	Designer Series Cool Beauty Design	R32		ASHG07KETE ASHG07KETE-B	ASHG09KETE ASHG09KETE-B	ASHG12KETE ASHG12KETE-B	ASHG14KETE ASHG14KETE-B											
	Standard Series High-Efficiency & Comfort	R32		ASHG07KMCE	ASHG09KMCE	ASHG12KMCE	ASHG14KMCE											
Cassette	Compact 4-way Flow Series Compact Size	R32			AUXG09KVLA	AUXG12KVLA	AUXG14KVLA	AUXG18KVLA	AUXG22KVLA	AUXG24KVLA								
	Circular Flow Series Comfort for Large Rooms	R32	18/22/24 30/36/45/54					AUXG18KRLB	AUXG22KRLB	AUXG24KRLB	AUXG30KRLB	AUXG36KRLB	AUXG45KRLB	AUXG54KRLB				
Duct	Slim Duct	R32	09/12/14 18		ARXG09KLLAP	ARXG12KLLAP	ARXG14KLLAP	ARXG18KLLAP										
	Medium Static Pressure Duct High-Efficiency & Comfort	R32	22/24 30/36/45/54 NEW						ARXH22KMTAP	ARXH24KMTAP	ARXH30KMTAP	ARXH36KMTAP	ARXH45KMTAP	ARXH54KMTAP				
	Medium Static Pressure Duct Compact Size	R32	12/14 18/22/24/30 36/45/54			ARXG12KHTAP	ARXG14KHTAP	ARXG18KHTAP	ARXG22KHTAP	ARXG24KHTAP	ARXG30KHTAP	ARXG36KHTAP	ARXG45KHTAP	ARXG54KHTAP				
	Medium Static Pressure Duct Standard	R32							ARXG22KMLB	ARXG24KMLA	ARXG30KMLA	ARXG36KMLA	ARXG45KMLA					
	High Static Pressure Duct	R32												ARXG45KHTB	ARXG54KHTB			
		R410A														ARHG60LHTA		
Big Duct	R410A														ARHG72LHTA	ARHG90LHTA		
Floor Compact & Comfort	R32			AGHG09KVCA	AGHG12KVCA	AGHG14KVCA												
Ceiling	R32	18/22 24/30 36/45/54						ABHG18KRTA	ABHG22KRTA	ABHG24KRTA	ABHG30KRTA	ABHG36KRTA	ABHG45KRTA	ABHG54KRTA				

Features

High-Efficiency

ALL DC All DC Inverter Technology



DC twin-rotary compressor

A high-efficiency 2-cylinder rotary compressor with a DC inverter optimizes the internal structure of the compressor to achieve higher energy efficiency compared to similar compressors.

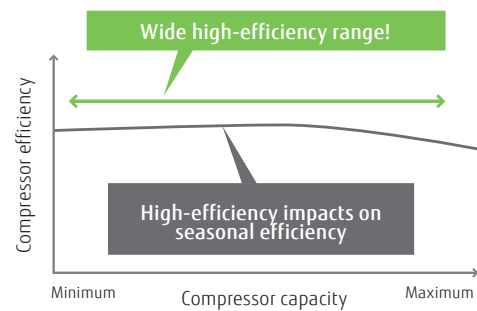

DC fan motor

The DC fan motor produces high power, a wide operating range, and high-efficiency.

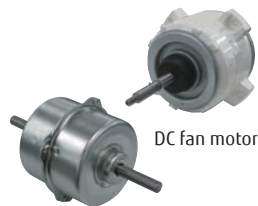

Sine-wave DC inverter control

High-efficiency operation is realized by using sine-wave DC inverter control.

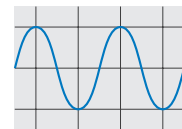

Heat Exchanger for Wall-mounted type

High-density multipath heat exchanger

Thinner and denser heat exchangers and multipath efficiency technology have substantially improved heat exchange performance.

High-performance sub-cool heat exchanger

A counter-type bypass circuit has been incorporated to achieve a higher performance. (Large multi-split type, VRF)

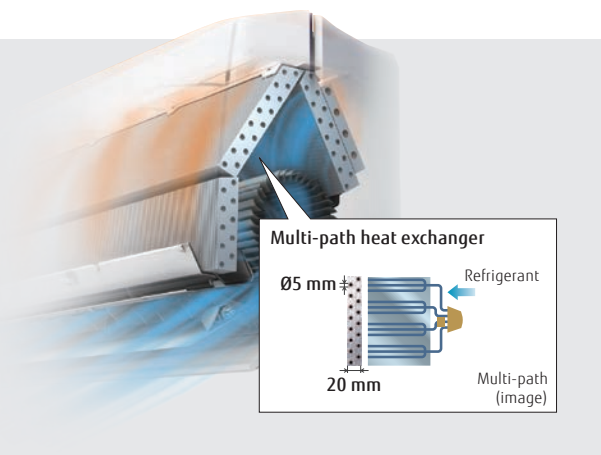

High Energy Saving

Occupancy sensor control

The Occupancy sensor monitors the movements of people in a room and operates the air conditioner at a lower capacity when people leave the room. When people come back to the room, it automatically returns to the previous operating mode.

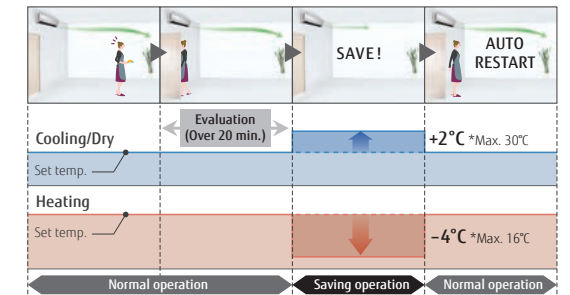

Economy operation

Limits maximum operation, reducing the power consumption, and thereby suppressing the maximum load.

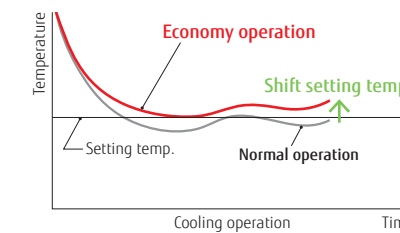

Setting temperature range limitation

The minimum and maximum temperature range can be set giving further energy savings while considering the comfort of the occupants.

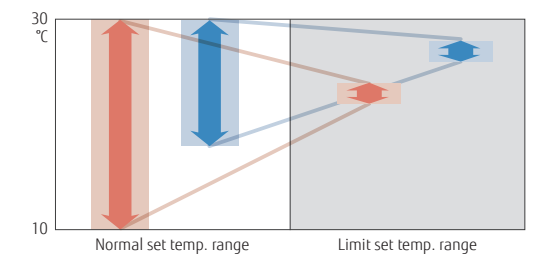

Set temperature auto return

- The set temperature automatically returns to the previously set temperature.
- The time range in which the set temperature can be changed is from 10 to 120 minutes.

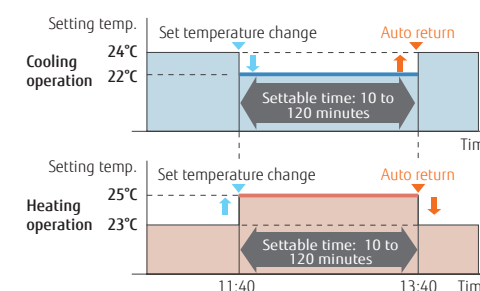

Auto-off timer

- The indoor unit is automatically turned off when it reaches a preset operating time frame.
- The time frame of the Auto-off timer can be flexibly scheduled.
- Auto-off times can be set from 30 to 240 minutes.

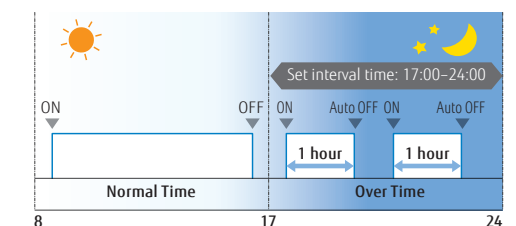

More Comfort



Powerful operation

Maximum airflow and maximum compressor speed are maintained for the period necessary to reach the set temperature quickly.

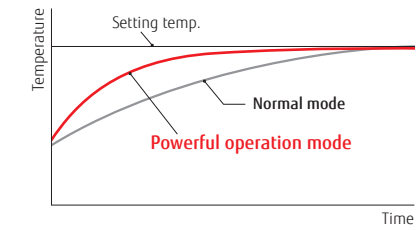

10°C heat

After a person has left the room, the system switches to minimum heating operation to maintain the room temperature. (Maintained at 10°C)

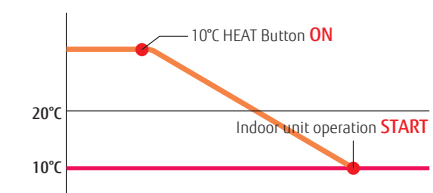

Power diffuser

These three technologies enable precise wind direction control and improve ventilation efficiency; our airflow control offers a more comfortable environment.

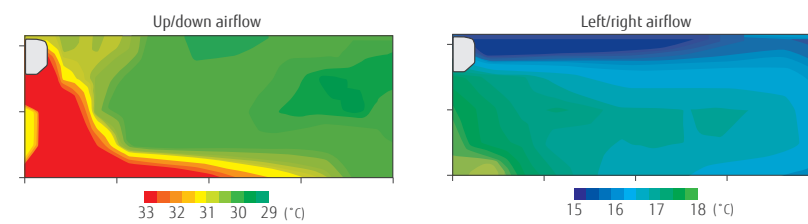

Wireless LAN control

Users can control their air conditioners from anywhere with their mobile devices while out or on the move.

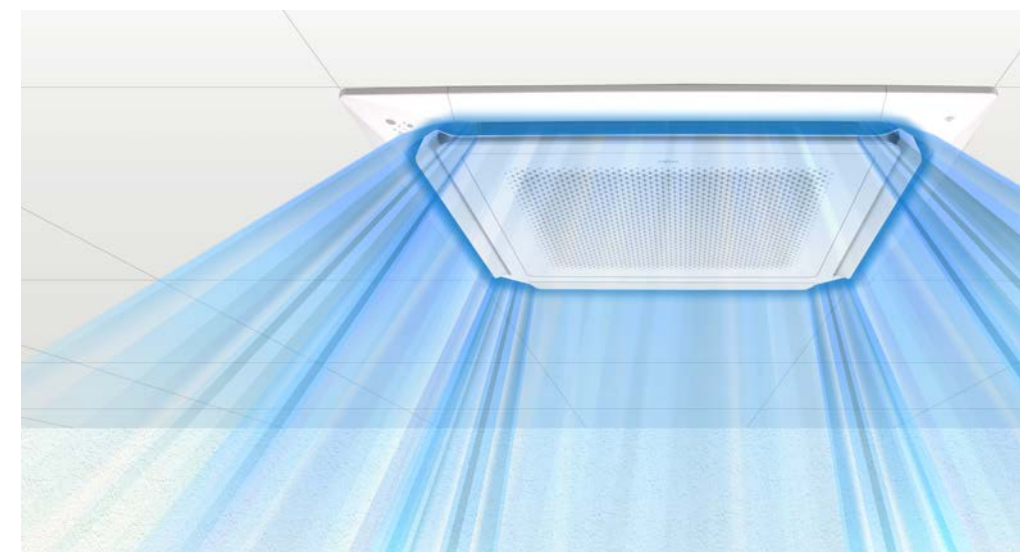
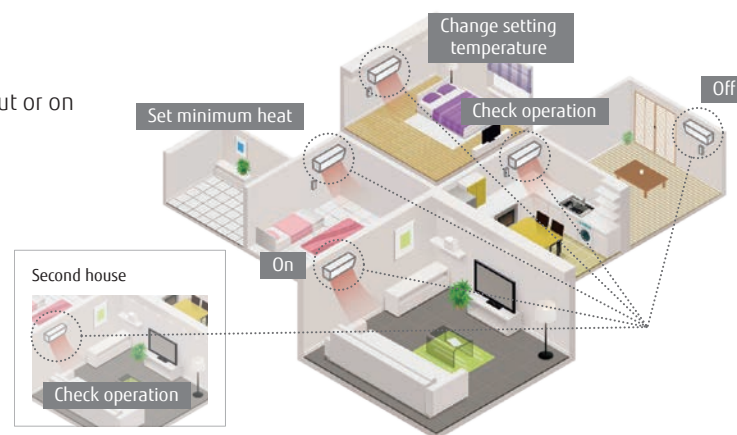

Uniform air conditioning

Circular airflow to achieve uniform air conditioning without temperature unevenness in workspaces



Quiet and Comfort Control



Low Noise Technology

Outdoor unit fan

Outdoor unit fan design with a small separation vortex, minimized air volume by fan control, and top-class low noise

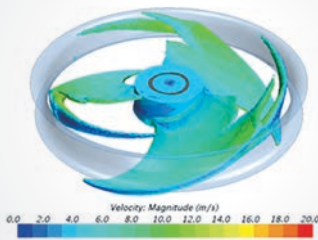

Air stabilizer in Duct

Low-noise duct structure with a built-in air stabilizer

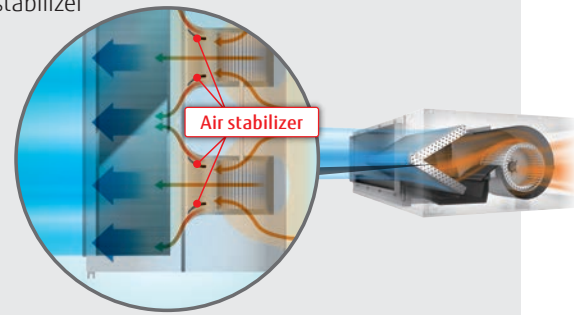

Outdoor unit low noise operation

Users can choose low noise levels, depending on the installation environment. Operation time can be set by timer.

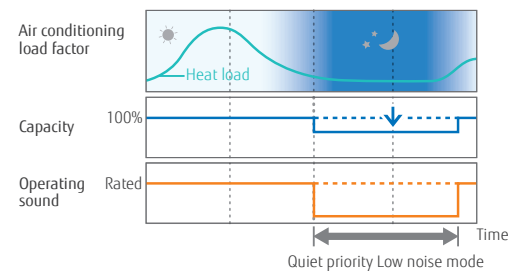

Auto changeover

In an auto setting, the system automatically switches between cooling and heating modes according to the set temperature and room temperature.

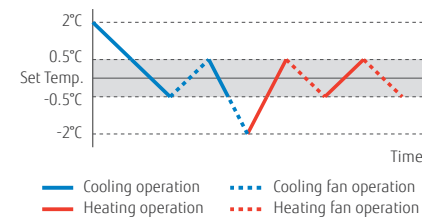

Fresh air intake for Cassette, Duct, Ceiling

Fresh air is taken in by a fan connected to an external control unit.



Feature Explanation

Energy-Saving Features

- Save** **Save Occupancy sensor**
The Occupancy sensor detects the movement of people in the room and determines whether to switch to energy saving operation.
- Save+Stop** **Occupancy sensor control**
The Occupancy sensor (option) detects movement of people in the room and decides whether to save energy or stop the unit.
- Economy** **Economy operation**
The thermostat setting is adjusted automatically according to the room temperature to avoid unnecessary cooling or heating.
- Set Temp.** **Setting temperature range limitation**
Sets the minimum and maximum limits on room temperature to establish the right balance between energy saving and a comfortable environment.
- Return** **Set temperature auto return**
The setting temperature automatically returns to the previously set temperature.

Features for Comfort

- Diffuser** **Power diffuser**
An additional louver that opens based on input from monitoring sensors to quickly enhance immediate comfort needs.
- Low Noise** **Outdoor unit low noise operation**
The noise level of the outdoor unit can be selected.
- Auto Changeover** **Powerful operation**
Operation at maximum air flow and compressor speed, that quickly makes the room comfortable.
- Double** **Double swing automatic**
Complex swing action of the louver enables automatic swing in both the left/right and up/down directions.
- Auto Changeover** **Auto changeover**
The unit automatically switches between heating and cooling modes based on the temperature setting and the room temperature.
- Adjust** **Automatic fan speed**
A micro-computer automatically adjusts the airflow to follow the changes in room temperature.
- Duct** **Connectable fresh air duct**
Outside air can be introduced by attaching a locally purchased duct to the fresh air knockout and an optional part.
- Intake** **Fresh air intake**
Fresh air can be taken in by a fan connected to an external control unit.
- Individual** **Individual airflow direction control**
Each louver of a 4-way Cassette type can be controlled individually to provide comfortable airflow.
- Up/Down** **UP/DOWN swing louver**
The vertical louver automatically swings up and down.
- Restart** **Auto restart**
In the event of a temporary power failure, the air conditioner will automatically restart in the same operating mode as before, once the power supply is restored.
- Distributing** **Connectable distributing duct**
Locally purchased branch ducts can be attached to the systems to distribute the airflow.

Convenience Features

- Auto OFF** **Auto-off timer**
Automatically stops operation when a fixed time has elapsed from the start of operation.
- Sleep** **Sleep timer**
A micro-computer gradually changes the room temperature automatically to promote a comfortable night's sleep.
- Program** **Program timer**
This digital timer allows selection of one of four options: ON, OFF, ON + OFF, or OFF + ON.
- Weekly** **Weekly timer**
Different ON-OFF times can be set for each day.
- +Setback** **Weekly & Temperature setback timer**
Weekly & Temperature setback timer can set the temperature for 2-time spans and for each day of the week.
- Filter** **Filter sign**
Indicates the filter cleaning period by blinking.
- Error** **External error output**
- On/Off** **External ON/OFF input**
- LAN** **Wireless LAN control**
The optional WLAN adapter enables the air conditioner to be operated by smartphone or tablet PC from outside the home.
- Multi Control** **Multi System Control**
Operation using "Lead Lag Operation", "Back up operation", "Lag Operation" is possible. (Page C-011)
- Special Cooling** **Special Cooling**
Special Cooling is a function that supports the operation of "Multi System Control".

Clean Features

- ION** **Ion deodorization filter**
The filter deodorizes by powerfully decomposing absorbed odors using the oxidizing and reducing effects of ions generated by an ultra-fine-particle ceramic.
- AF** **Apple-catechin filter**
The Apple-catechin filter uses static electricity to clean fine particles and dust from the air.
- Washable** **Washable panel**
Since the front panel is easy to remove, maintenance is also easy.
- Silver Ion** **Silver Ion Filter**
The Silver ion filter helps to keep indoor air free from viruses, bacteria and molds.

Installation / Support

- Adjust** **Automatic airflow adjustment**
Automatically detects required airflow in each application case and adjusts the volume.
- Drain Pump** **Drain pump as standard**
- Refrigerant Cycle** **Refrigerant cycle monitor**
The values of each sensor and actuator can be displayed, and the status of the refrigeration cycle can be checked.
- Blue Fin** **Blue fin**



Wall-mounted type

Built-in W-LAN adapter model
Designer Series
High Spec & Design



High energy saving

Top class high efficiency is achieved by high efficient lambda-shaped heat exchanger, large cross flow fan and new refrigerant.

Rank **A+++**
09, 12 models
SEER 8.9
09 model
SCOP 5.3
07 model

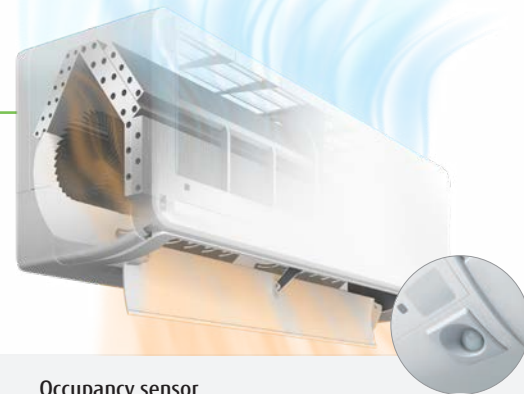

Hybrid-heat exchanger

The large hybrid heat exchanger has greatly improved the heat exchange efficiency to achieve top-level SEER and SCOP.

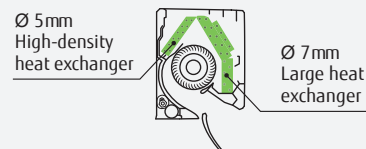

Ø107 Large cross-flow fan

The large-diameter fan generates air volume efficiently even at reduced power.

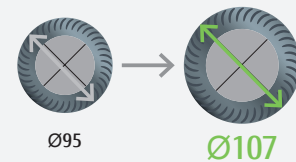

Occupancy sensor

The Occupancy sensor monitors the movements of people in a room and operates the air conditioner at a lower capacity when people leave the room. When people come back to the room, it automatically returns to the previous operating mode.

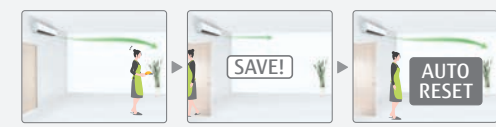

Comfortable airflow & Quiet operation

The large louver and the new air-blowing structure create a comfortable air flow that spreads all the way down to the user's feet with quiet operation.



Smart device control

With the WLAN adapter installed in the air conditioner, you can control it from anywhere with your smart device.

* For more information about smart device control, please refer to the page C-018.

You need to install the AIRSTAGE Mobile app on your smart device in order to control the air conditioner.

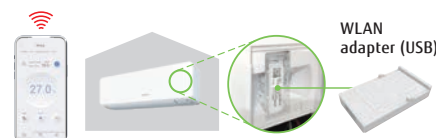

Easy access to the flare pipe connection

Installation when left outlet piping is easier by removable under cover of the indoor unit chassis. Installation when center outlet piping is easier by design change of wall hook bracket.

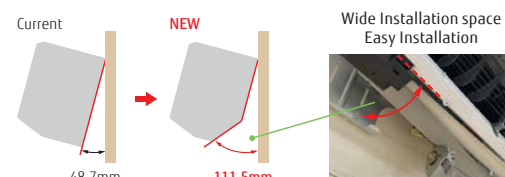

Model: ASHG07KGTF / ASHG09KGTF / ASHG12KGTF / ASHG14KGTF



Specifications

Model name	Indoor unit		ASHG07KGTF	ASHG09KGTF	ASHG12KGTF	ASHG14KGTF
	Outdoor unit		AOHG07KGCB	AOHG09KGCB	AOHG12KGCB	AOHG14KGCB
Power Source	Single phase, ~230 V, 50 Hz					
Capacity	Cooling	kW	2.0 (0.9-3.2)	2.5 (0.9-3.4)	3.4 (0.9-4.1)	4.2 (0.9-4.5)
	Heating	kW	2.5 (0.9-5.2)	2.8 (0.9-5.4)	4.0 (0.9-6.1)	5.4 (0.9-6.4)
Input Power	Cooling/Heating		0.400/0.500	0.555/0.560	0.805/0.910	1.175/1.350
EER	Cooling	W/W	5.00	4.50	4.22	3.57
	Heating	W/W	5.00	5.00	4.40	4.00
Pdesign	Cooling/Heating (-10°C)		2.0/2.3	2.5/2.4	3.4/2.5	4.2/4.0
SEER	Cooling	W/W	8.10	8.90	8.70	7.90
	Heating (Average)	W/W	5.30	5.20	5.20	4.50
Energy Efficiency Class	Cooling		A++	A+++	A+++	A++
	Heating (Average)		A+++	A+++	A+++	A+
Max. Operating Current	Cooling/Heating	A	6.5/9.0	6.5/9.0	6.5/9.0	9.0/10.5
	Cooling	kWh/a	86	98	137	186
Annual Energy Consumption	Heating	kWh/a	606	645	673	1,242
	Moisture Removal	l/h	1.0	1.3	1.8	2.1
Sound Pressure Level	Indoor (Cooling)	H/M/L/Q	38/33/29/19	40/34/29/19	40/35/30/19	43/36/30/20
	Indoor (Heating)	H/M/L/Q	41/35/31/21	42/36/31/21	42/38/33/21	44/39/33/24
	Outdoor (Cooling/Heating)	High	46/46	46/48	50/50	50/50
Sound Power Level	Indoor (Cooling/Heating)	High	54/56	55/57	56/58	57/59
	Outdoor (Cooling/Heating)	High	61/62	61/63	65/66	65/66
	Airflow Rate	Indoor/Outdoor (Cooling)	High	650/1,610	700/1,610	700/1,680
Net Dimensions H x W x D	Indoor	mm	270 × 834 × 215	270 × 834 × 215	270 × 834 × 215	270 × 834 × 215
	Outdoor	mm	542 × 799 × 290	542 × 799 × 290	542 × 799 × 290	542 × 799 × 290
Weight	Indoor	kg	10	10	10	10
	Outdoor	kg	30	30	31	32
Connection Pipe Diameter (Liquid/Gas)	mm	6.35/9.52				
Drain Hose Diameter (I.D./O.D.)	mm	13.8/15.0 to 16.8				
Max. Pipe Length (Pre-Charge)	m	20 (15)				
Max. Height Difference		15				
Operating Range	Cooling	°CDB	-10 to 46			
	Heating	°CDB	-15 to 24			
Refrigerant	Type (Global Warming Potential)		R32 (675)			
	Charge	kg (CO2eq-T)	0.75 (0.506)	0.75 (0.506)	0.85 (0.574)	0.85 (0.574)

Optional parts

* For optional parts compatibility of Intesis devices, please refer to the optional parts compatibility list page C-048.

Compact wired remote controller:	UTY-RCRGZ1	External switch controller:	UTY-TERX	Network Converter for single split (DC power supply type):	UTY-VTGX
Wired remote controller (touch panel):	UTY-RNRGZ5	Communication kit:	UTY-TWRXZ2	Network Converter for single split (AC power supply type):	UTY-VTGXV
Wired remote controller:	UTY-RLRG	External input and output PCB*1:	UTY-XCSXZ2	Silver Ion filter:	UTR-FA16-5
Simple remote controller (without operation mode):	UTY-RHRG	External connect kit:	UTY-XWZX		
Simple remote controller:	UTY-RSRG		UTY-XWZXZ5		

*1 It is required when 2 or more external input and output ports are used.

Dimensions

(Unit: mm)

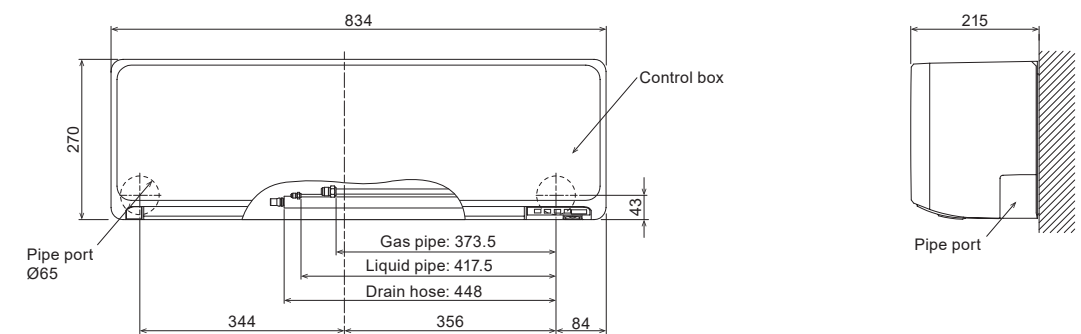

Wall-mounted type

Built-in W-LAN adapter model
Designer Series
Cool Beauty Design



Cool beauty design

We have designed this series exclusively for the European market. The exterior design harmonizes beautifully with any decor and adds comfortable elegance to the room. The light, elegant and three-dimensional expression achieved by the curved surface is beautiful from any angle.



CMF: COLOR MATERIAL FINISH

The texture of the front panel expresses the craftsmanship of Europe, and changes its expression with the changing light of the day.

High energy saving

Top class high efficiency is achieved by high efficient lambda-shaped heat exchanger, large cross flow fan and new refrigerant.

Rank Cooling*1: **A++**
Rank Heating*2: **A+**

SEER **7.4** *1
SCOP **4.4** *2

*1: 07/09 models *2: 12 model

Hybrid-heat exchanger

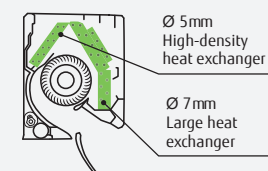

Ø107 Large cross-flow fan



Comfortable airflow & Quiet operation

The large louver and the new air-blowing structure create a comfortable air flow that spreads all the way down to the user's feet with quiet operation.

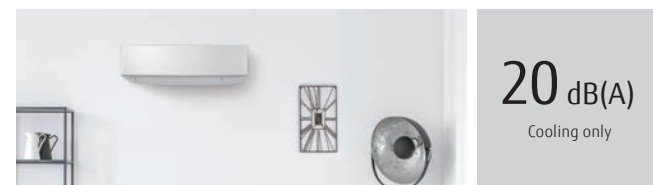

20 dB(A)
Cooling only

Smart device control

With the WLAN adapter installed in the air conditioner, you can control it from anywhere with your smart device.

* For more information about smart device control, please refer to the page C-018.

You need to install the AIRSTAGE Mobile app on your smart device in order to control the air conditioner.

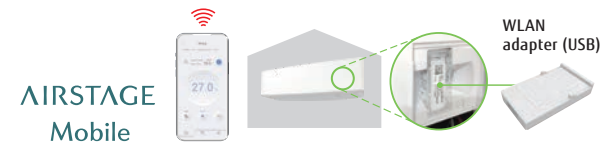

Model: ASHG07KETF / ASHG09KETF / ASHG12KETF / ASHG14KETF (Peal white X White)
ASHG07KETF-B / ASHG09KETF-B / ASHG12KETF-B / ASHG14KETF-B (Silver X Dark gray)



Specifications

Model name	Indoor unit		Outdoor unit		ASHG07KETF ASHG07KETF-B	ASHG09KETF ASHG09KETF-B	ASHG12KETF ASHG12KETF-B	ASHG14KETF ASHG14KETF-B
					AOHG07KETA	AOHG09KETA	AOHG12KETA	AOHG14KETA
Power Source					Single phase, ~230 V, 50 Hz			
Capacity	Cooling	kW			2.0 (0.9 - 3.0)	2.5 (0.9 - 3.2)	3.4 (0.9 - 3.9)	4.2 (0.9 - 4.4)
	Heating				2.5 (0.9 - 3.4)	2.8 (0.9 - 4.0)	4.0 (0.9 - 5.3)	5.4 (0.9 - 6.0)
Input Power	Cooling/Heating	kW			0.450/0.555	0.630/0.620	0.935/0.960	1.220/1.410
EER	Cooling				4.43	3.97	3.65	3.44
COP	Heating			4.52	4.52	4.17	3.83	
Pdesign	Cooling/Heating (-10°C)	kW			2.0/2.3	2.5/2.4	3.4/2.5	4.2/4.0
SEER	Cooling				7.40	7.40	7.30	6.90
SCOP	Heating (Average)			4.10	4.10	4.40	4.10	
Energy Efficiency Class	Cooling			A++	A++	A++	A++	
	Heating (Average)			A+	A+	A+	A+	
Max. Operating Current	Cooling/Heating	A			6.5/9.0	6.5/9.0	6.5/9.0	6.5/9.0
Annual Energy Consumption	Cooling				95	118	163	213
	Heating			785	819	795	1,367	
Moisture Removal		l/h			1.0	1.3	1.8	2.1
Sound Pressure Level	Indoor (Cooling)	H/M/L/Q			38/33/29/20	40/34/29/20	40/35/30/20	43/36/30/20
	Indoor (Heating)	H/M/L/Q			41/35/31/22	42/36/31/22	42/38/33/22	44/39/33/24
Sound Power Level	Outdoor (Cooling/Heating)	High			46/46	46/46	50/50	50/50
	Indoor (Cooling/Heating)	High			54/56	55/57	55/58	57/59
Airflow Rate	Indoor/Outdoor (Cooling)	High			650/1,650	700/1,650	700/1,700	770/1,680
	Indoor/Outdoor (Heating)	High			720/1,450	750/1,450	770/1,470	800/1,580
Net Dimensions	Indoor			295 × 950 (wall side: 840) × 230				
H x W x D	Outdoor			541 × 663 × 290	541 × 663 × 290	541 × 663 × 290	542 × 799 × 290	
Weight	Indoor			11	11	11	11.5	
	Outdoor			23	23	25	31	
Connection Pipe Diameter (Liquid/Gas)					6.35/9.52	6.35/9.52	6.35/9.52	6.35/9.52
Drain Hose Diameter (I.D./O.D.)					13.8/15.0 to 16.8	13.8/15.0 to 16.8	13.8/15.0 to 16.8	13.8/15.0 to 16.8
Max. Pipe Length (Pre-Charge)					20 (15)	20 (15)	20 (15)	20 (15)
Max. Height Difference					15	15	15	15
Operating Range	Cooling			-10 to 46	-10 to 46	-10 to 46	-10 to 46	
	Heating			-15 to 24	-15 to 24	-15 to 24	-15 to 24	
Refrigerant	Type (Global Warming Potential)			R32 (675)	R32 (675)	R32 (675)	R32 (675)	
	Charge			kg (CO2eq-T)	0.6 (0.405)	0.6 (0.405)	0.7 (0.473)	0.85 (0.574)

Optional parts

* For optional parts compatibility of Intesis devices, refer to the optional parts compatibility list Page C-048.

Compact wired remote controller:	UTY-RCRGZ1	Communication kit:	UTY-TWRXZ2	Network Converter for single split (DC power supply type):	UTY-VTGX
Wired remote controller (touch panel):	UTY-RNRGZ5	External input and output PCB*1:	UTY-XCSXZ2	Network Converter for single split (AC power supply type):	UTY-VTGVV
Wired remote controller:	UTY-RLRG	External connect kit:	UTY-XWZX	Silver Ion filter:	UTR-FA16-5
Simple remote controller (without operation mode):	UTY-RHRG		UTY-XWZXZ5		
Simple remote controller:	UTY-RSRG	External switch controller:	UTY-TERX		

*1 It is required when 2 or more external input and output ports are used.

Dimensions

(Unit: mm)

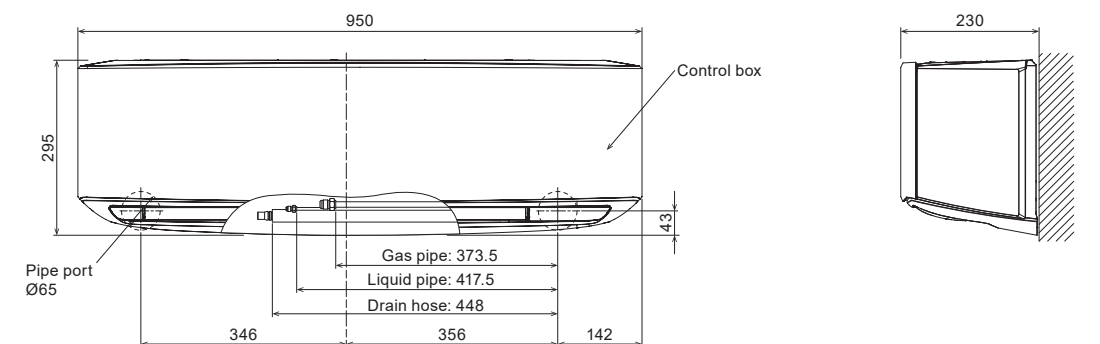

NEW

Wall-mounted type

Built-in W-LAN adapter model
Standard Series
High-Efficiency & Comfort



Slim & stylish square design

The slim and stylish square design of this indoor unit is realized by using a high-density, multipath heat exchanger and a high-efficiency wind blower.

Hybrid-heat exchanger

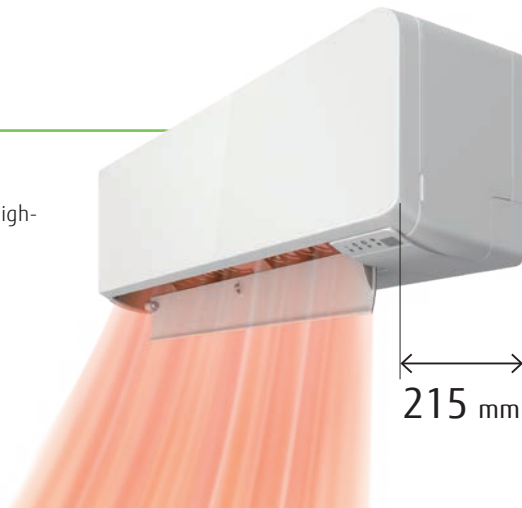
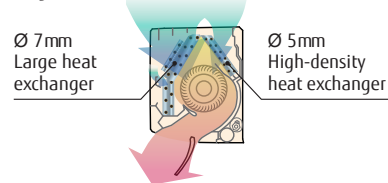

High energy saving

High-efficiency has been achieved by the lambda-shaped heat exchanger, large cross-flow fan, and the new refrigerant.

Rank Cooling A++ Heating A+

SEER 7.4 *1 SCOP 4.4 *2

*1: 07/09 models *2: 12 model

Comfortable airflow & Quiet operation

The large louver and the new air-blowing structure create a comfortable air flow that spreads all the way down to the user's feet with quiet operation.



Smart device control

With the WLAN adapter installed in the air conditioner, you can control it from anywhere with your smart device.

* For more information about smart device control, please refer to the page C-018.



Easy access to the flare pipe connection

Installation when left outlet piping is easier by removable under cover of the indoor unit chassis. Installation when center outlet piping is easier by design change of wall hook bracket.

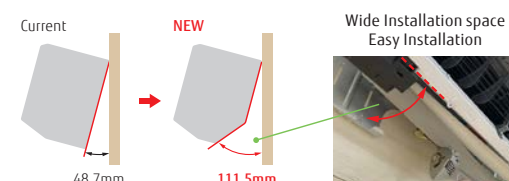

Model: ASHG07KMCF / ASHG09KMCF / ASHG12KMCF / ASHG14KMCF



Specifications

Model name	Indoor unit		ASHG07KMCF	ASHG09KMCF	ASHG12KMCF	ASHG14KMCF
	Outdoor unit		AOHG07KMCC	AOHG09KMCC	AOHG12KMCC	AOHG14KMCC
Power Source	Single phase, ~230 V, 50 Hz					
Capacity	Cooling	kW	2.0 (0.9-3.0)	2.5 (0.9-3.2)	3.4 (0.9-3.9)	4.2 (0.9-4.4)
	Heating	kW	2.5 (0.9-3.4)	2.8 (0.9-4.0)	4.0 (0.9-5.3)	5.4 (0.9-6.0)
Input Power	Cooling/Heating		0.450/0.555	0.630/0.620	0.935/0.960	1.220/1.410
	Cooling	W/W	4.43	3.97	3.65	3.44
EER	Cooling		4.52	4.52	4.17	3.83
	Heating		2.0/2.3	2.5/2.4	3.4/2.5	4.2/4.0
Pdesign	Cooling/Heating (-10°C)		7.40	7.40	7.30	6.90
	Cooling	W/W	4.10	4.10	4.40	4.10
SEER	Cooling		A++	A++	A++	A++
	Heating (Average)		A+	A+	A+	A+
SCOP	Heating (Average)		6.5/9.0	6.5/9.0	6.5/9.0	6.5/9.0
	Cooling	A	95	118	163	213
Max. Operating Current	Cooling/Heating		785	819	795	1,366
	Cooling	kWh/a	1.0	1.3	1.8	2.1
Annual Energy Consumption	Cooling		38/33/29/20	40/34/29/20	40/35/30/20	43/36/30/20
	Heating		41/35/31/22	42/36/31/22	42/38/33/22	44/39/33/24
Moisture Removal	Indoor (Cooling)	H/M/L/Q	46/46	46/46	50/50	50/50
	Indoor (Heating)	H/M/L/Q	54/56	55/57	55/58	57/59
Sound Pressure Level	Outdoor (Cooling/Heating)		High	High	High	High
	Indoor (Cooling/Heating)		High	High	High	High
Sound Power Level	Outdoor (Cooling/Heating)		High	High	High	High
	Indoor (Cooling/Heating)		High	High	High	High
Airflow Rate	Indoor/Outdoor (Cooling)		High	High	High	High
	Indoor/Outdoor (Heating)		High	High	High	High
Net Dimensions H x W x D	Indoor		mm	270 × 834 × 215	270 × 834 × 215	270 × 834 × 215
	Outdoor		mm	541 × 663 × 290	541 × 663 × 290	541 × 663 × 290
Weight	Indoor		kg	10	10	10
	Outdoor		kg	22	22	24
Connection Pipe Diameter (Liquid/Gas)			mm	6.35/9.52	6.35/9.52	6.35/9.52
Drain Hose Diameter (I.D./O.D.)			mm	13.8/15.0 to 16.8	13.8/15.0 to 16.8	13.8/15.0 to 16.8
Max. Pipe Length (Pre-Charge)			m	20 (15)	20 (15)	20 (15)
Max. Height Difference	Cooling		°CDB	-10 to 46	-10 to 46	-10 to 46
	Heating		°CDB	-15 to 24	-15 to 24	-15 to 24
Refrigerant	Type (Global Warming Potential)			R32 (675)	R32 (675)	R32 (675)
	Charge		kg (CO2eq-T)	0.6 (0.405)	0.6 (0.405)	0.7 (0.473)

Optional parts

* For optional parts compatibility of Inetis devices, refer to the optional parts compatibility list Page C-048.

Compact wired remote controller:	UTY-RCRGZ1	Communication kit:	UTY-TWRXZ2	Network Converter for single split (DC power supply type):	UTY-VTGX
Wired remote controller (touch panel):	UTY-RNRGZ5	External input and output PCB*1:	UTY-XCSXZ2	Network Converter for single split (AC power supply type):	UTY-VTGXV
Wired remote controller:	UTY-RLRG	External connect kit:	UTY-XWZX	Silver Ion filter:	UTR-FA16-5
Simple remote controller (without operation mode):	UTY-RHRG		UTY-XWZXZ5		
Simple remote controller:	UTY-RSRG	External switch controller:	UTY-TERX		

*1 It is required when 2 or more external input and output ports are used.

Dimensions

(Unit: mm)

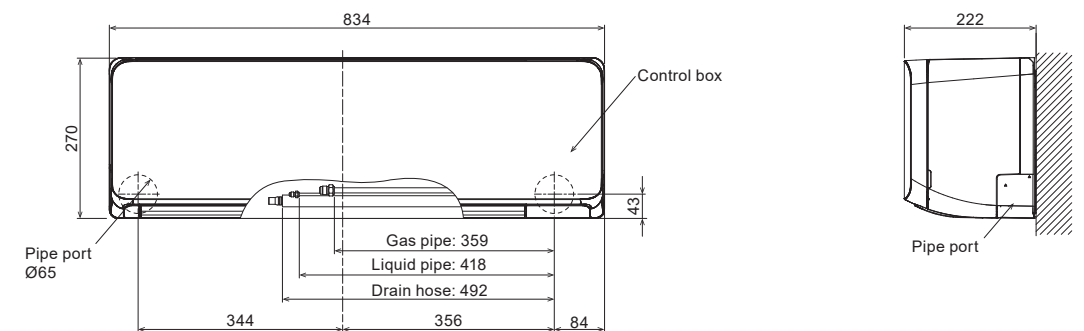

Wall-mounted type

Standard Series

High-Efficiency & Large Rooms



High energy saving

High-efficiency has been achieved by the lambda-shaped heat exchanger, large cross-flow fan, and the new refrigerant.

Rank **A++**
SEER 7.8
SCOP 4.6
*18 model

Hybrid-heat exchanger

The large hybrid heat exchanger has greatly improved the heat exchange efficiency to achieve top-level SEER and SCOP.

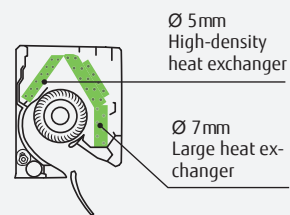

Ø107 Large cross-flow fan

The large-diameter fan generates air volume efficiently even at reduced power.

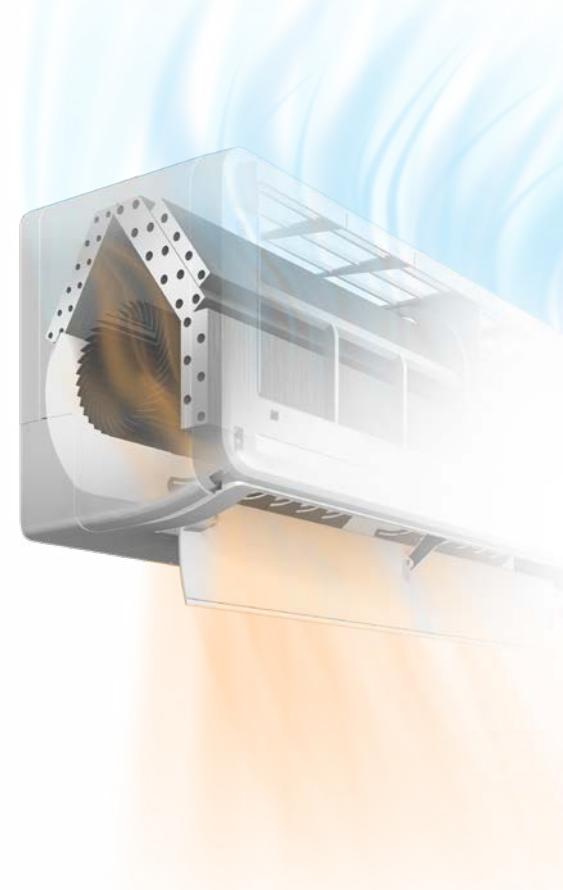
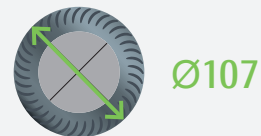

Smart device control (Option)

With the optional WLAN adapter installed in the air conditioner, you can control it from anywhere with your smart device. WLAN adapter can be installed easily without specialized installation work.

* For more information about smart device control, please refer to the page C-018.



Easy access to the flare pipe connection

Installation when left outlet piping is easier by removable under cover of the indoor unit chassis. Installation when center outlet piping is easier by design change of wall hook bracket.

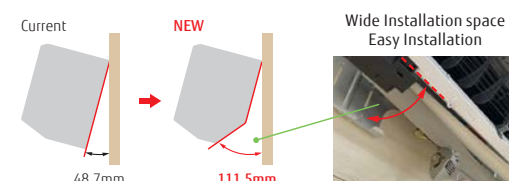

Model: ASHG18KMTE / ASHG24KMTE



Specifications

Model name	Indoor unit		Outdoor unit		ASHG18KMTE	ASHG24KMTE	
	AOHG18KMTA		AOHG24KMTA				
Power Source	Single phase, ~230 V, 50 Hz						
Capacity	Cooling	kW			5.2 (0.9-6.0)	7.1 (0.9-8.3)	
	Heating	kW			6.3 (0.9-8.7)	8.0 (0.9-10.1)	
Input Power	Cooling/Heating				1.39/1.56	2.08/1.91	
	Cooling	W/W			3.74	3.41	
COP	Heating				4.04	4.19	
	Cooling/Heating (-10°C)	kW			5.2/4.8	7.1/7.1	
SEER	Cooling	W/W			7.77	7.30	
SCOP	Heating (Average)				4.60	4.20	
Energy Efficiency Class	Cooling				A++	A++	
	Heating (Average)				A++	A+	
Max. Operating Current	Cooling/Heating				9.5/13.5	13.5/16.0	
	Cooling	kWh/a			234	340	
Annual Energy Consumption	Heating				1,460	2,362	
					1.7	2.7	
Moisture Removal	Indoor (Cooling)	H/M/L/Q			45/40/35/29	49/40/35/29	
	Indoor (Heating)	H/M/L/Q			46/40/35/29	49/40/35/29	
Sound Pressure Level	Outdoor (Cooling/Heating)	High	dB(A)			50/50	54/52
	Indoor (Cooling/Heating)	High				60/61	65/65
Sound Power Level	Outdoor (Cooling/Heating)	High			65/65	67/66	
	Indoor/Outdoor (Cooling)	High			980/2,350	1,170/3,240	
Airflow Rate	Indoor/Outdoor (Heating)	High			1,020/2,100	1,170/2,820	
	Indoor	mm			280 × 980 × 240	280 × 980 × 240	
Net Dimensions H x W x D	Outdoor	mm			632 × 799 × 290	716 × 820 × 315	
	Indoor	kg			12.5	12.5	
Weight	Outdoor	kg			36	42	
	Connection Pipe Diameter (Liquid/Gas)				6.35/12.70	6.35/12.70	
Drain Hose Diameter (I.D./O.D.)				13.8/15.8 to 16.7	13.8/15.8 to 16.7		
Max. Pipe Length (Pre-Charge)				25 (15)	30 (15)		
Max. Height Difference				20	25		
Operating Range	Cooling			-10 to 46	-10 to 46		
	Heating			-15 to 24	-15 to 24		
Refrigerant	Type (Global Warming Potential)				R32 (675)	R32 (675)	
	Charge	kg (CO2eq-T)			1.02 (0.689)	1.32 (0.891)	

Optional parts

* For optional parts compatibility of Intesis devices, refer to the optional parts compatibility list Page C-048.

Compact wired remote controller:	UTY-RCRGZ1	Communication kit:	UTY-TWRXZ2	Network Converter for single split (DC power supply type):	UTY-VTGX
Wired remote controller (touch panel):	UTY-RNRGZ5	External input and output PCB*1:	UTY-XCSXZ2	Network Converter for single split (AC power supply type):	UTY-VTGXV
Wired remote controller:	UTY-RLRG	WLAN adapter:	UTY-TFSXF2	Silver Ion filter:	UTR-FA16-5
Simple remote controller (without operation mode):	UTY-RHRG		UTY-TFSXH3	External switch controller:	UTY-TERX
Simple remote controller:	UTY-RSRG		FG-AC-WIF1Z1	External connect kit:	UTY-XWZXZ5

*1 It is required when 2 or more external input and output ports are used.

Dimensions

(Unit: mm)

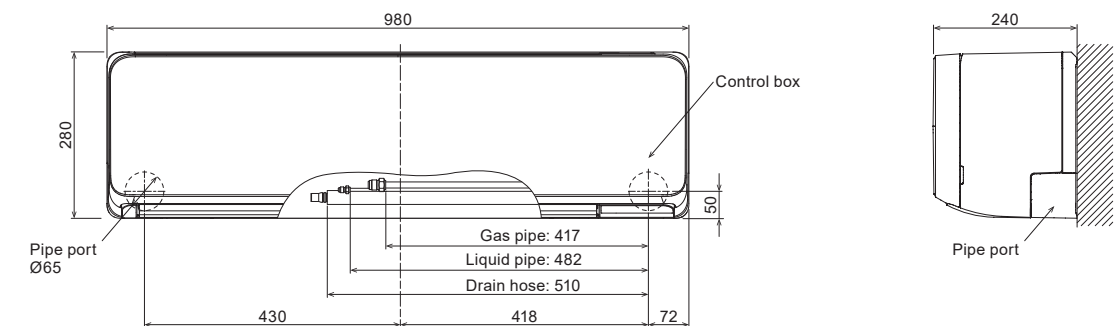

Wall-mounted type

Standard Series

High-Efficiency & Large Rooms



Special Cooling

When it is necessary to be constantly cooled such as rooms with a high heat load, it is possible to operate the cooling with keeping performance even when the outside temperature is low.

- *Wired remote controller (UTY-RNRGZ5) is required.
- *Please note that we will not provide compensation for any damages suffered to your appliances or data as a result of using this function.
- *Please use it in low-humidity environments. Condensation and other problems may be caused when used in high-humidity environments.

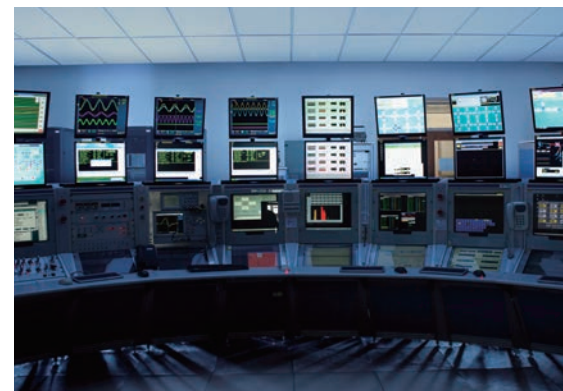

Occupancy sensor

The Occupancy sensor monitors the movements of people in a room and operates the air conditioner at a lower capacity when people leave the room. When people come back to the room, it automatically returns to the previous operating mode.

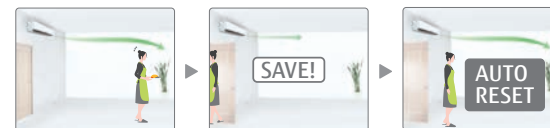

Refrigerant cycle monitor (Option)

Wired Remote Controller (Touch Panel) will support to display some sensor values for maintenance and service support.

- *Wired remote controller (UTY-RNRGZ5) is required.

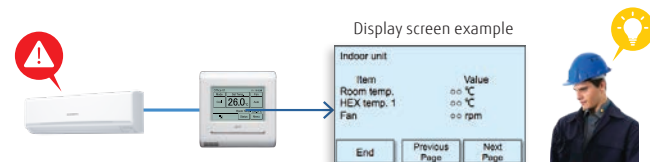

Smart device control (Option)

With the optional WLAN adapter installed in the air conditioner, you can control it from anywhere with your smart device. WLAN adapter can be installed easily without specialized installation work.

- *For more information about smart device control, please refer to the page C-018.



Model: ASHH30KMTB / ASHH36KMTB



Specifications

Model name	Indoor unit		ASHH30KMTB		ASHH36KMTB		
	Outdoor unit		AOHH30KMTB		AOHH36KMTB		
Power Source	Single phase, ~230V, 50Hz						
Capacity	Cooling	kW	8.0 (2.9-9.0)		9.4 (2.9-10.0)		
	Heating	kW	8.8 (2.2-11.8)		10.1 (2.7-12.6)		
Input Power	Cooling/Heating		2.33/2.20		3.16/2.73		
	Cooling	W/W	3.43		2.97		
COP	Heating		4.00		3.70		
	Cooling/Heating (-10°C)	kW	8.0/6.5		9.4/7.1		
SEER	Cooling		6.68		6.10		
	Heating (Average)		4.50		4.50		
Energy Efficiency Class	Cooling		A++		A++		
	Heating (Average)		A+		A+		
Max. Operating Current	Cooling/Heating		21.0/21.0		21.5/21.5		
	Cooling	kWh/a	419		534		
Annual Energy Consumption	Heating		1,994		2,189		
	Moisture Removal		2.6		3.8		
Sound Pressure Level	Indoor (Cooling)	H/M/L/Q	50/44/40/33		50/44/40/33		
	Indoor (Heating)	H/M/L/Q	49/44/39/33		49/44/39/33		
Sound Power Level	Outdoor (Cooling/Heating)	High	53/55		55/55		
	Indoor (Cooling/Heating)	High	65/65		65/65		
	Outdoor (Cooling/Heating)	High	68/69		70/70		
	Indoor/Outdoor (Cooling)	High	1,330/3,750		1,330/3,750		
Airflow Rate	Indoor/Outdoor (Heating)		1,330/3,750		1,330/3,750		
	Indoor	mm	340 × 1,150 × 280		340 × 1,150 × 280		
Net Dimensions H x W x D	Outdoor	mm	788 × 940 × 320		788 × 940 × 320		
	Indoor	kg	18.5		18.5		
Weight	Outdoor	kg	52.0		52.0		
	Connection Pipe Diameter (Liquid/Gas)		9.52/15.88		9.52/15.88		
Drain Hose Diameter (I.D./O.D.)		mm		13.8/15.8 to 16.7		13.8/15.8 to 16.7	
Max. Pipe Length (Pre-Charge)		m		50(30)		50(30)	
Max. Height Difference		m		30		30	
Operating Range	Cooling	°CDB	-15to46		-15to46		
	Heating	°CDB	-15to24		-15to24		
Refrigerant	Type (Global Warming Potential)		R32(675)		R32(675)		
	Charge	kg (CO2eq-T)	1.90(1.283)		1.90(1.283)		

Optional parts

* For optional parts compatibility of Intesis devices, refer to the optional parts compatibility list Page C-048.

- Compact wired remote controller: UTY-RCRGZ1
- Wired remote controller (touch panel): UTY-RNRGZ5
- Wired remote controller: UTY-RLRG
- Simple remote controller (without operation mode): UTY-RHRG
- Simple remote controller: UTY-RSRG
- External connect kit: UTY-XWZXZ5
- External input and output PCB*: UTY-XCSXZ2
- WLAN adapter: UTY-TFSXF2
- UTY-TFSXH3
- FG-AC-WIF1Z1
- Network Converter for single split (DC power supply type): UTY-VTGX
- Network Converter for single split (AC power supply type): UTY-VTGXV
- Silver Ion Filter: UTR-FA13-3
- External switch controller: UTY-TERX
- Communication kit: UTY-TWRXZ2

*1 It is required when 2 or more external input and output ports are used.

Dimensions

(Unit: mm)

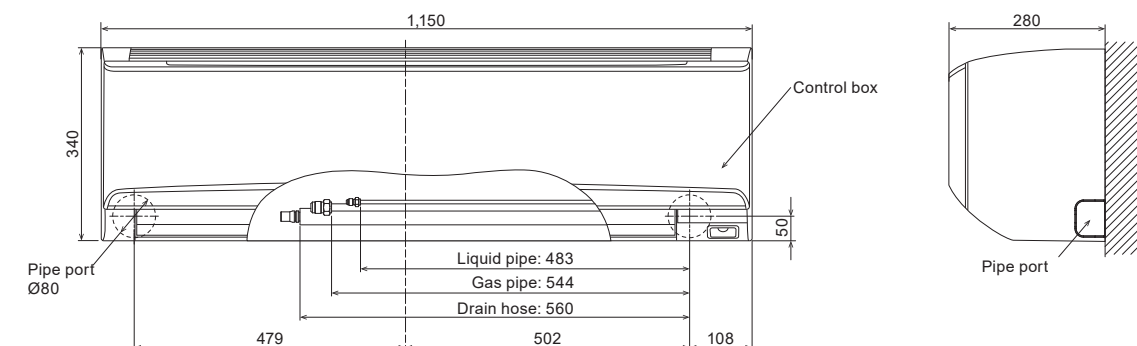

Wall-mounted type
ECO Series
Compact Size



Slim & stylish square design

The slim and stylish square design of this indoor unit is realized by using a high-density, multipath heat exchanger and a high-efficiency wind blower.



High energy saving

High-efficiency has been achieved by the lambda-shaped heat exchanger, large cross-flow fan, and the new refrigerant.



Comfortable airflow & Quiet operation

The large louver and the new air-blowing structure create a comfortable air flow that spreads all the way down to the user's feet with quiet operation.



Smart device control (Option)

With the optional WLAN adapter installed in the air conditioner, you can control it from anywhere with your smart device. WLAN adapter can be installed easily without specialized installation work.

* For more information about smart device control, please refer to the page C-018.

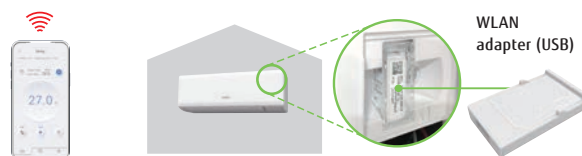

Easy access to the flare pipe connection

Installation when left outlet piping is easier by removable under cover of the indoor unit chassis. Installation when center outlet piping is easier by design change of wall hook bracket.

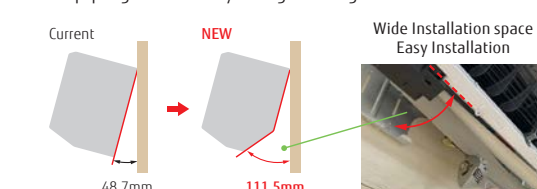

Model: ASHG07KPCE / ASHG09KPCE / ASHG12KPCE



Specifications

Model name	Indoor unit		ASHG07KPCE	ASHG09KPCE	ASHG12KPCE
	Outdoor unit		AOHG07KPCE	AOHG09KPCE	AOHG12KPCE
Power Source	Single phase, ~230 V, 50 Hz				
Capacity	Cooling	kW	2.0 (0.9-2.8)	2.5 (0.9-3.0)	3.4 (0.9-3.7)
	Heating	kW	2.5 (0.9-3.4)	2.8 (0.9-3.8)	3.8 (0.9-4.8)
Input Power	Cooling/Heating		0.48/0.63	0.71/0.79	1.00/1.14
	Cooling	W/W	4.17	3.52	3.40
EER	Cooling		4.17	3.52	3.40
	Heating	W/W	3.97	3.54	3.33
Pdesign	Cooling/Heating (-10°C)		2.0/2.2	2.5/2.4	3.4/2.5
SEER	Cooling		6.70	6.70	6.30
	Heating (Average)		4.00	4.00	4.10
SCOP	Cooling		A++	A++	A++
	Heating (Average)		A+	A+	A+
Max. Operating Current	Cooling/Heating		6.5/9.0	6.5/9.0	6.5/9.0
	Cooling	A	104	131	189
Annual Energy Consumption	Cooling		769	840	853
	Heating		1.0	1.3	1.8
Moisture Removal	Cooling		45/38/31/22	45/38/31/22	46/40/33/22
	Heating		45/40/36/26	45/40/36/26	46/40/35/27
Sound Pressure Level	Indoor (Cooling)	H/M/L/Q	45/46	47/47	49/51
	Indoor (Heating)	H/M/L/Q	57/58	58/58	59/59
Sound Power Level	Outdoor (Cooling/Heating)	High	57/58	59/59	62/62
	Indoor (Cooling/Heating)	High	58/58	59/59	62/62
Airflow Rate	Indoor/Outdoor (Cooling)	High	580/1,650	580/1,650	630/1,700
	Indoor/Outdoor (Heating)	High	580/1,450	580/1,450	630/1,470
Net Dimensions H x W x D	Indoor	mm	270 x 784 x 224	270 x 784 x 224	270 x 784 x 224
	Outdoor	mm	541 x 663 x 290	541 x 663 x 290	541 x 663 x 290
Weight	Indoor	kg	8	8	8
	Outdoor	kg	23	23	25
Connection Pipe Diameter (Liquid/Gas)			6.35/9.52	6.35/9.52	6.35/9.52
Drain Hose Diameter (I.D./O.D.)			11.8/15.0 to 16.8	11.8/15.0 to 16.8	11.8/15.0 to 16.8
Max. Pipe Length (Pre-Charge)			20 (15)	20 (15)	20 (15)
Max. Height Difference			15	15	15
Operating Range	Cooling	°CDB	-10 to 46	-10 to 46	-10 to 46
	Heating	°CDB	-15 to 24	-15 to 24	-15 to 24
Refrigerant	Type (Global Warming Potential)		R32 (675)	R32 (675)	R32 (675)
	Charge	kg (CO2eq-T)	0.55 (0.371)	0.55 (0.371)	0.59 (0.398)

Optional parts

* For optional parts compatibility of Inesis devices, refer to the optional parts compatibility list Page C-048.

- WLAN adapter: UTY-TFSXF2, UTY-TFSXH3
- Silver Ion Filter: UTR-FA16-5

Dimensions

(Unit: mm)

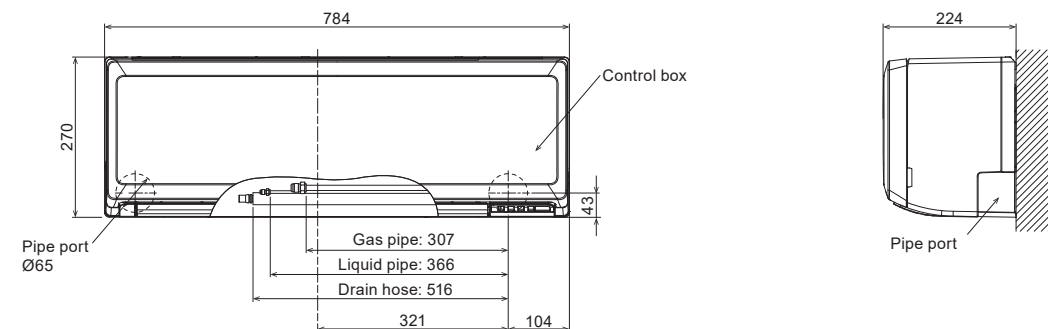

Wall-mounted type

ECO Series

Comfort for Large Rooms



Model: ASHG18KLCA / ASHG24KLCA



Wireless RC



For ASHG18KLCA

For ASHG24KLCA

Specifications

Model name	Indoor unit		Outdoor unit		ASHG18KLCA	ASHG24KLCA
	AOHG18KLCA		AOHG24KLCA			
Power Source	Single phase, ~230 V, 50 Hz					
Capacity	Cooling	kW			5.2 (0.9-5.5)	7.1 (0.9-7.7)
	Heating	kW			6.3 (0.6-7.6)	8.0 (0.9-9.0)
Input Power	Cooling/Heating		kW	1.685/1.80		
	Cooling		W/W	3.09		
COP	Cooling		W/W	3.50		
	Heating		W/W	3.60		
Pdesign	Cooling/Heating (-10°C)		kW	5.20/4.80		
SEER	Cooling		W/W	7.20		
	Heating (Average)		W/W	4.30		
SCOP	Cooling			A++		
	Heating (Average)			A+		
Max. Operating Current	Cooling/Heating		A	9.5/13.5		
	Cooling		kWh/a	253		
Annual Energy Consumption	Heating		kWh/a	1563		
			l/h	1.9		
Moisture Removal	Indoor (Cooling)	H/M/L/Q	47/44/40/35			
	Indoor (Heating)	H/M/L/Q	51/45/38/33			
Sound Pressure Level	Indoor (Cooling/Heating)	High	dB(A)	50/56		
	Indoor (Cooling/Heating)	High	dB(A)	60/65		
Sound Power Level	Indoor (Cooling/Heating)	High	dB(A)	61/66		
	Indoor/Outdoor (Cooling)	High	m³/h	865/1,830		
Airflow Rate	Indoor/Outdoor (Heating)	High	m³/h	995/2,265		
	Indoor	mm	293 × 790 × 249			
Net Dimensions H x W x D	Outdoor	mm	293 × 790 × 249			
	Indoor	kg	9.5			
Weight	Outdoor	kg	33			
	Connection Pipe Diameter (Liquid/Gas)		mm	6.35/9.52		
Drain Hose Diameter (I.D./O.D.)		mm	13.8/15.8 to 16.7			
Max. Pipe Length (Pre-Charge)		m	25 (15)			
Max. Height Difference		m	20			
Operating Range	Cooling	°CDB	-10 to 46			
	Heating	°CDB	-15 to 24			
Refrigerant	Type (Global Warming Potential)		R32 (675)			
	Charge	kg (CO2eq-T)	0.85 (0.574)			

Narrow width & Compact design

Compact and versatile. Powerful airflow is realized despite the 790-mm width compact design for small spaces such as bedrooms or home offices.



Economy operation

Set temperature automatically increases or decreases by 1°C. The thermostat setting is adjusted automatically according to the room temperature to avoid unnecessary cooling or heating.

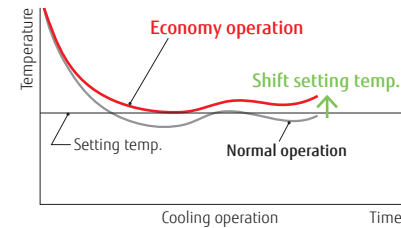

Powerful operation

In powerful operation mode, the compressor operates at maximum speed for 20 minutes to provide a powerful airflow. Rapid cooling and heating makes the room comfortable quickly.

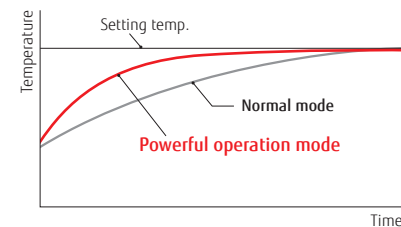

ON-OFF programmable timer

You can set ON/OFF or OFF/ON times depending on your lifestyle needs. (Setting time: 0.5, 1, 1.5, 2, 2.5, -----9.5, 10, 11, 12 hours)

Low ambient operation

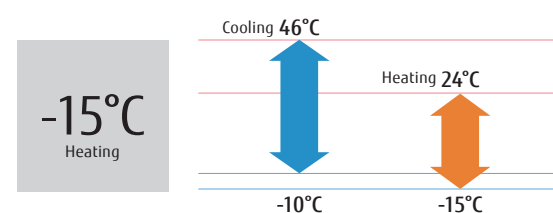

Optional parts

* For optional parts compatibility of Intesis devices, refer to the optional parts compatibility list Page C-046.

Silver Ion Filter: UTR-FA16-5

Dimensions

(Unit: mm)

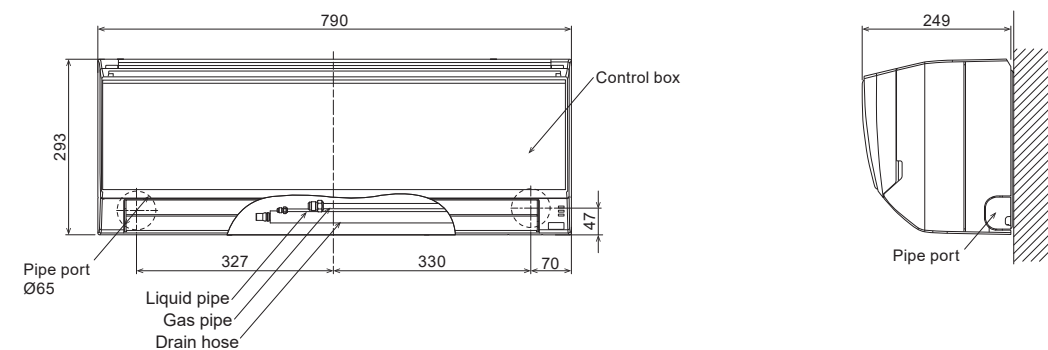

Compact Cassette

Compact 4-way Flow Series

Compact Size



Model: AUXG09KVLA / AUXG12KVLA / AUXG14KVLA / AUXG18KVLA / AUXG22KVLA / AUXG24KVLA



Specifications

Model name	Indoor unit		AUXG09KVLA	AUXG12KVLA	AUXG14KVLA	AUXG18KVLA	AUXG22KVLA	AUXG24KVLA	
	Outdoor unit		AOHG09KBTB	AOHG12KBTB	AOHG14KBTB	AOHG18KBTB	AOHG22KBTB	AOHG24KBTB	
Power Source			Single phase, ~230 V, 50 Hz						
Capacity	Cooling	kW	2.5 (0.9-3.2)	3.5 (0.9-4.4)	4.3 (0.9-5.4)	5.2 (0.9-5.9)	6.0 (0.9-6.7)	6.8 (0.9-8.0)	
	Heating		3.2 (0.9-4.7)	4.1 (0.9-5.7)	5.0 (0.9-6.5)	6.0 (0.9-7.5)	7.0 (0.9-8.0)	7.5 (0.9-9.1)	
Input Power	Cooling/Heating	kW	0.55/0.79	0.93/1.08	1.28/1.32	1.60/1.66	1.82/1.87	2.21/2.03	
EER	Cooling	W/W	4.57	3.76	3.36	3.25	3.30	3.08	
COP	Heating		4.05	3.80	3.79	3.61	3.74	3.69	
Pdesign	Cooling/Heating (-10°C)	kW	2.5/2.6	3.5/3.4	4.3/3.8	5.2/4.4	6.0/4.8	6.8/6.0	
SEER	Cooling	W/W	6.70	6.60	6.50	6.60	6.60	6.10	
SCOP	Heating (Average)		4.40	4.30	4.40	4.20	4.30	4.00	
Energy Efficiency Class	Cooling		A++	A++	A++	A++	A++	A++	
	Heating (Average)		A+	A+	A+	A+	A+	A+	
Max. Operating Current	Cooling/Heating	A	7.9/7.9	9.7/9.7	10.2/10.2	12.1/12.1	12.6/12.6	13.6/13.6	
	Cooling		kWh/a	131	186	231	275	318	390
Annual Energy Consumption	Heating		826	1,106	1,208	1,466	1,562	2,097	
	Moisture Removal		l/h	0.6	1.2	1.5	2.2	2.6	2.7
Sound Pressure Level	Indoor (Cooling)	H/M/L/Q	33/31/29/27						
	Indoor (Heating)		H/M/L/Q	34/32/29/27					
Sound Power Level	Outdoor (Cooling/Heating)	High	46/46						
	Indoor (Cooling/Heating)		High	46/47					
Airflow Rate	Indoor/Outdoor (Cooling)	High	540/1,480						
	Indoor/Outdoor (Heating)		High	540/1,410					
Net Dimensions H x W x D	Indoor	mm	245 x 570 x 570						
	Outdoor		mm	542 x 799 x 290					
Weight	Indoor	kg	15						
	Outdoor		kg	32					
Connection Pipe Diameter (Liquid/Gas)			6.35/9.52						
Drain Hose Diameter (I.D./O.D.)			25/32						
Max. Pipe Length (Pre-Charge)			20 (15)						
Max. Height Difference			15						
Operating Range	Cooling	°CDB	-15 to 46						
	Heating		°CDB	-15 to 24					
Refrigerant	Type (Global Warming Potential)			R32 (675)					
	Charge	kg (CO2eq-T)			0.85 (0.574)				
Cassette Grille	Model name			UTG-UFGF-W					
	Dimensions (H x W x D)			49 x 620 x 620					
	Weight			2.3					

Compact and stylish panel design

The compact and stylish panel fits nicely into a grid-type ceiling. Its linear design is a perfect fit into a grid of 620 mm x 620 mm in the ceiling.



Easy maintenance

You can access the unit for maintenance simply by removing a ceiling panel next to the grille. As no inspection hole needs to be cut through the ceiling, no additional construction cost is incurred.

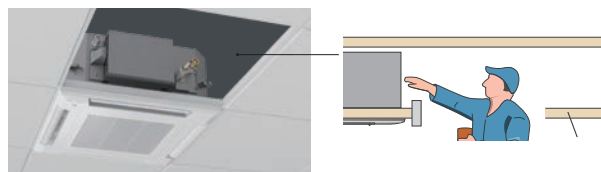

The air inlet grille can be installed to open in any direction for easy maintenance.



Flexible installation

The unit fits nicely into the decor of a grid-type ceiling and can be installed near the lighting or a ventilation opening.



Link up with a variety of central control system (Option)

Centralized control including facilities and equipment in addition to air conditioning is possible by linking up with MODBUS, KNX interfaces.



Optional parts

* For optional parts compatibility of Intesis devices, refer to the optional parts compatibility list Page C-048.

Compact wired remote controller: UTY-RCRGZ1	External switch controller: UTY-TERX	Network Converter for single split (DC power supply type): UTY-VTGX
Wired remote controller (touch panel): UTY-RNRGZ5	WLAN adapter: UTY-TFSXZ1	Network Converter for single split (AC power supply type): UTY-VTGXV
Wired remote controller: UTY-RLRG	FG-RC-WIF1Z2	Insulation kit for high humidity: UTZ-KXGC
UTY-RNNGM	UTY-TFSXJ3	External input and output PCB: UTY-XCSX
UTY-RVNGM	FG-AC-WIF1Z1	External input and output PCB box: UTZ-CXRA
Simple remote controller (without operation mode): UTY-RHRG	Air Outlet Shutter Plate: UTR-YDZB	Silver Ion Filter: UTD-HFAA
Simple remote controller: UTY-RSRG	External connect kit: UTY-XWZKZG	
UTY-RSNGM	Cassette Grille: UTG-UFGF-W	
UTY-LNTG	Fresh air intake kit: UTZ-VXAA	

Dimensions

(Unit: mm)

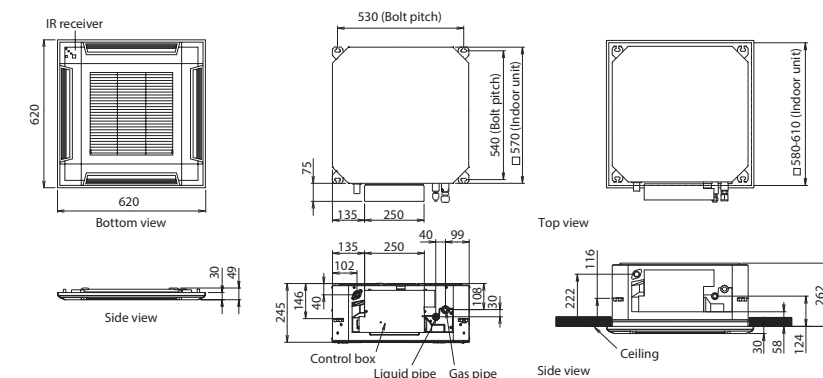

Cassette

Circular Flow Series

Comfort for Large Rooms



Unique circular flow design

The Cassette model realizes a Circular Flow to blow a large airflow in a 360° direction by using a high-performance DC fan motor, turbo fan, and a unique seamless airflow louver design.



Airflows avoid blowing cool air directly at the occupants in the room, providing more comfortable air conditioning. Provides efficient air conditioning based on the room layout.

Individual louver control

Each louver can be controlled individually with a wired remote controller equipped with a touch panel to provide different directional airflows according to the room layout.

*Wired remote controller (touch panel) (UTY-RNRGZ3) only

The Occupancy sensor yields more energy savings. Energy saving operation starts automatically by detecting the motion of a person. Two modes of save operation mode and stop mode can be selected.

Compact and lightweight outdoor unit

The outdoor units for the 45,000 BTU and 54,000 BTU models have been completely redesigned. Easier installation is achieved for this compact and lightweight outdoor unit.

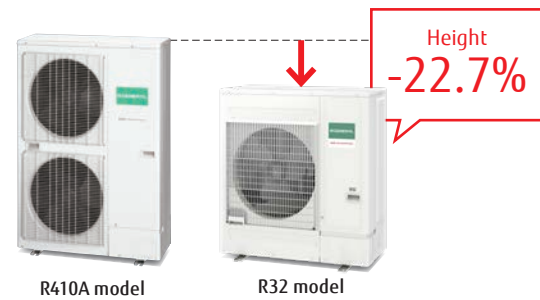

Various cassette grilles

Both black and white grilles are available. Three types of grilles are available: a white grille with a remote controller; a white grille without a remote controller; and a black grille without a remote controller. Select to match the atmosphere and/or usage of the room.



Model: AUXG18KRLB / AUXG22KRLB / AUXG24KRLB / AUXG30KRLB / AUXG36KRLB / AUXG45KRLB / AUXG54KRLB
 AUXG36KRLB [3-phase] / AUXG45KRLB [3-phase] / AUXG54KRLB [3-phase]



Specifications

Model name	Indoor unit		AUXG18KRLB	AUXG22KRLB	AUXG24KRLB	AUXG30KRLB	AUXG36KRLB	AUXG45KRLB	AUXG54KRLB	AUXG36KRLB	AUXG45KRLB	AUXG54KRLB
	Outdoor unit		AOHG18KBTB	AOHG22KBTB	AOHG24KBTB	AOHG30KBTB	AOHG36KBTB	AOHG45KBTB	AOHG54KBTB	AOHG36KRTA	AOHG45KRTA	AOHG54KRTA
Power Source			Single phase, ~230 V, 50 Hz						3-phase, ~400 V, 50 Hz			
Capacity	Cooling	kW	5.2 (0.9-5.9)	6.0 (0.9-6.7)	6.8 (0.9-8.0)	8.5 (2.8-10.0)	9.5 (2.8-11.2)	12.1 (4.0-14.0)	13.4 (4.5-14.5)	9.5 (2.8-11.2)	12.1 (4.0-14.0)	13.4 (4.5-14.5)
	Heating		6.0 (0.9-7.5)	7.0 (0.9-8.0)	7.5 (0.9-9.1)	10.0 (2.7-11.2)	10.8 (2.7-12.7)	13.5 (4.2-16.2)	15.5 (4.7-16.5)	10.8 (2.7-12.7)	13.5 (4.2-16.2)	15.5 (4.7-16.5)
Input Power	Cooling/Heating	kW	1.36/1.58	1.71/1.82	1.89/1.90	2.44/2.51	2.91/2.45	3.61/3.21	4.41/4.16	2.91/2.45	3.61/3.21	4.41/4.16
	Cooling		3.82	3.51	3.60	3.49	3.26	3.35	3.04	3.26	3.35	3.04
EER	Cooling	W/W	3.80	3.85	3.95	3.98	4.40	4.20	3.73	4.40	4.20	3.73
	Heating		3.80	3.85	3.95	3.98	4.40	4.20	3.73	4.40	4.20	3.73
Pdesign	Cooling/Heating (-10°C)	kW	5.2/4.4	6.0/4.8	6.8/6.0	8.5/8.0	9.5/8.7	-	-	9.5/8.7	-	-
	Cooling		7.00	7.00	6.60	6.70	6.55	-	-	6.55	-	-
SEER	Cooling	W/W	4.30	4.40	4.20	4.30	4.30	-	-	4.30	-	-
	Heating (Average)		4.30	4.40	4.20	4.30	4.30	-	-	4.30	-	-
Energy Efficiency Class	Cooling		A++	A+	A+	A+	A+	-	-	A+	-	-
	Heating (Average)		A+	A+	A+	A+	A+	-	-	A+	-	-
Max. Operating Current	Cooling/Heating	A	12.1/12.1	12.6/12.6	13.6/13.6	22.6/22.6	22.6/22.6	28.5/28.5	28.5/28.5	10.5/10.5	14.0/14.0	14.0/14.0
	Cooling		260	300	360	444	507	-	-	507	-	-
Annual Energy Consumption	Cooling	kWh/a	1,431	1,527	1,999	2,601	2,828	-	-	2,828	-	-
	Heating		1.5	2.2	2.7	2.5	3.3	4.5	5.0	3.3	4.5	5.0
Moisture Removal	Indoor (Cooling)	l/h	33/32/31/28	33/32/31/28	35/33/32/29	40/38/36/33	44/41/38/34	46/42/39/35	47/43/40/36	44/41/38/34	46/42/39/35	47/43/40/36
	Indoor (Heating)		33/32/31/28	33/32/31/28	35/33/32/29	40/38/36/33	44/41/38/34	46/42/39/35	47/43/40/36	44/41/38/34	46/42/39/35	47/43/40/36
Sound Pressure Level	Indoor (Cooling/Heating)	dB(A)	50/50	51/51	53/54	53/55	55/55	57/57	57/59	55/55	57/57	57/59
	Outdoor (Cooling/Heating)		47/47	49/49	49/49	54/54	58/58	60/60	61/61	58/58	60/60	61/61
Sound Power Level	Indoor (Cooling/Heating)	High	62/62	63/63	65/66	68/69	70/70	71/71	73/73	70/70	71/71	73/73
	Outdoor (Cooling/Heating)		62/62	63/63	65/66	68/69	70/70	71/71	73/73	70/70	71/71	73/73
Airflow Rate	Indoor/Outdoor (Cooling)	m³/h	1,050/2,160	1,050/2,240	1,150/2,700	1,600/3,750	1,870/3,750	2,000/4,450	2,100/4,450	1,870/3,750	2,000/4,450	2,100/4,450
	Indoor/Outdoor (Heating)		1,050/1,830	1,050/1,960	1,150/2,700	1,600/3,750	1,870/3,750	2,000/4,450	2,100/4,450	1,870/3,750	2,000/4,450	2,100/4,450
Net Dimensions H x W x D	Indoor	mm	246 × 840 × 840	246 × 840 × 840	246 × 840 × 840	288 × 840 × 840	288 × 840 × 840	288 × 840 × 840	288 × 840 × 840	288 × 840 × 840	288 × 840 × 840	288 × 840 × 840
	Outdoor		632 × 799 × 290	632 × 799 × 290	716 × 820 × 315	788 × 940 × 320	788 × 940 × 320	998 × 940 × 320	998 × 940 × 320	788 × 940 × 320	998 × 940 × 320	998 × 940 × 320
Weight	Indoor	kg	23	23	24	26	29	29	29	29	29	29
	Outdoor		36	38	42	52	52	67	67	53	67	67
Connection Pipe Diameter (Liquid/Gas)	Indoor	mm	6.35/12.70	6.35/12.70	6.35/12.70	9.52/15.88	9.52/15.88	9.52/15.88	9.52/15.88	9.52/15.88	9.52/15.88	9.52/15.88
	Outdoor		25/32	25/32	25/32	25/32	25/32	25/32	25/32	25/32	25/32	25/32
Drain Hose Diameter (I.D./O.D.)	Indoor	mm	30 (20)	30 (20)	30 (20)	50 (30)	50 (30)	50 (30)	50 (30)	50 (30)	50 (30)	50 (30)
	Outdoor		20	25	25	30	30	30	30	30	30	30
Max. Pipe Length (Pre-Charge)	Indoor	m	30	30	30	50	50	50	50	30	30	30
	Outdoor		30	30	30	50	50	50	50	30	30	30
Max. Height Difference	Indoor	m	30	30	30	50	50	50	50	30	30	30
	Outdoor		30	30	30	50	50	50	50	30	30	30
Operating Range	Cooling	°CDB	-15 to 46	-15 to 46	-15 to 46	-15 to 46	-15 to 46	-15 to 46	-15 to 46	-15 to 46	-15 to 46	-15 to 46
	Heating		-15 to 24	-15 to 24	-15 to 24	-15 to 24	-15 to 24	-15 to 24	-15 to 24	-15 to 24	-15 to 24	-15 to 24
Refrigerant	Type (Global Warming Potential)	kg (CO2eq-T)	R32 (675)	R32 (675)	R32 (675)	R32 (675)	R32 (675)	R32 (675)	R32 (675)	R32 (675)	R32 (675)	R32 (675)
	Charge		1.02 (0.689)	1.25 (0.844)	1.25 (0.844)	1.90 (1.283)	1.90 (1.283)	2.70 (1.823)	2.70 (1.823)	1.90 (1.283)	2.70 (1.823)	2.70 (1.823)
Cassette Grille	Variation	UTG-UKGA-W: White wired remote controller (touch panel) UTG-UKGC-W: White/UTG-UKGA-B*1: Black						UTG-UKGA-W: White wired remote controller (touch panel) UTG-UKGC-W: White/UTG-UKGA-B*1: Black				
	Dimensions (H × W × D)	mm	53 × 950 × 950	53 × 950 × 950	53 × 950 × 950	53 × 950 × 950	53 × 950 × 950	53 × 950 × 950	53 × 950 × 950	53 × 950 × 950	53 × 950 × 950	53 × 950 × 950
	Weight	kg	6.0	6.0	6.0	6.0	6.0	6.0	6.0	6.0	6.0	6.0

*1: IR Receiver kit and Occupancy sensor kit cannot be connected.

Optional parts

* For optional parts compatibility of Intesis devices, refer to the optional parts compatibility list Page C-048.

Compact wired remote controller: Wired remote controller (touch panel): Wired remote controller:	UTY-RCRGZ1 UTY-RNRGZ5 UTY-RLRG UTY-RNNGM UTY-RVNGM UTY-RHRG UTY-RSRG UTY-RSNGM UTY-SHZXC UTY-TERX UTY-LBTGC	WLAN adapter: External input and output PCB: External input and output PCB box: Insulation kit for high humidity: Fresh air intake kit: Wide Panel: Panel Spacer: External connect kit:	UTY-TFSXZ1 FG-RC-WIF1Z2 UTY-TFSXJ3 FG-AC-WIF1Z1 UTY-XCSX UTZ-GXRA UTZ-KXRA UTZ-VXRA UTG-AKXA-W UTG-BKXA-W UTY-XWZXZG	Cassette Grille: Air Outlet Shutter Plate: Network Converter for single split (DC power supply type): Network Converter for single split (AC power supply type): Silver Ion Filter: (Outdoor unit 30/36/45/54) External connect kit:	UTG-UKGA-B UTG-UKGA-W UTG-UKGC-W UTR-YDZK UTY-VTGX UTY-VTGVX UTD-HFRA UTY-XWZXZ3
--	---	--	--	--	---

Dimensions

(Unit: mm)

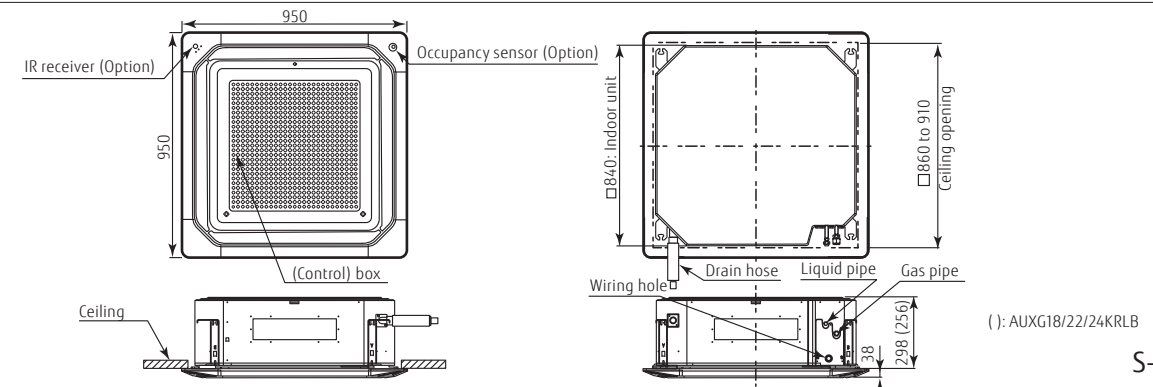

(): AUXG18/22/24KRLB

Slim Duct

Slim Design



Slim design

The slim design fits nicely into narrow spaces under the ceiling. Drain hose as standard accessory



Compact and lightweight outdoor unit

The compact and lightweight outdoor unit offers greater flexibility in the choice of installation location. This makes it easier to use this outdoor unit.

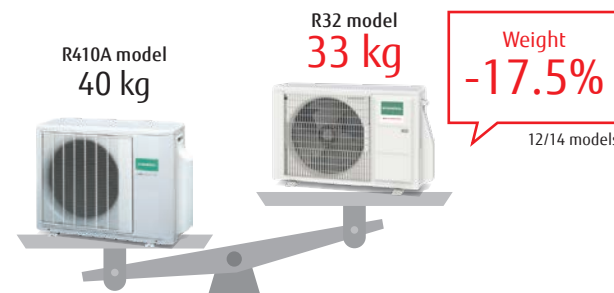

Wide range of static pressures

The use of a DC fan motor makes it possible to adjust the static pressure between 0 and 90 Pa. The static pressure range can be changed by a remote controller.



Static pressure range
0 to 90 Pa

Auto louver grille kit (Option)

The optional clean-looking flat Auto louver blends into any interior and provides a comfortable airflow.



Link up with a variety of central control system (Option)

Centralized control including facilities and equipment in addition to air conditioning is possible by linking up with MODBUS, KNX interfaces.



Central Control System

Model: ARXG09KLLAP / ARXG12KLLAP / ARXG14KLLAP / ARXG18KLLAP

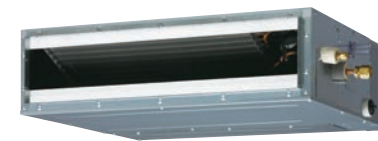

ARXG09/12/14KLLAP

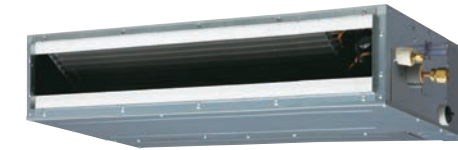

ARXG18KLLAP



For ARXG09/12/14KLLAP For ARXG18KLLAP

Specifications

Model name	Indoor unit		ARXG09KLLAP	ARXG12KLLAP	ARXG14KLLAP	ARXG18KLLAP
	Outdoor unit		AOHG09KBTB	AOHG12KBTB	AOHG14KBTB	AOHG18KBTB
Power Source	Single phase, ~230 V, 50 Hz					
Capacity	Cooling	kW	2.5 (0.9-3.2)	3.5 (0.9-4.4)	4.3 (0.9-5.4)	5.2 (0.9-5.9)
	Heating		3.2 (0.9-4.7)	4.1 (0.9-5.7)	5.0 (0.9-6.5)	6.0 (0.9-7.5)
Input Power	Cooling/Heating	kW	0.60/0.79	0.93/1.08	1.28/1.32	1.55/1.62
	Cooling		4.17	3.76	3.36	3.35
EER	Cooling	W/W	4.05	3.80	3.79	3.70
	Heating		4.05	3.80	3.79	3.70
COP	Cooling/Heating (-10°C)	kW	2.5/2.6	3.5/3.4	4.3/3.8	5.2/4.4
	Cooling		6.20	6.10	5.80	6.20
SEER	Cooling	W/W	4.30	4.00	3.90	4.10
	Heating		4.30	4.00	3.90	4.10
SCOP	Cooling	W/W	A++	A++	A+	A++
	Heating		A+	A+	A	A+
Energy Efficiency Class	Cooling/Heating	A	7.9/7.9	9.7/9.7	10.2/10.2	12.1/12.1
	Cooling		141	201	259	293
Max. Operating Current	Cooling/Heating	kWh/a	845	1,189	1,362	1,501
	Heating		0.7	1.3	1.5	2.0
Annual Energy Consumption	Cooling	l/h	28/27/26/25	29/28/26/25	32/30/28/26	32/30/29/27
	Heating		28/26/25/24	29/28/26/24	32/30/28/25	32/30/29/27
Moisture Removal	Indoor (Cooling)	dB(A)	46/46	47/47	49/49	50/50
	Indoor (Heating)		57/57	58/58	60/60	58/58
Sound Pressure Level	Outdoor (Cooling/Heating)	High	59/59	61/61	62/62	62/62
	Indoor (Cooling/Heating)		600/1,480	650/1,580	800/1,670	940/2,160
Sound Power Level	Indoor/Outdoor (Cooling)	m³/h	600/1,410	650/1,520	800/1,580	940/1,830
	Indoor/Outdoor (Heating)		0 to 90 (25)	0 to 90 (25)	0 to 90 (25)	0 to 90 (25)
Airflow Rate	Static pressure range (Standard)	Pa	198 × 700 × 620	198 × 700 × 620	198 × 700 × 620	198 × 900 × 620
	Indoor		542 × 799 × 290	542 × 799 × 290	542 × 799 × 290	632 × 799 × 290
Static pressure range (Standard)	Indoor	mm	17	17	17	20
	Outdoor		32	33	33	36
Net Dimensions H x W x D	Indoor	kg	6.35/9.52	6.35/9.52	6.35/9.52	6.35/12.70
	Outdoor		25/32	25/32	25/32	25/32
Weight	Indoor	m	20 (15)	25 (15)	25 (15)	30 (20)
	Outdoor		15	20	20	20
Connection Pipe Diameter (Liquid/Gas)	Cooling	°CDB	-15 to 46	-15 to 46	-15 to 46	-15 to 46
	Heating		-15 to 24	-15 to 24	-15 to 24	-15 to 24
Operating Range	Type (Global Warming Potential)	kg (CO2eq-T)	R32 (675)	R32 (675)	R32 (675)	R32 (675)
	Charge		0.85 (0.574)	0.85 (0.574)	0.85 (0.574)	1.02 (0.689)

Optional parts

* For optional parts compatibility of Inesis devices, refer to the optional parts compatibility list Page C-048.

Compact wired remote controller:	UTY-RCRGZ1	WLAN adapter:	UTY-TFSXZ1	Network Converter for single split (DC power supply type):	UTY-VTGX
Wired remote controller (touch panel):	UTY-RNRGZ5		FG-RC-WIF12Z	Network Converter for single split (AC power supply type):	UTY-VTGXV
Wired remote controller:	UTY-RLRG		UTY-TFSXJ3	External connect kit:	UTY-XWZXZG
	UTY-RNNGM		FG-AC-WIF1Z1	Remote sensor unit:	UTY-XSZXZ1
	UTY-RVNGM	Silver Ion Filter:	UTD-HFTA (09-14)	IR receiver unit:	UTY-LBTGM
	UTY-RHRG		UTD-HFTB (18)	External switch controller:	UTY-TERX
Simple remote controller (without operation mode):	UTY-RSRG	Auto Louver Grille Kit:	UTD-GXTA-W (09-14)		
Simple remote controller:	UTY-RSNGM		UTD-GXTB-W (18)		

Dimensions

(Unit: mm)

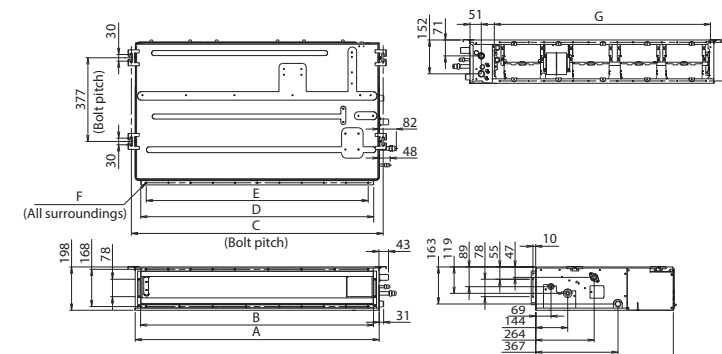

	ARXG09/12/14KLLAP	ARXG18KLLAP
A	700	900
B	650	850
C	734	934
D	650	850
E	P100 × 6 = 600	P100 × 8 = 800
F	18 × Ø5	22 × Ø5
G	574	774

Medium Static Pressure Duct

High-Efficiency & Comfort



Slim & Compact design

The new product has reduced the height to 240 mm, making it more compact. The slim design fits nicely into narrow spaces under the ceiling.

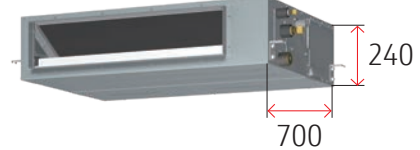

(Unit: mm)

High energy saving

The new model has achieved high energy efficiency rank with a compact design.

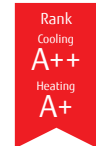

SEER **6.50**^{*1}

SCOP **4.20**^{*2}

*1: 22 model

*2: 22/24 models

Easy maintenance

The indoor units have large panels on both sides providing easy maintenance in narrow spaces.

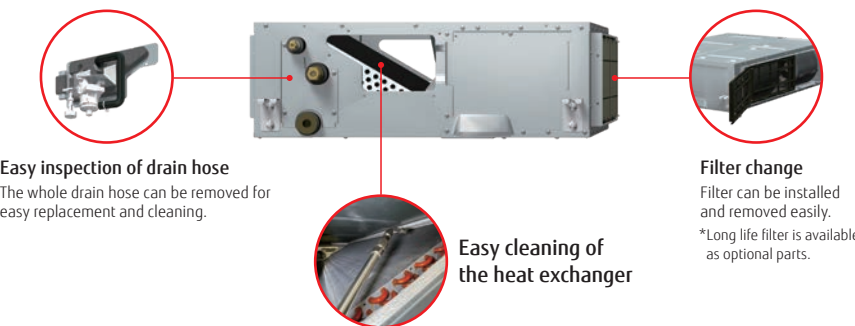

Easy inspection of drain hose
The whole drain hose can be removed for easy replacement and cleaning.

Filter change
Filter can be installed and removed easily.
*Long life filter is available as optional parts.

Easy cleaning of the heat exchanger

Drain hose as standard

A drain hose is a standard accessory, making it easy to design drainage even in narrow spaces under the ceiling.



Wide range of static pressures

Static pressures can be changed in the range of 30 to 150 Pa.

Static pressure range **30 to 150 Pa**

Model: ARXH22KMTAP / ARXH24KMTAP / ARXH30KMTAP / ARXH36KMTAP / ARXH45KMTAP / ARXH54KMTAP
ARXH36KMTAP [3-phase] / ARXH45KMTAP [3-phase] / ARXH54KMTAP [3-phase]

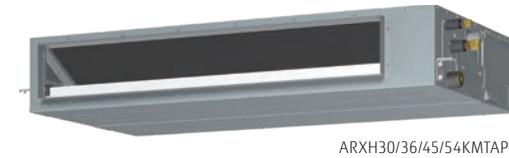
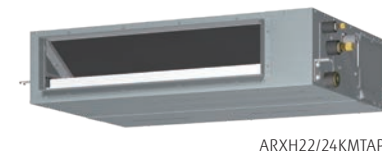

Specifications

Model name	Indoor unit					Outdoor unit				
	ARXH22KMTAP	ARXH24KMTAP	ARXH30KMTAP	ARXH36KMTAP	ARXH45KMTAP	AOHG36KRTA	AOHG45KRTA	AOHG54KRTA		
Power Source	Single phase, ~230 V, 50 Hz					3-phase, ~400 V, 50 Hz				
Capacity	Cooling	6.0 (0.9-6.7)	6.8 (0.9-8.0)	8.5 (2.8-10.0)	9.5 (2.8-11.2)	12.1 (4.0-13.5)	9.5 (2.8-11.2)	12.1 (4.0-13.5)	13.4 (4.5-14.5)	
	Heating	7.0 (0.9-8.0)	7.5 (0.9-9.1)	10.0 (2.7-11.2)	10.8 (2.7-12.7)	13.5 (4.2-16.2)	10.8 (2.7-12.7)	13.5 (4.2-16.2)	15.5 (4.7-16.5)	
Input Power	Cooling/Heating	1.67 / 1.84	1.89 / 1.87	2.57 / 2.50	2.97 / 2.70	3.87 / 3.73	2.97 / 2.70	3.87 / 3.73	4.62 / 4.65	
EER	Cooling	3.60	3.60	3.31	3.20	3.13	3.20	3.13	2.90	
	Heating	3.80	4.01	4.00	4.00	3.62	4.00	3.62	3.33	
Pdesign	Cooling/Heating (-10°C)	6.0 / 4.8	6.8 / 6.0	8.5 / 8.0	9.5 / 8.7	-	9.5 / 8.7	-	-	
SEER	Cooling	6.50	6.40	6.23	6.10	-	6.10	-	-	
	Heating (Average)	4.20	4.20	4.00	4.10	-	4.10	-	-	
Energy Efficiency Class	Cooling	A++	A++	A++	A++	-	A++	-	-	
	Heating (Average)	A+	A+	A+	A+	-	A+	-	-	
Max. Operating Current	Cooling/Heating	12.6 / 12.6	13.6 / 13.6	22.6 / 22.6	22.6 / 22.6	28.5 / 28.5	10.5 / 10.5	14.0 / 14.0	14.0 / 14.0	
Annual Energy Consumption	Cooling	331	380	485	553	-	553	-	-	
	Heating	1,598	1,999	2,795	2,970	-	2,970	-	-	
Moisture Removal		1.5	2.2	1.8	2.0	4.0	2.0	4.0	5.0	
Sound Pressure Level	Indoor (Cooling)	H/M/L/Q	32 / 28 / 25 / 24	34 / 30 / 28 / 26	38 / 34 / 31 / 28	38 / 34 / 31 / 28	40 / 36 / 32 / 29	38 / 34 / 31 / 28	40 / 36 / 32 / 29	40 / 36 / 32 / 29
	Indoor (Heating)	H/M/L/Q	32 / 28 / 25 / 24	34 / 30 / 28 / 26	38 / 34 / 31 / 28	38 / 34 / 31 / 28	40 / 36 / 32 / 29	38 / 34 / 31 / 28	40 / 36 / 32 / 29	40 / 36 / 32 / 29
Sound Power Level	Outdoor (Cooling/Heating)	High	51 / 51	53 / 54	53 / 55	55 / 55	57 / 57	55 / 55	57 / 57	57 / 59
	Indoor (Cooling/Heating)	High	58 / 58	60 / 60	64 / 64	65 / 65	67 / 67	65 / 65	67 / 67	67 / 67
Airflow Rate	Indoor/Outdoor (Cooling)	High	1,150 / 2,240	1,230 / 2,700	1,950 / 3,750	2,070 / 3,750	2,160 / 4,450	2,070 / 3,750	2,160 / 4,450	2,160 / 4,450
	Indoor/Outdoor (Heating)	High	1,150 / 1,960	1,230 / 2,700	1,950 / 3,750	2,070 / 3,750	2,160 / 4,450	2,070 / 3,750	2,160 / 4,450	2,160 / 4,450
Static pressure range (Standard)		Pa	30 to 150 (40)	30 to 150 (50)	30 to 150 (50)	30 to 150 (50)	30 to 150 (60)	30 to 150 (50)	30 to 150 (60)	30 to 150 (60)
Net Dimensions	Indoor	mm	240 × 1,000 × 700	240 × 1,000 × 700	240 × 1,400 × 700	240 × 1,400 × 700	240 × 1,400 × 700	240 × 1,400 × 700	240 × 1,400 × 700	240 × 1,400 × 700
H x W x D	Outdoor	mm	632 × 799 × 290	716 × 820 × 315	788 × 940 × 320	788 × 940 × 320	998 × 940 × 320	788 × 940 × 320	998 × 940 × 320	998 × 940 × 320
Weight	Indoor	kg	31	31	42	42	42	42	42	
	Outdoor	kg	38	42	52	52	67	53	67	
Connection Pipe Diameter (Liquid/Gas)		mm	6.35 / 12.70	6.35 / 12.70	9.52 / 15.88	9.52 / 15.88	9.52 / 15.88	9.52 / 15.88	9.52 / 15.88	
Drain Hose Diameter (I.D./O.D.)		mm	25 / 32	25 / 32	25 / 32	25 / 32	25 / 32	25 / 32	25 / 32	
Max. Pipe Length (Pre-Charge)		m	30 (20)	30 (20)	50 (30)	50 (30)	50 (30)	50 (30)	50 (30)	
Max. Height Difference		m	25	25	30	30	30	30	30	
Operating Range	Cooling	°CDB	-15 to 46	-15 to 46	-15 to 46	-15 to 46	-15 to 46	-15 to 46	-15 to 46	
	Heating	°CDB	-15 to 24	-15 to 24	-15 to 24	-15 to 24	-15 to 24	-15 to 24	-15 to 24	
Refrigerant	Type (Global Warming Potential)		R32 (675)	R32 (675)	R32 (675)	R32 (675)	R32 (675)	R32 (675)	R32 (675)	
	Charge	kg (CO ₂ eq-1)	1.25 (0.844)	1.25 (0.844)	1.90 (1.283)	1.90 (1.283)	2.70 (1.823)	1.90 (1.283)	2.70 (1.823)	2.70 (1.823)

Optional parts

Compact wired remote controller:	UTY-RCRGZ1	Silver ion filter:	UTD-HFNB (22/24)	External input and output PCB:	UTY-XCSX
Wired remote controller (touch panel):	UTY-RNRGZ5		UTD-HFNA (30/36/45/54)	External input and output PCB bracket:	UTZ-GXDA
Wired remote controller:	UTY-RLRG	Long-life filter:	UTD-LFDB (22/24)	Network Converter for single split (DC power supply type):	UTY-VTGX
Simple remote controller (without operation mode):	UTY-RHRG		UTD-LFDA (30/36/45/54)	Network Converter for single split (AC power supply type):	UTY-VTGXV
Simple remote controller:	UTY-RSRG	MODBUS converter:	UTY-VMSX	(Outdoor unit 30/36/45/54)	
IR receiver unit:	UTY-LBTGM	KNX converter:	UTY-VKSX	External connect kit:	UTY-XWZX23
Remote sensor unit:	UTY-XSZX	WLAN adapter:	UTY-TFSXZ1		
	UTY-XSZXZ1		UTY-TFSXJ3		
External switch controller:	UTY-TERX	External connect kit:	UTY-XWZXZG		

Dimensions

(Unit: mm)

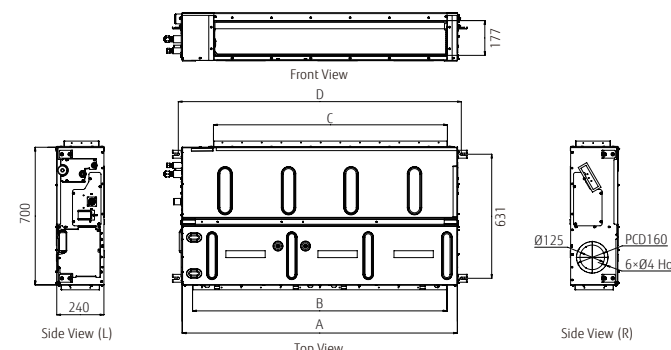

	ARXH22/24KMTAP	ARXH30/36/45/54KMTAP
A	1,000	1,400
B	895	1,295
C	790	1,190
D	1,040	1,440

Medium Static Pressure Duct Compact Size



High-efficiency & Quiet operation

The combination of the V-shaped heat exchanger, air stabilizer, and the high-efficiency DC fan motor enable high-efficiency and quiet operation.

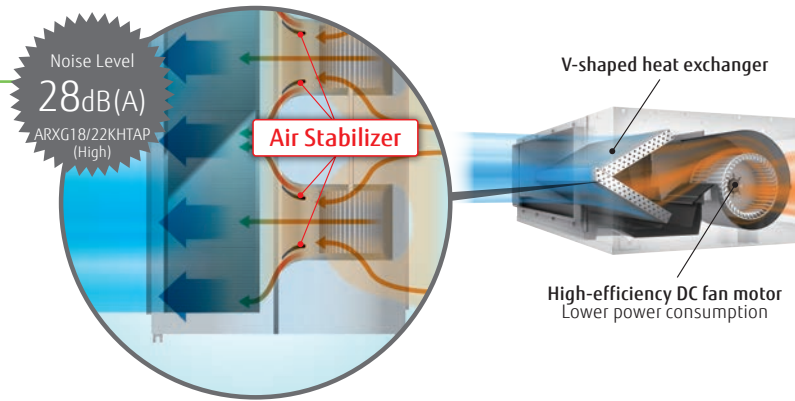

Small, lightweight outdoor unit

The outdoor unit in this series is smaller and lighter than previous-generation outdoor units. It can be installed in a narrow space.

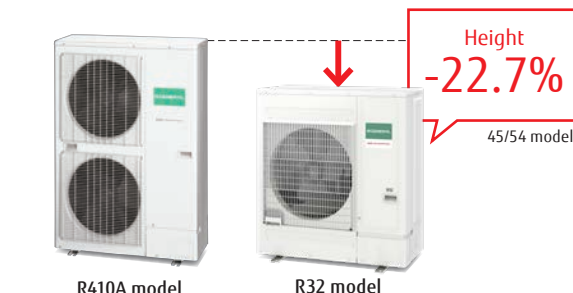
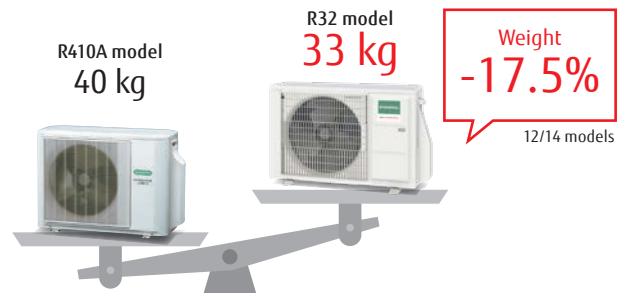

Automatic airflow adjustment function

This unique and innovative function detects required air flow in each application case and automatically adjust the volume.



Link up with a variety of central control system (Option)

Centralized control including facilities and equipment in addition to air conditioning is possible by linking up with MODBUS, KNX interfaces.



Model: ARXG12KHTAP / ARXG14KHTAP / ARXG18KHTAP / ARXG22KHTAP / ARXG24KHTAP / ARXG30KHTAP / ARXG36KHTAP / ARXG45KHTAP / ARXG54KHTAP / ARXG36KHTAP [3-phase] / ARXG45KHTAP [3-phase] / ARXG54KHTAP [3-phase]



Specifications

Model name	Indoor unit		Outdoor unit									
	ARXG12KHTAP	ARXG14KHTAP	ARXG18KHTAP	ARXG22KHTAP	ARXG24KHTAP	ARXG30KHTAP	ARXG36KHTAP	ARXG45KHTAP	ARXG54KHTAP	ARXG36KHTAP	ARXG45KHTAP	ARXG54KHTAP
Power Source	Single phase, ~230 V, 50 Hz										3-phase, ~400 V, 50 Hz	
Capacity	Cooling		kW									
Input Power	Cooling/Heating		kW									
EER	Cooling		W/W									
COP	Heating		W/W									
Pdesign	Cooling/Heating (-10°C)		kW									
SEER	Cooling		W/W									
SCOP	Heating (Average)		W/W									
Energy Efficiency Class	Cooling		A++									
	Heating (Average)		A+									
Max. Operating Current	Cooling/Heating		A									
Annual Energy Consumption	Cooling		kWh/a									
	Heating		kWh/a									
Moisture Removal	Cooling		l/h									
Sound Pressure Level	Indoor (Cooling)		H/M/L/Q									
	Indoor (Heating)		H/M/L/Q									
Sound Power Level	Outdoor (Cooling/Heating)		dB(A)									
	Indoor (Cooling/Heating)		High									
Airflow Rate	Outdoor (Cooling/Heating)		High									
	Indoor/Outdoor (Cooling)		High									
Static pressure range (Standard)	Indoor (Cooling)		Pa									
	Indoor (Heating)		Pa									
Net Dimensions	Indoor		mm									
H x W x D	Outdoor		mm									
Weight	Indoor		kg									
	Outdoor		kg									
Connection Pipe Diameter (Liquid/Gas)	mm											
Drain Hose Diameter (I.D./O.D.)	mm											
Max. Pipe Length (Pre-Charge)	m											
Max. Height Difference	m											
Operating Range	Cooling		°CDB									
	Heating		°CDB									
Refrigerant	Type (Global Warming Potential)		R32 (675)									
	Charge		kg (CO2eq-T)									

Optional parts

Compact wired remote controller:	UTY-RCRGZ1	Long-life filter:	UTD-LFNA (36-54)	IR receiver unit:	UTY-LBTGM
Wired remote controller (touch panel):	UTY-RNRGZ5		UTD-LFNB (18-30)	External input and output PCB:	UTY-XCSX
Wired remote controller:	UTY-RLRG		UTD-LFNC (12-14)	External connect kit:	UTY-XWZXZG
	UTY-RNNGM	Silver Ion Filter:	UTD-HFNC (12/14)	External input and output PCB bracket:	UTZ-GXNA
	UTY-RVNGM		UTD-HFNB (18-30)	Network Converter for single split (DC power supply type):	UTY-VTGX
Simple remote controller (without operation model):	UTY-RHRG		UTD-HFNA (36-54)	Network Converter for single split (AC power supply type):	UTY-VTGVX
Simple remote controller:	UTY-RSRG	WLAN adapter:	UTY-TFSXZ1		
	UTY-RSNGM		FG-RC-WIF122	(Outdoor unit 30/36/45/54)	
Remote sensor unit:	UTY-XSXZ1		UTY-TFSXJ3	External connect kit:	UTY-XWZXZ3
External switch controller:	UTY-TERX		FG-AC-WIF121		

Dimensions

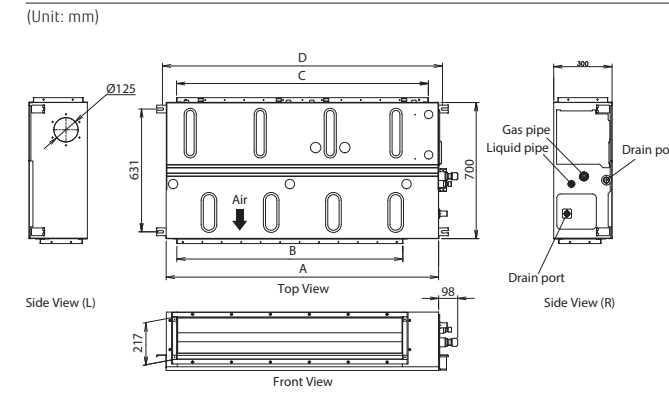

	ARXG12/14KHTAP	ARXG18/22/24/30KHTAP	ARXG36/45/54KHTAP
A	700	1,000	1,400
B	462	762	1,162
C	650	895	1,295
D	740	1,040	1,440

Medium Static Pressure Duct Standard



(30/36/45)

Easy maintenance

Structural improvement is attained by making the bottom panel in two pieces—front and rear. The internal fan casing is also manufactured in two pieces—upper and lower. As a result, the motor and fan can be easily accessed and maintained by removing the rear panel and the lower casing while leaving the main chassis in place.

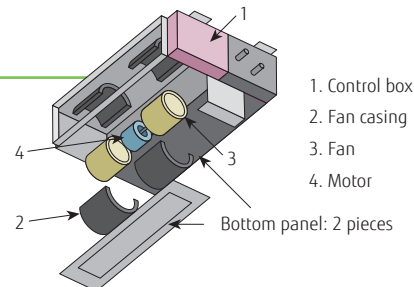

See below for case of rear-suction type

Slim & Compact design

Indoor Unit

The slim and compact design of the indoor unit, with the control box mounted on the side, allows installation in narrow spaces.

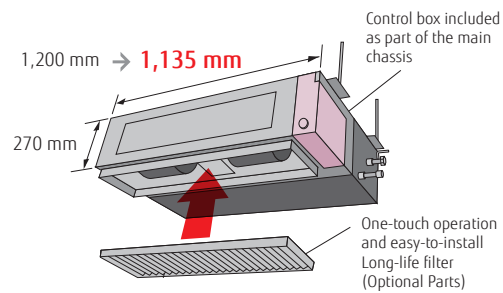

Outdoor Unit

The outdoor units for the 45,000 BTU and 54,000 BTU models have been completely redesigned. Easier installation is achieved for this compact and lightweight outdoor unit.

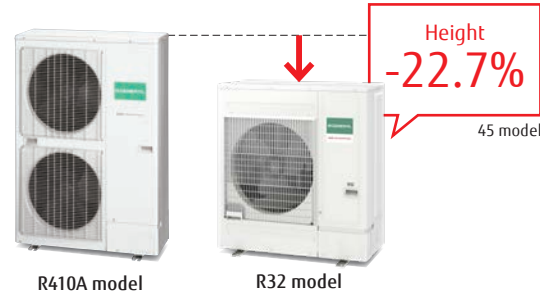

Two-direction drain piping

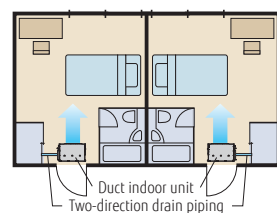

Link up with a variety of central control system (Option)

Centralized control including facilities and equipment in addition to air conditioning is possible by linking up with MODBUS, KNX interfaces.

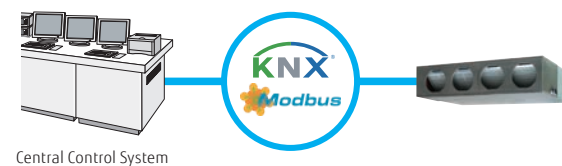

Model: ARXG22KMLB / ARXG24KMLA / ARXG30KMLA / ARXG36KMLA / ARXG45KMLA
ARXG36KMLA [3-phase] / ARXG45KMLA [3-phase]



Specifications

Model name	Indoor unit		ARXG22KMLB	ARXG24KMLA	ARXG30KMLA	ARXG36KMLA	ARXG45KMLA	ARXG36KMLA	ARXG45KMLA
	Outdoor unit		AOHG22KBTB	AOHG24KBTB	AOHG30KBTB	AOHG36KBTB	AOHG45KBTB	AOHG36KRTA	AOHG45KRTA
Power Source	Single phase, ~230 V, 50 Hz							3-phase, ~400 V, 50 Hz	
Capacity	Cooling	kW	6.0 (0.9-6.7)	6.8 (0.9-8.0)	8.5 (2.8-10.0)	9.5 (2.8-11.2)	12.1 (4.0-13.0)	9.5 (2.8-11.2)	12.1 (4.0-13.0)
	Heating		7.0 (0.9-8.0)	7.5 (0.9-9.1)	10.0 (2.7-11.2)	10.8 (2.7-12.7)	13.5 (4.2-15.2)	10.8 (2.7-12.7)	13.5 (4.2-15.2)
Input Power	Cooling/Heating	kW	1.78/1.87	2.14/1.97	2.65/2.63	2.97/2.88	4.22/3.84	2.97/2.88	4.22/3.84
EER	Cooling	W/W	3.37	3.18	3.21	3.20	2.87	3.20	2.87
	Heating		3.74	3.80	3.80	3.75	3.52	3.75	3.52
Pdesign	Cooling/Heating (-10°C)	kW	6.0/4.8	6.8/6.0	8.5/8.0	9.5/8.7	-	9.5/8.7	-
SEER	Cooling	W/W	6.10	6.20	6.23	6.10	-	6.10	-
	Heating		4.10	4.10	4.00	4.00	-	4.00	-
SCOP	Cooling	A	A++	A++	A++	A++	-	A++	-
	Heating		A+	A+	A+	A+	-	A+	-
Max. Operating Current	Cooling/Heating	A	12.6/12.6	13.6/13.6	22.6/22.6	22.6/22.6	28.5/28.5	10.5/10.5	14.0/14.0
Annual Energy Consumption	Cooling	kWh/a	344	384	477	545	-	545	-
	Heating		1,637	2,045	2,797	3,044	-	3,044	-
Moisture Removal	Cooling	l/h	2.1	2.5	2.5	3.0	4.0	3.0	4.0
	Heating								
Sound Pressure Level	Indoor (Cooling)	H/M/L/Q	31/29/27/25	31/29/27/25	39/35/30/26	39/35/30/26	42/38/32/28	39/35/30/26	42/38/32/28
	Indoor (Heating)		H/M/L/Q	31/29/27/25	31/29/27/25	42/35/30/26	42/35/30/26	42/35/30/26	42/38/32/28
Sound Power Level	Outdoor (Cooling/Heating)	High	51/51	53/54	53/55	55/55	57/57	55/55	57/57
	Indoor (Cooling/Heating)		High	60/62	60/62	65/69	65/70	68/70	65/70
Airflow Rate	Indoor/Outdoor (Cooling)	High	1,100/2,240	1,100/2,700	1,900/3,750	1,900/3,750	2,100/4,450	1,900/3,750	2,100/4,450
	Indoor/Outdoor (Heating)		High	1,100/1,960	1,100/2,700	2,100/3,750	2,100/3,750	2,100/4,450	2,100/3,750
Static pressure range (Standard)	Cooling	Pa	30 to 150 (35)	30 to 150 (35)	30 to 150 (47)	30 to 150 (47)	30 to 150 (60)	30-150 (47)	30-150 (60)
	Heating								
Net Dimensions H x W x D	Indoor	mm	270 x 1,135 x 700	270 x 1,135 x 700	270 x 1,135 x 700	270 x 1,135 x 700	270 x 1,135 x 700	270 x 1,135 x 700	270 x 1,135 x 700
	Outdoor		mm	632 x 799 x 290	716 x 820 x 315	788 x 940 x 320	788 x 940 x 320	998 x 940 x 320	788 x 940 x 320
Weight	Indoor	kg	35	35	38	38	39	38	39
	Outdoor		kg	38	42	52	52	67	53
Connection Pipe Diameter (Liquid/Gas)	Cooling	mm	6.35/12.70	6.35/12.70	9.52/15.88	9.52/15.88	9.52/15.88	9.52/15.88	9.52/15.88
	Heating								
Drain Hose Diameter (I.D./O.D.)	Cooling	mm	35.7/38.1	35.7/38.1	35.7/38.1	35.7/38.1	35.7/38.1	35.7/38.1	35.7/38.1
	Heating								
Max. Pipe Length (Pre-Charge)	Cooling	m	30 (20)	30 (20)	50 (30)	50 (30)	50 (30)	50 (30)	50 (30)
	Heating								
Max. Height Difference	Cooling	°CDB	-15 to 46	-15 to 46	-15 to 46	-15 to 46	-15 to 46	-15 to 46	-15 to 46
	Heating								
Refrigerant	Type (Global Warming Potential)	kg (CO2eq-T)	R32 (675)	R32 (675)	R32 (675)	R32 (675)	R32 (675)	R32 (675)	R32 (675)
	Charge			1.25 (0.844)	1.25 (0.844)	1.90 (1.283)	1.90 (1.283)	2.70 (1.823)	1.90 (1.283)

Optional parts

* For optional parts compatibility of Intesis devices, refer to the optional parts compatibility list Page C-048.

Compact wired remote controller:	UTY-RCRGZ1	WLAN adapter:	UTY-TFSXZ1	Network Converter for single split (DC power supply type):	UTY-VTGX
Wired remote controller (touch panel):	UTY-RNRGZ5		FG-RC-WIF1Z2	Network Converter for single split (AC power supply type):	UTY-VTGXV
Wired remote controller:	UTY-RLRG		UTY-TFSXJ3	Drain pump unit:	UTZ-PX1NBA
	UTY-RNNGM		FG-AC-WIF1Z1	Long-life filter:	UTD-LF25NA
	UTY-RVNGM		UTD-RF204	Silver Ion Filter:	UTD-HFND
Simple remote controller (without operation mode):	UTY-RHRG	Flange (Round):	UTD-SF04ST		
Simple remote controller:	UTY-RSRG	Flange (Square):	UTY-LBTGM	(Outdoor unit 30/36/45)	
	UTY-RSNGM	IR receiver unit:	UTY-XSZXZ1	External connect kit:	UTY-XWZXZ3
External switch controller:	UTY-TERX	Remote sensor unit:	UTY-XWZXZG		

Dimensions

(Unit: mm)

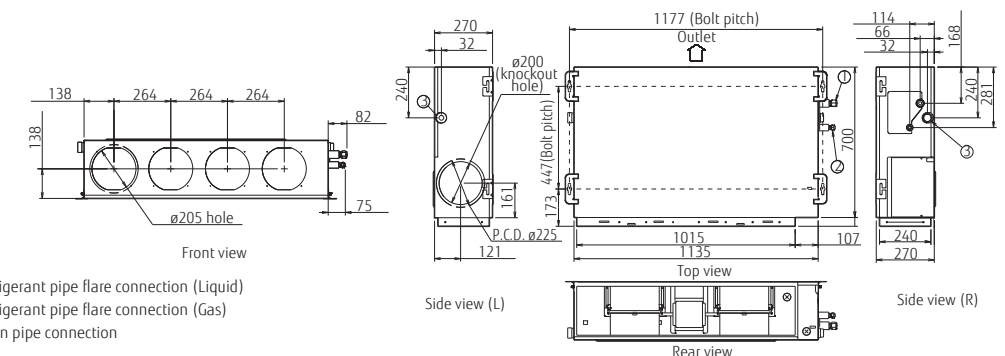

- ① Refrigerant pipe flare connection (Liquid)
- ② Refrigerant pipe flare connection (Gas)
- ③ Drain pipe connection

High Static Pressure Duct



Model: ARXG45KHTB / ARXG54KHTB
ARXG45KHTB [3-phase] / ARXG54KHTB [3-phase]



Specifications

Model name	Indoor unit		ARXG45KHTB	ARXG54KHTB	ARXG45KHTB	ARXG54KHTB
	Outdoor unit		AOHG45KHTB	AOHG54KHTB	AOHG45KRTA	AOHG54KRTA
Power Source	Single phase, ~230 V, 50 Hz			3-phase, ~400 V, 50 Hz		
Capacity	Cooling	kW	12.1 (4.0-14.0)	13.4 (5.0-14.5)	12.1 (4.0-14.0)	13.4 (5.0-14.5)
	Heating		13.5 (5.0-16.2)	15.5 (5.5-18.0)	13.5 (5.0-16.2)	15.5 (5.5-18.0)
Input Power	Cooling/Heating	kW	4.16/3.61	4.77/4.18	4.16/3.61	4.77/4.18
EER	Cooling	W/W	2.91	2.81	2.91	2.81
	Heating		3.74	3.71	3.74	3.71
COP	Cooling	W/W	-	-	-	-
	Heating		-	-	-	-
Pdesign	Cooling/Heating (-10°C)	kW	-	-	-	-
SEER	Cooling	W/W	-	-	-	-
	Heating		-	-	-	-
SCOP	Cooling	W/W	-	-	-	-
	Heating		-	-	-	-
Energy Efficiency Class	Cooling	-	-	-	-	
Max. Operating Current	Cooling/Heating	A	28.5/28.5	28.5/28.5	14.0/14.0	14.0/14.0
	Cooling	kWh/a	-	-	-	-
Annual Energy Consumption	Heating	kWh/a	-	-	-	-
	Moisture Removal	l/h	1.5	2.0	1.5	2.0
Sound Pressure Level	Indoor (Cooling)	H/M/L	47/43/40	47/43/40	47/43/40	47/43/40
	Indoor (Heating)	H/M/L	47/43/40	47/43/40	47/43/40	47/43/40
	Outdoor (Cooling/Heating)	High	57/57	57/59	57/57	57/59
Sound Power Level	Indoor (Cooling/Heating)	High	75/74	75/74	75/74	75/74
	Outdoor (Cooling/Heating)	High	71/71	73/73	71/71	73/73
	Indoor/Outdoor (Cooling)	High	3,350/4,450	3,350/4,450	3,350/4,450	3,350/4,450
Airflow Rate	Indoor/Outdoor (Heating)	High	3,350/4,450	3,350/4,450	3,350/4,450	3,350/4,450
	Static pressure range (Standard)	Pa	100 to 250 (100)	100 to 250 (100)	100 to 250 (100)	100 to 250 (100)
Net Dimensions H x W x D	Indoor	mm	400 × 1,050 × 500	400 × 1,050 × 500	400 × 1,050 × 500	400 × 1,050 × 500
	Outdoor	mm	998 × 940 × 320	998 × 940 × 320	998 × 940 × 320	998 × 940 × 320
Weight	Indoor	kg	46	46	46	46
	Outdoor	kg	67	67	67	67
Connection Pipe Diameter (Liquid/Gas)		mm	9.52/15.88	9.52/15.88	9.52/15.88	9.52/15.88
Drain port Diameter (I.D./O.D.)		mm	23.4/25.4	23.4/25.4	23.4/25.4	23.4/25.4
Max. Pipe Length (Pre-Charge)		m	50 (30)	50 (30)	50 (30)	50 (30)
Max. Height Difference		m	30	30	30	30
Operating Range	Cooling	°CDB	-15 to 46	-15 to 46	-15 to 46	-15 to 46
	Heating	°CDB	-15 to 24	-15 to 24	-15 to 24	-15 to 24
Refrigerant	Type (Global Warming Potential)		R32 (675)	R32 (675)	R32 (675)	R32 (675)
	Charge	kg (CO2eq-T)	2.70 (1.823)	2.70 (1.823)	2.70 (1.823)	2.70 (1.823)

Easy installation (Compact & Lightweight)

The indoor and outdoor units are designed to be compact and light by reducing the basic chassis size and the overall material weight.

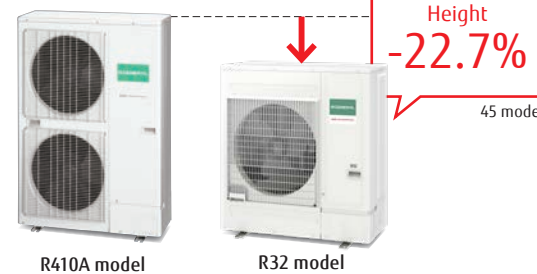
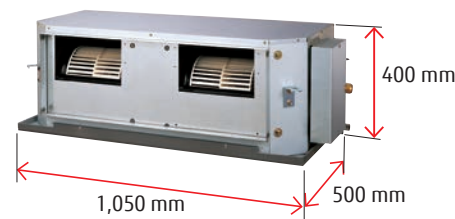

Design also suits high static pressure



Low noise

Slanted corners at the top help reduce turbulent airflow. Low noise is realized by adopting a plastic case and a plastic fan.

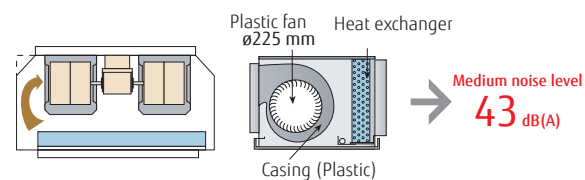

Link up with a variety of central control system (Option)

Centralized control including facilities and equipment in addition to air conditioning is possible by linking up with MODBUS, KNX interfaces.



Optional parts

* For optional parts compatibility of Intesis devices, refer to the optional parts compatibility list Page C-048.

Compact wired remote controller: UTY-RCRGZ1	Remote sensor unit: UTY-XSZXZ1	Network Converter for single split (DC power supply type): UTY-VTGX
Wired remote controller (touch panel): UTY-RNRGZ5	Long-life filter: UTD-LF60KA	Network Converter for single split (AC power supply type): UTY-VTGXV
Wired remote controller: UTY-RLRG	External switch controller: UTY-TERX	Silver Ion Filter: UTD-HFKB
Simple remote controller: UTY-RSRG	WLAN adapter: UTY-TFSXZ1	
	UTY-RHRG	
IR Receiver unit: UTY-LBTGM	UTY-TFSXJ3	(Outdoor unit)
External connect kit: UTY-XWZXZG	FG-AC-WIF1Z1	External connect kit: UTY-XWZXZ3
	External input and output PCB: UTY-XCSX+UTZ-GXEA	

Dimensions

(Unit: mm)

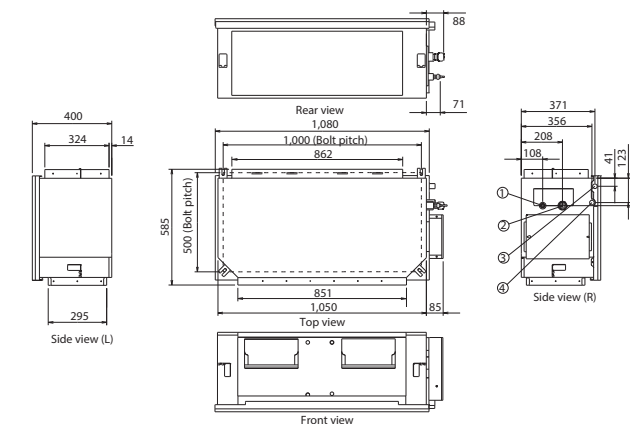

- ① Refrigerant pipe flare connection (Liquid)
- ② Refrigerant pipe flare connection (Gas)
- ③ Drain pipe connection (Safety drain pan)
- ④ Drain pipe connection (Main drain pan)

High Static Pressure Duct



Model: ARHG60LHTA [3-phase]



Specifications

Model name	Indoor unit		Outdoor unit	
	ARHG60LHTA	AOHG60LATT	ARHG60LHTA	AOHG60LATT
Power Source	3-phase, ~400 V, 50 Hz			
Capacity	Cooling	kW	15.0 (6.2-17.5)	
	Heating	kW	18.0 (6.2-20.0)	
Input Power	Cooling/Heating		kW	
EER	Cooling		W/W	
COP	Heating		W/W	
Max. Operating Current	Cooling/Heating		A	
Moisture Removal			l/h	
Sound Pressure	Indoor (Cooling)	H/M/L/Q	dB(A)	
	Indoor (Heating)	H/M/L/Q	45/40/36/-	
	Outdoor (Cooling/Heating)	High	56/58	
Airflow Rate	Indoor/Outdoor (Cooling)	High	m³/h	
	Indoor/Outdoor (Heating)	High	3,550/6,900 3,550/7,300	
Static pressure range (Standard)			Pa	
Net Dimensions H x W x D	Indoor	mm	425 x 1,250 x 490	
	Outdoor	mm	1,290 x 900 x 330	
Weight	Indoor	kg	54	
	Outdoor	kg	104	
Connection Pipe Diameter (Liquid/Gas)			mm	
Drain Hose Diameter (I.D./O.D.)			mm	
Max. Pipe Length (Pre-Charge)			m	
Max. Height Difference			m	
Operating Range	Cooling	°CDB	-15 to 46	
	Heating	°CDB	-15 to 24	
Refrigerant	Type (Global Warming Potential)		R410A (2,088)	
	Charge	kg (CO2eq-T)	3.45 (7.204)	

High energy efficiency

Much greater efficiency is achieved by the use of all-DC inverter technology.

Design also corresponding to high static pressure

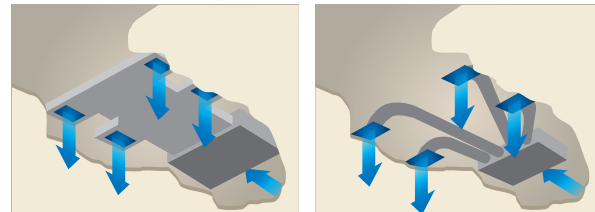
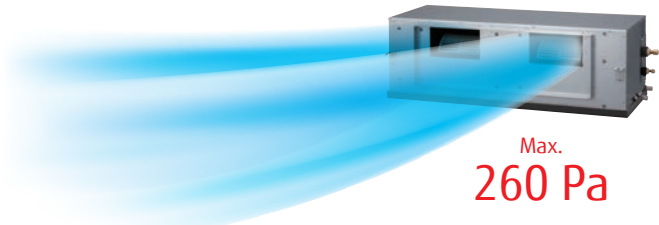

Easy installation (Compact & Lightweight)

The indoor unit is designed to be compact and light by reducing the basic chassis size and the overall material weight.

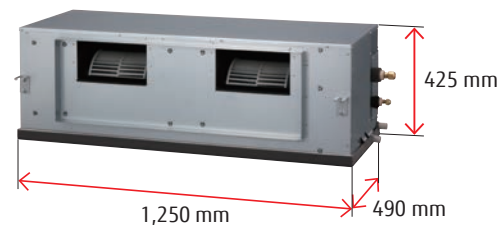

Low noise

Slanted corners at the top help reduce turbulent airflow. Low noise is realized by adopting a plastic case and a plastic fan.

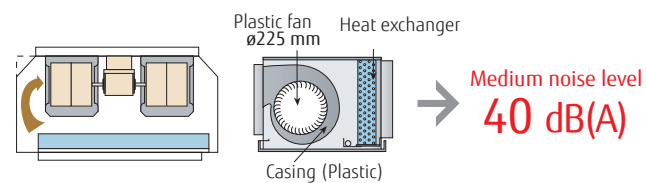

Link up with a variety of central control system (Option)

Centralized control including facilities and equipment in addition to air conditioning is possible by linking up with MODBUS, KNX interfaces.



Optional parts

* For optional parts compatibility of Intesis devices, refer to the optional parts compatibility list Page C-048.

Wired remote controller:	UTY-RNNGM	Network Converter for single split (DC power supply type):	UTY-VTGX
Wired remote controller:	UTY-RVNGM	Network Converter for single split (AC power supply type):	UTY-VTGXV
Simple remote controller:	UTY-RSNGM	External connect kit:	UTD-ECS5A
External switch controller:	UTY-TERX	IR receiver unit:	UTY-LRHGM
WLAN adapter:	UTY-TFNXZ1		
	FG-RC-WIF1Z2	(Outdoor unit)	
Remote sensor unit:	UTY-XSZXZ1	External connect kit:	UTY-XWZXZ2

Dimensions

(Unit: mm)

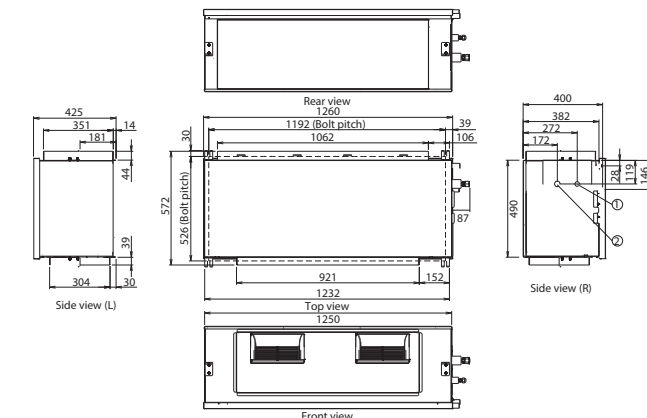

- ① Refrigerant pipe flare connection (Liquid)
- ② Refrigerant pipe flare connection (Gas)
- ③ Drain pipe connection (Safety drain pan)
- ④ Drain pipe connection (Main drain pan)

Big Duct



Splittable, lightweight, and compact design

The indoor unit can be split into a fan unit and a heat exchanger unit to make installation easier.

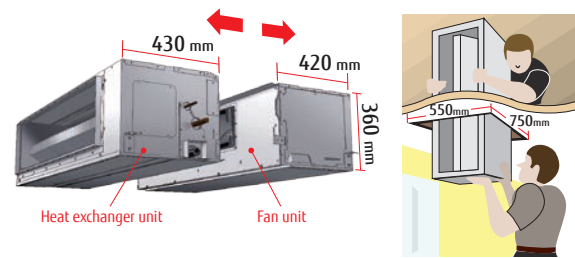

Quiet operation

The combination of a V-shaped heat exchanger, an air stabilizer, and a high-efficiency DC fan motor enables this compact unit to operate quietly.

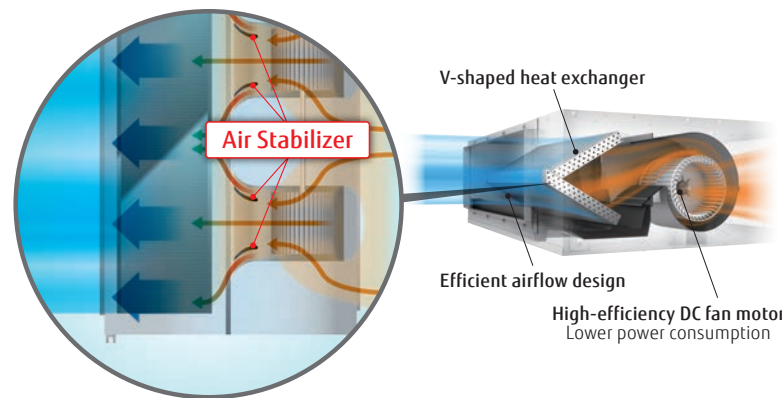

Automatic airflow adjustment function

The optimum airflow can be set automatically to facilitate faster installation.



Link up with a variety of central control system (Option)

Centralized control including facilities and equipment in addition to air conditioning is possible by linking up with MODBUS, KNX interfaces.



Model: ARHG72LHTA / ARHG90LHTA



Wired RC



Specifications

Model name	Indoor unit		ARHG72LHTA	ARHG90LHTA
	Outdoor unit		AOHG72LRLA	AOHG90LRLA
Power Source	Indoor		Single phase, ~230 V, 50 Hz	
	Outdoor		3-phase, ~400 V, 50 Hz	
Capacity	Cooling	kW	19.0 (8.4-20.9)	22.0 (10.3-24.2)
	Heating		22.4 (7.2-24.6)	27.0 (8.5-29.7)
Input Power	Cooling/Heating		6.46/6.59	7.77/8.18
	Cooling	W/W	2.94	2.83
EER	Heating		3.40	3.30
COP	Indoor (Cooling/Heating)		-	-
	Outdoor (Cooling/Heating)		-	-
Max. Operating Current	Indoor (Cooling/Heating)		-	-
	Outdoor (Cooling/Heating)		-	-
Moisture Removal	Indoor (Cooling)		4.5	6.0
	Indoor (Heating)		4.5	6.0
Sound Pressure	Indoor (Cooling)	H/M/L/Q	46/43/41/39	47/44/42/40
	Indoor (Heating)		46/43/41/39	47/44/42/40
Airflow Rate	Outdoor (Cooling/Heating)	High	55/55	55/57
	Indoor/Outdoor (Cooling)		4,300/8,400	4,300/8,400
Static pressure range (Standard)	Indoor/Outdoor (Heating)		4,300/8,400	4,300/9,000
	High		4,300/8,400	4,300/9,000
Net Dimensions H x W x D	Indoor		50 to 150 (72)	50 to 200 (72)
	Outdoor		360 × 1,400 × 850	360 × 1,400 × 850
Weight	Indoor		69	80
	Outdoor		165	174
Connection Pipe Diameter (Liquid/Gas)	Indoor		12.7/25.4	12.7/25.4
	Outdoor		25/32	25/32
Drain Hose Diameter (I.D./O.D.)	Indoor		100 (30)	100 (30)
	Outdoor		30	30
Max. Pipe Length (Pre-Charge)	Indoor		-15 to 46	-15 to 46
	Outdoor		-20 to 24	-20 to 24
Max. Height Difference	Cooling		-15 to 46	-15 to 46
	Heating		-20 to 24	-20 to 24
Operating Range	Type (Global Warming Potential)		R410A (2,088)	R410A (2,088)
	Charge		5.6 (11.693)	7.1 (14.825)

Optional parts

* For optional parts compatibility of Intesis devices, refer to the optional parts compatibility list Page C-048.

Compact wired remote controller:	UTY-RCRGZ1	WLAN adapter:	UTY-TFSXZ1	Network Converter for single split (DC power supply type):	UTY-VTGX
Wired remote controller (touch panel):	UTY-RNRGZ5		FG-RC-WIF1Z2	Network Converter for single split (AC power supply type):	UTY-VTGXV
Wired remote controller:	UTY-RLRG3		UTY-TFSXJ3	IR receiver unit:	UTY-LBTGM
	UTY-RNNGM		FG-AC-WIF1Z1	Silver Ion Filter:	UTY-LRHGM
	UTY-RVNGM	External input and output PCB:	UTY-XCSX		UTD-HFKA
Simple remote controller (without operation mode):	UTY-RHRG	Remote sensor unit:	UTY-XSZXZ1		
Simple remote controller:	UTY-RSRG	Long-life filter:	UTD-LFKA	(Outdoor unit)	
	UTY-RSNGM	External connect kit:	UTY-XWZXZG	External connect kit:	UTY-XWZXZ3
External switch controller:	UTY-TERX	Drain pump unit:	UTZ-PXINAB		

Dimensions

(Unit: mm)

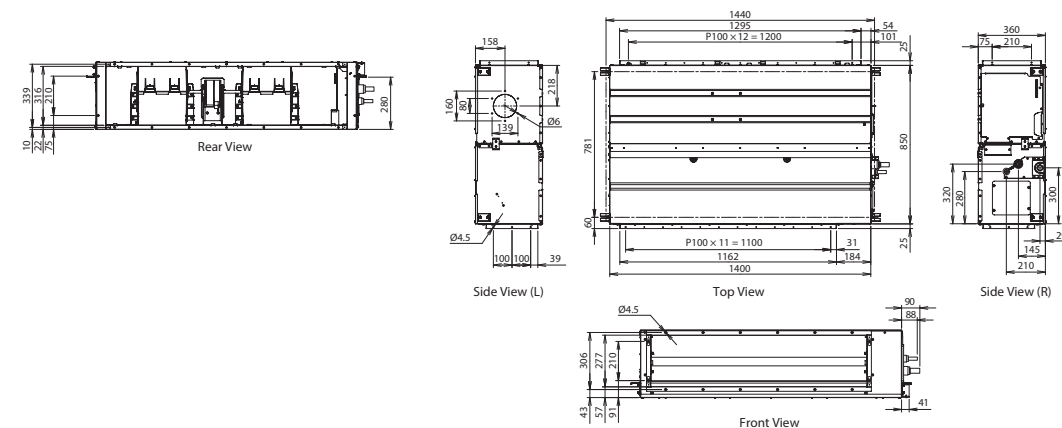

Floor Compact Size



Model: AGHG09KVCA / AGHG12KVCA / AGHG14KVCA



Specifications

Model name	Indoor unit		AGHG09KVCA	AGHG12KVCA	AGHG14KVCA
	Outdoor unit		AOHG09KVCA	AOHG12KVCA	AOHG14KVCA
Power Source	Single phase, ~230 V, 50 Hz				
Capacity	Cooling	kW	2.5 (0.9-3.5)	3.5 (0.9-4.0)	4.2 (0.9-5.2)
	Heating	kW	3.5 (0.9-5.1)	4.5 (0.9-5.3)	5.2 (0.9-6.3)
Input Power	Cooling/Heating		0.53/0.81	0.88/1.22	1.06/1.41
	Cooling	W/W	4.70	4.00	3.95
COP	Heating		4.30	3.70	3.70
	Cooling/Heating (-10°C)	kW	2.50/2.60	3.50/3.50	4.20/4.20
SEER	Cooling	W/W	8.50	8.20	8.10
SCOP	Heating (Average)		4.30	4.10	4.00
	Cooling		A+++	A++	A++
Energy Efficiency Class	Heating (Average)		A+	A+	A+
	Cooling/Heating	A	7.0/8.5	7.0/8.5	11.0/12.0
Max. Operating Current	Cooling		103	149	181
	Heating (Average)		845	1,192	1,466
Annual Energy Consumption	Cooling		1.3	1.8	2.1
	Heating				
Moisture Removal	Indoor (Cooling)	H/M/L/Q	40/35/29/22	40/35/29/22	44/38/31/22
	Indoor (Heating)	H/M/L/Q	41/35/29/22	41/35/29/22	43/37/29/22
Sound Pressure Level	Outdoor (Cooling/Heating)	High	43/47	45/51	51/50
	Indoor (Cooling/Heating)	High	53/54	53/54	57/56
Sound Power Level	Outdoor (Cooling/Heating)	High	58/61	61/64	63/63
	Indoor/Outdoor (Cooling)	High	570/1,530	570/1,530	650/2,210
Airflow Rate	Indoor/Outdoor (Heating)	High	600/1,510	600/1,510	650/2,100
	Indoor	mm	600 × 740 × 200	600 × 740 × 200	600 × 740 × 200
Net Dimensions H x W x D	Outdoor	mm	542 × 799 × 290	542 × 799 × 290	632 × 799 × 290
	Indoor	kg	14	14	14
Weight	Outdoor	kg	31	31	38
	Connection Pipe Diameter (Liquid/Gas)	mm	6.35/9.52	6.35/9.52	6.35/9.52
Drain Hose Diameter (I.D./O.D.)	13.8/15.8 to 16.7				
Max. Pipe Length (Pre-Charge)	20 (15)				
Max. Height Difference	Cooling	°CDB	-10 to 46	-10 to 46	-10 to 46
	Heating	°CDB	-15 to 24	-15 to 24	-15 to 24
Operating Range	Type (Global Warming Potential)		R32 (675)	R32 (675)	R32 (675)
	Charge	kg (CO2eq-T)	0.85 (0.574)	0.85 (0.574)	0.94 (0.635)

High energy saving

The Floor 09 class achieves a top-class SEER of 8.50 and an A+++ seasonal efficiency rank for cooling. The Floor 09 class achieves an improved SCOP of 4.30 and an A+ seasonal efficiency rank for heating.



Flexible & easy installation

The compact and whole-surface suction design provides flexible installation options, including floor-standing, embedded, half concealed, and wall mount installation to match the room layout.

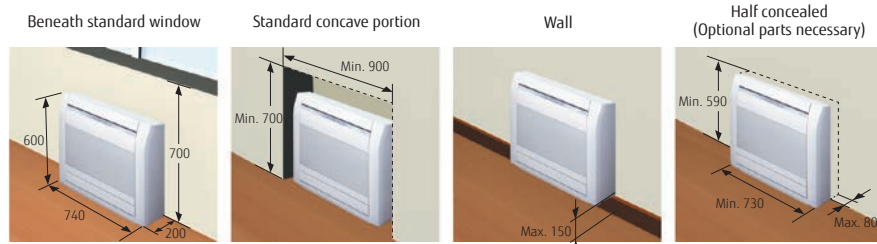

* Concaved position installation with concealment is prohibited.

Low ambient operation

Factory-guaranteed cooling operation down to -10°C ambient temperature.

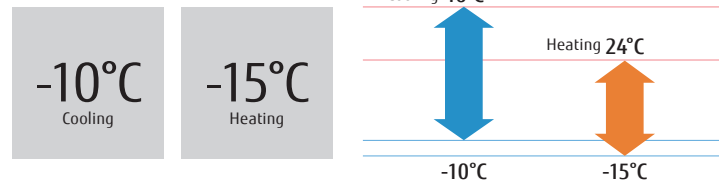

Smart device control (Option)

With the optional WLAN adapter installed in the air conditioner, you can control it from anywhere with your smart device. WLAN adapter can be installed easily without specialized installation work.



10°C heat

The room temperature can be set to go no lower than 10°C, thus ensuring that the room does not get too cold when not occupied.

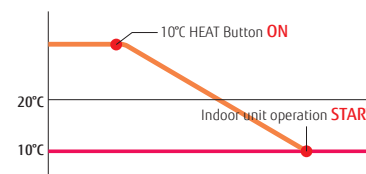

Optional parts

* For optional parts compatibility of Intesis devices, refer to the optional parts compatibility list Page C-048.

Compact wired remote controller:	UTY-RCRGZ1	External switch controller:	UTY-TERX	Network Converter for single split (DC power supply type):	UTY-VTGX
Wired remote controller (touch panel):	UTY-RNRGZ5	WLAN adapter:	UTY-TFSXZ1	Network Converter for single split (AC power supply type):	UTY-VTGXV
Wired remote controller:	UTY-RLRG		FG-AC-WIF1Z1	Silver Ion Filter:	UTR-FA03-5
Simple remote controller (without operation mode):	UTY-RHRG		UTY-TFSXJ3	External connect kit:	UTY-XWZX25
Simple remote controller:	UTY-RSRG	Half concealed kit:	UTR-STA	Communication kit:	UTY-TWRXZ3

Dimensions

(Unit: mm)

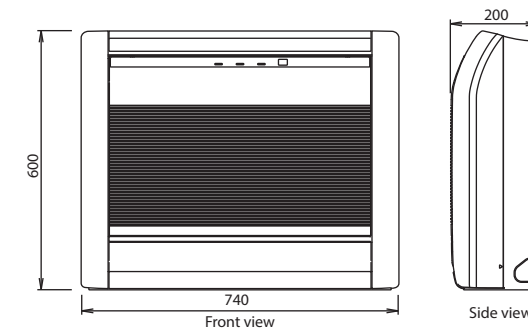

Ceiling

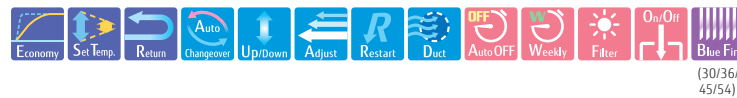
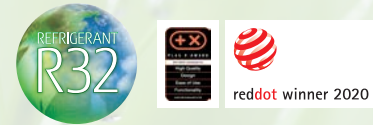

Light elegant design

The light-elegant, gently curved surface gives a sense of comfort and well-being.



Easy installation

The indoor unit can be easily installed under the ceiling thanks to the uniquely designed mounting kit.

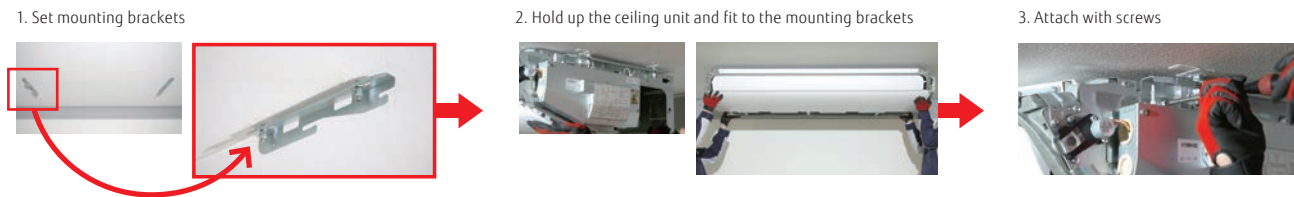

Easy maintenance

The front panel can be opened without removing it for safe & speedy maintenance.



The drain pan can be removed for cleaning.



Components in the control box can be easily accessed from the wide side opening.



Flexible installation

The drain hose and pipe can be contained in the casing and connected in the right, left, angled, or downward direction.



Link up with a variety of central control system (Option)

Centralized control including facilities and equipment in addition to air conditioning is possible by linking up with MODBUS, KNX interfaces.



Model: ABHG18KRTA / ABHG22KRTA / ABHG24KRTA / ABHG30KRTA / ABHG36KRTA / ABHG45KRTA / ABHG36KRTA [3-phase] / ABHG45KRTA [3-phase] / ABHG54KRTA [3-phase]



Specifications

Model name	Indoor unit						Outdoor unit				
	ABHG18KRTA	ABHG22KRTA	ABHG24KRTA	ABHG30KRTA	ABHG36KRTA	ABHG45KRTA	ABHG36KRTA	ABHG45KRTA	ABHG54KRTA		
Power Source	Single phase, ~230 V, 50 Hz						3-phase, ~400 V, 50 Hz				
Capacity	Cooling	5.2 (0.9-5.9)	6.0 (0.9-6.7)	6.8 (0.9-8.0)	8.5 (2.8-10.0)	9.5 (2.8-11.2)	12.1 (4.0-13.5)	9.5 (2.8-11.2)	12.1 (4.0-13.5)	13.4 (4.5-14.5)	
	Heating	6.0 (0.9-7.5)	7.0 (0.9-8.0)	7.5 (0.9-9.1)	10.0 (2.7-11.2)	10.8 (2.7-12.7)	13.5 (4.2-16.2)	10.8 (2.7-12.7)	13.5 (4.2-16.2)	15.5 (4.7-16.5)	
Input Power	Cooling/Heating	1.55/1.62	1.87/1.95	2.14/1.97	2.65/2.77	2.96/2.88	4.22/3.84	2.96/2.88	4.22/3.84	4.45/4.43	
EER	Cooling	3.35	3.21	3.18	3.21	3.21	2.87	3.21	2.87	3.01	
	Heating	3.70	3.59	3.81	3.61	3.75	3.52	3.75	3.52	3.50	
Pdesign	Cooling/Heating (-10°C)	5.2/4.4	6.0/4.8	6.8/6.0	8.5/8.0	9.5/8.7	-	9.5/8.7	-	-	
SEER	Cooling	6.2	6.1	6.2	6.1	6.37	-	6.37	-	-	
SCOP	Heating (Average)	4.1	4.0	4.1	4.0	4.21	-	4.21	-	-	
Energy Efficiency Class	Cooling	A++	A++	A++	A++	A++	-	A++	-	-	
	Heating (Average)	A+	A+	A+	A+	A+	-	A+	-	-	
Max. Operating Current	Cooling/Heating	12.1/12.1	12.6/12.6	13.6/13.6	22.6/22.6	22.6/22.6	28.5/28.5	10.5/10.5	14.0/14.0	14.0/14.0	
Annual Energy Consumption	Cooling	293	344	384	486	524	-	524	-	-	
	Heating	1,501	1,677	2,042	2,796	2,904	-	2,904	-	-	
Moisture Removal		2.0	2.5	2.2	3.0	2.6	4.5	2.6	4.5	5.0	
Sound Pressure Level	Indoor (Cooling)	H/M/L/Q	38/36/33/31	42/37/34/31	41/36/32/29	45/40/35/32	44/40/37/32	45/41/39/34	44/40/37/32	45/41/39/34	48/44/41/38
	Indoor (Heating)	H/M/L/Q	38/36/33/31	42/37/34/31	41/36/32/29	45/40/35/32	44/40/37/32	45/41/39/34	44/40/37/32	45/41/39/34	48/44/41/38
Sound Power Level	Outdoor (Cooling/Heating)	High	50/50	51/51	53/54	53/55	55/55	57/57	55/55	57/57	57/59
	Outdoor (Cooling/Heating)	High	53/53	57/57	56/56	60/60	59/59	60/60	59/59	60/60	63/63
Airflow Rate	Indoor/Outdoor (Cooling)	High	840/2,160	900/2,240	1,230/2,700	1,400/3,750	1,850/3,750	1,900/4,450	1,850/3,750	1,900/4,450	2,100/4,450
	Indoor/Outdoor (Heating)	High	840/1,830	900/1,960	1,230/2,700	1,400/3,750	1,800/3,750	1,850/4,450	1,800/3,750	1,850/4,450	2,100/4,450
Net Dimensions	Indoor	mm	235 × 1,080 × 705	235 × 1,080 × 705	235 × 1,390 × 705	235 × 1,390 × 705	235 × 1,700 × 705	235 × 1,700 × 705	235 × 1,700 × 705	235 × 1,700 × 705	235 × 1,700 × 705
H x W x D	Outdoor	mm	632 × 799 × 290	632 × 799 × 290	716 × 820 × 315	788 × 940 × 320	788 × 940 × 320	998 × 940 × 320	788 × 940 × 320	998 × 940 × 320	998 × 940 × 320
Weight	Indoor	kg	24	24	31	31	38	38	38	38	
	Outdoor	kg	36	38	42	52	52	67	53	67	
Connection Pipe Diameter (Liquid/Gas)		mm	6.35/12.7	6.35/12.7	6.35/12.7	9.52/15.88	9.52/15.88	9.52/15.88	9.52/15.88	9.52/15.88	
Drain Hose Diameter (I.D./O.D.)		mm	25/32	25/32	25/32	25/32	25/32	25/32	25/32	25/32	
Max. Pipe Length (Pre-Charge)		m	30 (20)	30 (20)	30 (20)	50 (30)	50 (30)	50 (30)	50 (30)	50 (30)	
Max. Height Difference		m	20	25	25	30	30	30	30	30	
Operating Range	Cooling	°CDB	-15 to 46	-15 to 46	-15 to 46	-15 to 46	-15 to 46	-15 to 46	-15 to 46	-15 to 46	
	Heating	°CDB	-15 to 24	-15 to 24	-15 to 24	-15 to 24	-15 to 24	-15 to 24	-15 to 24	-15 to 24	
Refrigerant	Type (Global Warming Potential)		R32 (675)	R32 (675)	R32 (675)	R32 (675)	R32 (675)	R32 (675)	R32 (675)	R32 (675)	
	Charge	kg (CO2eq-T)	1.02 (0.689)	1.25 (0.844)	1.25 (0.844)	1.90 (1.283)	1.90 (1.283)	2.70 (1.823)	1.90 (1.283)	2.70 (1.823)	2.70 (1.823)

Optional parts

* For optional parts compatibility of Inesis devices, refer to the optional parts compatibility list Page C-048.

Compact wired remote controller:	UTY-RCRGZ1	WLAN adapter:	UTY-TFSXZ1	Network Converter for single split (DC power supply type):	UTY-VTGX
Wired remote controller (touch panel):	UTY-RNRGZ5		UTY-TFSXJ3	Network Converter for single split (AC power supply type):	UTY-VTGXV
Wired remote controller:	UTY-RLRG		FG-AC-WIFI21	External switch controller:	UTY-TERX
Simple remote controller (without operation mode):	UTY-RHRG	Drain pump unit:	UTR-DPB24T		
Simple remote controller:	UTY-RSRG	IR receiver unit:	UTY-LBTGH		
External input and output PCB:	UTY-XCSX	L-type piping kit:	UTP-FX24A (18/22/24)		
External input and output PCB box:	UTZ-GXEA	Communication kit:	UTP-FX35A (30/36/45/54)		
External connect kit:	UTY-XWZXZG		UTY-TWRXZ3		

Dimensions

(Unit: mm)

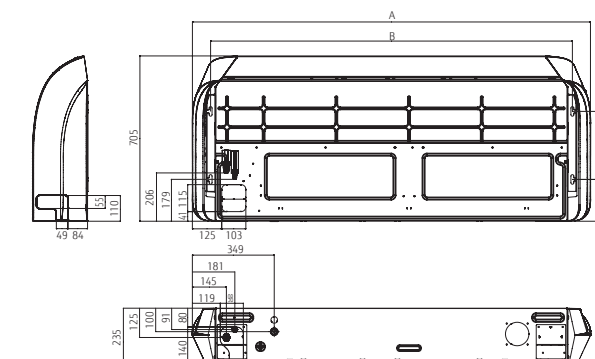

	ABHG18/22KRTA	ABHG24/30KRTA	ABHG36/45/54KRTA
A	1,080	1,390	1,700
B	923	1,233	1,543



Wall-mounted W-LAN Adapter Option Models Specifications

Designer Series Cool Beauty Design



Model name	Indoor unit		ASHG07KETE ASHG07KETE-B	ASHG09KETE ASHG09KETE-B	ASHG12KETE ASHG12KETE-B	ASHG14KETE ASHG14KETE-B
	Outdoor unit		AOHG07KETA	AOHG09KETA	AOHG12KETA	AOHG14KETA
Power Source	Single phase, ~230 V, 50 Hz					
Capacity	Cooling	kW	2.0 (0.9 - 3.0)	2.5 (0.9 - 3.2)	3.4 (0.9 - 3.9)	4.2 (0.9 - 4.4)
	Heating		2.5 (0.9 - 3.4)	2.8 (0.9 - 4.0)	4.0 (0.9 - 5.3)	5.4 (0.9 - 6.0)
Input Power	Cooling/Heating	kW	0.450/0.555	0.630/0.620	0.935/0.960	1.220/1.410
EER	Cooling	W/W	4.43	3.97	3.65	3.44
	Heating		4.52	4.52	4.17	3.83
Pdesign	Cooling/Heating (-10°C)	kW	2.0/2.3	2.5/2.4	3.4/2.5	4.2/4.0
SEER	Cooling	W/W	7.40	7.40	7.30	6.90
SCOP	Heating (Average)	W/W	4.10	4.10	4.40	4.10
Energy Efficiency Class	Cooling		A++	A++	A++	A++
	Heating (Average)		A+	A+	A+	A+
Max. Operating Current	Cooling/Heating	A	6.5/9.0	6.5/9.0	6.5/9.0	6.5/9.0
Annual Energy Consumption	Cooling	kWh/a	95	118	163	213
	Heating		785	819	795	1,367
Moisture Removal		l/h	1.0	1.3	1.8	2.1
Sound Pressure Level	Indoor (Cooling)	H/M/L/Q	38/33/29/20	40/34/29/20	40/35/30/20	43/36/30/20
	Indoor (Heating)	H/M/L/Q	41/35/31/22	42/36/31/22	42/38/33/22	44/39/33/24
Sound Power Level	Outdoor (Cooling/Heating)	High	46/46	46/46	50/50	50/50
	Indoor (Cooling/Heating)	High	54/56	55/57	55/58	57/59
Airflow Rate	Indoor/Outdoor (Cooling)	High	650/1,650	700/1,650	700/1,700	770/1,680
	Indoor/Outdoor (Heating)	High	720/1,450	750/1,450	770/1,470	800/1,580
Net Dimensions H x W x D	Indoor	mm	295 x 950 (wall side: 840) x 230			
	Outdoor	mm	541 x 663 x 290	541 x 663 x 290	541 x 663 x 290	542 x 799 x 290
Weight	Indoor	kg	11	11	11	11.5
	Outdoor	kg	23	23	25	31
Connection Pipe Diameter (Liquid/Gas)		mm	6.35/9.52	6.35/9.52	6.35/9.52	6.35/9.52
Drain Hose Diameter (I.D./O.D.)		mm	13.8/15.0 to 16.8	13.8/15.0 to 16.8	13.8/15.0 to 16.8	13.8/15.0 to 16.8
Max. Pipe Length (Pre-Charge)		m	20 (15)	20 (15)	20 (15)	20 (15)
Max. Height Difference		m	15	15	15	15
Operating Range	Cooling	°CDB	-10 to 46	-10 to 46	-10 to 46	-10 to 46
	Heating		-15 to 24	-15 to 24	-15 to 24	-15 to 24
Refrigerant	Type (Global Warming Potential)		R32 (675)	R32 (675)	R32 (675)	R32 (675)
	Charge	kg (CO2eq-T)	0.6 (0.405)	0.6 (0.405)	0.7 (0.473)	0.85 (0.574)

Designer Series High Spec & Design



Model name	Indoor unit		ASHG07KGTE	ASHG09KGTE	ASHG12KGTE	ASHG14KGTE
	Outdoor unit		AOHG07KGCA	AOHG09KGCA	AOHG12KGCA	AOHG14KGCA
Power Source	Single phase, ~230 V, 50 Hz					
Capacity	Cooling	kW	2.0 (0.9-3.2)	2.5 (0.9-3.4)	3.4 (0.9-4.1)	4.2 (0.9-4.5)
	Heating		2.5 (0.9-5.2)	2.8 (0.9-5.4)	4.0 (0.9-6.1)	5.4 (0.9-6.4)
Input Power	Cooling/Heating	kW	0.400/0.500	0.555/0.560	0.805/0.910	1.175/1.350
EER	Cooling	W/W	5.00	4.50	4.22	3.57
	Heating		5.00	5.00	4.40	4.00
Pdesign	Cooling/Heating (-10°C)	kW	2.0/2.3	2.5/2.4	3.4/2.5	4.2/4.0
SEER	Cooling	W/W	9.10	9.20	9.20	8.30
SCOP	Heating (Average)	W/W	5.30	5.20	5.20	4.50
Energy Efficiency Class	Cooling		A+++	A+++	A+++	A++
	Heating (Average)		A+++	A+++	A+++	A+
Max. Operating Current	Cooling/Heating	A	6.5/9.0	6.5/9.0	6.5/9.0	9.0/10.5
Annual Energy Consumption	Cooling	kWh/a	77	95	129	177
	Heating		607	645	672	1,242
Moisture Removal		l/h	1.0	1.3	1.8	2.1
Sound Pressure Level	Indoor (Cooling)	H/M/L/Q	38/33/29/19	40/34/29/19	40/35/30/19	43/36/30/20
	Indoor (Heating)	H/M/L/Q	41/35/31/21	42/36/31/21	42/38/33/21	44/39/33/24
Sound Power Level	Outdoor (Cooling/Heating)	High	46/46	46/48	50/50	50/50
	Indoor (Cooling/Heating)	High	54/56	55/57	56/58	57/59
Airflow Rate	Indoor/Outdoor (Cooling)	High	650/1,610	700/1,610	700/1,680	770/1,680
	Indoor/Outdoor (Heating)	High	720/1,560	750/1,610	770/1,580	800/1,580
Net Dimensions H x W x D	Indoor	mm	270 x 834 x 215	270 x 834 x 215	270 x 834 x 215	270 x 834 x 215
	Outdoor	mm	542 x 799 x 290	542 x 799 x 290	542 x 799 x 290	542 x 799 x 290
Weight	Indoor	kg	10	10	10	10
	Outdoor	kg	30	30	31	32
Connection Pipe Diameter (Liquid/Gas)		mm	6.35/9.52			
Drain Hose Diameter (I.D./O.D.)		mm	13.8/15.0 to 16.8			
Max. Pipe Length (Pre-Charge)		m	20 (15)			
Max. Height Difference		m	15			
Operating Range	Cooling	°CDB	-10 to 46			
	Heating		-15 to 24			
Refrigerant	Type (Global Warming Potential)		R32 (675)			
	Charge	kg (CO2eq-T)	0.75 (0.506)	0.75 (0.506)	0.85 (0.574)	0.85 (0.574)

Standard Series High-Efficiency & Comfort



Model name	Indoor unit		ASHG07KMCE	ASHG09KMCE	ASHG12KMCE	ASHG14KMCE
	Outdoor unit		AOHG07KMCC	AOHG09KMCC	AOHG12KMCC	AOHG14KMCC
Power Source	Single phase, ~230 V, 50 Hz					
Capacity	Cooling	kW	2.0 (0.9-3.0)	2.5 (0.9-3.2)	3.4 (0.9-3.9)	4.2 (0.9-4.4)
	Heating		2.5 (0.9-3.4)	2.8 (0.9-4.0)	4.0 (0.9-5.3)	5.4 (0.9-6.0)
Input Power	Cooling/Heating	kW	0.450/0.555	0.630/0.620	0.935/0.960	1.220/1.410
EER	Cooling	W/W	4.43	3.97	3.65	3.44
	Heating		4.52	4.52	4.17	3.83
Pdesign	Cooling/Heating (-10°C)	kW	2.0/2.3	2.5/2.4	3.4/2.5	4.2/4.0
SEER	Cooling	W/W	7.40	7.40	7.30	6.90
SCOP	Heating (Average)	W/W	4.10	4.10	4.40	4.10
Energy Efficiency Class	Cooling		A++	A++	A++	A++
	Heating (Average)		A+	A+	A+	A+
Max. Operating Current	Cooling/Heating	A	6.5/9.0	6.5/9.0	6.5/9.0	6.5/9.0
Annual Energy Consumption	Cooling	kWh/a	95	118	163	213
	Heating		785	819	795	1,367
Moisture Removal		l/h	1.0	1.3	1.8	2.1
Sound Pressure Level	Indoor (Cooling)	H/M/L/Q	38/33/29/20	40/34/29/20	40/35/30/20	43/36/30/20
	Indoor (Heating)	H/M/L/Q	41/35/31/22	42/36/31/22	42/38/33/22	44/39/33/24
Sound Power Level	Outdoor (Cooling/Heating)	High	46/46	46/46	50/50	50/50
	Indoor (Cooling/Heating)	High	54/56	55/57	55/58	57/59
Airflow Rate	Indoor/Outdoor (Cooling)	High	650/1,650	700/1,650	700/1,700	770/1,680
	Indoor/Outdoor (Heating)	High	720/1,450	750/1,450	770/1,470	800/1,580
Net Dimensions H x W x D	Indoor	mm	270 x 834 x 222	270 x 834 x 222	270 x 834 x 222	270 x 834 x 222
	Outdoor	mm	541 x 663 x 290	541 x 663 x 290	541 x 663 x 290	542 x 799 x 290
Weight	Indoor	kg	10	10	10	10
	Outdoor	kg	22	22	24	31
Connection Pipe Diameter (Liquid/Gas)		mm	6.35/9.52	6.35/9.52	6.35/9.52	6.35/9.52
Drain Hose Diameter (I.D./O.D.)		mm	13.8/15.0 to 16.8	13.8/15.0 to 16.8	13.8/15.0 to 16.8	13.8/15.0 to 16.8
Max. Pipe Length (Pre-Charge)		m	20 (15)	20 (15)	20 (15)	20 (15)
Max. Height Difference		m	15	15	15	15
Operating Range	Cooling	°CDB	-10 to 46			
	Heating		-15 to 24			
Refrigerant	Type (Global Warming Potential)		R32 (675)	R32 (675)	R32 (675)	R32 (675)
	Charge	kg (CO2eq-T)	0.6 (0.405)	0.6 (0.405)	0.7 (0.473)	0.85 (0.574)



ECO Series Lineup Specifications



Compact Cassette

Model name	Indoor unit		AUXG09KVLA	AUXG12KVLA	AUXG14KVLA	AUXG18KVLA	AUXG22KVLA	AUXG24KVLA	
	Outdoor unit		AOHG09KATA	AOHG12KATA	AOHG14KATA	AOHG18KATA	AOHG22KATA	AOHG24KATA	
Power Source			Single phase, ~230 V, 50 Hz						
Capacity	Cooling	kW	2.5 (0.9-2.7)	3.5 (0.9-3.7)	4.3 (0.9-4.5)	5.2 (0.9-5.4)	6.0 (0.9-6.3)	6.8 (0.9-7.4)	
	Heating		3.2 (0.9-3.9)	4.1 (0.9-4.4)	5.0 (0.9-5.3)	6.0 (0.9-6.3)	7.0 (0.9-7.4)	7.5 (0.9-8.6)	
Input Power	Cooling/Heating	kW	0.68/0.88	1.09/1.17	1.37/1.42	1.69/1.72	1.95/2.00	2.26/2.08	
EER	Cooling		W/W	3.68	3.21	3.14	3.08	3.08	3.01
COP	Heating	3.64		3.50	3.52	3.49	3.50	3.61	
Pdesign	Cooling/Heating (-10°C)	kW	2.5/2.3	3.5/2.8	4.3/3.2	5.2/3.8	6.0/4.4	6.8/5.4	
SEER	Cooling		W/W	6.2	6.1	6.1	6.1	6.1	5.9
SCOP	Heating	4.0		4.0	4.0	3.9	3.9	3.8	
Energy Efficiency Class	Cooling	A++		A++		A++		A++	
	Heating	A+		A+		A		A	
Max. Operating Current	Cooling/Heating	A	6.9/6.9	7.7/7.7	9.2/9.2	10.1/10.1	11.6/11.6	12.6/12.6	
Annual Energy Consumption	Cooling		kWh/a	141	201	247	298	344	403
	Heating	804		979	1,120	1,362	1,578	1,988	
Moisture Removal		l/h	0.6	1.2	1.5	2.2	2.6	2.7	
Sound Pressure Level	Indoor (Cooling)		H/M/L/Q	33/31/29/27	37/34/30/27	38/34/30/27	38/34/30/26	44/42/36/30	49/44/36/30
	Indoor (Heating)	H/M/L/Q		34/32/29/27	37/34/31/29	43/38/34/30	43/38/34/30	45/43/40/33	49/45/40/33
	Outdoor (Cooling/Heating)	High	47/48	49/50	50/51	51/52	52/53	54/55	
Sound Power Level	Indoor (Cooling/Heating)		High	46/47	49/49	50/55	50/55	56/57	59/61
	Outdoor (Cooling/Heating)	High		60/60	62/62	63/63	63/64	64/65	66/67
Airflow Rate	Indoor/Outdoor (Cooling)		High	540/1,610	600/1,630	680/1,670	680/1,710	830/2,240	930/2,885
	Indoor/Outdoor (Heating)	High		540/1,550	600/1,410	800/1,580	800/1,840	860/2,240	930/2,350
Net Dimensions	Indoor	mm	245 × 570 × 570	245 × 570 × 570	245 × 570 × 570	245 × 570 × 570	245 × 570 × 570	245 × 570 × 570	
H × W × D	Outdoor		541 × 663 × 290	541 × 663 × 290	542 × 799 × 290	542 × 799 × 290	632 × 799 × 290	632 × 799 × 290	
Weight	Indoor	kg	15	15	15	15	16	16	
	Outdoor		23	25	32	33	36	38	
Connection Pipe Diameter (Liquid/Gas)		mm	6.35/9.52	6.35/9.52	6.35/9.52	6.35/12.70	6.35/12.70	6.35/12.70	
Drain port Diameter (I.D./O.D.)			25/32	25/32	25/32	25/32	25/32	25/32	
Max. Pipe Length (Pre-Charge)		m	15 (15)	15 (15)	20 (15)	20 (15)	25 (15)	25 (20)	
Max. Height Difference			15	15	15	15	20	20	
Operating Range	Cooling	°CDB	-10 to 46	-10 to 46	-10 to 46	-10 to 46	-10 to 46	-10 to 46	
	Heating		-15 to 24	-15 to 24	-15 to 24	-15 to 24	-15 to 24	-15 to 24	
Refrigerant	Type (Global Warming Potential)	R32 (675)		R32 (675)		R32 (675)		R32 (675)	
	Charge	kg (CO2eq-T)		0.6 (0.405)		0.7 (0.473)		0.85 (0.574)	
	Model name	UTG-UFGF-W		UTG-UFGF-W		UTG-UFGF-W		UTG-UFGF-W	
Cassette Grille	Dimensions (H × W × D)	mm	49 × 620 × 620	49 × 620 × 620	49 × 620 × 620	49 × 620 × 620	49 × 620 × 620	49 × 620 × 620	
	Weight		kg	2.3	2.3	2.3	2.3	2.3	

Circular Cassette



Model name	Indoor unit		AUXG18KRLB	AUXG22KRLB	AUXG24KRLB	AUXG30KRLB	AUXG36KRLB	AUXG45KRLB	AUXG54KRLB	AUXG36KRLB	AUXG45KRLB	AUXG54KRLB		
	Outdoor unit		AOHG18KATA	AOHG22KATA	AOHG24KATA	AOHG30KATA	AOHG36KATA	AOHG45KATA	AOHG54KATA	AOHG36KATA	AOHG45KATA	AOHG54KATA		
Power Source			Single phase, ~230 V, 50 Hz									3-phase, ~400 V, 50 Hz		
Capacity	Cooling	kW	5.2 (0.9-5.4)	6.0 (0.9-6.3)	6.8 (0.9-7.4)	8.5 (2.8-9.6)	9.5 (2.8-10.6)	12.1 (4.0-12.6)	13.4 (4.5-13.8)	9.5 (2.8-10.6)	12.1 (4.0-12.6)	13.4 (4.5-13.8)		
	Heating		6.0 (0.9-6.3)	7.0 (0.9-7.4)	7.5 (0.9-8.6)	10.0 (2.7-10.8)	10.8 (2.7-12.5)	13.5 (4.2-15.0)	15.5 (4.7-16.0)	10.8 (2.7-12.5)	13.5 (4.2-15.0)	15.5 (4.7-16.0)		
Input Power	Cooling/Heating	kW	1.60/1.66	1.85/1.93	2.12/1.97	2.56/2.64	3.06/2.58	4.32/3.77	4.87/4.86	3.06/2.58	4.32/3.77	4.87/4.86		
EER	Cooling		W/W	3.25	3.24	3.21	3.32	3.10	2.80	2.75	3.10	2.80	2.75	
COP	Heating	3.61		3.63	3.81	3.79	4.19	3.58	3.19	4.19	3.58	3.19		
Pdesign	Cooling/Heating (-10°C)	kW	5.2/3.8	6.0/4.4	6.8/5.4	8.5/8.0	9.5/8.7	-	-	9.5/8.7	-	-		
SEER	Cooling		W/W	6.2	6.2	6.1	6.1	6.1	-	-	6.1	-	-	
SCOP	Heating	4.1		4.1	4.0	4.0	4.0	-	-	4.0	-	-		
Energy Efficiency Class	Cooling	A++		A++		A++		A++		A++				
	Heating	A+		A+		A+		A+		A+				
Max. Operating Current	Cooling/Heating	A	10.1/10.1	11.6/11.6	12.6/12.6	22.5/22.5	22.5/22.5	28.1/28.1	28.1/28.1	10.5/10.5	13.6/13.6	13.6/13.6		
Annual Energy Consumption	Cooling		kWh/a	293	338	390	488	545	-	-	545	-	-	
	Heating	1,297		1,502	1,887	2,794	3,044	-	-	3,044	-	-		
Moisture Removal		l/h	1.5	2.2	2.7	2.5	3.3	4.5	5.0	3.3	4.5	5.0		
Sound Pressure Level	Indoor (Cooling)		H/M/L/Q	33/32/31/28	33/32/31/28	35/33/32/29	40/38/36/33	44/41/38/34	46/42/39/35	47/43/40/36	44/41/38/34	46/42/39/35	47/43/40/36	
	Indoor (Heating)	H/M/L/Q		33/32/31/28	33/32/31/28	35/33/32/29	40/38/36/33	44/41/38/34	46/42/39/35	47/43/40/36	44/41/38/34	46/42/39/35	47/43/40/36	
	Outdoor (Cooling/Heating)	High	51/52	52/53	54/55	53/55	55/55	58/59	58/61	55/55	60/60	61/61		
Sound Power Level	Indoor (Cooling/Heating)		High	47/47	49/49	49/49	54/54	58/58	60/60	61/61	58/58	-	-	
	Outdoor (Cooling/Heating)	High		63/64	64/65	66/67	68/69	70/70	72/73	74/75	70/70	72/73	74/75	
Airflow Rate	Indoor/Outdoor (Cooling)		High	1,050/1,710	1,050/2,240	1,150/2,885	1,600/3,750	1,870/3,750	2,000/4,450	2,100/4,450	1,870/3,750	2,000/4,450	2,100/4,450	
	Indoor/Outdoor (Heating)	High		1,050/1,840	1,050/2,240	1,150/2,350	1,600/3,750	1,870/3,750	2,000/4,450	2,100/4,780	1,870/3,750	2,000/4,450	2,100/4,780	
Net Dimensions	Indoor	mm	246 × 840 × 840	246 × 840 × 840	246 × 840 × 840	288 × 840 × 840	288 × 840 × 840	288 × 840 × 840	288 × 840 × 840	288 × 840 × 840	288 × 840 × 840	288 × 840 × 840		
H × W × D	Outdoor		542 × 799 × 290	632 × 799 × 290	632 × 799 × 290	632 × 799 × 290	632 × 799 × 290	998 × 940 × 320	998 × 940 × 320	998 × 940 × 320	998 × 940 × 320	998 × 940 × 320		
Weight	Indoor	kg	23	23	24	29	29	29	29	29	29	29		
	Outdoor		33	36	38	52	52	61	63	53	62	63		
Connection Pipe Diameter (Liquid/Gas)		mm	6.35/12.70	6.35/12.70	6.35/12.70	9.52/15.88	9.52/15.88	9.52/15.88	9.52/15.88	9.52/15.88	9.52/15.88	9.52/15.88		
Drain port Diameter (I.D./O.D.)			25/32	25/32	25/32	25/32	25/32	25/32	25/32	25/32	25/32	25/32		
Max. Pipe Length (Pre-Charge)		m	20 (15)	25 (15)	25 (20)	30 (30)	30 (30)	30 (30)	30 (30)	30 (30)	30 (30)	30 (30)		
Max. Height Difference			15	20	20	30	30	30	30	30	30	30		
Operating Range	Cooling	°CDB	-10 to 46	-10 to 46	-10 to 46	-10 to 46	-10 to 46	-10 to 46	-10 to 46	-10 to 46	-10 to 46	-10 to 46		
	Heating		-15 to 24	-15 to 24	-15 to 24	-15 to 24	-15 to 24	-15 to 24	-15 to 24	-15 to 24	-15 to 24	-15 to 24		
Refrigerant	Type (Global Warming Potential)	R32 (675)		R32 (675)		R32 (675)		R32 (675)		R32 (675)				
	Charge	kg (CO2eq-T)		1.1 (0.743)		1.25 (0.844)		1.90 (1.283)		2.4 (1.620)				
	Model name	UTG-UKGA-W		UTG-UKGA-W		UTG-UKGA-W		UTG-UKGA-W		UTG-UKGA-W				
Cassette Grille	Dimensions (H × W × D)	mm	53 × 950 × 950	53 × 950 × 950	53 × 950 × 950	53 × 950 × 950	53 × 950 × 950	53 × 950 × 950	53 × 950 × 950	53 × 950 × 950	53 × 950 × 950			
	Weight		kg	6.0	6.0	6.0	6.0	6.0	6.0	6.0	6.0	6.0		

Slim Duct



Table with columns: Model name, Indoor unit, Outdoor unit, ARXG09KLLAP, ARXG12KLLAP, ARXG14KLLAP, ARXG18KLLAP. Rows include Capacity, Input Power, EER, COP, Pdesign, SEER, SCOP, Energy Efficiency Class, Max. Operating Current, Annual Energy Consumption, Moisture Removal, Sound Pressure Level, Sound Power Level, Airflow Rate, Static pressure range, Net Dimensions, Weight, Connection Pipe Diameter, Drain port Diameter, Max. Pipe Length, Max. Height Difference, Operating Range, Refrigerant.

Medium Static Pressure Duct (Standard)



Table with columns: Model name, Indoor unit, Outdoor unit, ARXG22KMLB, ARXG24KMLA, ARXG30KMLA, ARXG36KMLA, ARXG45KMLA, ARXG36KQTA, ARXG45KQTA. Rows include Capacity, Input Power, EER, COP, Pdesign, SEER, SCOP, Energy Efficiency Class, Max. Operating Current, Annual Energy Consumption, Moisture Removal, Sound Pressure Level, Sound Power Level, Airflow Rate, Static pressure range, Net Dimensions, Weight, Connection Pipe Diameter, Drain port Diameter, Max. Pipe Length, Max. Height Difference, Operating Range, Refrigerant.

Medium Static Pressure Duct (High-Efficiency & Comfort)

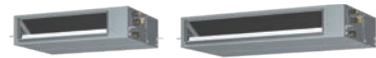





















































Table with columns: Model name, Indoor unit, Outdoor unit, ARXH22KMTAP, ARXH24KMTAP, ARXH30KMTAP, ARXH36KMTAP, ARXH45KMTAP, ARXH36KQTA, ARXH45KQTA. Rows include Capacity, Input Power, EER, COP, Pdesign, SEER, SCOP, Energy Efficiency Class, Max. Operating Current, Annual Energy Consumption, Moisture Removal, Sound Pressure Level, Sound Power Level, Airflow Rate, Static pressure range, Net Dimensions, Weight, Connection Pipe Diameter, Drain Hose Diameter, Max. Pipe Length, Max. Height Difference, Operating Range, Refrigerant.

Ceiling



Table with columns: Model name, Indoor unit, Outdoor unit, ABHG18KRTA, ABHG22KRTA, ABHG24KRTA, ABHG30KRTA, ABHG36KRTA, ABHG45KRTA, ABHG36KQTA, ABHG45KQTA. Rows include Capacity, Input Power, EER, COP, Pdesign, SEER, SCOP, Energy Efficiency Class, Max. Operating Current, Annual Energy Consumption, Moisture Removal, Sound Pressure Level, Sound Power Level, Airflow Rate, Net Dimensions, Weight, Connection Pipe Diameter, Drain port Diameter, Max. Pipe Length, Max. Height Difference, Operating Range, Refrigerant.

Feature Summary

Type	Wall-mounted type				Wall-mounted type			
Series	Designer Series		Standard Series		Standard Series		ECO Series	
Model name	 ASHG07/09/12/14KGTF, ASHG07/09/12/14KGTE	 ASHG07/09/12/14KETF ASHG07/09/12/14KETF-B, ASHG07/09/12/14KETE ASHG07/09/12/14KETE-B	 ASHG07/09/12/14KMCF, ASHG07/09/12/14KMCE	 ASHG18/24KMTE	 ASHH30/36KMTB	 ASHG07/09/12KPCE	 ASHG18/24KLCA	
								
Energy-Saving Features	 Save Occupancy sensor	●				●		
	 Occupancy sensor control							
	 Economy operation	●	●	●	●	●	●	
	 Setting temperature range limitation	○	○	○	○	○		
	 Set temperature auto return	○	○	○	○	○		
Features for Comfort	 Power diffuser							
	 Powerful operation	●	●	●	●	●	●	
	 10°C Heat	●	●	●	●	●		
	 Outdoor unit low noise operation	●	●	●	●	●		
	 Auto changeover	●	●	●	●	●	●	
	 UP/DOWN swing louver	●	●	●			●	
	 Double swing automatic				●	●		
	 Automatic fan speed	●	●	●	●	●	●	
	 Auto restart	●	●	●	●	●	●	
	 Connectable fresh air duct							
	 Fresh air intake							
	 Connectable distributing duct							
	 Individual airflow direction control							
	Convenience Features	 Auto-off timer	○	○	○	○	○	
		 Sleep timer	●	●	●	●	●	●
 Program timer		●	●	●	●	●	●	
 Weekly timer		●	●	○	●	●		
 Weekly & Temperature setback timer		○	○	○	○	○		
 Filter sign		●	●	●	●	●	●	
 External error output		○	○	○	○	○		
 External ON/OFF input		○	○	○	○	○		
 Wireless LAN control		● (KGTf) ○ (KGTE)	● (KETf, KETf-B) ○ (KETE, KETE-B)	● (KMCF) ○ (KMCE)	○	○	○	
 Multi system control						○		
Clean Features	 Special cooling					●		
	 Ion deodorization filter	●	●	●	●	●		
	 Apple-catechin filter	●	●	●	●	●		
	 Long-life filter							
	 Washable panel	●	●	●	●	●	●	
Installation Support	 Silver Ion Filter	○	○	○	○	○	○	
	 Automatic airflow adjustment							
	 Drain pump as standard							
	 Blue fin					●		
	 Refrigerant cycle monitor					○		

*1 For details of Multi System Control function, refer to C-011. *2 Wired remote controller (UTY-RNRGZ5) is required to use Special Cooling function.

○: Optional function

Feature Summary

Type	Cassette		Duct			Duct				Floor	Ceiling
Series	Compact 4-way Flow Series	Circular Flow Series	Slim (With drain pump)	Medium Static Pressure (High-Efficiency & Comfort)	Medium Static Pressure (Compact size)	Medium Static Pressure (Standard)	High Static Pressure		Big		
Model name	AUXG 09/12/14/18/22/24 KVLA	AUXG 18/22/24/30/36/45/54 KRLB	ARXG 09/12/14/18 KLLAP	ARXH 22/24/30/36/45/54 KMTAP	ARXG 12/14/18/22/24/30/36/45/54 KHTAP	ARXG22KMLB ARXG24/30/36/45KMLA	ARXG45/54KHTB	ARHG60LHTA	ARHG72/90LHTA	AGHG09/12/14KVCA	ABHG 18/22/24/30/36/45/54 KRTA
Energy-Saving Features	Save Occupancy sensor										
	Occupancy sensor control		○								
	Economy operation	●	●	●	○	●	●	●	●	●	●
	Setting temperature range limitation	○	●	○	○	●	○	○	○	●	●
	Set temperature auto return	●	●	●	○	●	○	○	○	○	●
Features for Comfort	Power diffuser										
	Powerful operation									●	
	10°C Heat	●	○	○	○	○	○	○	○	○	○
	Outdoor unit low noise operation		○ (45/54)			○ (45/54)	○ (45) (36/LMLA)		○	○	○
	Auto changeover	●	●	●	●	●	●	●	●	●	●
	UP/DOWN swing louver	●	●	○						●	●
	Double swing automatic										
	Automatic fan speed	●	●	●	●	●	●	●	●	●	●
	Auto restart	●	●	●	●	●	●	●	●	●	●
	Connectable fresh air duct		●		●	●	●				●
	Fresh air intake	○	○	○	○	○	○	○	○	○	○
	Connectable distributing duct		●				●				
	Individual airflow direction control		●								
Convenience Features	Auto-off timer	●	●	●	●	●	●	○	●	○	●
	Sleep timer	●	○	○	○	○	○	○	○	○	○
	Program timer	●	○	○	○	○	○	○	○	○	○
	Weekly timer	●	●	●	○	●	●		●	●	●
	Weekly & Temperature setback timer	○		●			●	●			
	Filter sign	●	●	●	●	●	●	●	●	●	●
	External error output		○		●	○		○	○	○	○
	External ON/OFF input	●	●	●	●	●	●	○	●	○	●
	Wireless LAN control	○	○	○	○	○	○	○	○	○	○
	Multi system control										
Special cooling											
Clean Features	Ion deodorization filter									●	
	Apple-catechin filter									●	
	Long-life filter				○	○	○	○	○		
	Washable panel										
Installation Support	Silver Ion Filter	○	○	○	○	○	○	○	○	○	
	Automatic airflow adjustment				●	●			●		
	Drain pump as standard	●	●	●	●	●	○		○		○
	Blue fin		● (30/36/45/54)		● (30/36/45/54)	● (30/36/45/54)	● (30/36/45)	●	●	●	● (30/36/45/54)
	Refrigerant cycle monitor				○						

*1 For details of Multi System Control function, refer to C-011. *2 Wired remote controller (UTY-RNRGZ5) is required to use Special Cooling function.

○: Optional function



Light Commercial & Residential MULTI-SPLIT

- M-002 Multi-split Overview
- M-004 Multi-split Outdoor Units Lineup
- M-006 2-unit to 5-unit Multi-split Connectable Indoor Units
- M-007 6-unit Multi-split Connectable Indoor Units
- M-008 Simultaneous Multi-split Connectable Indoor Units
- M-040 Feature Summary



Refrigerant type R32 models

- M-010 2-unit to 5-unit Multi-split
- M-016 Simultaneous Multi-split Twin/Triple
-
- M-020 2-unit to 5-unit Multi-split Indoor Units Specifications
-
- M-024 2-unit to 5-unit Multi-split Combination Table



Refrigerant type R410A models

- 6-unit Multi-split**
- M-014 6-unit Multi-split
- Simultaneous Multi-split Type**
- M-018 Simultaneous Multi-split Twin/Triple/Double Twin
-
- M-022 6-unit Multi-split Indoor Units Specifications
-
- M-034 6-unit Multi-split Combination Table



A single outdoor unit drives multiple indoor units, offering greater flexibility in system configuration.

If you wish to keep an entire floor or two or more rooms comfortable, we recommend you choose a multi-split air conditioning system with a single outdoor unit. Choose one that meets your air conditioning requirements from the variety of models we offer. You can mix and match indoor and outdoor units as you wish to build the system that best suits your needs.

Multi-split Overview

Multi-split's space-saving outdoor unit allows for connections of up to eight indoor units for multiple rooms. Added to the lineup are models compatible with the new R32 refrigerant, offering environmentally friendly comfort in homes, offices, stores, and various other settings.



3-unit, 4-unit, 5-unit Multi-split Types



3-unit 18/24 class



4-unit 30 class
5-unit 36 class



2-unit Multi-split



14 class



18 class

2-unit to 6-unit Multi-split

Recommended for residences, offices, and other situations where multiple rooms require air conditioning. Each of the 2 to 6 connected indoor units can also be operated individually. Operation control, time scheduling for each room, and energy-saving options can be set on both individual and central remote controllers. The outdoor unit is designed to save space and is flexible enough to be installed on a balcony or underneath a waist-high window.

6-unit Multi-split



6-unit 45 class

Twin/Triple



Twin 36 class
(Single-phase/3-phase)



Twin/Triple 45/54 class
(Single-phase/3-phase)



Twin/Triple/Double Twin



72/90 class
(3-phase)

Simultaneous Multi-split Type

Suitable for a small building, the entrance hall of a small office, meeting rooms, educational facilities, and other roomy areas where multiple indoor units need to be operated simultaneously. Up to 4 indoor units can be operated simultaneously, making the system perfect for air conditioning not only offices with large spaces, but also spaces with atypical layouts.

Multi-split Outdoor Units Lineup



FUJITSU GENERAL (Euro) GmbH participates in the ECP program for AC. Check ongoing validity of certificate: www.eurovent-certification.com
*Models so marked are not ECC certified.

		Class	14	18	18	24	30	36	45		54	72	90
		Cooling rated capacity (kW)	4.0	5.0	5.4	6.8	8.0	10.0	12.5	14.0	14.0	19.0	22.0
2-unit, 3-unit, 4-unit, 5-unit Multi-split	2-unit Multi-split Up to 2 units		AOHG14KBT2	AOHG18KBT2									
	3-unit Multi-split Up to 3 units				AOHG18KBT3	AOHG24KBT3							
	4-unit Multi-split Up to 4 units						AOHG30KBT4						
	5-unit Multi-split Up to 5 units							AOHG36KBT5*1					
6-unit Multi-split	6-unit Multi-split Up to 6 units								AOHG45LBA6*				
Simultaneous Multi-split	Twin Single-phase							AOHG36KBTB	AOHG45KBTB				
	Twin 3-phase							AOHG36KRTA	AOHG45KRTA				
	Twin/Triple Single-phase										AOHG54KBTB		
	Twin/Triple 3-phase										AOHG54KRTA		
	Twin/Triple/Double Twin 3-phase											AOHG72LRLA	AOHG90LRLA

Notes: **1. 2-unit Multi-split:** Connectable indoor units are 2 units.
AOHG14KBT2: Total capacity of indoor units connected must be between 4.0 kW and 6.0 kW.
AOHG18KBT2: Total capacity of indoor units connected must be between 4.0 kW and 7.5 kW.
2. 3-unit Multi-split: Connectable indoor units are 2 to 3 units.
AOHG18KBT3: Total capacity of indoor units connected must be between 4.0 kW and 8.5 kW.
AOHG24KBT3: Total capacity of indoor units connected must be between 4.0 kW and 10.5 kW.

3. 4-unit Multi-split: Connectable indoor units are 2 to 4 units.
AOHG30KBT4: Total capacity of indoor units connected must be between 7.5 kW and 14.0 kW.
4. 5-unit Multi-split: Connectable indoor units are 2 to 5 units.
AOHG36KBT5: Total capacity of indoor units connected must be between 7.5 kW and 15.5 kW.

5. 6-unit Multi-split: Connectable indoor units are 2 to 6 units.
AOHG45LBA6: Total capacity of indoor units connected must be between 9.5 kW and 18.0 kW.

Cooling rated capacity: *1: 9.5 kW

2-unit to 5-unit Multi-split Connectable Indoor Units



Type	2-unit		3-unit		4-unit	5-unit	
Model name	AOHG14KBTA2	AOHG18KBTA2	AOHG18KBTA3	AOHG24KBTA3	AOHG30KBTA4	AOHG36KBTA5	
Multi-split Type Outdoor Unit							
Capacity (kW)	Cooling	4.0	5.0	5.4	6.8	8.0	9.5
	Heating	4.4	5.6	6.8	8.0	9.6	10.6

Indoor Unit	BTU	kW Class	2-unit	3-unit	4-unit	5-unit
NEW ASHG07/09/12/14KGT ASHG07/09/12/14KGT ASHG07/09/12/14KGT	7,000	2.0	●	●	●	●
	9,000	2.5	●	●	●	●
NEW ASHG07/09/12/14KMF ASHG07/09/12/14KMF ASHG07/09/12/14KMF	12,000	3.5	●	●	●	●
	14,000	4.0	●	●	●	●
	18,000	5.0	—	—	●	●
	22,000	6.0	—	—	●	●
	24,000	7.0	—	—	●	●
	9,000	2.5	●	●	●	●
	12,000	3.5	●	●	●	●
	14,000	4.0	—	●	●	●
	7,000	2.0	●	●	●	●
	9,000	2.5	●	●	●	●
	12,000	3.5	●	●	●	●
	14,000	4.0	—	●	●	●
	18,000	5.0	—	—	●	●
	22,000	6.0	—	—	●	●
	7,000	2.0	●	●	●	●
	9,000	2.5	●	●	●	●
	12,000	3.5	●	●	●	●
	14,000	4.0	—	●	●	●
	18,000	5.0	—	—	●	●
	7,000	2.0	●	●	●	●
	9,000	2.5	●	●	●	●
	12,000	3.5	●	●	●	●
	14,000	4.0	—	●	●	●
	18,000	5.0	—	—	●	●
NEW ARXH22KMTAP	22,000	6.0	—	—	●	●
NEW ARXG22KMLB	22,000	6.0	—	—	●	●
	18,000	5.0	—	—	●	●
	22,000	6.0	—	—	●	●

6-unit Multi-split Connectable Indoor Units



Type	6-unit	
Model name	AOHG45LBA6	
Multi-split Type Outdoor Unit		
Capacity (kW)	Cooling	12.5
	Heating	13.5

Indoor Unit	BTU	kW Class	6-unit
	7,000	2.0	●
	9,000	2.5	●
	12,000	3.5	●
	14,000	4.0	●
	18,000	5.0	●
	24,000	7.0	●
	9,000	2.5	●
	12,000	3.5	●
	14,000	4.0	●
	7,000	2.0	●
	9,000	2.5	●
	12,000	3.5	●
	14,000	4.0	●
	18,000	5.0	●
	14,000	4.0	●
	18,000	5.0	●
	7,000	2.0	●
	9,000	2.5	●
	12,000	3.5	●
	14,000	4.0	●
	18,000	5.0	●
	7,000	2.0	●
	9,000	2.5	●
	12,000	3.5	●
	14,000	4.0	●
	18,000	5.0	●

Simultaneous Multi-split Connectable Indoor Units



Type	4HP		5HP		6HP	
Model name	AOHG36KBTB	AOHG36KRTA	AOHG45KBTB	AOHG45KRTA	AOHG54KBTB	AOHG54KRTA
Simultaneous Multi-split Type Outdoor Unit						
Capacity (kW)	Cooling	9.5	12.1	13.4	13.4	
	Heating	10.8	13.5	15.5	15.5	

Indoor Unit	BTU	kW Class	Twin			Triple
			● × 2	● × 2	● × 2	● × 3
 AUHG18/22/24KVLA	18,000	5.0	● × 2	-	-	● × 3
	22,000	6.5	-	● × 2	-	-
	24,000	7.0	-	-	● × 2	-
 ARHG18KLLAP	18,000	5.0	● × 2	-	-	● × 3
	22,000	6.5	-	● × 2	-	-
	24,000	7.0	-	-	● × 2	-
 ARXG22KMLB ARXG24KMLA	22,000	6.5	-	● × 2	-	-
	24,000	7.0	-	-	● × 2	-
	Separation tube			UTP-SX236A (18/22/24)		

Note : Please be aware that 2-wired group control is not possible with Simultaneous Multi-split.



Type	8HP		10HP	
Model name	AOHG72LRLA		AOHG90LRLA	
Simultaneous Multi-split Outdoor Unit				
Capacity (kW)	Cooling	19.0	22.0	
	Heating	22.4	27.0	

Indoor Unit	BTU	kW Class	Twin	Triple	Double Twin	Twin	Triple	Double Twin
			-	● × 3	-	● × 2	-	-
 AUHG18/22/24LV	18,000	5.0	-	-	● × 4	-	-	-
	22,000	6.5	-	-	-	-	-	● × 4
	24,000	7.0	-	● × 3	-	-	-	-
 AUHG30/36/45LR	30,000	8.8	-	-	-	-	● × 3	-
	36,000	10.6	● × 2	-	-	-	-	-
	45,000	12.5	-	-	-	● × 2	-	-
 ARHG18LLTB	18,000	5.0	-	-	● × 4	-	-	-
	22,000	6.5	-	-	-	-	-	● × 4
	24,000	7.0	-	● × 3	-	-	-	-
 ARHG22/24/30/36/45LM	30,000	8.8	-	-	-	-	● × 3	-
	36,000	10.6	● × 2	-	-	-	-	-
	45,000	12.5	-	-	-	● × 2	-	-
	18,000	5.0	-	-	● × 4	-	-	-
 ABHG18/22/24LV	22,000	6.5	-	-	-	-	-	● × 4
	24,000	7.0	-	● × 3	-	-	-	-
	30,000	8.8	-	-	-	-	● × 3	-
 ABHG30/36/45LR	36,000	10.6	● × 2	-	-	-	-	-
	45,000	12.5	-	-	-	● × 2	-	-
	Separation tube			UTP-SX272A × 1	UTP-SX372A × 1	UTP-SX272A × 1, UTP-SX236A × 2	UTP-SX272A × 1	UTP-SX372A × 1

2-unit,
3-unit,
4-unit,
5-unit,
Multi-split



High energy saving

With the adoption of a high-efficiency DC twin-rotary compressor, all models achieved an energy efficiency scale of A+++ for cooling and A++ for heating.

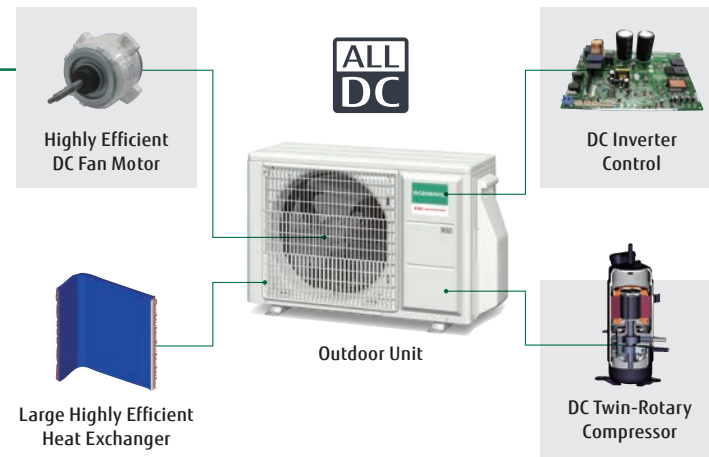

R32 refrigerant model

In addition to its high energy efficiency, the R32 refrigerant has a larger volumetric capacity than the R410A refrigerant, which means the R32 refrigerant models require less refrigerant charge than the R410A models.

	Pre-charge refrigerant amount (kg)	
	R32	R410A
2-unit 14 class	0.9	1.25
2-unit 18 class	1.02	1.30
3-unit 18 class	1.8	2.2
3-unit 24 class	1.8	2.2
4-unit 30 class	2.2	3.3
5-unit 36 class	2.5	4.0

Quiet operation

The sound power level is reduced by up to 7 dB compared to the current R410 models.

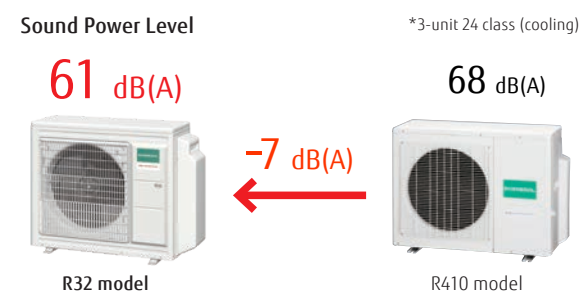

Space-saving installation

Multiple indoor units can be connected to 1 outdoor unit by long piping as well. Unlike a single type, the outdoor unit can be installed in the most space-saving location.

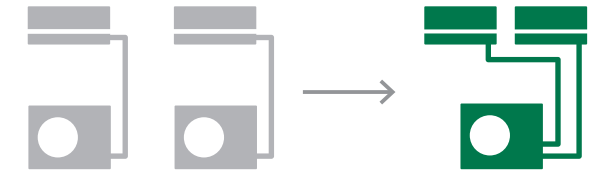

Compact design

Unlike a single type, the outdoor unit can be installed in the most space-saving location.

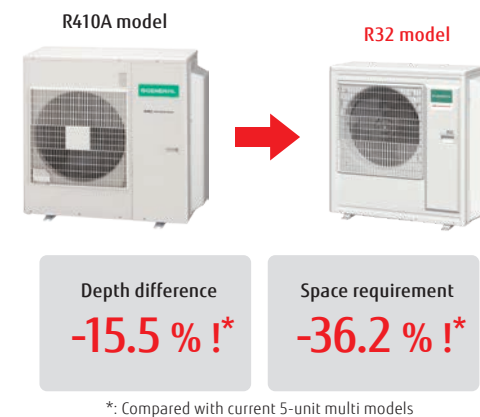

*: Compared with current 5-unit multi models

Easy evacuation

All connected pipes and indoor units can be evacuated quickly via our centralized valve method. Requires evacuation only once.

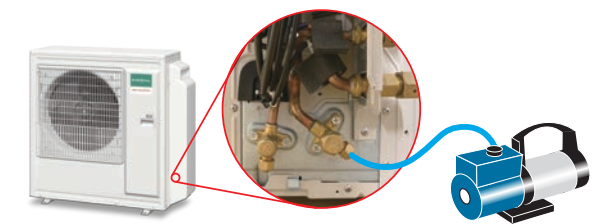

Wide range of indoor units with various models

We offer 41 models in 5 types in a capacity range from 2.0 kW to 6.0 kW. Wide range of requirements can be realized from private homes through to large shops and hotels

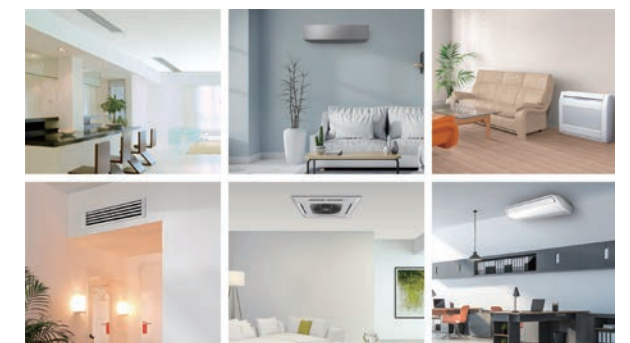

Models equipped with the New R32 Refrigerant

Wall-mounted type with sophisticated design



Middle and small capacity models are available. This makes installation easier in small spaces.



2-unit: AOHG14KBTA2 / AOHG18KBTA2
 3-unit: AOHG18KBTA3 / AOHG24KBTA3
 4-unit: AOHG30KBTA4
 5-unit: AOHG36KBTA5



Specifications (2-unit)

Model name		AOHG14KBTA2		AOHG18KBTA2	
Power Source		Single phase, ~230 V, 50 Hz			
Rated Capacity (Min. - Max.)	Cooling	4.0 (1.4-4.6)		5.0 (1.7-5.8)	
	Heating	4.4 (1.1-5.5)		5.6 (1.8-6.6)	
EER	Cooling	4.12		4.03	
	Heating	4.63		4.59	
COP	Cooling	4.7		4.7	
	Heating	4.9		5.0	
Sound Pressure Level (High)	Cooling	60		60	
	Heating	62		62	
Airflow Rate	Cooling/Heating	1,670/1,670		1,960/2,020	
Net Dimensions H × W × D		mm 542 × 799 × 290		mm 632 × 799 × 290	
Weight		kg 33		kg 37	
Connection Pipe Diameter	Liquid	6.35 × 2		6.35 × 2	
	Gas	9.52 × 2		9.52 × 2	
Max. Pipe Length		30/20		30/20	
Max. Height Difference	Between Outdoor Unit and Each Indoor Unit	m 15		m 15	
	Between Indoor Units	10		10	
Operating Range	Cooling	°CDB -10 to 46		°CDB -10 to 46	
	Heating	-15 to 24		-15 to 24	
Refrigerant	Type (Global Warming Potential)	R32 (675)		R32 (675)	
	Charge	kg (CO2eq-T) 0.9 (0.608)		kg (CO2eq-T) 1.02 (0.689)	

Specifications (3-unit)

Model name		AOHG18KBTA3		AOHG24KBTA3	
Power Source		Single phase, ~230 V, 50 Hz			
Rated Capacity (Min. - Max.)	Cooling	5.4 (1.8-7.0)		6.8 (1.8-8.5)	
	Heating	6.8 (2.0-8.0)		8.0 (2.0-9.2)	
EER	Cooling	4.78		3.90	
	Heating	4.89		4.40	
COP	Cooling	4.6		4.8	
	Heating	4.9		5.3	
Sound Pressure Level (High)	Cooling	59		61	
	Heating	61		67	
Airflow Rate	Cooling/Heating	m³/h 2,220/2,160		m³/h 2,270/2,730	
Net Dimensions H × W × D		mm 716 × 820 × 315		mm 716 × 820 × 315	
Weight		kg 46		kg 46	
Connection Pipe Diameter	Liquid	6.35 × 3		6.35 × 3	
	Gas	9.52 × 3		9.52 × 2, 12.70 × 1 adapter [12.70 → 9.52] × 1	
Max. Pipe Length		50/25		50/25	
Max. Height Difference	Between Outdoor Unit and Each Indoor Unit	m 15		m 15	
	Between Indoor Units	10		10	
Operating Range	Cooling	°CDB -10 to 46		°CDB -10 to 46	
	Heating	-15 to 24		-15 to 24	
Refrigerant	Type (Global Warming Potential)	R32 (675)		R32 (675)	
	Charge	kg (CO2eq-T) 1.8 (1.215)		kg (CO2eq-T) 1.8 (1.215)	

Specifications (4-unit, 5-unit)

Model name		AOHG30KBTA4		AOHG36KBTA5	
Power Source		Single phase, ~230 V, 50 Hz			
Rated Capacity (Min. - Max.)	Cooling	8.0 (2.4-10.1)		9.5 (3.0-11.0)	
	Heating	9.6 (3.0-11.2)		10.6 (3.5-12.0)	
EER	Cooling	3.90		3.80	
	Heating	4.55		4.50	
COP	Cooling	5.0		5.2	
	Heating	5.4		5.5	
Sound Pressure Level (High)	Cooling	63		65	
	Heating	66		68	
Airflow Rate	Cooling/Heating	m³/h 2,400/2,950		m³/h 2,450/2,900	
Net Dimensions H × W × D		mm 884 × 820 × 315		mm 884 × 820 × 315	
Weight		kg 55		kg 59	
Connection Pipe Diameter	Liquid	6.35 × 4		6.35 × 5	
	Gas	9.52 × 2, 12.70 × 2 adapter [12.70 → 9.52] × 2		9.52 × 3, 12.70 × 2 adapter [12.70 → 9.52] × 2 adapter [9.52 → 12.70] × 1	
Max. Pipe Length*		70/25		75/25	
Max. Height Difference	Between Outdoor Unit and Each Indoor Unit	m 15		m 15	
	Between Indoor Units	10		10	
Operating Range	Cooling	°CDB -10 to 46		°CDB -10 to 46	
	Heating	-15 to 24		-15 to 24	
Refrigerant	Type (Global Warming Potential)	R32 (675)		R32 (675)	
	Charge	kg (CO2eq-T) 2.2 (1.485)		kg (CO2eq-T) 2.5 (1.688)	

*Length not applicable when floor units are connected. For details, refer to the installation manual.

Dimensions

(Unit: mm)

2-unit: AOHG14KBTA2

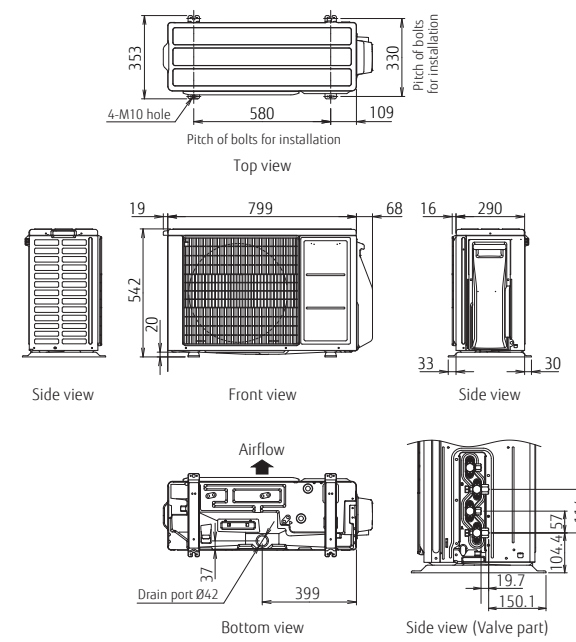

2-unit: AOHG18KBTA2

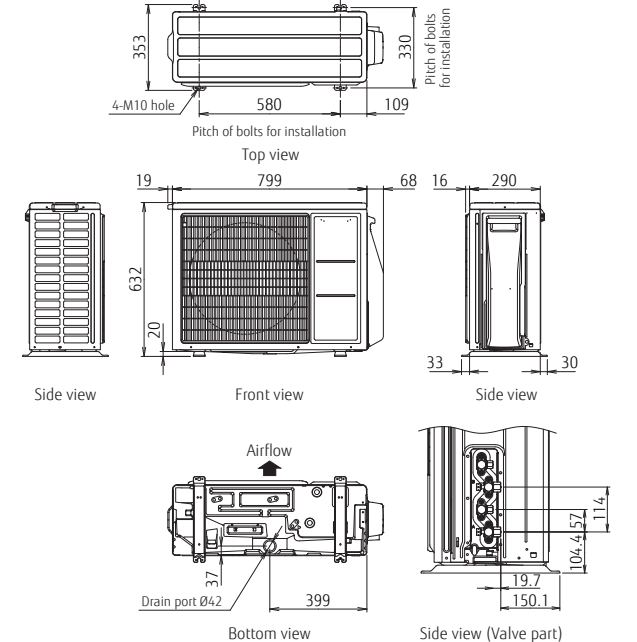

3-unit: AOHG18KBTA3 / AOHG24KBTA3

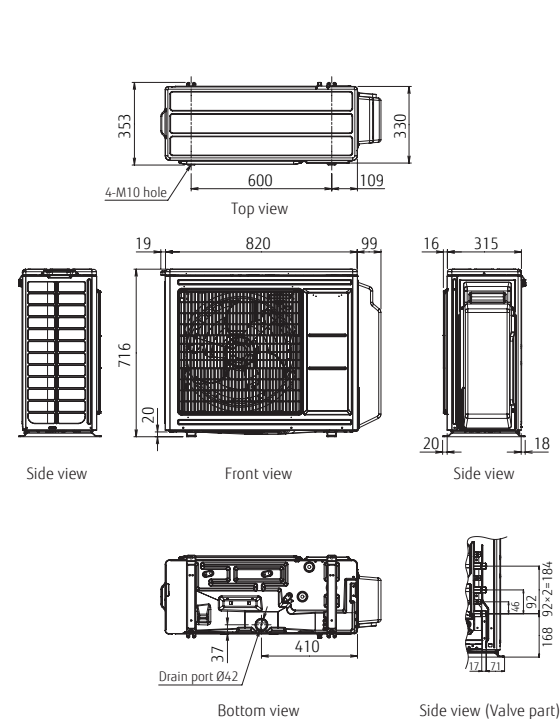

4-unit: AOHG30KBTA4
5-unit: AOHG36KBTA5

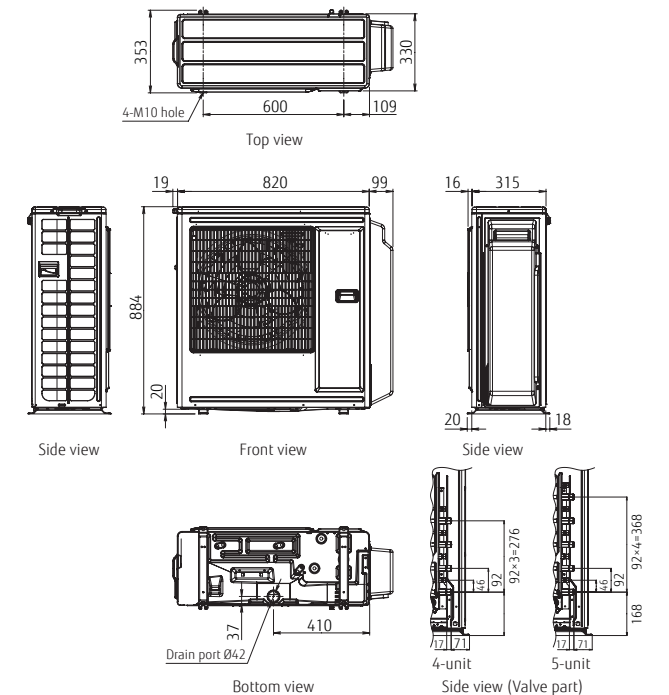

6-unit Multi-split



6-unit: AOHG45LBLA6



Specifications (5-unit, 6-unit)

Model name		AOHG45LBLA6	
Power Source		Single phase, ~230 V, 50 Hz	
Rated Capacity (Min. - Max.)	Cooling	kW	12.5 (3.5-14.0)
	Heating		13.5 (3.5-16.0)
EER	Cooling	W/W	3.50
	Heating		4.00
Sound Pressure Level (High)	Cooling	dB(A)	53
	Heating		55
Sound Power Level (High)	Cooling	-	-
	Heating		-
Airflow Rate	Cooling/Heating	m ³ /h	4,200/4,200
Net Dimensions H × W × D		mm	998 × 970 × 370
Weight		kg	94
Connection Pipe Diameter	Liquid	mm	6.35 × 6
	Gas		9.52 × 4, 12.70 × 2
Max. Pipe Length	Total/Each	m	80/25
	Between Outdoor Unit and Each Indoor Unit.		15
Max. Height Difference	Between Indoor Units.	m	10
	Operating Range		-10 to 46
Operating Range	Cooling	°CDB	-15 to 24
	Heating		-15 to 24
Refrigerant	Type (Global Warming Potential)	R410A (2,088)	
	Charge	kg (CO ₂ eq-T)	4.00 (8.352)

A wide variety of models to choose from

We offer 16 models in 4 types in a capacity range from 2.0 kW to 4.0 kW. Wide range of requirements can be realized from private homes through to large shops and hotels.

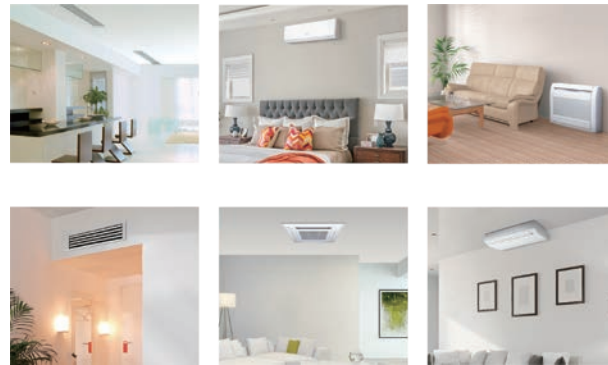

Compact design

Multiple indoor units can be connected to 1 outdoor unit by long piping as well. Unlike a single type, the outdoor unit can be installed in the most space-saving location.



Easy installation

All connected pipes and indoor units can be evacuated quickly via our centralized valve method. Requires evacuation only once.

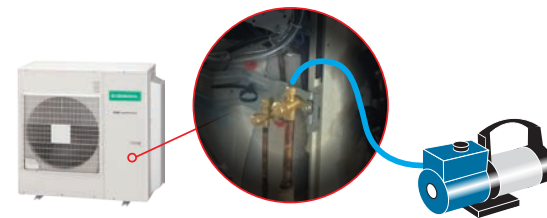

Central & Individual control

- Batched control of up to 8 indoor units. Unified setting of room temperature, airflow volume, and local control restrictions across units.
- Language can be selected from English, French, German, Greek, Italian, Portuguese, Russian, Spanish, or Turkish.
- Large backlit LED screen
- Large easy-to-see operation panel

Max. Controllable
1 multi-system
Max. Controllable
6 indoor units



Dimensions

(Unit: mm)

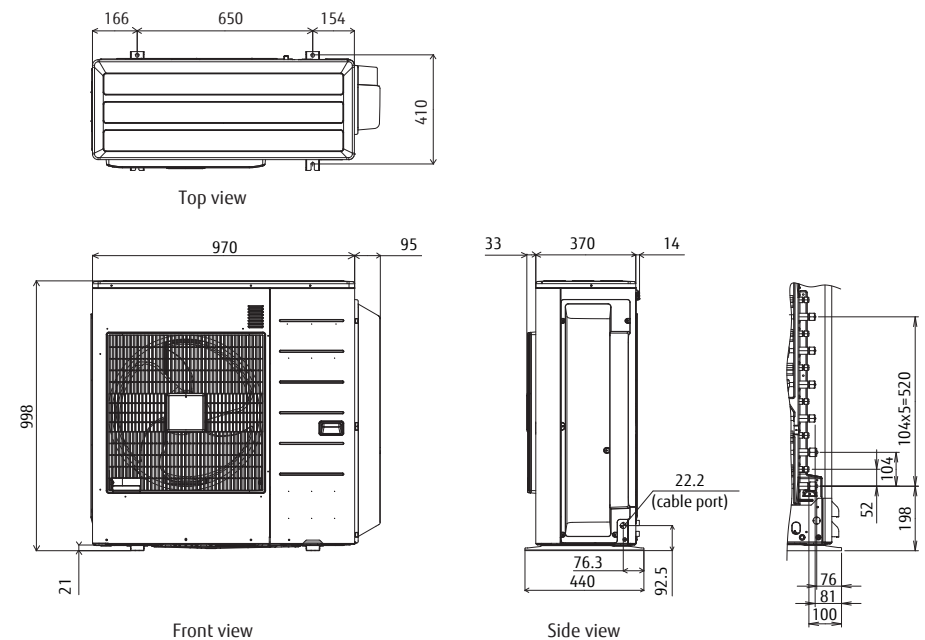

Simultaneous Multi-split Type Twin/Triple



Meets a variety of installation needs from offices to commercial spaces, with up to 3 indoor units in the same room connected to an outdoor unit.

Select indoor units according to floor layout and heat load estimated by the number of people working in the room and the direction and intensity of sunlight entering the room. Perfect airflow distribution can be achieved for optimum comfort.

Installation according to floor layout

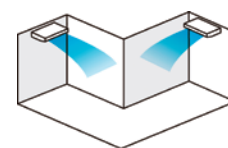

Installation according to lighting conditions

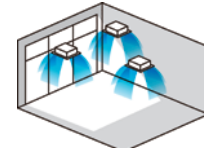

Design flexibility

Slim & Compact Design

The outdoor unit in this series is 22.7% shorter* than a twin-fan outdoor unit. The reduced height makes it easy to install in tight spaces.

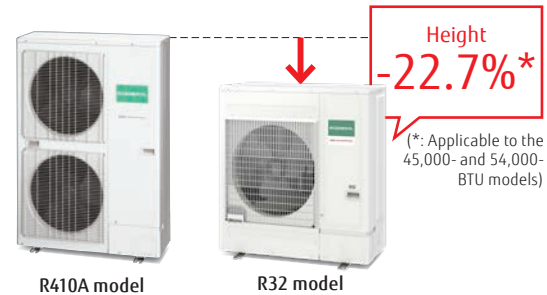

Flexible installation

Pipe length of up to 50 m and a height difference of up to 30 m can be accommodated. Multi-split systems can be installed in large residences and multi-story buildings.

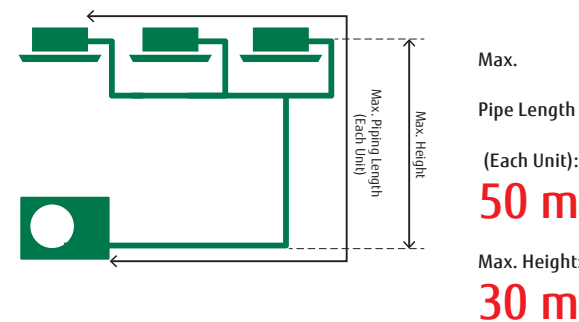

New lineup of indoor units

The indoor units, available in 6 models of 3 types, can be selected according to room size and conditions.



Note : Please be aware that 2-wired group control is not possible with Simultaneous Multi-split.

Model: AOHG36KBTB / AOHG45KBTB / AOHG54KBTB
AOHG36KRTA [3-phase] / AOHG45KRTA [3-phase] / AOHG54KRTA [3-phase]



Specifications (Indoor units/Outdoor units)

Indoor Units Model name	Compact Cassette			
	AUXG18KVLA	AUXG22KVLA	AUXG24KVLA	
Power Source	Single phase, ~230 V, 50 Hz			
Airflow Rate	Cooling H/M/L/Q Heating H/M/L/Q	680/580/490/410 800/680/580/450	830/740/600/450 860/760/700/530	930/830/600/450 930/850/700/530
Net Dimensions H × W × D	mm	245 × 570 × 570	245 × 570 × 570	245 × 570 × 570
Weight	kg	15	16	16
Cassette Grille		UTG-UFGF-W	UTG-UFGF-W	UTG-UFGF-W

Indoor Units Model name	Duct			
	ARXG18KLLAP	ARXG22KMLB	ARXG24KMLA	
Power Source	Single phase, ~230 V, 50 Hz			
Airflow Rate	Cooling H/M/L/Q Heating H/M/L/Q	940/880/820/750 1,100/910/750/580	1,100/910/750/580 1,100/910/750/580	1,100/910/750/580 1,100/910/750/580
Net Dimensions H × W × D	mm	198 × 900 × 620	270 × 1,135 × 700	270 × 1,135 × 700
Weight	kg	20	35	35

Outdoor Units Model name	AOHG36KBTB			AOHG45KBTB			AOHG54KBTB			
	AOHG36KRTA	AOHG45KRTA	AOHG54KRTA							
Capacity	Cooling	9.5	12.1	13.4	9.5	12.1	13.4	9.5	12.1	13.4
	Heating	10.8	13.5	15.5	10.8	13.5	15.5	10.8	13.5	15.5
Power Source	Single phase, ~230 V, 50 Hz						3-phase, ~400 V, 50 Hz			
Pdesign	Cooling	9.5	-	-	9.5	-	-	9.5	-	-
	Heating (-10°C)	8.7	-	-	8.7	-	-	8.7	-	-
SEER	Cooling	6.10	-	-	6.10	-	-	6.10	-	-
SCOP	Heating	4.00	-	-	4.00	-	-	4.00	-	-
Annual Energy Consumption	Cooling	545	-	-	545	-	-	545	-	-
	Heating	3,044	-	-	3,044	-	-	3,044	-	-
Energy Efficiency Class	Cooling	A++	-	-	A++	-	-	A++	-	-
	Heating	A+	-	-	A+	-	-	A+	-	-
Sound Pressure Level (High)	Cooling	55	57	57	55	57	57	55	57	57
	Heating	55	57	59	55	57	59	55	57	59
Sound Power Level (High)	Cooling	70	71	73	70	71	73	70	71	73
	Heating	70	71	73	70	71	73	70	71	73
Airflow Rate	Cooling/Heating	3,750/3,750	4,450/4,450	4,450/4,450	3,750/3,750	4,450/4,450	4,450/4,450	3,750/3,750	4,450/4,450	4,450/4,450
Net Dimensions H × W × D	mm	788 × 940 × 320	998 × 940 × 320	998 × 940 × 320	788 × 940 × 320	998 × 940 × 320	998 × 940 × 320	788 × 940 × 320	998 × 940 × 320	998 × 940 × 320
Weight	kg	52	67	67	53	67	67	53	67	67
Connection Pipe Diameter (Liquid/Gas)	mm	9.52/15.88	9.52/15.88	9.52/15.88	9.52/15.88	9.52/15.88	9.52/15.88	9.52/15.88	9.52/15.88	9.52/15.88
Max. Pipe Length (Pre-Charge)	m	50 (30)	50 (30)	50 (30)	50 (30)	50 (30)	50 (30)	50 (30)	50 (30)	50 (30)
Max. Height Difference	m	30	30	30	30	30	30	30	30	30
Operating Range	Cooling	-15 to 46	-15 to 46	-15 to 46	-15 to 46	-15 to 46	-15 to 46	-15 to 46	-15 to 46	-15 to 46
	Heating	-15 to 24	-15 to 24	-15 to 24	-15 to 24	-15 to 24	-15 to 24	-15 to 24	-15 to 24	-15 to 24
Refrigerant	Type (Global Warming Potential)	R32 (675)	R32 (675)	R32 (675)	R32 (675)	R32 (675)	R32 (675)	R32 (675)	R32 (675)	R32 (675)
	Charge	1.90 (1.283)	2.70 (1.823)	2.70 (1.823)	1.90 (1.283)	2.70 (1.823)	2.70 (1.823)	1.90 (1.283)	2.70 (1.823)	2.70 (1.823)
Separation tube		UTP-SX236A (Twin)	UTP-SX236A (Twin)	UTP-SX236A (Twin) UTP-SX354A (Triple)	UTP-SX236A (Twin)	UTP-SX236A (Twin)	UTP-SX236A (Twin)	UTP-SX236A (Twin)	UTP-SX236A (Twin)	UTP-SX236A (Twin) UTP-SX354A (Triple)

* Indoor units of different types and capacity cannot be connected.
* The above specifications apply when used with a cassette type indoor unit.

Dimensions

(Unit: mm)

AOHG36KBTB / AOHG36KRTA

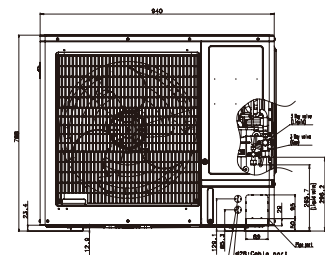
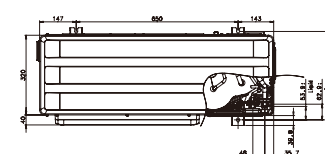

AOHG45KBTB / AOHG54KBTB AOHG45KRTA / AOHG54KRTA

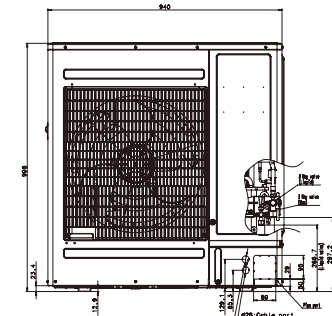
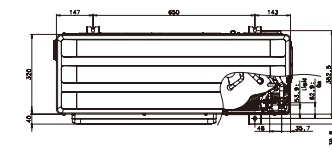

Simultaneous Multi-split Type Twin/Triple/Double Twin



Meets a variety of installation needs from an open-plan office to a retail store, with up to 4 indoor units connected to an outdoor unit.

Select indoor units according to floor layout and heat load estimated by the number of people working in the room and the direction and intensity of sunlight entering the room. Perfect airflow distribution can be achieved for optimum comfort.

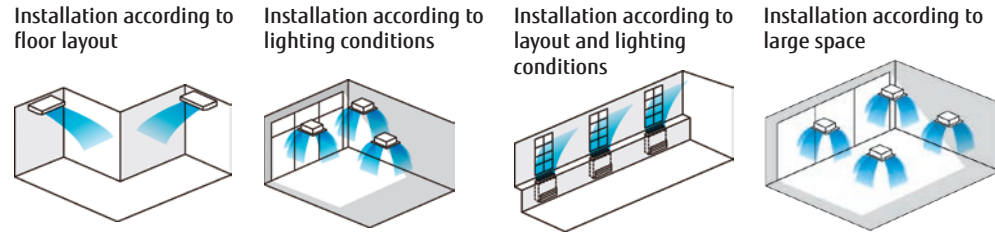

Simultaneous control

Up to 16 indoor units can be controlled simultaneously with a wired remote controller.

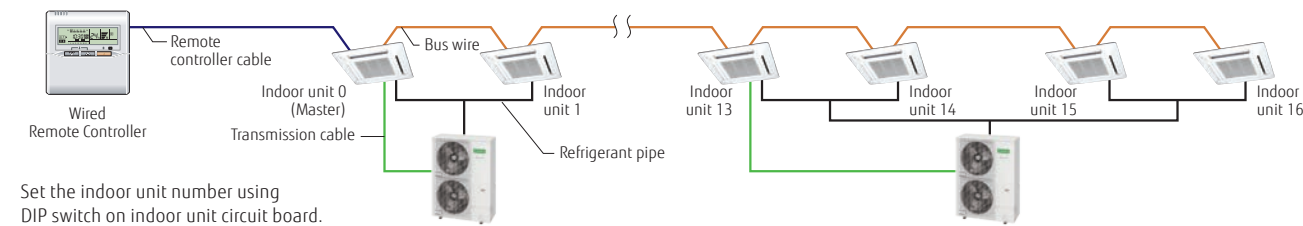

Set the indoor unit number using DIP switch on indoor unit circuit board.

*The following functions are not provided by a wireless remote controller: Timer operation, Sleep Timer operation, 10°C Heat operation

Indoor unit lineup

The indoor units, available in 18 models of 6 types, can be selected according to room size and conditions.

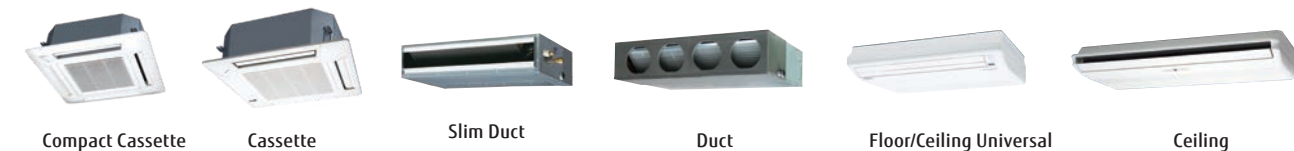

Model: AOHG72LRLA [3-phase] / AOHG90LRLA [3-phase]



Specifications (Indoor units/Outdoor units)

Indoor Units Model name		Compact Cassette, Cassette							
		AUHG18LVLB	AUHG22LVLA	AUHG24LVLA	AUHG30LRLE	AUHG36LRLE	AUHG45LRLA		
Power Source		Single phase, ~230 V, 50 Hz							
Airflow Rate	Cooling	H/M/L/Q	m ³ /h	750/610/520/410	930/830/600/450	930/830/600/450	1,600/1,400/1,270/1,150	1,800/1,400/1,270/1,150	1,900/1,640/1,460/1,250
	Heating	H/M/L/Q	m ³ /h	800/710/600/450	930/860/700/530	930/830/600/450	1,800/1,400/1,270/1,150	1,800/1,400/1,270/1,150	1,900/1,640/1,460/1,250
Net Dimensions H × W × D		mm		245 × 570 × 570	245 × 570 × 570	245 × 570 × 570	288 × 840 × 840	288 × 840 × 840	288 × 840 × 840
Weight		kg		15	16	16	26	26	26
Cassette Grille		UTG-UGGA-W							

Indoor Units Model name		Duct							
		ARHG18LLTB	ARHG22LMLA	ARHG24LMLA	ARHG30LMLE	ARHG36LMLE	ARHG45LMLA		
Power Source		Single phase, ~230 V, 50 Hz							
Airflow Rate	Cooling	H/M/L/Q	m ³ /h	940/880/820/750	1,100/910/750/580	1,100/910/750/580	1,900/1,620/1,270/980	1,900/1,620/1,270/980	2,100/1,750/1,350/1,070
	Heating	H/M/L/Q	m ³ /h	940/880/820/750	1,100/910/750/580	1,100/910/750/580	2,100/1,620/1,270/980	2,100/1,620/1,270/980	2,100/1,750/1,350/1,070
Net Dimensions H × W × D		mm		198 × 900 × 620	270 × 1135 × 700	270 × 1135 × 700	270 × 1135 × 700	270 × 1135 × 700	270 × 1135 × 700
Weight		kg		23	38	40	40	40	40 (88)

Indoor Units Model name		Floor/Ceiling, Ceiling							
		ABHG18LVTB	ABHG22LVTA	ABHG24LVTA	ABHG30LRTE	ABHG36LRTE	ABHG45LRTE		
Power Source		Single phase, ~230 V, 50 Hz							
Airflow Rate	Cooling	H/M/L/Q	m ³ /h	780/700/560/500	980/820/680/540	980/820/680/540	1,660/1,500/1,200/1,000	1,900/1,500/1,200/1,000	2,100/1,700/1,400/1,100
	Heating	H/M/L/Q	m ³ /h	780/700/560/500	980/820/680/540	980/820/680/540	1,660/1,500/1,200/1,000	1,900/1,500/1,200/1,000	2,100/1,700/1,400/1,100
Net Dimensions H × W × D		mm		199 × 990 × 655	199 × 990 × 655	199 × 990 × 655	240 × 1660 × 700	240 × 1660 × 700	240 × 1660 × 700
Weight		kg		27	27	27	46	46	46

Outdoor Units Model name				AOHG72LRLA		AOHG90LRLA	
		Capacity	Power Source	Capacity	Power Source	Capacity	Power Source
Capacity		Cooling	kW	19.0	22.0	22.0	27.0
		Heating	kW	22.4	27.0	27.0	33.0
Power Source		3-phase, ~400 V, 50 Hz					
Sound Pressure Level (High)		Cooling/Heating	dB(A)	55/55		55/57	
Airflow Rate		Cooling/Heating	m ³ /h	8,400/8,400		8,400/9,000	
Net Dimensions H × W × D		mm		1,428 × 1,080 × 480		1,428 × 1,080 × 480	
Weight		kg		163		172	
Connection Pipe Diameter (Liquid/Gas)		mm		12.7/25.4		12.7/25.4	
Max. Pipe Length (Pre-Charge)		m		100 (30)		100 (30)	
Max. Height Difference		m		30		30	
Operating Range		Cooling	°CDB	-15 to 46		-15 to 46	
		Heating	°CDB	-20 to 24		-20 to 24	
Refrigerant		Type (Global Warming Potential)		R410A (2,088)		R410A (2,088)	
		Charge	kg (CO2eq-T)	5.6 (11.693)		7.1 (14.825)	
Separation tube				UTP-SX272A × 1 (Twin)	UTP-SX372A × 1 (Triple)	UTP-SX272A × 1 (Twin)	UTP-SX254A × 2 (Double Twin)

*: That specification is not fixed yet.

• Indoor units of different types and capacity cannot be connected.
• The above specifications apply when used with a cassette type indoor unit.

Dimensions

(Unit: mm)

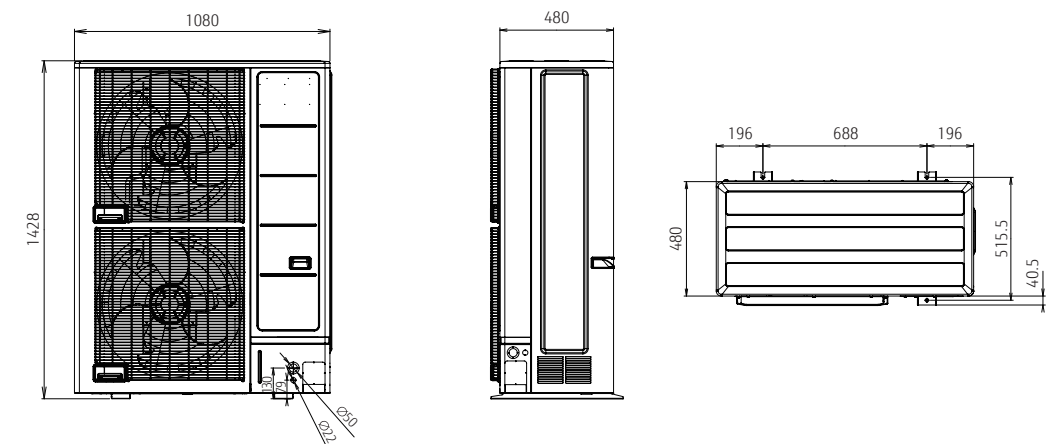

2-unit to 5-unit Multi-split Indoor Units Specifications

Wall-mounted type



Model name	Indoor unit	ASHG07KGTFF ASHG07KGTTE	ASHG09KGTFF ASHG09KGTTE	ASHG12KGTFF ASHG12KGTTE	ASHG14KGTFF ASHG14KGTTE
kW Class	kW	2.0	2.5	3.5	4.0
Power Source	Single phase, ~230 V, 50 Hz				
Sound Pressure Level	Cooling Heating	H/M/L/Q	dB(A)		
Sound Power Level	Cooling Heating	H	dB(A)		
Airflow Rate	Cooling Heating	H/M/L/Q	m³/h		
Net Dimensions	mm				
Weight	kg				
Connection Pipe Diameter	Liquid/Gas	mm			

Wall-mounted type



Model name	Indoor unit	ASHG07KETF ASHG07KETF-B ASHG07KETE ASHG07KETE-B	ASHG09KETF ASHG09KETF-B ASHG09KETE ASHG09KETE-B	ASHG12KETF ASHG12KETF-B ASHG12KETE ASHG12KETE-B	ASHG14KETF ASHG14KETF-B ASHG14KETE ASHG14KETE-B
kW Class	kW	2.0	2.5	3.5	4.0
Power Source	Single phase, ~230 V, 50 Hz				
Sound Pressure Level	Cooling Heating	H/M/L/Q	dB(A)		
Sound Power Level	Cooling Heating	H	dB(A)		
Airflow Rate	Cooling Heating	H/M/L/Q	m³/h		
Net Dimensions	mm				
Weight	kg				
Connection Pipe Diameter	Liquid/Gas	mm			

Wall-mounted type



Model name	Indoor unit	ASHG07KMCF ASHG07KMCE	ASHG09KMCF ASHG09KMCE	ASHG12KMCF ASHG12KMCE	ASHG14KMCF ASHG14KMCE
kW Class	kW	2.0	2.5	3.5	4.0
Power Source	Single phase, ~230 V, 50 Hz				
Sound Pressure Level	Cooling Heating	H/M/L/Q	dB(A)		
Sound Power Level	Cooling Heating	H	dB(A)		
Airflow Rate	Cooling Heating	H/M/L/Q	m³/h		
Net Dimensions	mm				
Weight	kg				
Connection Pipe Diameter	Liquid/Gas	mm			

Wall-mounted type



Model name	Indoor unit	ASHG18KMTE	ASHG22KMTE	ASHG24KMTE
kW Class	kW	5.0	6.0	7.0
Power Source	Single phase, ~230 V, 50 Hz			
Sound Pressure Level	Cooling Heating	H/M/L/Q	dB(A)	
Sound Power Level	Cooling Heating	H	dB(A)	
Airflow Rate	Cooling Heating	H/M/L/Q	m³/h	
Net Dimensions	mm			
Weight	kg			
Connection Pipe Diameter	Liquid/Gas	mm		

Floor



Model name	Indoor unit	AGHG09KVCA	AGHG12KVCA	AGHG14KVCA
kW Class	kW	2.5	3.5	4.0
Power Source	Single phase, ~230 V, 50 Hz			
Sound Pressure Level	Cooling Heating	H/M/L/Q	dB(A)	
Sound Power Level	Cooling Heating	H	dB(A)	
Airflow Rate	Cooling Heating	H/M/L/Q	m³/h	
Net Dimensions	mm			
Weight	kg			
Connection Pipe Diameter	Liquid/Gas	mm		

Ceiling



Model name	Indoor unit	ABHG18KRTA	ABHG22KRTA	
kW Class	kW	5.0	6.0	
Power Source	Single phase, ~230 V, 50 Hz			
Sound Pressure Level	Cooling Heating	H/M/L/Q	dB(A)	
Sound Power Level	Cooling Heating	H	dB(A)	
Airflow Rate	Cooling Heating	H/M/L/Q	m³/h	
Net Dimensions	mm			
Weight	kg			
Connection Pipe Diameter	Liquid/Gas	mm		

Compact Cassette Grid Type



Model name	Indoor unit	AUXG07KVLA	AUXG09KVLA	AUXG12KVLA	AUXG14KVLA	AUXG18KVLA	AUXG22KVLA
kW Class	kW	2.0	2.5	3.5	4.0	5.0	6.0
Power Source	Single phase, ~230 V, 50 Hz						
Sound Pressure Level	Cooling Heating	H/M/L/Q	dB(A)				
Sound Power Level	Cooling Heating	H	dB(A)				
Airflow Rate	Cooling Heating	H/M/L/Q	m³/h				
Net Dimensions	mm						
Weight	kg						
Panel	mm						
Connection Pipe Diameter	Liquid/Gas	mm					

Mini duct



Model name	Indoor unit	ARXG07KSLAP	ARXG09KSLAP	ARXG12KSLAP	ARXG14KSLAP	ARXG18KSLAP
kW Class	kW	2.0	2.5	3.5	4.0	5.0
Power Source	Single phase, ~230 V, 50 Hz					
Sound Pressure Level	Cooling Heating	H/M/L/Q	dB(A)			
Sound Power Level	Cooling Heating	H	dB(A)			
Airflow Rate	Cooling Heating	H/M/L/Q	m³/h			
Net Dimensions	mm					
Weight	kg					
Connection Pipe Diameter	Liquid/Gas	mm				
External static pressure	Pa					
Drain pump	Standard					

Slim duct

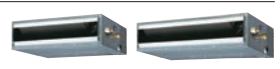

Model name	Indoor unit	ARXG07KLLAP	ARXG09KLLAP	ARXG12KLLAP	ARXG14KLLAP	ARXG18KLLAP
kW Class	kW	2.0	2.5	3.5	4.0	5.0
Power Source	Single phase, ~230 V, 50 Hz					
Sound Pressure Level	Cooling Heating	H/M/L/Q	dB(A)			
Sound Power Level	Cooling Heating	H	dB(A)			
Airflow Rate	Cooling Heating	H/M/L/Q	m³/h			
Net Dimensions	mm					
Weight	kg					
Connection Pipe Diameter	Liquid/Gas	mm				
External static pressure	Pa					
Drain pump	Standard					

Medium Static Pressure Duct

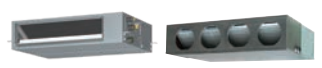

Model name	Indoor unit	ARXH22KMTAP	ARXG22KMLB	
kW Class	kW	6.0	6.0	
Power Source	Single phase, ~230 V, 50 Hz			
Sound Pressure Level	Cooling Heating	H/M/L/Q	dB(A)	
Sound Power Level	Cooling Heating	H	dB(A)	
Airflow Rate	Cooling Heating	H/M/L/Q	m³/h	
Net Dimensions	mm			
Weight	kg			
Connection Pipe Diameter	Liquid/Gas	mm		
External static pressure	Pa			
Drain pump	Standard			

6-unit Multi-split Indoor Units Specifications

Compact wall-mounted



Model name	Indoor unit		ASHG07LUCA	ASHG09LUCA	ASHG12LUCA	ASHG14LUCA	
kW Class	kW		2.0	2.5	3.5	4.0	
Power Source	Single phase, ~230 V, 50 Hz						
Sound Pressure Level	Cooling	H/M/L/Q	dB(A)	35/30/28/21	36/32/28/21	37/34/31/21	41/36/33/25
	Heating			35/30/28/21	36/32/28/21	37/34/31/21	41/36/34/27
Sound Power Level	Cooling	H	dB(A)	53	54	55	59
	Heating			53	54	55	59
Airflow Rate	Cooling	H/M/L/Q	m³/h	570/520/470/330	600/550/470/330	660/600/530/330	710/640/570/390
	Heating			570/520/470/330	600/550/470/330	660/600/530/330	710/640/590/430
Net Dimensions			mm	282 × 870 × 185	282 × 870 × 185	282 × 870 × 185	282 × 870 × 185
Weight			kg	9.5	9.5	9.5	9.5
Connection Pipe Diameter	Liquid/Gas	mm	6.35/9.52				

Wall-mounted type



Model name	Indoor unit		ASHG18LFCA	ASHG24LFCC
kW Class	kW		5.0	7.0
Power Source	Single phase, ~230 V, 50 Hz			
Sound Pressure Level	Cooling	H/M/L/Q	dB(A)	43/37/33/26
	Heating			42/37/33/25
Sound Power Level	Cooling	H	dB(A)	58
	Heating			58
Airflow Rate	Cooling	H/M/L/Q	m³/h	900/740/620/550
	Heating			900/740/620/550
Net Dimensions			mm	320 × 998 × 238
Weight			kg	14
Connection Pipe Diameter	Liquid/Gas	mm	6.35/12.70	

Compact wall-mounted



Model name	Indoor unit		ASHG07LMCA	ASHG09LMCA	ASHG12LMCA	ASHG14LMCA	
kW Class	kW		2.0	2.5	3.5	4.0	
Power Source	Single phase, ~230 V, 50 Hz						
Sound Pressure Level	Cooling	H/M/L/Q	dB(A)	36/32/29/21	37/33/29/21	40/36/30/21	42/38/33/25
	Heating			36/32/29/22	37/33/29/22	40/36/31/22	42/38/35/27
Sound Power Level	Cooling	H	dB(A)	51	52	54	56
	Heating			51	52	55	57
Airflow Rate	Cooling	H/M/L/Q	m³/h	560/500/430/310	600/520/430/310	660/560/450/310	730/600/530/360
	Heating			560/500/430/330	600/520/430/330	660/560/470/330	730/615/560/375
Net Dimensions			mm	268 × 840 × 203	268 × 840 × 203	268 × 840 × 203	268 × 840 × 203
Weight			kg	8.5	8.5	8.5	8.5
Connection Pipe Diameter	Liquid/Gas	mm	6.35/9.52				

Floor



Model name	Indoor unit		AGHG09LVCA	AGHG12LVCA	AGHG14LVCA	
kW Class	kW		2.5	3.5	4.0	
Power Source	Single phase, ~230 V, 50 Hz					
Sound Pressure Level	Cooling	H/M/L/Q	dB(A)	39/34/28/22	42/36/30/22	44/38/31/22
	Heating			39/35/30/22	42/38/32/22	44/39/33/22
Sound Power Level	Cooling	H	dB(A)	52	55	56
	Heating			52	55	56
Airflow Rate	Cooling	H/M/L/Q	m³/h	530/440/360/270	600/490/380/270	650/520/400/270
	Heating			530/460/380/270	600/510/410/270	650/540/430/270
Net Dimensions			mm	600 × 740 × 200	600 × 740 × 200	600 × 740 × 200
Weight			kg	14	14	14
Connection Pipe Diameter	Liquid/Gas	mm	6.35/9.52			

Floor ceiling



Model name	Indoor unit		ABHG14LVTA	ABHG18LVTB	
kW Class	kW		4.0	5.0	
Power Source	Single phase, ~230 V, 50 Hz				
Sound Pressure Level	Cooling	H/M/L/Q	dB(A)	36/34/33/29 (Under ceiling) 39/37/36/32 (Floor console)	41/38/34/32 (Under ceiling) 44/41/37/35 (Floor console)
	Heating			36/34/33/29 (Under ceiling) 39/37/36/32 (Floor console)	41/38/34/32 (Under ceiling) 44/41/37/35 (Floor console)
Sound Power Level	Cooling	H	dB(A)	51	55
	Heating			51	55
Airflow Rate	Cooling	H/M/L/Q	m³/h	640/590/540/480	780/700/560/500
	Heating			640/590/540/480	780/700/560/500
Net Dimensions			mm	199 × 990 × 655	
Weight			kg	27	
Connection Pipe Diameter	Liquid/Gas	mm	6.35/12.70		

Compact cassette



Model name	Indoor unit		AUHG07LVLA	AUHG09LVLA	AUHG12LVLB	AUHG14LVLB	AUHG18LVLB	
kW Class	kW		2.0	2.5	3.5	4.0	5.0	
Power Source	Single phase, ~230 V, 50 Hz							
Sound Pressure Level	Cooling	H/M/L/Q	dB(A)	33/31/29/27	33/31/29/27	37/33/31/28	40/35/32/29	42/37/33/29
	Heating			34/32/29/27	34/32/29/27	37/33/31/28	40/37/34/29	44/40/37/30
Sound Power Level	Cooling	H	dB(A)	46	46	49	52	54
	Heating			47	47	49	52	56
Airflow Rate	Cooling	H/M/L/Q	m³/h	540/490/440/390	540/490/440/390	610/530/470/410	680/580/490/410	750/610/520/410
	Heating			540/490/440/390	540/490/440/390	610/530/470/410	700/620/550/430	800/710/600/450
Net Dimensions			mm	245 × 570 × 570	245 × 570 × 570	245 × 570 × 570	245 × 570 × 570	245 × 570 × 570
Weight			kg	15	15	15	15	15
Panel			UTG-UFGD-W					
Connection Pipe Diameter	Liquid/Gas	mm	6.35/9.52	6.35/9.52	6.35/9.52	6.35/12.70	6.35/12.70	

Mini duct



Model name	Indoor unit		ARRHG07LSLAP	ARRHG09LSLAP	ARRHG12LSLAP	ARRHG14LSLAP	ARRHG18LSLAP	
kW Class	kW		2.0	2.5	3.5	4.0	5.0	
Power Source	Single phase, ~230 V, 50 Hz							
Sound Pressure Level	Cooling	H/M/L/Q	dB(A)	29/26/24/23	29/26/24/23	31/27/25/23	35/30/27/23	33/29/26/23
	Heating			29/26/24/23	29/26/24/23	31/27/25/23	35/30/27/23	33/29/26/23
Sound Power Level	Cooling	H	dB(A)	52	54	55	60	58
	Heating			53	56	57	62	59
Airflow Rate	Cooling	H/M/L/Q	m³/h	550/440/390/360	600/450/400/360	650/490/430/360	800/640/530/360	940/750/540/480
	Heating			550/440/390/360	600/450/400/360	650/490/430/360	800/640/530/360	940/750/540/480
Net Dimensions			mm	198 × 700 × 450	198 × 700 × 450	198 × 700 × 450	198 × 700 × 450	198 × 900 × 450
Weight			kg	15.5			18.5	
Connection Pipe Diameter	Liquid/Gas	mm	6.35/9.52				6.35/12.70	
External static pressure			Pa	0 to 30			0 to 50	
Drain pump	Standard							

Slim duct

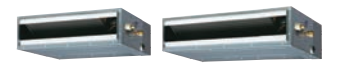

Model name	Indoor unit		ARRHG07LLTA	ARRHG09LLTA	ARRHG12LLTB	ARRHG14LLTB	ARRHG18LLTB	
kW Class	kW		2.0	2.5	3.5	4.0	5.0	
Power Source	Single phase, ~230 V, 50 Hz							
Sound Pressure Level	Cooling	H/M/L/Q	dB(A)	28/26/25/24	28/27/26/25	29/28/27/26	32/30/28/26	32/31/30/29
	Heating			28/26/25/24	28/26/25/24	29/28/27/24	33/30/28/25	33/32/31/29
Sound Power Level	Cooling	H	dB(A)	57	57	58	60	58
	Heating			57	57	58	61	59
Airflow Rate	Cooling	H/M/L/Q	m³/h	550/490/470/440	600/550/500/450	650/600/550/480	800/700/600/480	940/880/820/750
	Heating			550/490/470/440	600/550/500/450	650/600/550/480	800/700/600/480	940/880/820/750
Net Dimensions			mm	198 × 700 × 620	198 × 700 × 620	198 × 700 × 620	198 × 700 × 620	198 × 900 × 620
Weight			kg	17	19	19	19	23
Connection Pipe Diameter	Liquid/Gas	mm	6.35/9.52				6.35/12.7	6.35/12.70
External static pressure			Pa	0 to 90				
Drain pump	Standard							

2-unit Multi-split Combination Table-Cooling/Heating

2-unit Multi-split cooling

AOHG14KBTA2	Combination of Indoor Units		Cooling Operation				Seasonal Data			
			Cooling Capacity			Input Power (Min. - Max.) kW	EER	Pdesign kW	SEER	Energy efficiency class
			Unit 1 kW	Unit 2 kW	Total Capacity (Min. - Max.) kW					
2-unit connection	7	7	2.00	2.00	4.00 (1.4-4.6)	0.97 (0.25-1.20)	4.12	4.0	8.7	A+++
	7	9	1.75	2.25	4.00 (1.4-4.6)	0.97 (0.25-1.20)	4.12	4.0	8.7	A+++
	7	12	1.47	2.53	4.00 (1.4-4.6)	0.97 (0.25-1.20)	4.12	4.0	8.7	A+++
	9	9	2.00	2.00	4.00 (1.4-4.6)	0.97 (0.25-1.20)	4.12	4.0	8.7	A+++
	9	12	1.71	2.29	4.00 (1.4-4.6)	0.97 (0.25-1.20)	4.12	4.0	8.7	A+++

Notes: •7: 7000 Btu/h/9: 9000 Btu/h/12: 12000 Btu/h models
 •The above specifications apply when connected with a wall-mounted [KG] unit.
 •2 or more indoor units should be connected.
 •Cooling capacity is determined based on 27°CDB/19°CWB (indoor temperature) and 35°CDB (outdoor temperature).
 •Pipe Length: 5 m, Height difference: 0 m (Outdoor unit to Indoor unit)
 •Total capacity of indoor units connected must be between 4.0 kW and 6.0 kW.

AOHG18KBTA2	Combination of Indoor Units		Cooling Operation				Seasonal Data			
			Cooling Capacity			Input Power (Min. - Max.) kW	EER	Pdesign kW	SEER	Energy efficiency class
			Unit 1 kW	Unit 2 kW	Total Capacity (Min. - Max.) kW					
2-unit connection	7	7	2.00	2.00	4.00 (1.7-5.0)	0.92 (0.25-1.23)	4.35	4.0	8.8	A+++
	7	9	2.00	2.50	4.50 (1.7-5.7)	1.07 (0.25-1.45)	4.22	4.5	8.7	A+++
	7	12	1.84	3.16	5.00 (1.7-5.8)	1.24 (0.25-1.55)	4.03	5.0	8.6	A+++
	7	14	1.67	3.33	5.00 (1.7-5.8)	1.24 (0.25-1.55)	4.03	5.0	8.6	A+++
	9	9	2.50	2.50	5.00 (1.7-5.8)	1.24 (0.25-1.55)	4.03	5.0	8.6	A+++
	9	12	2.14	2.86	5.00 (1.7-5.8)	1.24 (0.25-1.55)	4.03	5.0	8.6	A+++
	9	14	1.96	3.04	5.00 (1.7-5.8)	1.24 (0.25-1.55)	4.03	5.0	8.6	A+++
	12	12	2.50	2.50	5.00 (1.7-5.8)	1.24 (0.25-1.55)	4.03	5.0	8.6	A+++
	12	14	2.31	2.69	5.00 (1.7-5.8)	1.24 (0.25-1.55)	4.03	5.0	8.6	A+++

Notes: •7: 7000 Btu/h/9:9000 Btu/h/12: 12000 Btu/h/14: 14000 Btu/h models
 •The above specifications apply when connected with a wall-mounted [KG] unit.
 •2 or more indoor units should be connected.
 •Cooling capacity is determined based on 27°CDB/19°CWB (indoor temperature) and 35°CDB (outdoor temperature).
 •Pipe Length: 5 m, Height difference: 0 m (Outdoor unit to Indoor unit)
 •Total capacity of indoor units connected must be between 4.0 kW and 7.5 kW.

2-unit Multi-split heating

AOHG14KBTA2	Combination of Indoor Units		Heating Operation				Seasonal Data			
			Heating Capacity			Input Power (Min. - Max.) kW	COP	Pdesign kW	SCOP	Energy efficiency class
			Unit 1 kW	Unit 2 kW	Total Capacity (Min. - Max.) kW					
2-unit connection	7	7	2.20	2.20	4.40 (1.1-5.5)	0.95 (0.25-1.65)	4.63	3.5	4.7	A++
	7	9	1.92	2.48	4.40 (1.1-5.5)	0.95 (0.25-1.65)	4.63	3.5	4.7	A++
	7	12	1.62	2.78	4.40 (1.1-5.5)	0.95 (0.25-1.65)	4.63	3.5	4.7	A++
	9	9	2.20	2.20	4.40 (1.1-5.5)	0.95 (0.25-1.65)	4.63	3.5	4.7	A++
	9	12	1.89	2.51	4.40 (1.1-5.5)	0.95 (0.25-1.65)	4.63	3.5	4.7	A++

Notes: •7: 7000 Btu/h/9: 9000 Btu/h/12: 12000 Btu/h models
 •The above specifications apply when connected with a wall-mounted [KG] unit.
 •2 or more indoor units should be connected.
 •Heating capacity is determined based on 20°CDB (indoor temperature) and 7°CDB/6°CWB (outdoor temperature).
 •Pipe Length: 5 m, Height difference: 0 m (Outdoor unit to Indoor unit)
 •Total capacity of indoor units connected must be between 4.0 kW and 6.0 kW.

AOHG18KBTA2	Combination of Indoor Units		Heating Operation				Seasonal Data			
			Heating Capacity			Input Power (Min. - Max.) kW	COP	Pdesign kW	SCOP	Energy efficiency class
			Unit 1 kW	Unit 2 kW	Total Capacity (Min. - Max.) kW					
2-unit connection	7	7	2.40	2.40	4.80 (1.7-5.6)	0.99 (0.25-1.35)	4.85	3.8	4.7	A++
	7	9	2.40	3.00	5.40 (1.7-6.4)	1.15 (0.25-1.60)	4.70	4.0	4.7	A++
	7	12	2.06	3.54	5.60 (1.7-7.0)	1.22 (0.25-1.80)	4.59	4.2	4.7	A++
	7	14	1.87	3.73	5.60 (1.7-7.0)	1.22 (0.25-1.80)	4.59	4.2	4.7	A++
	9	9	2.80	2.80	5.60 (1.7-7.0)	1.22 (0.25-1.80)	4.59	4.2	4.7	A++
	9	12	2.40	3.20	5.60 (1.7-7.0)	1.22 (0.25-1.80)	4.59	4.2	4.7	A++
	9	14	2.19	3.41	5.60 (1.7-7.0)	1.22 (0.25-1.80)	4.59	4.2	4.7	A++
	12	12	2.80	2.80	5.60 (1.7-7.0)	1.22 (0.25-1.80)	4.59	4.2	4.7	A++
	12	14	2.58	3.02	5.60 (1.7-7.0)	1.22 (0.25-1.80)	4.59	4.2	4.7	A++

Notes: •7: 7000 Btu/h/9:9000 Btu/h/12: 12000 Btu/h/14: 14000 Btu/h models
 •The above specifications apply when connected with a wall-mounted [KG] unit.
 •2 or more indoor units should be connected.
 •Heating capacity is determined based on 20°CDB (indoor temperature) and 7°CDB/6°CWB (outdoor temperature).
 •Pipe Length: 5 m, Height difference: 0 m (Outdoor unit to Indoor unit)
 •Total capacity of indoor units connected must be between 4.0 kW and 7.5 kW.

3-unit Multi-split Combination Table-Cooling/Heating

3-unit Multi-split cooling

AOHG18KBTA3	Combination of Indoor Units			Cooling Operation						Seasonal Data		
				Cooling Capacity			Input Power (Min. - Max.) kW	EER	Pdesign kW	SEER	Energy efficiency	
				Unit 1 kW	Unit 2 kW	Unit 3 kW						Total Capacity (Min. - Max.) kW
2-unit connection	7	7	-	2.00	2.00	-	4.00 (1.8-5.0)	0.86 (0.35-1.35)	4.65	4.0	8.3	A++
	7	9	-	2.00	2.50	-	4.50 (1.8-5.7)	1.03 (0.35-1.54)	4.36	4.5	8.2	A++
	7	12	-	1.99	3.41	-	5.40 (1.8-6.8)	1.41 (0.35-1.85)	3.83	5.4	8.0	A++
	7	14	-	1.80	3.60	-	5.40 (1.8-7.0)	1.41 (0.35-1.90)	3.83	5.4	8.0	A++
	9	9	-	2.50	2.50	-	5.00 (1.8-6.4)	1.23 (0.35-1.74)	4.06	5.0	8.1	A++
	9	12	-	2.31	3.09	-	5.40 (1.8-7.0)	1.41 (0.35-1.90)	3.83	5.4	8.0	A++
	9	14	-	2.11	3.29	-	5.40 (1.8-7.0)	1.41 (0.35-1.90)	3.83	5.4	8.0	A++
	12	12	-	2.70	2.70	-	5.40 (1.8-7.0)	1.41 (0.35-1.90)	3.83	5.4	8.0	A++
	12	14	-	2.49	2.91	-	5.40 (1.8-7.0)	1.41 (0.35-1.90)	3.83	5.4	8.0	A++
	14	14	-	2.70	2.70	-	5.40 (1.8-7.0)	1.41 (0.35-1.90)	3.83	5.4	8.0	A++
3-unit connection	7	7	7	1.80	1.80	1.80	5.40 (1.8-7.0)	1.13 (0.35-1.90)	4.78	5.4	8.6	A+++
	7	7	9	1.64	1.64	2.12	5.40 (1.8-7.0)	1.13 (0.35-1.90)	4.78	5.4	8.6	A+++
	7	7	12	1.45	1.45	2.50	5.40 (1.8-7.0)	1.13 (0.35-1.90)	4.78	5.4	8.6	A+++
	7	7	14	1.35	1.35	2.70	5.40 (1.8-7.0)	1.13 (0.35-1.90)	4.78	5.4	8.6	A+++
	7	9	9	1.52	1.94	1.94	5.40 (1.8-7.0)	1.13 (0.35-1.90)	4.78	5.4	8.6	A+++
	7	9	12	1.35	1.74	2.31	5.40 (1.8-7.0)	1.13 (0.35-1.90)	4.78	5.4	8.6	A+++
	7	9	14	1.26	1.62	2.52	5.40 (1.8-7.0)	1.13 (0.35-1.90)	4.78	5.4	8.6	A+++
	9	9	9	1.80	1.80	1.80	5.40 (1.8-7.0)	1.13 (0.35-1.90)	4.78	5.4	8.6	A+++
	9	9	12	1.62	1.62	2.16	5.40 (1.8-7.0)	1.13 (0.35-1.90)	4.78	5.4	8.6	A+++

AOHG24KBTA3	Combination of Indoor Units			Cooling Operation						Seasonal Data		
				Cooling Capacity			Input Power (Min. - Max.) kW	EER	Pdesign kW	SEER	Energy efficiency	
				Unit 1 kW	Unit 2 kW	Unit 3 kW						Total Capacity (Min. - Max.) kW
2-unit connection	7	7	-	2.00	2.00	-	4.00 (1.8-5.0)	0.86 (0.35-1.35)	4.65	4.0	8.3	A++
	7	9	-	2.00	2.50	-	4.50 (1.8-5.7)	1.03 (0.35-1.54)	4.36	4.5	8.2	A++
	7	12	-	2.00	3.50	-	5.50 (1.8-6.8)	1.46 (0.35-1.85)	3.77	5.5	8.0	A++
	7	14	-	2.00	4.00	-	6.00 (1.8-7.5)	1.73 (0.35-2.20)	3.48	6.0	7.6	A++
	7	18	-	1.90	4.90	-	6.80 (1.8-8.5)	2.26 (0.35-2.65)	3.01	6.8	6.9	A++
	9	9	-	2.50	2.50	-	5.00 (1.8-6.4)	1.23 (0.35-1.74)	4.06	5.0	8.1	A++
	9	12	-	2.50	3.50	-	6.00 (1.8-7.5)	1.73 (0.35-2.20)	3.48	6.0	7.6	A++
	9	14	-	2.50	4.00	-	6.50 (1.8-8.2)	2.04 (0.35-2.46)	3.19	6.5	7.2	A++
	9	18	-	2.27	4.53	-	6.80 (1.8-8.5)	2.26 (0.35-2.65)	3.01	6.8	6.9	A++
	12	12	-	3.40	3.40	-	6.80 (1.8-8.5)	2.26 (0.35-2.65)	3.01	6.8	6.9	A++
3-unit connection	7	7	7	2.00	2.00	2.00	6.00 (1.8-7.5)	1.37 (0.35-2.20)	4.37	6.0	8.6	A+++
	7	7	9	2.00	2.00	2.50	6.50 (1.8-8.2)	1.59 (0.35-2.46)	4.08	6.5	8.5	A+++
	7	7	12	1.83	1.83	3.14	6.80 (1.8-8.5)	1.74 (0.35-2.65)	3.90	6.8	8.5	A+++
	7	7	14	1.70	1.70	3.40	6.80 (1.8-8.5)	1.74 (0.35-2.65)	3.90	6.8	8.5	A+++
	7	7	18	1.49	1.49	3.82	6.80 (1.8-8.5)	1.74 (0.35-2.65)	3.90	6.8	8.5	A+++
	7	9	9	1.90	2.45	2.45	6.80 (1.8-8.5)	1.74 (0.35-2.65)	3.90	6.8	8.5	A+++
	7	9	12	1.70	2.19	2.91	6.80 (1.8-8.5)	1.74 (0.35-2.65)	3.90	6.8	8.5	A+++
	7	9	14	1.59	2.04	3.17	6.80 (1.8-8.5)	1.74 (0.35-2.65)	3.90	6.8	8.5	A+++
	7	9	18	1.40	1.80	3.60	6.80 (1.8-8.5)	1.74 (0.35-2.65)	3.90	6.8	8.5	A+++
	7	12	12	1.54	2.63	2.63	6.80 (1.8-8.5)	1.74 (0.35-2.65)	3.90	6.8	8.5	A+++
	7	12	14	1.44	2.47	2.89	6.80 (1.8-8.5)	1.74 (0.35-2.65)	3.90	6.8	8.5	A+++
	7	14	14	1.36	2.72	2.72	6.80 (1.8-8.5)	1.74 (0.35-2.65)	3.90	6.8	8.5	A+++
	9	9	9	2.27	2.27	2.27	6.80 (1.8-8.5)	1.74 (0.35-2.65)	3.90	6.8	8.5	A+++
	9	9	12	2.04	2.04	2.72	6.80 (1.8-8.5)	1.74 (0.35-2.65)	3.90	6.8	8.5	A+++
	9	9	14	1.91	1.91	2.98	6.80 (1.8-8.5)	1.74 (0.35-2.65)	3.90	6.8	8.5	A+++
	9	9	18	1.70	1.70	3.40	6.80 (1.8-8.5)	1.74 (0.35-2.65)	3.90	6.8	8.5	A+++
	9	12	12	1.86	2.47	2.47	6.80 (1.8-8.5)	1.74 (0.35-2.65)	3.90	6.8	8.5	A+++
	9	12	14	1.75	2.33	2.72	6.80 (1.8-8.5)	1.74 (0.35-2.65)	3.90	6.8	8.5	A+++
	12	12	12	2.27	2.27	2.27	6.80 (1.8-8.5)	1.74 (0.35-2.65)	3.90	6.8	8.5	A+++

Notes: •7: 7000 Btu/h/9: 9000 Btu/h/12: 12000 Btu/h/14: 14000 Btu/h/18: 18000 Btu/h models
 •The above specifications apply when connected with a wall-mounted unit.
 •2 or more indoor units should be connected.
 •Cooling capacity is determined based on 27°CDB/19°CWB (indoor temperature) and 35°CDB (outdoor temperature).
 •Pipe Length: 5 m, Height difference: 0 m (Outdoor unit to Indoor unit)
 •Total capacity of indoor units connected must be between 4.0 kW and 10.5 kW.

3-unit Multi-split heating

AOHG18KBTA3	Combination of Indoor Units			Heating Operation						Seasonal Data		
				Heating Capacity			Input Power (Min. - Max.) kW	COP	Pdesign kW	SCOP	Energy efficiency	
				Unit 1 kW	Unit 2 kW	Unit 3 kW						Total Capacity (Min. - Max.) kW
2-unit connection	7	7	-	2.40	2.40	-	4.80 (2.0-5.6)	1.00 (0.25-1.30)	4.80	4.0	4.2	A+
	7	9	-	2.40	3.00	-	5.40 (2.0-6.4)	1.21 (0.25-1.48)	4.45	4.0	4.2	A+
	7	12	-	2.40	4.20	-	6.60 (2.0-7.6)	1.66 (0.25-1.76)	3.98	5.0	4.0	A+
	7	14	-	2.27	4.53	-	6.80 (2.0-8.0)	1.77 (0.25-1.85)	3.84	5.0	4.0	A+
	9	9	-	3.00	3.00	-	6.00 (2.0-7.2)	1.44 (0.25-1.67)	4.17	4.5	4.1	A+
	9	12	-	2.91	3.89	-	6.80 (2.0-8.0)	1.77 (0.25-1.85)	3.84	5.0	4.0	A+
	9	14	-	2.66	4.14	-	6.80 (2.0-8.0)	1.77 (0.25-1.85)	3.84	5.0	4.0	A+
	12	12	-	3.40	3.40	-	6.80 (2.0-8.0)	1.77 (0.25-1.85)	3.84	5.0	4.0	A+
	12	14	-	3.14	3.66	-	6.80 (2.0-8.0)	1.77 (0.25-1.85)	3.84	5.0	4.0	A+
	14	14	-	3.40	3.40	-	6.80 (2.0-8.0)	1.77 (0.25-1.85)	3.84	5.0	4.0	A+
3-unit connection	7	7	7	2.27	2.27	2.27	6.80 (2.0-8.0)	1.39 (0.25-1.85)	4.89	5.0	4.7	A++
	7	7	9	2.07	2.07	2.66	6.80 (2.0-8.0)	1.39 (0.25-1.85)	4.89	5.0	4.7	A++
	7	7	12	1.83	1.83	3.14	6.80 (2.0-8.0)	1.39 (0.25-1.85)	4.89	5.0	4.7	A++
	7	7	14	1.70	1.70	3.40	6.80 (2.0-8.0)	1.39 (0.25-1.85)	4.89	5.0	4.7	A++
	7	9	9	1.90	2.45	2.45	6.80 (2.0-8.0)	1.39 (0.25-1.85)	4.89	5.0	4.7	A++
	7	9	12	1.70	2.19	2.91	6.80 (2.0-8.0)	1.39 (0.25-1.85)	4.89	5.0	4.7	A++
	7	9	14	1.59	2.04	3.17	6.80 (2.0-8.0)	1.39 (0.25-1.85)	4.89	5.0	4.7	A++
	9	9	9	2.27	2.27	2.27	6.80 (2.0-8.0)	1.39 (0.25-1.85)	4.89	5.0	4.7	A++
	9	9	12	2.04	2.04	2.72	6.80 (2.0-8.0)	1.39 (0.25-1.85)	4.89	5.0	4.7	A++

AOHG24KBTA3	Combination of Indoor Units			Heating Operation						Seasonal Data		
				Heating Capacity			Input Power (Min. - Max.) kW	COP	Pdesign kW	SCOP	Energy efficiency	
				Unit 1 kW	Unit 2 kW	Unit 3 kW						Total Capacity (Min. - Max.) kW
2-unit connection	7	7	-	2.40	2.40	-	4.80 (2.0-5.6)	1.00 (0.25-1.30)	4.80	4.0	4.2	A+
	7	9	-	2.40	3.00	-	5.40 (2.0-6.4)	1.21 (0.25-1.48)	4.45	4.0	4.2	A+
	7	12	-	2.40	4.20	-	6.60 (2.0-7.6)	1.66 (0.25-1.76)	3.98	5.0	4.0	A+
	7	14	-	2.40	4.80	-	7.20 (2.0-8.4)	1.86 (0.25-2.07)	3.87	5.4	4.0	A+
	7	18	-	2.16	5.54	-	7.70 (2.0-9.2)	2.01 (0.25-2.35)	3.83	5.8	4.0	A+
	9	9	-	3.00	3.00	-	6.00 (2.0-7.2)	1.44 (0.25-1.67)	4.17	4.5	4.1	A+
	9	12	-	3.00	4.20	-	7.20 (2.0-8.4)	1.86 (0.25-2.07)	3.87	5.4	4.0	A+
	9	14	-	2.96	4.74	-	7.70 (2.0-9.2)	2.01 (0.25-2.35)	3.83	5.8	4.0	A+
	9	18	-	2.57	5.13	-	7.70 (2.0-9.2)	2.01 (0.25-2.35)	3.83	5.8	4.0	A+
	12	12	-	3.85	3.85	-	7.70 (2.0-9.2)	2.01 (0.25-2.35)	3.83	5.8	4.0	A+
3-unit connection	7	7	7	2.40	2.40	2.40	7.20 (2.0-8.4)	1.61 (0.25-2.07)	4.48	5.4	4.7	A++
	7	7	9	2.40	2.40	3.00	7.80 (2.0-9.2)	1.76 (0.25-2.35)	4.42	5.8	4.6	A++
	7	7	12	2.15	2.15	3.70	8.00 (2.0-9.2)	1.82 (0.25-2.35)	4.40	6.0	4.6	A++
	7	7	14	2.00	2.00	4.00	8.00 (2.0-9.2)	1.82 (0.25-2.35)	4.40	6.0	4.6	A++
	7	7	18	1.75	1.75	4.50	8.00 (2.0-9.2)	1.82 (0.25-2.35)	4.40	6.0	4.6	A++
	7	9	9	2.24	2.88	2.88	8.00 (2.0-9.2)	1.82 (0.25-2.35)	4.40	6.0	4.6	A++
	7	9	12	2.00	2.57	3.43	8.00 (2.0-9.2)	1.82 (0.25-2.35)	4.40	6.0	4.6	A++
	7	9	14	1.87	2.40	3.73	8.00 (2.0-9.2)	1.82 (0.25-2.35)	4.40	6.0	4.6	A++
	7	9	18	1.65	2.12	4.23	8.00 (2.0-9.2)	1.82 (0.25-2.35)	4.40	6.0	4.6	A++
	7	12	12	1.80	3.10							



4-unit Multi-split Combination Table-Cooling/Heating

4-unit Multi-split cooling

AOHG30KBTA4	Combination of Indoor Units		Cooling Operation						Seasonal Data											
			Cooling Capacity				Total Capacity (Min. - Max.)	Input Power (Min. - Max.)	EER	Pdesign	SEER	Energy efficiency								
			Unit 1	Unit 2	Unit 3	Unit 4														
			kW	kW	kW	kW	kW	kW												
2-unit connection	7	22	-	-	2.00	6.00	-	-	8.00 (2.4-10.1)	2.67 (0.45-3.25)	3.00	8.0	7.5	A++						
	7	24	-	-	1.81	6.19	-	-	8.00 (2.4-10.1)	2.67 (0.45-3.25)	3.00	8.0	7.5	A++						
	9	22	-	-	2.32	5.68	-	-	8.00 (2.4-10.1)	2.67 (0.45-3.25)	3.00	8.0	7.5	A++						
	9	24	-	-	2.18	5.82	-	-	8.00 (2.4-10.1)	2.67 (0.45-3.25)	3.00	8.0	7.5	A++						
	12	18	-	-	3.20	4.80	-	-	8.00 (2.4-10.1)	2.67 (0.45-3.25)	3.00	8.0	7.5	A++						
	12	22	-	-	2.82	5.18	-	-	8.00 (2.4-10.1)	2.67 (0.45-3.25)	3.00	8.0	7.5	A++						
	12	24	-	-	2.67	5.33	-	-	8.00 (2.4-10.1)	2.67 (0.45-3.25)	3.00	8.0	7.5	A++						
	14	18	-	-	3.50	4.50	-	-	8.00 (2.4-10.1)	2.67 (0.45-3.25)	3.00	8.0	7.5	A++						
	14	22	-	-	3.11	4.89	-	-	8.00 (2.4-10.1)	2.67 (0.45-3.25)	3.00	8.0	7.5	A++						
	14	24	-	-	2.95	5.05	-	-	8.00 (2.4-10.1)	2.67 (0.45-3.25)	3.00	8.0	7.5	A++						
	18	18	-	-	4.00	4.00	-	-	8.00 (2.4-10.1)	2.67 (0.45-3.25)	3.00	8.0	7.5	A++						
	18	22	-	-	3.60	4.40	-	-	8.00 (2.4-10.1)	2.67 (0.45-3.25)	3.00	8.0	7.5	A++						
	18	24	-	-	3.43	4.57	-	-	8.00 (2.4-10.1)	2.67 (0.45-3.25)	3.00	8.0	7.5	A++						
	22	22	-	-	4.00	4.00	-	-	8.00 (2.4-10.1)	2.67 (0.45-3.25)	3.00	8.0	7.5	A++						
	22	24	-	-	3.83	4.17	-	-	8.00 (2.4-10.1)	2.67 (0.45-3.25)	3.00	8.0	7.5	A++						
	24	24	-	-	4.00	4.00	-	-	8.00 (2.4-10.1)	2.67 (0.45-3.25)	3.00	8.0	7.5	A++						
	3-unit connection	7	7	12	-	2.00	2.00	3.50	-	7.50 (2.4-9.3)	2.10 (0.45-2.84)	3.57	7.5	8.1	A++					
		7	7	14	-	2.00	2.00	4.00	-	8.00 (2.4-10.1)	2.32 (0.45-3.25)	3.45	8.0	8.0	A++					
		7	7	18	-	1.75	1.75	4.50	-	8.00 (2.4-10.1)	2.32 (0.45-3.25)	3.45	8.0	8.0	A++					
		7	7	22	-	1.56	1.56	4.88	-	8.00 (2.4-10.1)	2.32 (0.45-3.25)	3.45	8.0	8.0	A++					
		7	7	24	-	1.47	1.47	5.06	-	8.00 (2.4-10.1)	2.32 (0.45-3.25)	3.45	8.0	8.0	A++					
		7	9	9	-	2.00	2.50	2.50	-	7.00 (2.4-8.9)	1.90 (0.45-2.65)	3.69	7.0	8.2	A++					
		7	9	12	-	2.00	2.50	3.50	-	8.00 (2.4-10.1)	2.32 (0.45-3.25)	3.45	8.0	8.0	A++					
		7	9	14	-	1.87	2.40	3.73	-	8.00 (2.4-10.1)	2.32 (0.45-3.25)	3.45	8.0	8.0	A++					
7		9	18	-	1.64	2.12	4.24	-	8.00 (2.4-10.1)	2.32 (0.45-3.25)	3.45	8.0	8.0	A++						
7		9	22	-	1.47	1.89	4.64	-	8.00 (2.4-10.1)	2.32 (0.45-3.25)	3.45	8.0	8.0	A++						
7		9	24	-	1.40	1.80	4.80	-	8.00 (2.4-10.1)	2.32 (0.45-3.25)	3.45	8.0	8.0	A++						
7		12	12	-	1.80	3.10	3.10	-	8.00 (2.4-10.1)	2.32 (0.45-3.25)	3.45	8.0	8.0	A++						
7		12	14	-	1.70	2.91	3.39	-	8.00 (2.4-10.1)	2.32 (0.45-3.25)	3.45	8.0	8.0	A++						
7		12	18	-	1.51	2.59	3.90	-	8.00 (2.4-10.1)	2.32 (0.45-3.25)	3.45	8.0	8.0	A++						
7		12	22	-	1.37	2.34	4.29	-	8.00 (2.4-10.1)	2.32 (0.45-3.25)	3.45	8.0	8.0	A++						
7		12	24	-	1.30	2.23	4.47	-	8.00 (2.4-10.1)	2.32 (0.45-3.25)	3.45	8.0	8.0	A++						
7		14	14	-	1.60	3.20	3.20	-	8.00 (2.4-10.1)	2.32 (0.45-3.25)	3.45	8.0	8.0	A++						
7		14	18	-	1.44	2.87	3.69	-	8.00 (2.4-10.1)	2.32 (0.45-3.25)	3.45	8.0	8.0	A++						
7		14	22	-	1.30	2.60	4.10	-	8.00 (2.4-10.1)	2.32 (0.45-3.25)	3.45	8.0	8.0	A++						
7		14	24	-	1.24	2.49	4.27	-	8.00 (2.4-10.1)	2.32 (0.45-3.25)	3.45	8.0	8.0	A++						
7		18	18	-	1.30	3.35	3.35	-	8.00 (2.4-10.1)	2.32 (0.45-3.25)	3.45	8.0	8.0	A++						
7		18	22	-	1.19	3.06	3.75	-	8.00 (2.4-10.1)	2.32 (0.45-3.25)	3.45	8.0	8.0	A++						
7		18	24	-	1.14	2.94	3.92	-	8.00 (2.4-10.1)	2.32 (0.45-3.25)	3.45	8.0	8.0	A++						
9		9	9	-	2.50	2.50	2.50	-	7.50 (2.4-9.6)	2.10 (0.45-3.01)	3.57	7.5	8.1	A++						
9	9	12	-	2.40	2.40	3.20	-	8.00 (2.4-10.1)	2.32 (0.45-3.25)	3.45	8.0	8.0	A++							
9	9	14	-	2.25	2.25	3.50	-	8.00 (2.4-10.1)	2.32 (0.45-3.25)	3.45	8.0	8.0	A++							
9	9	18	-	2.00	2.00	4.00	-	8.00 (2.4-10.1)	2.32 (0.45-3.25)	3.45	8.0	8.0	A++							
9	9	22	-	1.80	1.80	4.40	-	8.00 (2.4-10.1)	2.32 (0.45-3.25)	3.45	8.0	8.0	A++							
9	9	24	-	1.71	1.71	4.58	-	8.00 (2.4-10.1)	2.32 (0.45-3.25)	3.45	8.0	8.0	A++							
9	12	12	-	2.18	2.91	2.91	-	8.00 (2.4-10.1)	2.32 (0.45-3.25)	3.45	8.0	8.0	A++							
9	12	14	-	2.06	2.74	3.20	-	8.00 (2.4-10.1)	2.32 (0.45-3.25)	3.45	8.0	8.0	A++							
9	12	18	-	1.85	2.46	3.69	-	8.00 (2.4-10.1)	2.32 (0.45-3.25)	3.45	8.0	8.0	A++							
9	12	22	-	1.67	2.23	4.10	-	8.00 (2.4-10.1)	2.32 (0.45-3.25)	3.45	8.0	8.0	A++							
9	12	24	-	1.60	2.13	4.27	-	8.00 (2.4-10.1)	2.32 (0.45-3.25)	3.45	8.0	8.0	A++							
9	14	14	-	1.94	3.03	3.03	-	8.00 (2.4-10.1)	2.32 (0.45-3.25)	3.45	8.0	8.0	A++							
9	14	18	-	1.76	2.73	3.51	-	8.00 (2.4-10.1)	2.32 (0.45-3.25)	3.45	8.0	8.0	A++							
9	14	22	-	1.60	2.49	3.91	-	8.00 (2.4-10.1)	2.32 (0.45-3.25)	3.45	8.0	8.0	A++							
9	14	24	-	1.53	2.38	4.09	-	8.00 (2.4-10.1)	2.32 (0.45-3.25)	3.45	8.0	8.0	A++							
9	18	18	-	1.60	3.20	3.20	-	8.00 (2.4-10.1)	2.32 (0.45-3.25)	3.45	8.0	8.0	A++							
12	12	12	-	2.67	2.67	2.67	-	8.00 (2.4-10.1)	2.32 (0.45-3.25)	3.45	8.0	8.0	A++							
12	12	14	-	2.53	2.53	2.94	-	8.00 (2.4-10.1)	2.32 (0.45-3.25)	3.45	8.0	8.0	A++							
12	12	18	-	2.29	2.29	3.42	-	8.00 (2.4-10.1)	2.32 (0.45-3.25)	3.45	8.0	8.0	A++							
12	12	22	-	2.09	2.09	3.82	-	8.00 (2.4-10.1)	2.32 (0.45-3.25)	3.45	8.0	8.0	A++							
12	12	24	-	2.00	2.00	4.00	-	8.00 (2.4-10.1)	2.32 (0.45-3.25)	3.45	8.0	8.0	A++							
12	14	14	-	2.40	2.80	2.80	-	8.00 (2.4-10.1)	2.32 (0.45-3.25)	3.45	8.0	8.0	A++							
12	14	18	-	2.18	2.55	3.27	-	8.00 (2.4-10.1)	2.32 (0.45-3.25)	3.45	8.0	8.0	A++							
12	14	22	-	2.00	2.30	3.00	-	8.00 (2.4-10.1)	2.32 (0.45-3.25)	3.45	8.0	8.0	A++							
12	14	24	-	1.93	2.19	3.14	-	8.00 (2.4-10.1)	2.32 (0.45-3.25)	3.45	8.0	8.0	A++							
14	14	18	-	2.00	2.00	2.00	2.00	8.00 (2.4-10.1)	2.05 (0.45-3.25)	3.90	8.0	8.5	A+++							
7	7	7	12	1.70	1.70	1.70	2.90	8.00 (2.4-10.1)	2.05 (0.45-3.25)	3.90	8.0	8.5	A+++							
7	7	7	14	1.60	1.60	1.60	3.20	8.00 (2.4-10.1)	2.05 (0.45-3.25)	3.90	8.0	8.5	A+++							
7	7	7	18	1.44	1.44	1.44	3.68	8.00 (2.4-10.1)	2.05 (0.45-3.25)	3.90	8.0	8.5	A+++							
7	7	9	9	1.75	1.75	2.25	2.25	8.00 (2.4-10.1)	2.05 (0.45-3.25)	3.90	8.0	8.5	A+++							
7	7																			



5-unit Multi-split Combination Table-Cooling

5-unit Multi-split cooling

AOHG36K8TA5	Combination of Indoor Units					Cooling Operation					Seasonal Data					
						Cooling Capacity					Input Power (Min. - Max.)	EER	Pdesign kW	SEER	Energy efficiency	
						Unit 1	Unit 2	Unit 3	Unit 4	Unit 5						Total Capacity (Min. - Max.)
kW						kW										
2-unit connection	7	24	-	-	-	2.00	7.00	-	-	-	9.00 (3.0-11.0)	2.91 (0.30-3.45)	3.09	9.0	7.9	A++
	9	22	-	-	-	2.50	6.00	-	-	-	8.50 (3.0-11.0)	2.67 (0.30-3.45)	3.18	8.5	7.9	A++
	9	24	-	-	-	2.50	7.00	-	-	-	9.50 (3.0-11.0)	3.17 (0.30-3.45)	3.00	9.5	7.8	A++
	12	22	-	-	-	3.50	6.00	-	-	-	9.50 (3.0-11.0)	3.17 (0.30-3.45)	3.00	9.5	7.8	A++
	12	24	-	-	-	3.17	6.33	-	-	-	9.50 (3.0-11.0)	3.17 (0.30-3.45)	3.00	9.5	7.8	A++
	14	22	-	-	-	3.69	5.61	-	-	-	9.50 (3.0-11.0)	3.17 (0.30-3.45)	3.00	9.5	7.8	A++
	14	24	-	-	-	3.50	6.00	-	-	-	9.50 (3.0-11.0)	3.17 (0.30-3.45)	3.00	9.5	7.8	A++
	18	18	-	-	-	4.75	4.75	-	-	-	9.50 (3.0-11.0)	3.17 (0.30-3.45)	3.00	9.5	7.8	A++
	18	22	-	-	-	4.27	5.23	-	-	-	9.50 (3.0-11.0)	3.17 (0.30-3.45)	3.00	9.5	7.8	A++
	18	24	-	-	-	4.07	5.43	-	-	-	9.50 (3.0-11.0)	3.17 (0.30-3.45)	3.00	9.5	7.8	A++
	22	22	-	-	-	4.75	4.75	-	-	-	9.50 (3.0-11.0)	3.17 (0.30-3.45)	3.00	9.5	7.8	A++
	22	24	-	-	-	4.54	4.96	-	-	-	9.50 (3.0-11.0)	3.17 (0.30-3.45)	3.00	9.5	7.8	A++
	24	24	-	-	-	4.75	4.75	-	-	-	9.50 (3.0-11.0)	3.17 (0.30-3.45)	3.00	9.5	7.8	A++
	7	7	14	-	-	2.00	2.00	4.00	-	-	8.00 (3.0-10.0)	2.26 (0.30-2.88)	3.54	8.0	8.2	A++
	7	7	18	-	-	2.00	2.00	5.00	-	-	9.00 (3.0-11.0)	2.68 (0.30-3.45)	3.36	9.0	8.1	A++
	7	7	22	-	-	1.85	1.85	5.80	-	-	9.50 (3.0-11.0)	2.91 (0.30-3.45)	3.27	9.5	8.0	A++
	7	7	24	-	-	1.75	1.75	6.00	-	-	9.50 (3.0-11.0)	2.91 (0.30-3.45)	3.27	9.5	8.0	A++
	7	9	12	-	-	2.00	2.50	3.50	-	-	8.00 (3.0-10.0)	2.26 (0.30-2.88)	3.54	8.0	8.2	A++
	7	9	14	-	-	2.00	2.50	4.00	-	-	8.50 (3.0-10.7)	2.46 (0.30-3.27)	3.45	8.5	8.1	A++
	7	9	18	-	-	2.00	2.50	5.00	-	-	9.50 (3.0-11.0)	2.91 (0.30-3.45)	3.27	9.5	8.0	A++
	7	9	22	-	-	1.75	2.25	5.50	-	-	9.50 (3.0-11.0)	2.91 (0.30-3.45)	3.27	9.5	8.0	A++
	7	9	24	-	-	1.66	2.14	5.70	-	-	9.50 (3.0-11.0)	2.91 (0.30-3.45)	3.27	9.5	8.0	A++
	7	12	12	-	-	2.00	3.50	3.50	-	-	9.50 (3.0-11.0)	2.91 (0.30-3.45)	3.27	9.5	8.0	A++
	7	12	14	-	-	2.00	3.50	4.00	-	-	9.50 (3.0-11.0)	2.91 (0.30-3.45)	3.27	9.5	8.0	A++
7	12	18	-	-	1.80	3.08	4.62	-	-	9.50 (3.0-11.0)	2.91 (0.30-3.45)	3.27	9.5	8.0	A++	
7	12	22	-	-	1.62	2.78	5.10	-	-	9.50 (3.0-11.0)	2.91 (0.30-3.45)	3.27	9.5	8.0	A++	
7	12	24	-	-	1.55	2.65	5.30	-	-	9.50 (3.0-11.0)	2.91 (0.30-3.45)	3.27	9.5	8.0	A++	
7	14	14	-	-	1.90	3.80	3.80	-	-	9.50 (3.0-11.0)	2.91 (0.30-3.45)	3.27	9.5	8.0	A++	
7	14	18	-	-	1.71	3.41	4.38	-	-	9.50 (3.0-11.0)	2.91 (0.30-3.45)	3.27	9.5	8.0	A++	
7	14	22	-	-	1.55	3.09	4.86	-	-	9.50 (3.0-11.0)	2.91 (0.30-3.45)	3.27	9.5	8.0	A++	
7	14	24	-	-	1.47	2.96	5.07	-	-	9.50 (3.0-11.0)	2.91 (0.30-3.45)	3.27	9.5	8.0	A++	
7	18	18	-	-	1.54	3.98	3.98	-	-	9.50 (3.0-11.0)	2.91 (0.30-3.45)	3.27	9.5	8.0	A++	
7	18	22	-	-	1.41	3.64	4.45	-	-	9.50 (3.0-11.0)	2.91 (0.30-3.45)	3.27	9.5	8.0	A++	
7	18	24	-	-	1.36	3.49	4.65	-	-	9.50 (3.0-11.0)	2.91 (0.30-3.45)	3.27	9.5	8.0	A++	
9	9	9	-	-	2.50	2.50	2.50	-	-	7.50 (3.0-9.6)	2.07 (0.30-2.70)	3.63	7.5	8.2	A++	
9	9	12	-	-	2.50	2.50	3.50	-	-	8.50 (3.0-10.7)	2.46 (0.30-3.27)	3.45	8.5	8.1	A++	
9	9	14	-	-	2.50	2.50	4.00	-	-	9.00 (3.0-11.0)	2.68 (0.30-3.45)	3.36	9.0	8.1	A++	
9	9	18	-	-	2.38	2.38	4.74	-	-	9.50 (3.0-11.0)	2.91 (0.30-3.45)	3.27	9.5	8.0	A++	
9	9	22	-	-	2.14	2.14	5.22	-	-	9.50 (3.0-11.0)	2.91 (0.30-3.45)	3.27	9.5	8.0	A++	
9	9	24	-	-	2.04	2.04	5.42	-	-	9.50 (3.0-11.0)	2.91 (0.30-3.45)	3.27	9.5	8.0	A++	
9	12	12	-	-	2.50	3.50	3.50	-	-	9.50 (3.0-11.0)	2.91 (0.30-3.45)	3.27	9.5	8.0	A++	
9	12	14	-	-	2.44	3.26	3.80	-	-	9.50 (3.0-11.0)	2.91 (0.30-3.45)	3.27	9.5	8.0	A++	
9	12	18	-	-	2.19	2.92	4.39	-	-	9.50 (3.0-11.0)	2.91 (0.30-3.45)	3.27	9.5	8.0	A++	
9	12	22	-	-	1.99	2.65	4.86	-	-	9.50 (3.0-11.0)	2.91 (0.30-3.45)	3.27	9.5	8.0	A++	
9	12	24	-	-	1.90	2.53	5.07	-	-	9.50 (3.0-11.0)	2.91 (0.30-3.45)	3.27	9.5	8.0	A++	
9	14	14	-	-	2.32	3.59	3.59	-	-	9.50 (3.0-11.0)	2.91 (0.30-3.45)	3.27	9.5	8.0	A++	
9	14	18	-	-	2.09	3.24	4.17	-	-	9.50 (3.0-11.0)	2.91 (0.30-3.45)	3.27	9.5	8.0	A++	
9	14	22	-	-	1.90	2.96	4.64	-	-	9.50 (3.0-11.0)	2.91 (0.30-3.45)	3.27	9.5	8.0	A++	
9	14	24	-	-	1.82	2.83	4.85	-	-	9.50 (3.0-11.0)	2.91 (0.30-3.45)	3.27	9.5	8.0	A++	
9	18	18	-	-	2.00	3.80	3.80	-	-	9.50 (3.0-11.0)	2.91 (0.30-3.45)	3.27	9.5	8.0	A++	
9	18	22	-	-	1.74	3.49	4.27	-	-	9.50 (3.0-11.0)	2.91 (0.30-3.45)	3.27	9.5	8.0	A++	
9	18	24	-	-	1.68	3.35	4.47	-	-	9.50 (3.0-11.0)	2.91 (0.30-3.45)	3.27	9.5	8.0	A++	
12	12	12	-	-	3.17	3.17	3.17	-	-	9.50 (3.0-11.0)	2.91 (0.30-3.45)	3.27	9.5	8.0	A++	
12	12	14	-	-	3.00	3.00	3.50	-	-	9.50 (3.0-11.0)	2.91 (0.30-3.45)	3.27	9.5	8.0	A++	
12	12	18	-	-	2.71	2.71	4.08	-	-	9.50 (3.0-11.0)	2.91 (0.30-3.45)	3.27	9.5	8.0	A++	
12	12	22	-	-	2.48	2.48	4.54	-	-	9.50 (3.0-11.0)	2.91 (0.30-3.45)	3.27	9.5	8.0	A++	
12	12	24	-	-	2.38	2.38	4.74	-	-	9.50 (3.0-11.0)	2.91 (0.30-3.45)	3.27	9.5	8.0	A++	
12	14	14	-	-	2.84	3.33	3.33	-	-	9.50 (3.0-11.0)	2.91 (0.30-3.45)	3.27	9.5	8.0	A++	
12	14	18	-	-	2.59	3.02	3.89	-	-	9.50 (3.0-11.0)	2.91 (0.30-3.45)	3.27	9.5	8.0	A++	
12	14	22	-	-	2.38	2.77	4.35	-	-	9.50 (3.0-11.0)	2.91 (0.30-3.45)	3.27	9.5	8.0	A++	
12	14	24	-	-	2.28	2.66	4.56	-	-	9.50 (3.0-11.0)	2.91 (0.30-3.45)	3.27	9.5	8.0	A++	
12	18	18	-	-	2.38	3.56	3.56	-	-	9.50 (3.0-11.0)	2.91 (0.30-3.45)	3.27	9.5	8.0	A++	
12	18	22	-	-	2.19	3.29	4.02	-	-	9.50 (3.0-11.0)	2.91 (0.30-3.45)	3.27	9.5	8.0	A++	
12	18	24	-	-	2.11	3.17	4.22	-	-	9.50 (3.0-11.0)	2.91 (0.30-3.45)	3.27	9.5	8.0	A++	
14	14	14	-	-	3.17	3.17	3.17	-	-	9.50 (3.0-11.0)	2.91 (0.30-3.45)	3.27	9.5	8.0	A++	
14	14	18	-	-	2.89	2.89	3.72	-	-	9.50 (3.0-11.0)	2.91 (0.30-3.45)	3.27	9.5	8.0	A++	
14	14	22	-	-	2.66	2.66	4.18	-	-	9.50 (3.0-11.0)	2.91 (0.30-3.45)	3.27	9.5	8.0	A++	
14	14	24	-	-	2.56	2.56	4.38	-	-	9.50 (3.0-11.0)	2.91 (0.30-3.45)	3.27	9.5	8.0	A++	
14	18	18	-	-	2.66	3.42	3.42	-	-	9.50 (3.0-11.0)	2.91 (0.30-3.45)	3.27	9.5	8.0	A++	
18	18	18	-	-	3.17	3.17	3.17	-	-	9.50 (3.0-11.0)	2.91 (0.30-3.45)	3.27	9.5	8.0	A++	
7	7	7	7	-	2.00	2.00	2.00	2.00	-	8.00 (3.0-10.0)	2.11 (0.30-2.88)	3.80	8.0	8.5	A++	
7	7	7	9	-	2.00	2.00	2.00	2.50	-	8.50 (3.0-10.7)	2.29 (0.30-3.27)	3.71	8.5	8.4	A++	
7	7	7	12	-	2.00	2.00	2.00	3.50	-	9.50 (3.0-11.0)	2.69 (0.30-3.45)	3.53	9.5	8.3	A++	
7	7	7	14	-	1.90	1.90	1.90	3.80	-	9.50 (3.0-11.0)	2.69 (0.30-3.45)	3.53	9.5	8.3	A++	
7	7	7	18	-	1.71	1.71	1.71	4.37	-	9.50 (3.0-11.0)	2.69 (0.30-3.45)	3.53	9.5	8.3	A++	
7	7	7	22	-	1.55	1.55	1.55	4.85	-	9.50 (3.0-11.0)	2.69 (0.30-3.45)	3.53	9.5	8.3	A++	
7	7	7	24	-	1.48	1.48	1.48	5.06	-	9.50 (3.0-11.0)	2.69 (0.30-3.45)	3.53	9.5	8.3	A++	
7	7	9	9	-	2.00	2.00	2.50	2.50	-	9.00 (3.0-11.0)	2.49 (0.30-3.45)	3.62	9.0	8.4	A++	
7	7	9	12	-	1.90	1.90	2.44	3.26	-	9.50 (3.0-11.0)	2.69 (0.30-3.45)	3.53	9.5	8.3	A++	
7	7	9	14	-	1.80	1.80	2.31	3.59	-	9.50 (3.0-11.0)	2.69 (0.30-3.45)	3.53	9.5	8.3	A++	
7	7	9	18	-	1.62	1.62	2.09	4.17	-	9.50 (3.0-11.0)	2.69 (0.30-3.45)	3.53	9.5	8.3	A++	
7	7	9	22	-	1.48	1.48	1.90	4.64	-	9.50 (3.0-11.0)	2.69 (0.30-3.45)	3.53	9.5	8.3	A++	
7	7	9	24	-	1.41	1.41	1.82	4.86	-	9.50 (3.0-11.0)	2.69 (0.30-3.45)	3.53	9.5	8.3	A++	
7	7	12	12	-	1.75	1.75	3.00	3.00	-	9.50 (3.0-11.0)	2.69 (0.30-3.45)	3.53	9.5	8.3	A++	
7	7	12	14	-	1.66	1.66	2.85	3.33	-	9.50 (3.0-11.0)	2.69 (0.30-3.45)	3.53	9.5	8.3	A++	
7	7	12														



5-unit Multi-split Combination Table-Heating

5-unit Multi-split heating

AOHG36K8TA5	Combination of Indoor Units					Heating Operation						Seasonal Data				
						Heating Capacity					Input Power (Min. - Max.)	COP	Pdesign kW	SCOP	Energy efficiency	
						Unit 1	Unit 2	Unit 3	Unit 4	Unit 5						Total Capacity (Min. - Max.)
2-unit connection	7	24	-	-	-	2.39	8.21	-	-	-	10.60 (3.5-12.0)	2.65 (0.25-3.25)	4.00	7.0	4.3	A+
	9	22	-	-	-	3.00	7.20	-	-	-	10.20 (3.5-12.0)	2.52 (0.25-3.25)	4.04	6.8	4.3	A+
	9	24	-	-	-	2.89	7.71	-	-	-	10.60 (3.5-12.0)	2.65 (0.25-3.25)	4.00	7.0	4.3	A+
	12	22	-	-	-	3.74	6.86	-	-	-	10.60 (3.5-12.0)	2.65 (0.25-3.25)	4.00	7.0	4.3	A+
	12	24	-	-	-	3.53	7.07	-	-	-	10.60 (3.5-12.0)	2.65 (0.25-3.25)	4.00	7.0	4.3	A+
	14	24	-	-	-	4.12	3.68	-	-	-	10.60 (3.5-12.0)	2.65 (0.25-3.25)	4.00	7.0	4.3	A+
	14	24	-	-	-	3.91	6.69	-	-	-	10.60 (3.5-12.0)	2.65 (0.25-3.25)	4.00	7.0	4.3	A+
	18	18	-	-	-	5.30	5.30	-	-	-	10.60 (3.5-12.0)	2.65 (0.25-3.25)	4.00	7.0	4.3	A+
	18	22	-	-	-	4.77	5.83	-	-	-	10.60 (3.5-12.0)	2.65 (0.25-3.25)	4.00	7.0	4.3	A+
	18	24	-	-	-	4.54	6.06	-	-	-	10.60 (3.5-12.0)	2.65 (0.25-3.25)	4.00	7.0	4.3	A+
	22	22	-	-	-	5.30	5.30	-	-	-	10.60 (3.5-12.0)	2.65 (0.25-3.25)	4.00	7.0	4.3	A+
	22	24	-	-	-	5.07	5.53	-	-	-	10.60 (3.5-12.0)	2.65 (0.25-3.25)	4.00	7.0	4.3	A+
	24	24	-	-	-	5.30	5.30	-	-	-	10.60 (3.5-12.0)	2.65 (0.25-3.25)	4.00	7.0	4.3	A+
	7	7	14	-	-	2.40	2.40	4.80	-	-	9.60 (3.5-11.2)	2.25 (0.25-2.87)	4.26	6.5	4.5	A+
	7	7	18	-	-	2.32	2.32	5.96	-	-	10.60 (3.5-12.0)	2.54 (0.25-3.25)	4.18	7.0	4.4	A+
	7	7	22	-	-	2.06	2.06	6.48	-	-	10.60 (3.5-12.0)	2.54 (0.25-3.25)	4.18	7.0	4.4	A+
	7	7	24	-	-	1.95	1.95	6.70	-	-	10.60 (3.5-12.0)	2.54 (0.25-3.25)	4.18	7.0	4.4	A+
	7	9	12	-	-	2.40	3.00	4.20	-	-	9.60 (3.5-11.2)	2.25 (0.25-2.87)	4.26	6.5	4.5	A+
7	9	14	-	-	2.40	3.00	4.80	-	-	10.20 (3.5-12.0)	2.42 (0.25-3.25)	4.21	6.8	4.4	A+	
7	9	18	-	-	2.18	2.81	5.61	-	-	10.60 (3.5-12.0)	2.54 (0.25-3.25)	4.18	7.0	4.4	A+	
7	9	22	-	-	1.95	2.51	6.14	-	-	10.60 (3.5-12.0)	2.54 (0.25-3.25)	4.18	7.0	4.4	A+	
7	9	24	-	-	1.85	2.39	6.36	-	-	10.60 (3.5-12.0)	2.54 (0.25-3.25)	4.18	7.0	4.4	A+	
7	12	12	-	-	1.72	4.44	4.44	-	-	10.60 (3.5-12.0)	2.54 (0.25-3.25)	4.18	7.0	4.4	A+	
7	12	14	-	-	2.25	3.85	4.50	-	-	10.60 (3.5-12.0)	2.54 (0.25-3.25)	4.18	7.0	4.4	A+	
7	12	18	-	-	2.00	3.44	5.16	-	-	10.60 (3.5-12.0)	2.54 (0.25-3.25)	4.18	7.0	4.4	A+	
7	12	22	-	-	1.81	3.10	5.69	-	-	10.60 (3.5-12.0)	2.54 (0.25-3.25)	4.18	7.0	4.4	A+	
7	12	24	-	-	1.72	2.96	5.92	-	-	10.60 (3.5-12.0)	2.54 (0.25-3.25)	4.18	7.0	4.4	A+	
7	14	14	-	-	2.12	4.24	4.24	-	-	10.60 (3.5-12.0)	2.54 (0.25-3.25)	4.18	7.0	4.4	A+	
7	14	18	-	-	1.90	3.81	4.89	-	-	10.60 (3.5-12.0)	2.54 (0.25-3.25)	4.18	7.0	4.4	A+	
7	14	22	-	-	1.73	3.45	5.42	-	-	10.60 (3.5-12.0)	2.54 (0.25-3.25)	4.18	7.0	4.4	A+	
7	14	24	-	-	1.65	3.30	5.65	-	-	10.60 (3.5-12.0)	2.54 (0.25-3.25)	4.18	7.0	4.4	A+	
7	18	18	-	-	1.72	4.44	4.44	-	-	10.60 (3.5-12.0)	2.54 (0.25-3.25)	4.18	7.0	4.4	A+	
7	18	22	-	-	1.58	4.06	4.96	-	-	10.60 (3.5-12.0)	2.54 (0.25-3.25)	4.18	7.0	4.4	A+	
7	18	24	-	-	1.51	3.89	5.20	-	-	10.60 (3.5-12.0)	2.54 (0.25-3.25)	4.18	7.0	4.4	A+	
9	9	9	-	-	3.00	3.00	3.00	-	-	9.00 (3.5-10.8)	2.09 (0.25-2.70)	4.31	6.0	4.5	A+	
9	9	12	-	-	3.00	3.00	4.20	-	-	10.20 (3.5-12.0)	2.42 (0.25-3.25)	4.21	6.8	4.4	A+	
9	9	14	-	-	2.98	2.98	4.64	-	-	10.60 (3.5-12.0)	2.54 (0.25-3.25)	4.18	7.0	4.4	A+	
9	9	18	-	-	2.65	2.65	5.30	-	-	10.60 (3.5-12.0)	2.54 (0.25-3.25)	4.18	7.0	4.4	A+	
9	9	22	-	-	2.39	2.39	5.82	-	-	10.60 (3.5-12.0)	2.54 (0.25-3.25)	4.18	7.0	4.4	A+	
9	9	24	-	-	2.27	2.27	6.06	-	-	10.60 (3.5-12.0)	2.54 (0.25-3.25)	4.18	7.0	4.4	A+	
9	12	12	-	-	2.80	3.85	3.85	-	-	10.60 (3.5-12.0)	2.54 (0.25-3.25)	4.18	7.0	4.4	A+	
9	12	14	-	-	2.73	3.63	4.24	-	-	10.60 (3.5-12.0)	2.54 (0.25-3.25)	4.18	7.0	4.4	A+	
9	12	18	-	-	2.45	3.26	4.89	-	-	10.60 (3.5-12.0)	2.54 (0.25-3.25)	4.18	7.0	4.4	A+	
9	12	22	-	-	2.22	2.96	5.42	-	-	10.60 (3.5-12.0)	2.54 (0.25-3.25)	4.18	7.0	4.4	A+	
9	12	24	-	-	2.12	2.83	5.65	-	-	10.60 (3.5-12.0)	2.54 (0.25-3.25)	4.18	7.0	4.4	A+	
9	14	14	-	-	2.58	4.01	4.01	-	-	10.60 (3.5-12.0)	2.54 (0.25-3.25)	4.18	7.0	4.4	A+	
9	14	18	-	-	2.33	3.62	4.65	-	-	10.60 (3.5-12.0)	2.54 (0.25-3.25)	4.18	7.0	4.4	A+	
9	14	22	-	-	2.12	3.30	5.18	-	-	10.60 (3.5-12.0)	2.54 (0.25-3.25)	4.18	7.0	4.4	A+	
9	14	24	-	-	2.03	3.16	5.41	-	-	10.60 (3.5-12.0)	2.54 (0.25-3.25)	4.18	7.0	4.4	A+	
9	18	18	-	-	2.12	4.44	4.44	-	-	10.60 (3.5-12.0)	2.54 (0.25-3.25)	4.18	7.0	4.4	A+	
9	18	22	-	-	1.95	3.89	4.76	-	-	10.60 (3.5-12.0)	2.54 (0.25-3.25)	4.18	7.0	4.4	A+	
9	18	24	-	-	1.87	3.74	4.99	-	-	10.60 (3.5-12.0)	2.54 (0.25-3.25)	4.18	7.0	4.4	A+	
12	12	12	-	-	3.53	3.53	3.53	-	-	10.60 (3.5-12.0)	2.54 (0.25-3.25)	4.18	7.0	4.4	A+	
12	12	14	-	-	3.35	3.35	3.90	-	-	10.60 (3.5-12.0)	2.54 (0.25-3.25)	4.18	7.0	4.4	A+	
12	12	18	-	-	3.03	3.03	4.54	-	-	10.60 (3.5-12.0)	2.54 (0.25-3.25)	4.18	7.0	4.4	A+	
12	12	22	-	-	2.77	2.77	5.06	-	-	10.60 (3.5-12.0)	2.54 (0.25-3.25)	4.18	7.0	4.4	A+	
12	12	24	-	-	2.65	2.65	5.30	-	-	10.60 (3.5-12.0)	2.54 (0.25-3.25)	4.18	7.0	4.4	A+	
12	14	14	-	-	3.18	3.71	3.71	-	-	10.60 (3.5-12.0)	2.54 (0.25-3.25)	4.18	7.0	4.4	A+	
12	14	18	-	-	2.89	3.37	4.34	-	-	10.60 (3.5-12.0)	2.54 (0.25-3.25)	4.18	7.0	4.4	A+	
12	14	22	-	-	2.65	3.09	4.86	-	-	10.60 (3.5-12.0)	2.54 (0.25-3.25)	4.18	7.0	4.4	A+	
12	14	24	-	-	2.54	2.97	5.09	-	-	10.60 (3.5-12.0)	2.54 (0.25-3.25)	4.18	7.0	4.4	A+	
12	18	18	-	-	2.64	3.98	3.98	-	-	10.60 (3.5-12.0)	2.54 (0.25-3.25)	4.18	7.0	4.4	A+	
12	18	22	-	-	2.45	3.67	4.48	-	-	10.60 (3.5-12.0)	2.54 (0.25-3.25)	4.18	7.0	4.4	A+	
12	18	24	-	-	2.36	3.53	4.71	-	-	10.60 (3.5-12.0)	2.54 (0.25-3.25)	4.18	7.0	4.4	A+	
14	14	14	-	-	3.53	3.53	3.53	-	-	10.60 (3.5-12.0)	2.54 (0.25-3.25)	4.18	7.0	4.4	A+	
14	14	18	-	-	3.23	3.23	4.14	-	-	10.60 (3.5-12.0)	2.54 (0.25-3.25)	4.18	7.0	4.4	A+	
14	14	22	-	-	2.97	2.97	4.66	-	-	10.60 (3.5-12.0)	2.54 (0.25-3.25)	4.18	7.0	4.4	A+	
14	14	24	-	-	2.89	2.85	4.90	-	-	10.60 (3.5-12.0)	2.54 (0.25-3.25)	4.18	7.0	4.4	A+	
14	18	18	-	-	2.98	3.82	3.82	-	-	10.60 (3.5-12.0)	2.54 (0.25-3.25)	4.18	7.0	4.4	A+	
18	18	18	-	-	3.53	3.53	3.53	-	-	10.60 (3.5-12.0)	2.54 (0.25-3.25)	4.18	7.0	4.4	A+	
7	7	7	7	-	2.40	2.40	2.40	2.40	-	9.60 (3.5-11.2)	2.17 (0.25-2.87)	4.42	6.5	4.6	A++	
7	7	7	9	-	2.40	2.40	2.40	3.00	-	10.20 (3.5-12.0)	2.33 (0.25-3.25)	4.37	6.8	4.5	A+	
7	7	7	12	-	2.25	2.25	2.25	3.85	-	10.60 (3.5-12.0)	2.44 (0.25-3.25)	4.34	7.0	4.5	A+	
7	7	7	14	-	2.12	2.12	2.12	4.24	-	10.60 (3.5-12.0)	2.44 (0.25-3.25)	4.34	7.0	4.5	A+	
7	7	7	18	-	1.90	1.90	1.90	4.90	-	10.60 (3.5-12.0)	2.44 (0.25-3.25)	4.34	7.0	4.5	A+	
7	7	7	22	-	1.73	1.73	1.73	5.41	-	10.60 (3.5-12.0)	2.44 (0.25-3.25)	4.34	7.0	4.5	A+	
7	7	7	24	-	1.65	1.65	1.65	5.65	-	10.60 (3.5-12.0)	2.44 (0.25-3.25)	4.34	7.0	4.5	A+	
7	7	9	9	-	2.32	2.32	2.98	2.98	-	10.60 (3.5-12.0)	2.40 (0.25-3.25)	4.34	7.0	4.5	A+	
7	7	9	12	-	2.12	2.12	2.73	3.63	-	10.60 (3.5-12.0)	2.44 (0.25-3.25)	4.34	7.0	4.5	A+	
7	7	9	14	-	2.01	2.01	2.57	4.01	-	10.60 (3.5-12.0)	2.44 (0.25-3.25)	4.34	7.0			



6-unit Multi-split Combination Table-Cooling

6-unit Multi-split cooling

ADHG45LBLE6	Combination of Indoor Units						Cooling Operation					Input Power (Min. - Max.)	EER	
							Cooling Capacity							Total Capacity (Min. - Max.)
							Unit 1	Unit 2	Unit 3	Unit 4	Unit 5			
		kW	kW	kW	kW	kW	kW	kW	kW	kW	kW	kW		
2-unit connection	12	24	-	-	-	-	-	-	-	10.5 (3.5-11.5)	3.06 (0.8-3.32)	3.43		
	14	24	-	-	-	-	-	-	-	11.0 (3.5-12.1)	3.28 (0.8-3.70)	3.35		
	18	18	-	-	-	-	-	-	-	10.0 (3.5-11.5)	2.92 (0.8-3.32)	3.42		
	18	24	-	-	-	-	-	-	-	12.0 (3.5-13.4)	3.75 (0.8-4.46)	3.20		
	24	24	-	-	-	-	-	-	-	12.5 (3.5-14.0)	4.01 (0.8-4.84)	3.12		
	7	7	24	-	-	-	-	-	-	3.19 (0.8-3.70)	0.95 (0.3-1.08)	3.65		
	7	9	18	-	-	-	-	-	-	2.55 (0.8-2.93)	0.75 (0.3-0.83)	3.73		
	7	9	24	-	-	-	-	-	-	11.5 (3.5-12.7)	3.41 (0.8-4.08)	3.37		
	7	12	18	-	-	-	-	-	-	10.5 (3.5-11.8)	3.02 (0.8-3.51)	3.48		
	7	12	24	-	-	-	-	-	-	12.4 (3.5-13.7)	3.82 (0.8-4.65)	3.25		
	7	14	14	-	-	-	-	-	-	10.0 (3.5-11.1)	2.81 (0.8-3.13)	3.56		
	3-unit connection	7	14	18	-	-	-	-	-	-	3.23 (0.8-3.89)	0.95 (0.3-1.08)	3.41	
7		14	24	-	-	-	-	-	-	12.5 (3.5-14.0)	3.89 (0.8-4.84)	3.21		
9		14	18	-	-	-	-	-	-	3.45 (0.8-4.27)	1.05 (0.4-1.15)	3.33		
9		14	24	-	-	-	-	-	-	12.5 (3.5-14.0)	3.88 (0.8-4.84)	3.23		
9		18	18	-	-	-	-	-	-	12.5 (3.5-14.0)	3.83 (0.8-4.84)	3.26		
9		9	18	-	-	-	-	-	-	10.0 (3.5-11.5)	2.84 (0.8-3.32)	3.52		
9		9	24	-	-	-	-	-	-	12.0 (3.5-13.4)	3.65 (0.8-4.46)	3.29		
9		12	14	-	-	-	-	-	-	10.0 (3.5-11.1)	2.81 (0.8-3.13)	3.56		
9		12	18	-	-	-	-	-	-	11.0 (3.5-12.4)	3.23 (0.8-3.89)	3.41		
9		12	24	-	-	-	-	-	-	12.5 (3.5-14.0)	3.89 (0.8-4.84)	3.21		
9		14	14	-	-	-	-	-	-	10.5 (3.5-11.8)	3.02 (0.8-3.51)	3.48		
4-unit connection		9	14	18	-	-	-	-	-	-	3.45 (0.8-4.27)	1.05 (0.4-1.15)	3.33	
	9	14	24	-	-	-	-	-	-	12.5 (3.5-14.0)	3.88 (0.8-4.84)	3.23		
	9	18	18	-	-	-	-	-	-	12.5 (3.5-14.0)	3.89 (0.8-4.84)	3.21		
	9	18	24	-	-	-	-	-	-	12.5 (3.5-14.0)	3.89 (0.8-4.84)	3.21		
	9	24	24	-	-	-	-	-	-	12.5 (3.5-14.0)	3.86 (0.8-4.84)	3.24		
	12	12	12	-	-	-	-	-	-	10.5 (3.5-11.5)	2.98 (0.8-3.32)	3.52		
	12	12	14	-	-	-	-	-	-	11.0 (3.5-12.1)	3.19 (0.8-3.70)	3.45		
	12	12	18	-	-	-	-	-	-	12.0 (3.5-13.4)	3.65 (0.8-4.46)	3.29		
	12	12	24	-	-	-	-	-	-	12.5 (3.5-14.0)	3.87 (0.8-4.84)	3.23		
	12	14	14	-	-	-	-	-	-	11.5 (3.5-12.7)	3.41 (0.8-4.08)	3.37		
	12	14	18	-	-	-	-	-	-	12.5 (3.5-14.0)	3.89 (0.8-4.84)	3.21		
	12	14	24	-	-	-	-	-	-	12.5 (3.5-14.0)	3.86 (0.8-4.84)	3.24		
12	18	18	-	-	-	-	-	-	12.5 (3.5-14.0)	3.87 (0.8-4.84)	3.23			
12	18	24	-	-	-	-	-	-	12.5 (3.5-14.0)	3.85 (0.8-4.84)	3.25			
12	24	24	-	-	-	-	-	-	12.5 (3.5-14.0)	3.81 (0.8-4.84)	3.28			
14	14	14	-	-	-	-	-	-	12.0 (3.5-13.4)	3.65 (0.8-4.46)	3.29			
14	14	18	-	-	-	-	-	-	12.5 (3.5-14.0)	3.88 (0.8-4.84)	3.22			
14	14	24	-	-	-	-	-	-	12.5 (3.5-14.0)	3.85 (0.8-4.84)	3.25			
14	18	18	-	-	-	-	-	-	12.5 (3.5-14.0)	3.85 (0.8-4.84)	3.25			
14	18	24	-	-	-	-	-	-	12.5 (3.5-14.0)	3.85 (0.8-4.84)	3.25			
14	24	24	-	-	-	-	-	-	12.5 (3.5-14.0)	3.83 (0.8-4.84)	3.26			
14	24	24	-	-	-	-	-	-	12.5 (3.5-14.0)	3.80 (0.8-4.84)	3.29			
18	18	18	-	-	-	-	-	-	12.5 (3.5-14.0)	3.85 (0.8-4.84)	3.25			
18	18	24	-	-	-	-	-	-	12.5 (3.5-14.0)	3.81 (0.8-4.84)	3.28			
7	7	7	14	-	-	-	-	-	10.0 (3.5-11.1)	2.50 (0.8-3.13)	4.00			
7	7	7	18	-	-	-	-	-	11.0 (3.5-12.4)	3.06 (0.8-3.89)	3.59			
7	7	7	24	-	-	-	-	-	12.5 (3.5-14.0)	3.77 (0.8-4.84)	3.32			
7	7	9	12	-	-	-	-	-	10.0 (3.5-11.1)	2.50 (0.8-3.13)	4.00			
7	7	9	18	-	-	-	-	-	10.5 (3.5-11.8)	2.79 (0.8-3.27)	3.76			
7	7	9	24	-	-	-	-	-	11.5 (3.5-13.0)	3.33 (0.8-4.27)	3.45			
7	7	9	12	-	-	-	-	-	12.5 (3.5-14.0)	3.75 (0.8-4.84)	3.33			
7	7	12	12	-	-	-	-	-	11.0 (3.5-12.1)	3.00 (0.8-3.70)	3.67			
7	7	12	14	-	-	-	-	-	11.5 (3.5-12.7)	3.27 (0.8-4.08)	3.52			
7	7	12	18	-	-	-	-	-	12.5 (3.5-14.0)	3.78 (0.8-4.84)	3.31			
7	7	12	24	-	-	-	-	-	12.5 (3.5-14.0)	3.74 (0.8-4.84)	3.34			
7	7	14	14	-	-	-	-	-	12.0 (3.5-13.4)	3.51 (0.8-4.46)	3.42			
7	7	14	18	-	-	-	-	-	12.5 (3.5-14.0)	3.77 (0.8-4.84)	3.32			
7	7	14	24	-	-	-	-	-	12.5 (3.5-14.0)	3.73 (0.8-4.84)	3.35			
7	7	18	18	-	-	-	-	-	12.5 (3.5-14.0)	3.74 (0.8-4.84)	3.34			
7	7	18	24	-	-	-	-	-	12.5 (3.5-14.0)	3.70 (0.8-4.84)	3.38			
7	7	24	24	-	-	-	-	-	12.5 (3.5-14.0)	3.67 (0.8-4.84)	3.41			
7	9	9	9	-	-	-	-	-	9.5 (3.5-10.8)	2.31 (0.8-2.93)	4.11			
7	9	9	12	-	-	-	-	-	10.5 (3.5-11.8)	2.79 (0.8-3.51)	3.76			
7	9	9	14	-	-	-	-	-	11.0 (3.5-12.4)	3.06 (0.8-3.89)	3.59			
7	9	9	18	-	-	-	-	-	12.0 (3.5-13.4)	3.57 (0.8-4.65)	3.36			
7	9	9	24	-	-	-	-	-	12.5 (3.5-14.0)	3.74 (0.8-4.84)	3.34			
7	9	12	12	-	-	-	-	-	11.5 (3.5-12.7)	3.27 (0.8-4.08)	3.52			
7	9	12	14	-	-	-	-	-	12.0 (3.5-13.4)	3.50 (0.8-4.27)	3.40			
7	9	12	18	-	-	-	-	-	12.5 (3.5-14.0)	3.50 (0.8-4.27)	3.40			
7	9	12	24	-	-	-	-	-	12.5 (3.5-14.0)	3.50 (0.8-4.27)	3.40			
7	9	12	18	-	-	-	-	-	12.5 (3.5-14.0)	3.77 (0.8-4.84)	3.32			
7	9	12	14	-	-	-	-	-	12.5 (3.5-14.0)	3.73 (0.8-4.84)	3.35			
7	9	12	12	-	-	-	-	-	12.5 (3.5-14.0)	3.77 (0.8-4.84)	3.32			
7	9	12	12	-	-	-	-	-	12.5 (3.5-14.0)	3.73 (0.8-4.84)	3.35			
7	9	12	12	-	-	-	-	-	12.5 (3.5-14.0)	3.78 (0.8-4.84)	3.31			
7	9	12	12	-	-	-	-	-	12.5 (3.5-14.0)	3.75 (0.8-4.84)	3.33			
7	9	12	12	-	-	-	-	-	12.5 (3.5-14.0)	3.71 (0.8-4.84)	3.37			
7	9	12	12	-	-	-	-	-	12.5 (3.5-14.0)	3.75 (0.8-4.84)	3.33			
7	9	12	12	-	-	-	-	-	12.5 (3.5-14.0)	3.73 (0.8-4.84)	3.35			
7	9	12	12	-	-	-	-	-	12.5 (3.5-14.0)	3.71 (0.8-4.84)	3.37			
7	9	12	12	-	-	-	-	-	12.5 (3.5-14.0)	3.75 (0.8-4.84)	3.33			
7	9	12	12	-	-	-	-	-	12.5 (3.5-14.0)	3.73 (0.8-4.84)	3.35			
7	9	12	12	-	-	-	-	-	12.5 (3.5-14.0)	3.71 (0.8-4.84)	3.37			
7	9	12	12	-	-	-	-	-	12.5 (3.5-14.0)	3.75 (0.8-4.84)	3.33			
7	9	12	12	-	-	-	-	-	12.5 (3.5-14.0)	3.73 (0.8-4.84)	3.35			
7	9	12	12	-	-	-	-	-	12.5 (3.5-14.0)	3.71 (0.8-4.84)	3.37			
7	9	12	12	-	-	-	-	-	12.5 (3.5-14.0)	3.75 (0.8-4.84)	3.33			
7	9	12	12	-	-	-	-	-	12.5 (3.5-14.0)	3.73 (0.8-4.84)	3.35			
7	9	12	12	-	-	-	-	-	12.5 (3.5-14.0)	3.71 (0.8-4.84)	3.37			
7	9	12	12	-	-	-	-	-	12.5 (3.5-14.0)	3.75 (0.8-4.84)	3.33			
7	9	12	12	-	-	-	-	-	12.5 (3.5-14.0)	3.73 (0.8-4.84)	3.35			
7	9	12	12	-	-	-	-	-	12.5 (3.5-14.0)	3.71 (0.8-4.84)	3.37			
7	9	12	12	-	-	-	-	-	12.5 (3.5-14.0)	3.75 (0.8-4.84)	3.33			
7	9	12	12	-	-	-	-	-	12.5 (3.5-14.0)	3.73 (0.8-4.84)	3.35			
7	9	12	12	-	-	-	-	-	12.5 (3.5-14.0)	3.71 (0.8-4.84)	3.37			
7	9	12	12	-	-	-	-	-	12.5 (3.5-14.0)	3.75 (0.8-4.84)	3.33			
7	9	12	12	-	-	-	-	-	12.5 (3.5-14.0)	3.73 (0.8-4.84)	3.35			
7	9	12	12	-	-	-	-	-	12.5 (3.5-14.0)	3.71 (0.8-4.84)	3.37			
7	9	12	12	-	-	-	-	-	12.5 (3.5-14.0)	3.75 (0.8-4.84)	3.33			
7	9	12	12	-	-	-	-	-	12.5 (3.5-14.0)	3.73 (0.8-4.84)	3.35			
7	9	12	12	-	-	-	-	-	12.5 (3.5-14.0)	3.71 (0.8-4.84)	3.37			
7	9	12	12	-	-	-								

6-unit Multi-split Multi Combination Table-Cooling/Heating

6-unit Multi-split cooling

ADHG45LBLA6	Combination of Indoor Units							Cooling Operation									
								Cooling Capacity							Input Power (Min. - Max.)	EER	
								Unit 1	Unit 2	Unit 3	Unit 4	Unit 5	Unit 6	Total Capacity (Min. - Max.)			
	7	7	7	7	7	7	7	2.00	2.00	2.00	2.00	2.00	2.00	2.00	12.0 (3.5-13.4)	3.32 (0.8-4.46)	3.61

- Notes: •7: 7000 Btu/h/9: 9000 Btu/h/12: 12000 Btu/h/14: 14000 Btu/h/18: 18000 Btu/h/24: 24000 Btu/h models
- The above specifications apply when connected with a wall-mounted unit.
 - 2 or more indoor units should be connected.
 - Cooling capacity is determined based on 27°CDB/19°CWB (indoor temperature) and 35°CDB (outdoor temperature).
 - Pipe Length: 5 m, Height difference: 0 m (Outdoor unit to Indoor unit)
 - Total capacity of indoor units connected must be between 9.5 kW and 18.0 kW.

6-unit Multi-split heating

ADHG45LBLA6	Combination of Indoor Units							Heating Operation									
								Heating Capacity							Input Power (Min. - Max.)	COP	
								Unit 1	Unit 2	Unit 3	Unit 4	Unit 5	Unit 6	Total Capacity (Min. - Max.)			
	12	24	-	-	-	-	-	4.07	8.13	-	-	-	-	-	12.2 (3.5-13.1)	3.41 (0.7-3.54)	3.58

6-unit Multi-split Combination Table-Heating

6-unit Multi-split heating

ADHG45LBLA6	Combination of Indoor Units		Heating Operation						Input Power (Min. - Max.)	COP					
			Heating Capacity												
			Unit 1	Unit 2	Unit 3	Unit 4	Unit 5	Unit 6			Total Capacity (Min. - Max.)				
		kW						kW							
4-unit connection	12	12	12	12	-	-	3.38	3.38	3.38	3.38	-	-	13.5 (3.5-16.0)	3.60 (0.7-4.4)	3.75
	12	12	12	14	-	-	3.24	3.24	3.24	3.78	-	-	13.5 (3.5-16.0)	3.60 (0.7-4.4)	3.75
	12	12	12	18	-	-	3.00	3.00	3.00	4.50	-	-	13.5 (3.5-16.0)	3.58 (0.7-4.4)	3.77
	12	12	12	24	-	-	2.70	2.70	2.70	5.40	-	-	13.5 (3.5-16.0)	3.57 (0.7-4.4)	3.78
	12	12	14	14	-	-	3.12	3.12	3.63	3.63	-	-	13.5 (3.5-16.0)	3.59 (0.7-4.4)	3.76
	12	12	14	18	-	-	2.89	2.89	3.38	4.34	-	-	13.5 (3.5-16.0)	3.58 (0.7-4.4)	3.77
	12	12	14	24	-	-	2.61	2.61	3.05	5.23	-	-	13.5 (3.5-16.0)	3.56 (0.7-4.4)	3.79
	12	12	18	18	-	-	2.70	2.70	4.05	4.05	-	-	13.5 (3.5-16.0)	3.57 (0.7-4.4)	3.78
	12	14	14	14	-	-	3.00	3.50	3.50	3.50	-	-	13.5 (3.5-16.0)	3.58 (0.7-4.4)	3.77
	12	14	14	18	-	-	2.79	3.26	3.26	4.19	-	-	13.5 (3.5-16.0)	3.57 (0.7-4.4)	3.78
	12	14	18	18	-	-	2.61	3.05	3.92	3.92	-	-	13.5 (3.5-16.0)	3.56 (0.7-4.4)	3.79
	7	7	7	7	7	7	2.40	2.40	2.40	2.40	2.40	-	12.0 (3.5-12.7)	2.82 (0.7-3.44)	4.26
7	7	7	7	9	-	2.33	2.33	2.33	2.98	-	-	12.3 (3.5-13.5)	3.03 (0.7-3.65)	4.06	
7	7	7	7	12	-	2.10	2.10	2.10	3.60	-	-	12.8 (3.5-14.5)	3.29 (0.7-3.98)	3.89	
7	7	7	7	14	-	2.20	2.20	2.20	4.40	-	-	13.2 (3.5-15.3)	3.40 (0.7-4.20)	3.88	
7	7	7	7	18	-	2.05	2.05	2.05	5.30	-	-	13.5 (3.5-16.0)	3.49 (0.7-4.4)	3.87	
7	7	7	7	24	-	1.82	1.82	1.82	6.22	-	-	13.5 (3.5-16.0)	3.47 (0.7-4.4)	3.89	
7	7	7	9	9	-	2.28	2.28	2.28	2.93	2.93	-	12.7 (3.5-14.2)	3.23 (0.7-3.87)	3.93	
7	7	7	9	12	-	2.20	2.20	2.20	2.83	3.77	-	13.2 (3.5-15.3)	3.40 (0.7-4.20)	3.88	
7	7	7	9	14	-	2.15	2.15	2.15	2.76	4.29	-	13.5 (3.5-16.0)	3.49 (0.7-4.4)	3.87	
7	7	7	9	18	-	1.97	1.97	1.97	2.53	5.06	-	13.5 (3.5-16.0)	3.48 (0.7-4.4)	3.88	
7	7	7	9	24	-	1.75	1.75	1.75	2.25	6.00	-	13.5 (3.5-16.0)	3.46 (0.7-4.4)	3.90	
7	7	7	12	12	-	2.01	2.01	2.01	3.60	-	-	13.5 (3.5-16.0)	3.49 (0.7-4.4)	3.89	
7	7	7	12	14	-	2.01	2.01	3.45	4.02	-	-	13.5 (3.5-16.0)	3.48 (0.7-4.4)	3.88	
7	7	7	12	18	-	1.85	1.85	1.85	3.18	4.77	-	13.5 (3.5-16.0)	3.47 (0.7-4.4)	3.89	
7	7	7	12	24	-	1.66	1.66	1.66	2.84	5.68	-	13.5 (3.5-16.0)	3.45 (0.7-4.4)	3.91	
7	7	7	14	14	-	1.93	1.93	1.93	3.86	3.86	-	13.5 (3.5-16.0)	3.48 (0.7-4.4)	3.88	
7	7	7	14	18	-	1.78	1.78	1.78	3.57	4.59	-	13.5 (3.5-16.0)	3.47 (0.7-4.4)	3.89	
7	7	7	14	24	-	1.60	1.60	1.60	3.20	5.50	-	13.5 (3.5-16.0)	3.45 (0.7-4.4)	3.91	
7	7	7	18	18	-	1.66	1.66	1.66	4.26	4.26	-	13.5 (3.5-16.0)	3.45 (0.7-4.4)	3.91	
7	7	7	9	9	9	2.22	2.22	2.85	2.85	2.85	-	13.0 (3.5-14.9)	3.34 (0.7-4.09)	3.89	
7	7	9	9	12	-	2.15	2.15	2.76	3.68	-	-	13.5 (3.5-16.0)	3.49 (0.7-4.4)	3.88	
7	7	9	9	14	-	2.05	2.05	2.64	4.12	-	-	13.5 (3.5-16.0)	3.49 (0.7-4.4)	3.87	
7	7	9	9	18	-	1.89	1.89	2.43	4.86	-	-	13.5 (3.5-16.0)	3.48 (0.7-4.4)	3.88	
7	7	9	9	24	-	1.69	1.69	2.17	5.78	-	-	13.5 (3.5-16.0)	3.46 (0.7-4.4)	3.90	
7	7	9	12	12	-	2.01	2.01	2.58	3.45	3.45	-	13.5 (3.5-16.0)	3.48 (0.7-4.4)	3.88	
7	7	9	12	14	-	1.93	1.93	2.48	3.31	3.85	-	13.5 (3.5-16.0)	3.48 (0.7-4.4)	3.88	
7	7	9	12	18	-	1.78	1.78	2.29	3.06	4.59	-	13.5 (3.5-16.0)	3.47 (0.7-4.4)	3.89	
7	7	9	12	24	-	1.60	1.60	2.06	2.75	5.49	-	13.5 (3.5-16.0)	3.45 (0.7-4.4)	3.91	
7	7	9	14	14	-	1.85	1.85	2.38	3.71	3.71	-	13.5 (3.5-16.0)	3.47 (0.7-4.4)	3.89	
7	7	9	14	18	-	1.72	1.72	2.21	3.44	4.41	-	13.5 (3.5-16.0)	3.46 (0.7-4.4)	3.90	
7	7	9	14	24	-	1.55	1.55	1.99	3.10	5.31	-	13.5 (3.5-16.0)	3.44 (0.7-4.4)	3.92	
7	7	9	18	18	-	1.60	1.60	2.06	4.12	4.12	-	13.5 (3.5-16.0)	3.45 (0.7-4.4)	3.91	
7	7	12	12	12	-	1.89	1.89	3.24	3.24	3.24	-	13.5 (3.5-16.0)	3.48 (0.7-4.4)	3.88	
7	7	12	12	14	-	1.82	1.82	3.12	3.62	3.62	-	13.5 (3.5-16.0)	3.47 (0.7-4.4)	3.89	
7	7	12	12	18	-	1.69	1.69	2.89	4.34	4.34	-	13.5 (3.5-16.0)	3.46 (0.7-4.4)	3.90	
7	7	12	12	24	-	1.52	1.52	2.61	5.24	5.24	-	13.5 (3.5-16.0)	3.44 (0.7-4.4)	3.92	
7	7	12	14	14	-	1.75	1.75	3.00	3.50	3.50	-	13.5 (3.5-16.0)	3.46 (0.7-4.4)	3.90	
7	7	12	14	18	-	1.63	1.63	2.79	3.26	4.19	-	13.5 (3.5-16.0)	3.45 (0.7-4.4)	3.91	
7	7	12	18	18	-	1.52	1.52	2.62	3.92	3.92	-	13.5 (3.5-16.0)	3.44 (0.7-4.4)	3.92	
7	7	14	14	14	-	1.68	1.68	3.38	3.38	3.38	-	13.5 (3.5-16.0)	3.46 (0.7-4.4)	3.90	
7	7	14	14	18	-	1.58	1.58	3.15	3.15	4.04	-	13.5 (3.5-16.0)	3.45 (0.7-4.4)	3.91	
7	9	9	9	9	-	2.18	2.18	2.78	2.78	2.78	-	13.3 (3.5-15.6)	3.44 (0.7-4.30)	3.87	
7	9	9	9	12	-	2.05	2.64	2.64	2.64	3.53	-	13.5 (3.5-16.0)	3.49 (0.7-4.4)	3.87	
7	9	9	9	14	-	1.97	2.53	2.53	2.53	3.94	-	13.5 (3.5-16.0)	3.48 (0.7-4.4)	3.88	
7	9	9	9	18	-	1.82	2.34	2.34	2.34	4.66	-	13.5 (3.5-16.0)	3.47 (0.7-4.4)	3.89	
7	9	9	9	24	-	1.63	2.09	2.09	2.09	5.60	-	13.5 (3.5-16.0)	3.45 (0.7-4.4)	3.91	
7	9	9	12	12	-	1.92	2.48	2.48	3.31	3.31	-	13.5 (3.5-16.0)	3.48 (0.7-4.4)	3.88	
7	9	9	12	18	-	1.72	2.38	2.38	3.18	3.71	-	13.5 (3.5-16.0)	3.47 (0.7-4.4)	3.89	
7	9	9	12	24	-	1.55	2.21	2.21	2.95	4.41	-	13.5 (3.5-16.0)	3.46 (0.7-4.4)	3.90	
7	9	9	14	14	-	1.55	1.99	1.99	2.66	5.31	-	13.5 (3.5-16.0)	3.44 (0.7-4.4)	3.92	
7	9	9	14	18	-	1.78	2.29	2.29	3.57	3.57	-	13.5 (3.5-16.0)	3.47 (0.7-4.4)	3.89	
7	9	9	14	24	-	1.66	2.13	2.13	3.32	4.26	-	13.5 (3.5-16.0)	3.45 (0.7-4.4)	3.91	
7	9	9	18	18	-	1.56	1.99	1.99	3.98	3.98	-	13.5 (3.5-16.0)	3.44 (0.7-4.4)	3.92	
7	9	12	12	12	-	1.82	2.32	3.12	3.12	3.12	-	13.5 (3.5-16.0)	3.47 (0.7-4.4)	3.89	
7	9	12	12	14	-	1.75	2.25	3.00	3.00	3.50	-	13.5 (3.5-16.0)	3.46 (0.7-4.4)	3.90	
7	9	12	12	18	-	1.63	2.09	2.79	2.79	4.20	-	13.5 (3.5-16.0)	3.45 (0.7-4.4)	3.91	
7	9	12	14	14	-	1.69	2.17	2.88	3.38	3.38	-	13.5 (3.5-16.0)	3.46 (0.7-4.4)	3.90	
7	9	12	14	18	-	1.58	2.03	2.70	3.15	4.04	-	13.5 (3.5-16.0)	3.45 (0.7-4.4)	3.91	
7	9	14	14	14	-	1.63	2.09	3.26	3.26	3.26	-	13.5 (3.5-16.0)	3.45 (0.7-4.4)	3.91	
7	9	14	14	18	-	1.52	1.96	3.05	3.05	3.92	-	13.5 (3.5-16.0)	3.44 (0.7-4.4)	3.92	
7	12	12	12	12	-	1.70	2.95	2.95	2.95	2.95	-	13.5 (3.5-16.0)	3.46 (0.7-4.4)	3.90	
7	12	12	12	14	-	1.66	2.84	2.84	2.84	3.32	-	13.5 (3.5-16.0)	3.45 (0.7-4.4)	3.91	
7	12	12	12	18	-	1.55	2.66	2.66	2.66	3.97	-	13.5 (3.5-16.0)	3.44 (0.7-4.4)	3.92	
7	12	12	14	14	-	1.60	2.75	2.75	3.20	3.20	-	13.5 (3.5-16.0)	3.45 (0.7-4.4)	3.91	
7	12	14	14	14	-	1.55	2.65	3.10	3.10	3.10	-	13.5 (3.5-16.0)	3.44 (0.7-4.4)	3.92	
9	9	9	9	9	-	2.70	2.70	2.70	2.70	2.70	-	13.5 (3.5-16.0)	3.49 (0.7-4.4)	3.87	
9	9	9	9	12	-	2.53	2.53	2.53	2.53	3.38	-	13.5 (3.5-16.0)	3.48 (0.7-4.4)	3.88	
9	9	9	9	14	-	2.43	2.43	2.43	2.43	3.78	-	13.5 (3.5-16.0)	3.48 (0.7-4.4)	3.88	
9	9	9	9	18	-	2.25	2.25	2.25	2.25	4.50	-	13.5 (3.5-16.0)	3.46 (0.7-4.4)	3.90	
9	9	9	9	24	-	2.03	2.03	2.03	2.03	5.38	-	13.5 (3.5-16.0)	3.45 (0.7-4.4)	3.91	
9	9	9	12	12	-	2.38	2.38	2.38	3.18	3.18	-	13.5 (3.5-16.0)	3.47 (0.7-4.4)	3.89	
9	9	9	12	14	-	2.29	2.29	2.29	3.06	3.57	-	13.5 (3.5-16.0)	3.47 (0.7-4.4)	3.89	
9	9	9	12	18	-	2.13	2.13	2.13	2.84	4.27	-	13.5 (3.5-16.0)	3.45 (0.7-4.4)	3.91	
9	9	9	14	14	-	2.21	2.21	2.21	3.44	3.44	-	13.5 (3.5-16.0)	3.46 (0.7-4.4)	3.90	
9	9	9	14	18	-	2.06	2.06	2.06	3.20	4.12	-	13.5 (3.5-16.0)	3.45 (0.7-4.4)	3.91	
9	9	12	12	12	-	2.25	2.25	3.00	3.00	3.00	-	13.5 (3.5-16.0)	3.46 (0.7-4.4)	3.90	
9	9	12	12	14	-	2.17	2.17	2.89	2.89	3.38	-	13.5 (3.5-16.0)	3.46 (0.7-4.4)	3.90	
9	9	12	12	18	-										

Feature Summary

Type	Wall-mounted type								Cassette		Duct						Floor		Floor/Ceiling	Ceiling				
	Designer Series		Standard Series		Designer Series	Standard Series		Compact 4-way Flow Grid type Series	Compact 4-way Flow Series	4-way Flow Series	Mini (With drain pump)		Slim (With drain pump)		Medium Static Pressure									
Series	ASHG 07/09/12/14 KGTG	ASHG 07/09/12/14 KGTG	ASHG 07/09/12/14 KGTG	ASHG 07/09/12/14 KGTG	ASHG 07/09/12/14 KGTG	ASHG 07/09/12/14 KGTG	ASHG 07/09/12/14 KGTG	ASHG 07/09/12/14 KGTG	ASHG 07/09/12/14 KGTG	AUXG 07/09/12/14/18/22/24 KVLG	AUXG 07/09/12/14/18/22/24 KVLG	AUXG 07/09/12/14/18/22/24 KVLG	ARXG 07/09/12/14/18 KSLAP	ARHG 07/09/12/14/18 LSLAP	ARXG 07/09/12/14/18 KLLAP	ARHG 07/09/12/14/18 LLTB	ARXG 07/09/12/14/18 KLLAP	ARHG 07/09/12/14/18 LLTB	ARHG 22/24/36/45 LMLA, ARHG 30/36/LMLE	AGHG 09/12/14 KVCA	AGHG 09/12/14 LVCA	ABHG 14/22/24 LVTA, ABHG 18/LVVB	ABHG 18/22/KRTA	ABHG 30/36/LRTE, ABHG 36/45/LRTA
Model name																								
Refrigerant																								
Energy-saving Features	Save Occupancy sensor	●																						
	Economy operation	●	●	●	●	●	●	●	●	●	●	●	●	●	●	●	○	●	●	●	●	●	●	●
	Setting temperature range limitation	○	○	○	○	○	○	○	○	○	○	○	○	○	○	○	○	○	○	○	○	○	○	○
	Set temperature auto return	○	○	○	○	○	○	○	○	○	○	○	○	○	○	○	○	○	○	○	○	○	○	○
Features for Comfort	Power diffuser									●	●													
	Powerful operation	●	●	●	●	●	●	●	●	●	●	●	●	●	●	●	●	●	●	●	●	●	●	●
	10°C Heat	●	●	●	●	●	●	●	●	●	○	○	○	○	○	○	○	○	○	○	○	○	○	○
	Outdoor unit low noise operation	●	●	●	●	●	●	●	●	●	●	●	●	●	●	●	●	●	●	●	●	●	●	●
	Auto changeover	●	●	●	●	●	●	●	●	●	●	●	●	●	●	●	●	●	●	●	●	●	●	●
	UP/DOWN swing louver	●	●	●	●	●	●	●	●	●	●	○	○	○	○	○	○	○	○	○	○	○	○	○
	Double swing automatic																							
	Automatic fan speed	●	●	●	●	●	●	●	●	●	●	●	●	●	●	●	●	●	●	●	●	●	●	●
	Auto restart	●	●	●	●	●	●	●	●	●	●	●	●	●	●	●	●	●	●	●	●	●	●	●
	Connectable fresh air duct																							
	Fresh air intake										○	○												
	Connectable distributing duct																							
	Convenience Features	Auto-off timer	○	○	○	○	○	○	○	○	○	○	○	○	○	○	○	○	○	○	○	○	○	○
Sleep timer		●	●	●	●	●	●	●	●	●	●	●	●	●	●	●	●	●	●	●	●	●	●	●
Program timer		●	●	●	●	●	●	●	●	●	●	●	●	●	●	●	●	●	●	●	●	●	●	●
Weekly timer		●	●	○	●	●	●	●	●	●	●	●	●	●	●	●	●	●	●	●	●	●	●	●
Weekly & Temperature setback timer		○	○	○	○	○	○	○	○	○	○	○	○	○	○	○	○	○	○	○	○	○	○	○
Filter sign		●	●	●	●	●	●	●	●	●	●	●	●	●	●	●	●	●	●	●	●	●	●	●
External error output		○	○	○	○	○	○	○	○	○	○	○	○	○	○	○	○	○	○	○	○	○	○	○
External ON/OFF input		○	○	○	○	○	○	○	○	○	○	○	○	○	○	○	○	○	○	○	○	○	○	○
Clean Features	Wireless LAN control	●	●	●	○	○	○	○	○	○	○	○	○	○	○	○	○	○	○	○	○	○	○	
	Ion deodorization filter	●	●	●	●	●	●	●	●	●	●	●	●	●	●	●	●	●	●	●	●	●	●	
	Apple-catechin filter	●	●	●	●	●	●	●	●	●	●	●	●	●	●	●	●	●	●	●	●	●	●	
	Long-life filter																							
	Washable panel	●	●	●	●	●	●	●	●	●	●	●	●	●	●	●	●	●	●	●	●	●	●	●
Installation / Support	Silver Ion Filter	○	○	○	○	○	○	○	○	○	○	○	○	○	○	○	○	○	○	○	○	○	○	
	Automatic airflow adjustment																							
	Drain pump as standard																							
	Blue fin																							
Refrigerant cycle monitor																								

○ : Optional function

Light Commercial & Commercial, Residential VRF

VRF systems provide air conditioning solutions that meet the requirements of a diverse range of buildings.

VRF systems provide air conditioning solutions for large residences as well as large commercial buildings.

V-002 VRF J Series Overview
V-004 VRF V Series Overview
V-006 VRF Outdoor Units Lineup
V-008 Features

VRF Outdoor Units



VRF J Series Heat Pump for Small-Capacity Type

V-022 VRF J-IVL
V-028 VRF J-IV
V-032 VRF J-IVS



VRF V Series Heat Recovery Modular Type

V-036 VRF VR-IV

Heat Pump Modular Type

V-046 VRF V-IV

VRF INDOOR UNITS

V-054 VRF Indoor Units Lineup
V-056 VRF Indoor Units



VRF

Light Commercial
& Commercial,
Residential



FUJITSU GENERAL (Euro) GmbH participates in the ECP program for VRF. Check ongoing validity of certificate: www.eurovent-certification.com

FUJITSU GENERAL LIMITED

VRF J Series Overview

Fujitsu General provides air conditioning systems for a wide range of applications, from residences, small offices, hotels, to large retailers.



Maximum **18 HP** Heat Pump

VRF J-IVL

J-IVL is an outdoor unit with a slim design. Its flexibility in installation makes it ideal for midsize office buildings and hotels. With the newly added 14/16/18 HP models, up to 42 indoor units* are connectable, making them ideal for hospitals and educational facilities with many rooms.

*: 18 HP model

Slim Outdoor Unit

Although the new 14/16/18 HP models support slightly higher capacities, they have a slim depth of just 480 mm. This means they can be installed even in tight spaces.

Small room application

The optimum heat exchanger structure allows up to 20-42 indoor units to be connected to an outdoor unit, easily accommodating a number of small rooms

Class-leading Low Operating Sound

The top-class low operating noise makes it ideal for use in densely populated areas.

Maximum **6 HP** Heat Pump

VRF J-IV

J-IV is connectable with up to 14 indoor units, making it suitable for commercial facilities housing a number of small stores.

High energy efficiency

Heat pump inverter control achieves efficient cooling and heating operation for any combination of indoor units.

Flexible system configuration for small and midsize buildings

The space saving design and long pipe connection enable flexible installation on the roof or balcony of a small or midsize building. Multiple indoor units of various capacities and types can be connected.



Maximum **6 HP** Heat Pump, Compact Design

VRF J-IVS

The 998 mm compact design does not obstruct the view even when installed underneath a waist-high window, ideal for large houses and retail stores.

Spaces saving and low sound level design

Economical individual air conditioning is achieved by ALL-DC technology, large-capacity DC twin-rotary compressor, and 3-row heat exchanger, despite the compact size.

Flexible system configuration for homes, stores, and small buildings

The compact size and flexible pipe design make the J-IVS Series an ideal choice for installation in tight spaces in residences, stores, and small offices. Multiple indoor units of various capacities and types can be connected.



8/10/12 HP models

14/16/18 HP models

VRF V Series Overview

VRF V provides air conditioning solutions for large residences as well as large commercial buildings.



Maximum **48 HP** Heat Recovery

VRF **VR-IV**

Smart, cutting-edge design
Extensive lineup from 8 HP to 48 HP
with the capacity ratio of indoor units connectable up to 150%.

Simultaneous cooling and heating operation using a single refrigerant system

Cooling and heating operations can be selected individually for each indoor unit to provide a comfortable room environment in each room by accommodating widely varying temperatures requirements.

Annual cooling operation

Choose the annual cooling option for rooms and other spaces that require constant temperature control throughout the year.

Accommodating changes in temperature difference

When there are large temperature differences during the day, such as with the change of seasons, the operation mode can be readily changed between heating and cooling.

Maximum **48 HP** Heat Pump

VRF **V-IV**

Smart, cutting-edge design
Available in a wide range of models from 8 to 48 HP in 2 HP increments with the capacity ratio of indoor units connectable up to 150%.

Excellent energy saving

The inverter heat pump model achieves high energy savings for individual cooling or heating operation by making full use of inverter technology to achieve seasonal efficiency.

High design flexibility for placement in any building

Superb design flexibility meets the diverse installation needs of high-rise buildings for air conditioners, such as a concentrated rooftop installation of outdoor units combined with individual floor installation of indoor units. This flexibility is achieved by large-capacity combination, ample connection capacity, and high static pressure design.

Easy installation and maintenance

The flexible communication method and pipe connections make installation and maintenance easy—even for large systems.

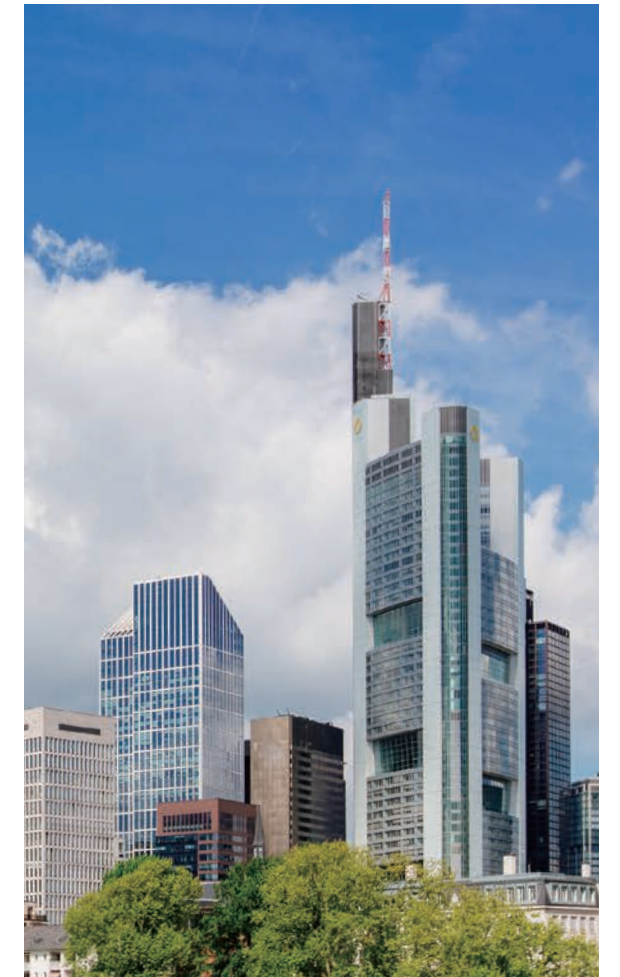

VRF Outdoor Units Lineup

Capacity (kW)		12.1	14.0	15.1-15.5	22.4	28.0	33.5	40.0	45.0	50.0-50.4	55.9	61.5	67.0	73.5	78.5	85.0	90.0	95.0	100.5	107.0	112.0	118.5	123.5	130.0	135.0	
HP		4	5	6	8	10	12	14	16	18	20	22	24	26	28	30	32	34	36	38	40	42	44	46	48	
J-IVL Series	Space Saving																									
	Set Model				AJH072 LELDH	AJH090 LELDH	AJH108 LELDH	AJH126 LELDH	AJH144 LELDH	AJH162 LELDH																
J-IV Series	Space Saving																									
	Set Model	AJH040 LBLDH, AJH040 LELDH	AJH045 LBLDH, AJH045 LELDH	AJH054 LBLDH, AJH054 LELDH																						
J-IVS Series	Space Saving																									
	Set Model	AJH040 LCLDH	AJH045 LCLDH	AJH054 LCLDH																						
VR-IV Series Heat Recovery	Space Saving																									
	Energy Efficiency																									
	Set Model							AJH144 GALDHH				AJH198 GALDHH	AJH216 GALDHH	AJH234 GALDHH	AJH252 GALDHH	AJH270 GALDHH	AJH288 GALDHH	AJH306 GALDHH	AJH324 GALDHH	AJH342 GALDHH	AJH360 GALDHH	AJH378 GALDHH	AJH396 GALDHH			
	Set Model				AJH072 GALDH	AJH090 GALDH	AJH108 GALDH	AJH126 GALDH	AJH144 GALDH	AJH162 GALDH	AJH180 GALDH	AJH198 GALDH	AJH216 GALDH	AJH234 GALDH	AJH252 GALDH	AJH270 GALDH	AJH288 GALDH	AJH306 GALDH	AJH324 GALDH	AJH342 GALDH	AJH360 GALDH	AJH378 GALDH	AJH396 GALDH	AJH414 GALDH	AJH432 GALDH	
V-IV Series Heat Pump	Space Saving																									
	Energy Efficiency																									
	Set Model				AJH072 LALDH	AJH090 LALDH	AJH108 LALDH	AJH126 LALDH	AJH144 LALDH	AJH162 LALDH	AJH180 LALDH	AJH198 LALDH	AJH216 LALDH	AJH234 LALDH	AJH252 LALDH	AJH270 LALDH	AJH288 LALDH	AJH306 LALDH	AJH324 LALDH	AJH342 LALDH	AJH360 LALDH	AJH378 LALDH	AJH396 LALDH	AJH414 LALDH	AJH432 LALDH	
	Set Model								AJH144 LALDHH		AJH180 LALDHH		AJH216 LALDHH	AJH234 LALDHH	AJH252 LALDHH	AJH270 LALDHH	AJH288 LALDHH	AJH306 LALDHH	AJH324 LALDHH	AJH342 LALDHH	AJH360 LALDHH	AJH378 LALDHH	AJH396 LALDHH			



Features

High-efficiency

High-efficiency is achieved significantly by the use of a DC twin-rotary compressor, inverter technology, and a large heat exchanger.



DC twin-rotary compressor

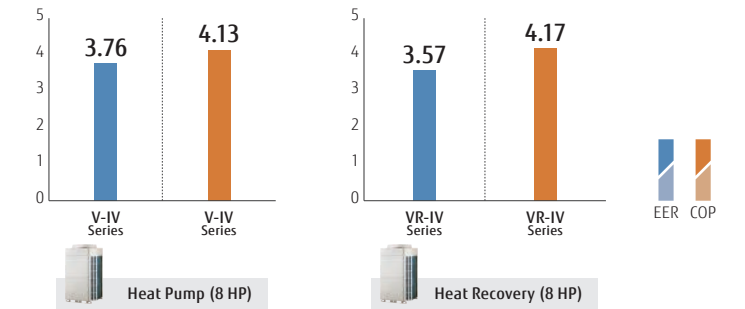

* These specifications are determined by ducted combination.



ALL DC High-efficiency design with top-class SEER/SCOP

All the VRF Series, including the J-IVL Series, have DC technology to achieve high-efficiency operation. This enhances the durability and reliability of the VRF Series.



 1 DC fan motor	 3 DC inverter control
 2 Large heat exchanger	 4 Subcooling heat exchanger



 1 3-phase DC fan motor	 3 Sine-wave DC inverter control
 2 Large heat exchanger	 4 Subcooling heat exchanger

Efficient control of operation

Setting temperature range limitation

Sets the minimum and maximum limits on room temperature to establish an optimum balance between energy-saving performance and a comfortable environment.

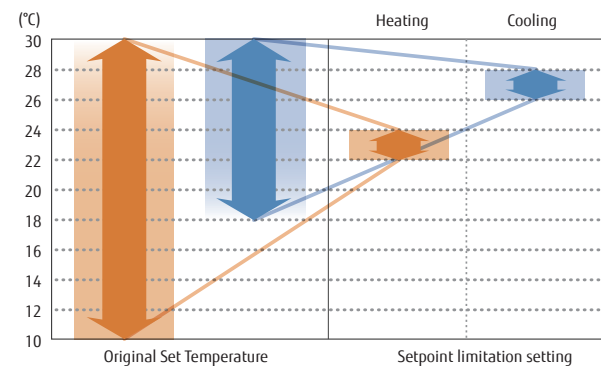

Auto-off timer

The wired remote controller is equipped with an auto-off timer function that automatically stops operation after a fixed period of time has elapsed from the start of operation to avoid wasting energy. The function also allows you to set the interval for stopping operations.

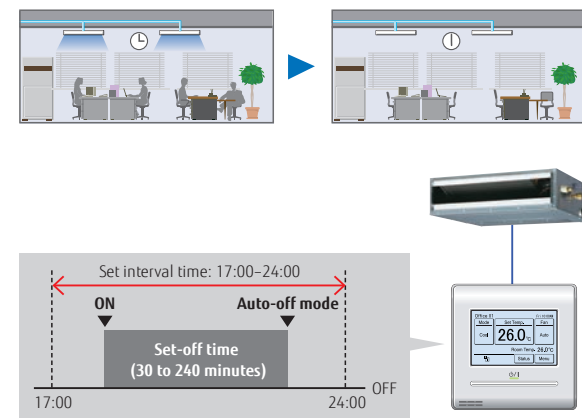

Energy-saving management

A variety of energy-saving operations can be set and managed depending on the season, climate, and time period. Excellent energy-saving operation using the system controller.

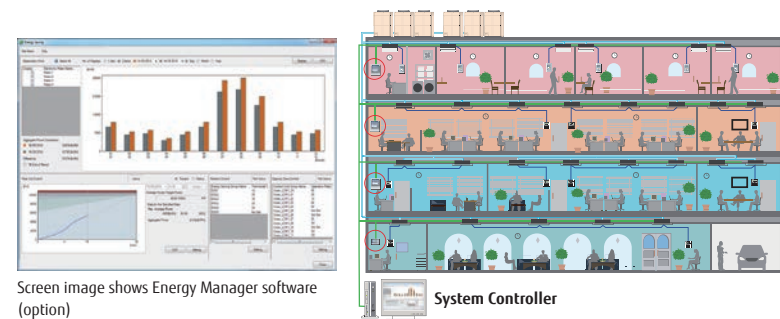

Capacity-saving mode

Operation capacity can be reduced in 5 steps from the rated capacity. This mode cuts down on peak power consumption and eases the maximum load on the unit.

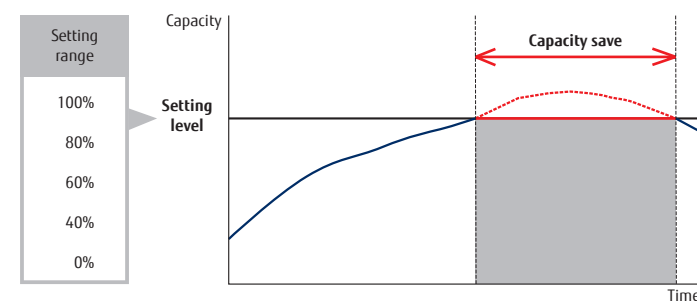

Intelligent refrigerant control

Fujitsu General is proposing outdoor units equipped with refrigerant control function. The refrigerant control operates with subtle control corresponding to the heat load of the room and offers a more comfortable environment. The refrigerant control can also provide increased energy savings.

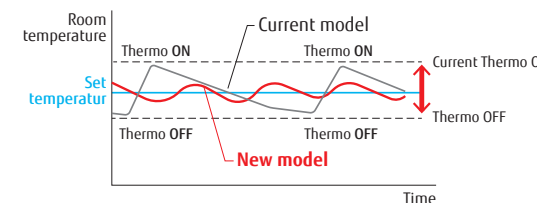

Current refrigerant control

Thermostat-ON/OFF occurs frequently. → Frequent changes in room temperature interfere with comfort. The compressor starts and stops repeatedly, wasting energy.

New refrigerant control

The thermostat is turned on and off less frequently than under current control to maintain the room temperature at the target temperature. Compared to current control, the compressor will run longer, thus saving energy.

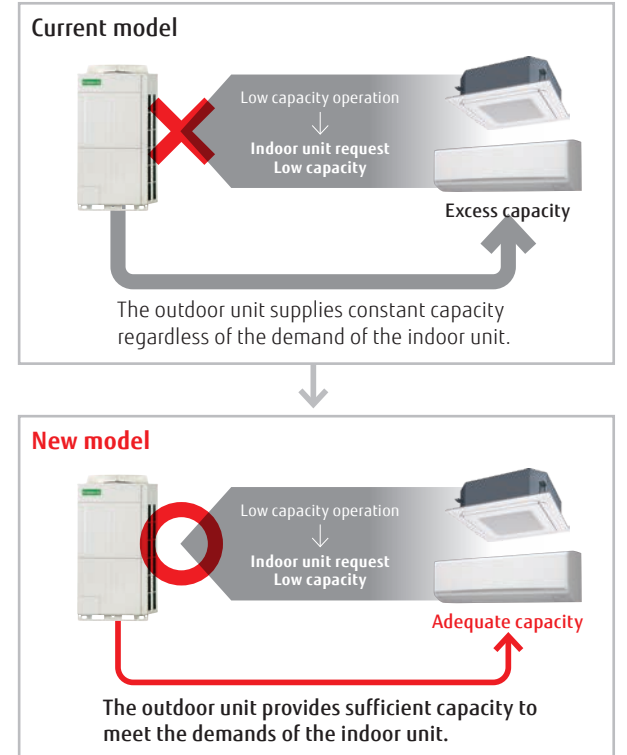

* The improvements due to the control and the actual sine wave vary depending on the combination of the indoor unit and system operating conditions.

More Comfort



Auto changeover

In Auto setting, the air conditioner switches between cooling and heating modes automatically according to the set temperature and the room temperature.

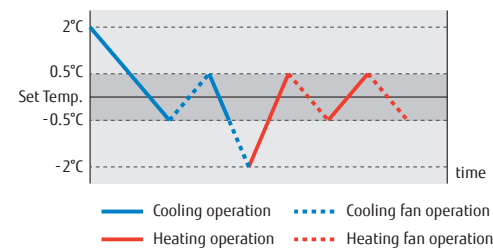

Auto changeover settings enable the indoor unit to easily switch between cooling and heating regardless of the operating mode of other indoor units. These settings can be made using a wired remote controller for a specific indoor unit. Provides a comfortable environment all year round.

Automatic cooling/heating operation for each room is possible

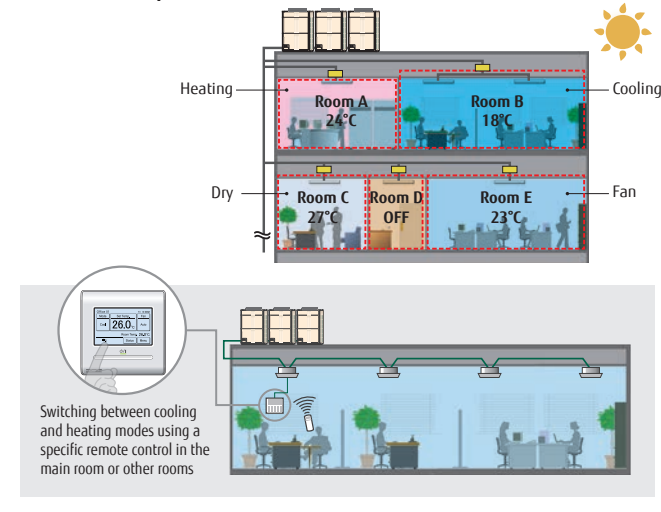

Precise control of refrigerant flow

The combination of DC inverter control and individual control of electronic expansion valves of an indoor unit enables precise and smooth control of the refrigerant flow. This means the room temperature can be set in increments of 0.5°C.

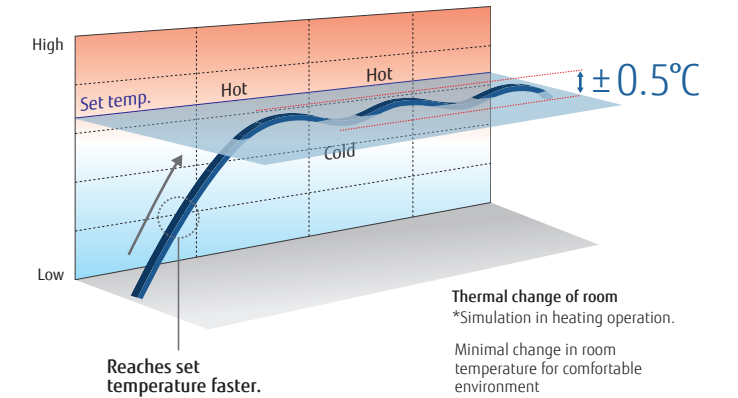

Quiet operation

Quiet operation

Two low noise modes can be switched over automatically between one in which low noise is prioritized over performance, and the other in which performance is prioritized over low noise, depending on the room temperature and outdoor temperature. This feature can be controlled by external input from the outdoor unit or a system controller.

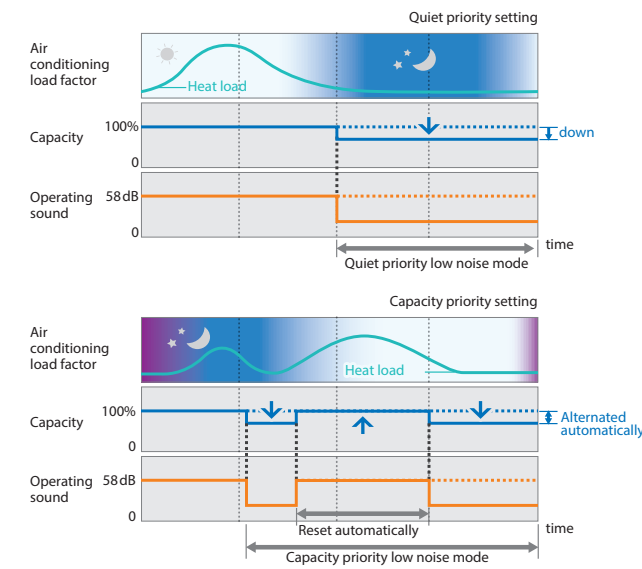

Non-stop oil recovery operation

A comfortable room condition is maintained during oil recovery mode because the product continues to operate without stopping the cooling or heating operation.

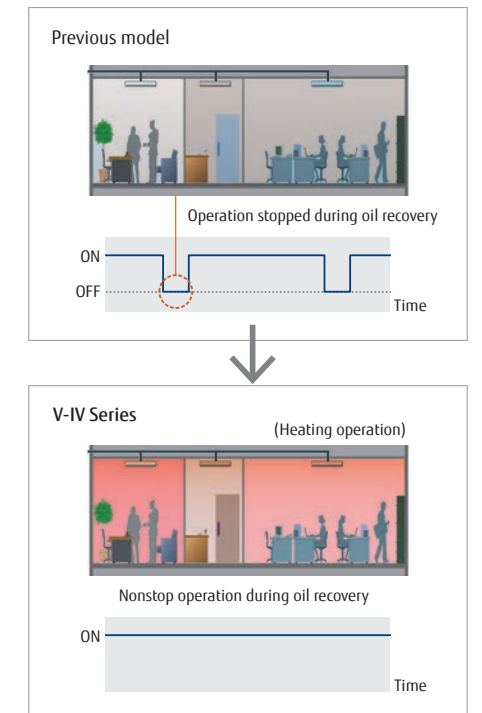

Low noise design

Small-capacity indoor units meet a variety of applications. Super low noise operations offer greater audibility comfort. In particular, the low static pressure duct (04 model) has a noise level of only 20 dB(A) during quiet mode.



Small-capacity indoor unit

High Reliability

Outdoor unit rotation

The compressor starting order is rotated to equalize the cumulative running time of each unit.

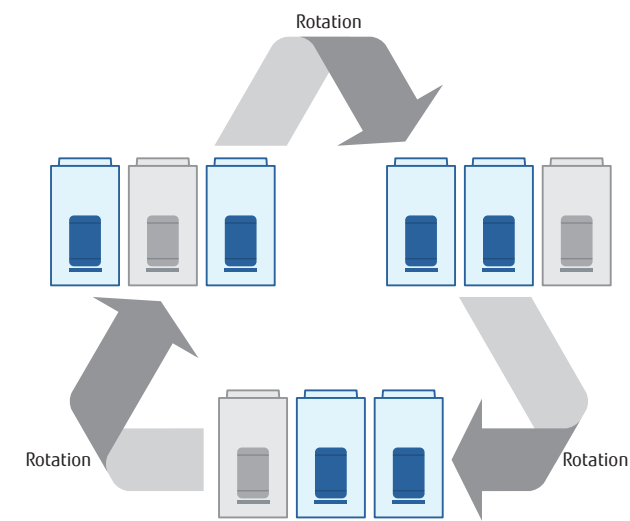

The start and stop timings are alternated among connected compressors.

Backup operation

If one compressor fails, the other compressors will initiate backup operation*.

Note: Backup operation may not be possible depending on the cause of failure.

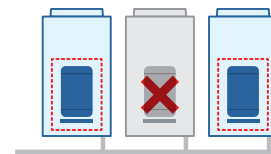

Advanced refrigerant control

Compressor control logic controls the inverter speed to balance the mass airflow rate of refrigerant in each outdoor unit.

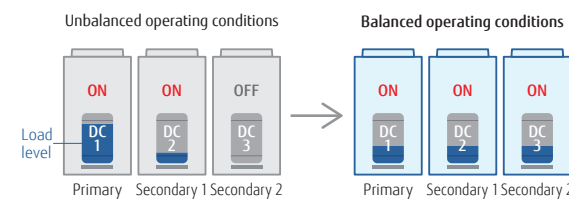

Protection against liquid flowback

The use of a large accumulator means that refrigerant that has not been completely vaporized stays inside the accumulator to ensure no liquid refrigerant is fed into the compressor.

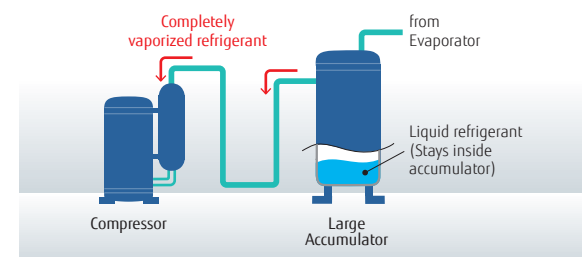

Blue fin heat exchanger

The anti-corrosion blue fin treatment is applied to the heat exchanger of the outdoor unit.

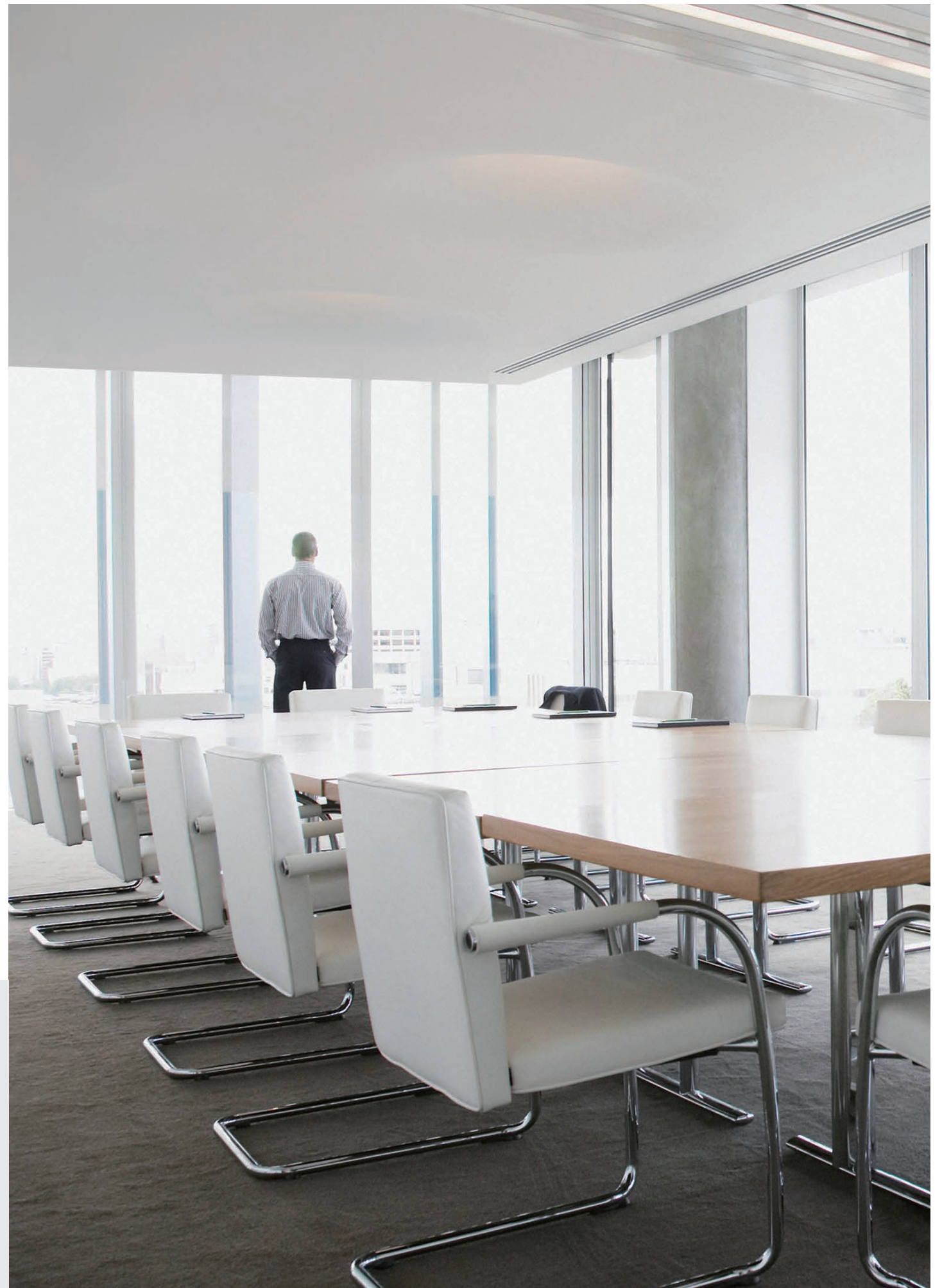
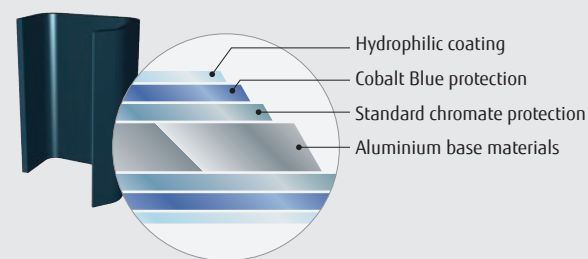

Design flexibility

Class-leading compact design

An industry-leading compact outdoor unit with optimal airflow pattern design. (Up to 18 HP)

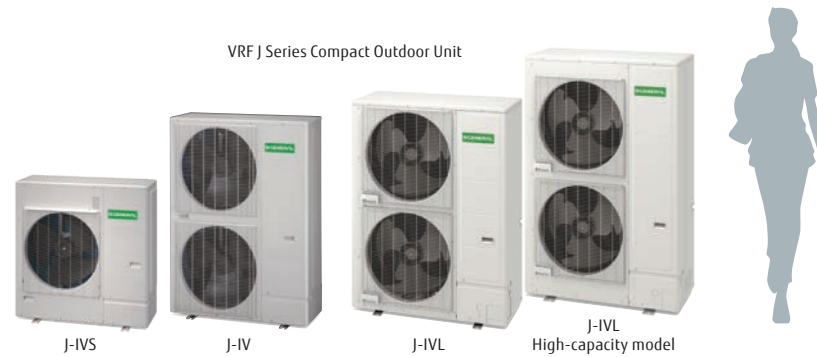

Long pipe design

Pipe design suitable for long and narrow office buildings with elevation differences and low-rise stores with long distances (VRF J-IVL Series)

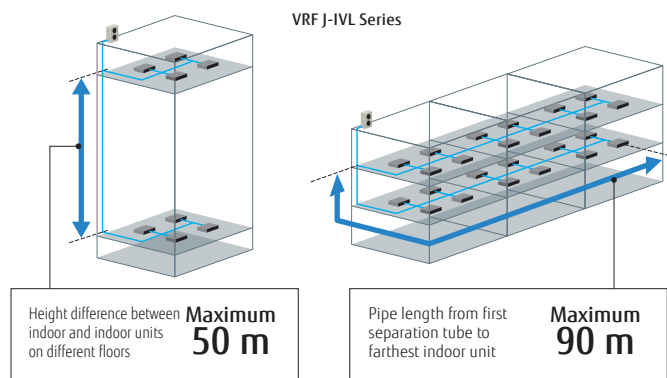

Max. allowable overall pipe length: 1,000 m

The class-leading pipe length of 1,000 m increases flexibility of installation in a wide variety of buildings.

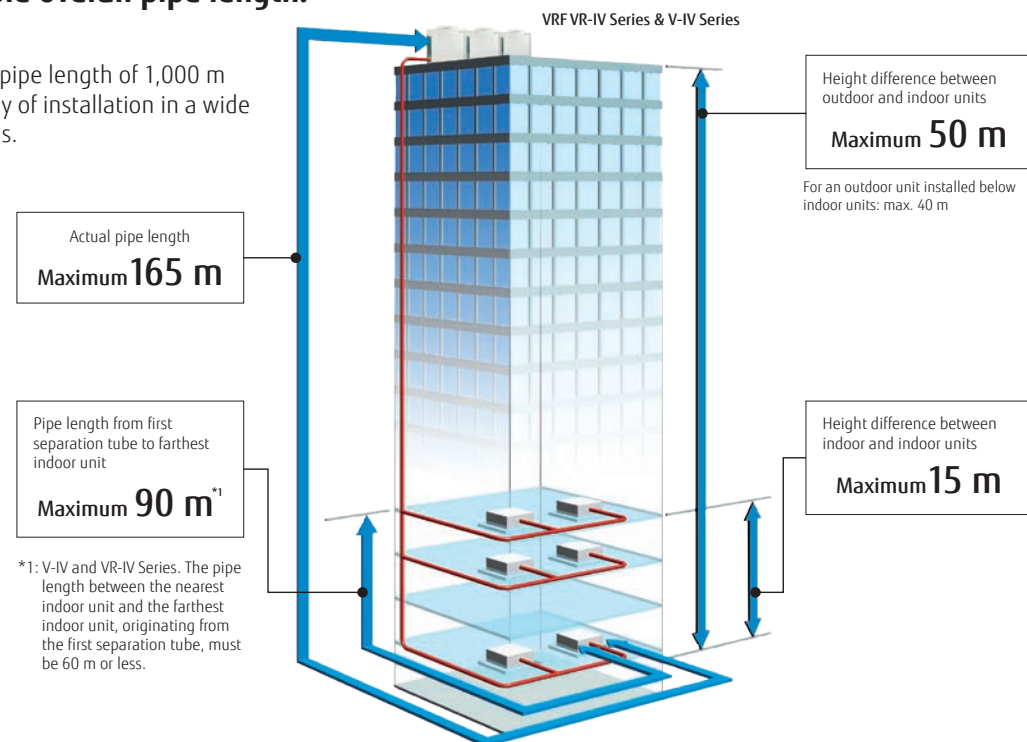

High-capacity connection

Series	Connectable indoor unit capacity range	Connectable indoor units
VRF J-IVL Series 14/16/18 HP Heat pump type	50% to 150% ^{*2}	up to 42 ^{*4}
VRF J-IVL Series 8/10/12 HP Heat pump type	50% to 150% ^{*2}	up to 30 ^{*5}
VRF J-IV Series Heat pump type	50% to 150% ^{*2}	up to 14 ^{*6}
VRF J-IVS Series Heat pump type	50% to 130% ^{*2}	up to 13 ^{*7}
VRF VR-IV Series Heat Recovery Modular type	25% ^{*7} to 150% ^{*2}	up to 64
VRF V-IV Series Heat Pump Modular type	50% to 150% ^{*3}	up to 64

^{*2}: Conditions for the maximum capacity ratio of connectable indoor units are shown in the chart above.
^{*3}: The maximum capacity of the combination that includes the 18-HP outdoor unit is below 150%.
^{*4}: J-IVL Series 18-HP model only.
^{*5}: J-IVL Series 12-HP model only.
^{*6}: J-IV Series 6-HP model only.
^{*7}: J-IVS Series 6-HP model only.

Designed for low refrigerant charge

The optimal design of the indoor and outdoor units reduces the amount of refrigerant required and can be easily installed in a room as small as 15 m².



Various optional parts

- Fresh air intake kit to bring in fresh air
- Comfortable temperature control with a remote sensor
- DX kit links ventilation equipment and air handling units.

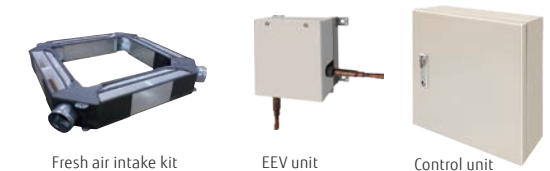

Low ambient operation

Our refrigeration cycle technology enables cooling operation even at -15°C.



Wide operating temperature range

All outdoor units have a wide operating temperature range and can operate in extreme temperature conditions.

^{*8}: When multiple outdoor units are connected, their operating temperature range is from -5°C to 46°C in cooling.
^{*9}: The operating range is -15°C to 46°C only for systems with all indoor units rated at 5.6 kW or more.

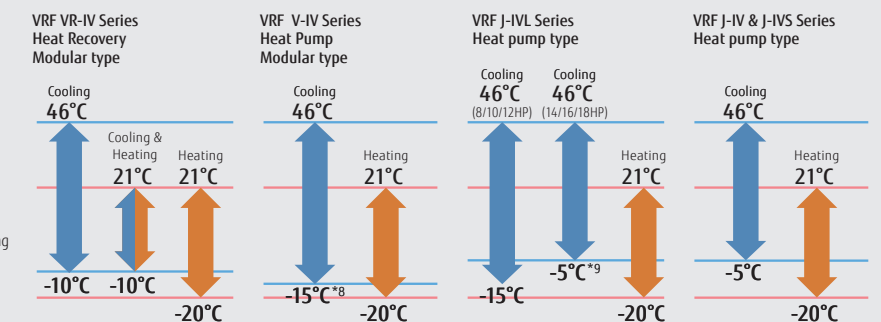

Easy Installation



Easily transported

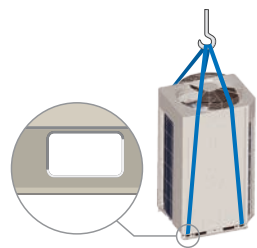

A lifting strap can be hooked onto an outdoor unit
Design of outdoor unit allows for lifting straps to be used

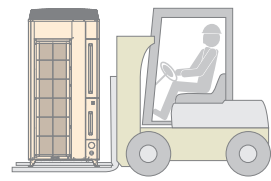

Transportable by forklift
The outdoor unit can be lifted and transported by forklift.

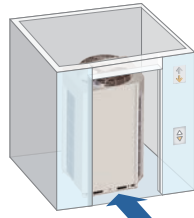

Fits into a small elevator.

Easy access

The removable L-shaped front panel provides more room for installation and service work. Multiple installations can be performed easily and efficiently even in tight spaces.

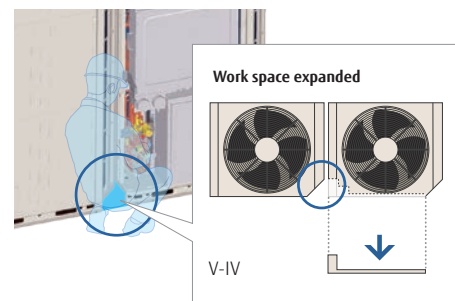

Front access reduces installation intervals

Flexible pipe connection

Piping and wiring can be accessed from the front, left, right, and bottom.

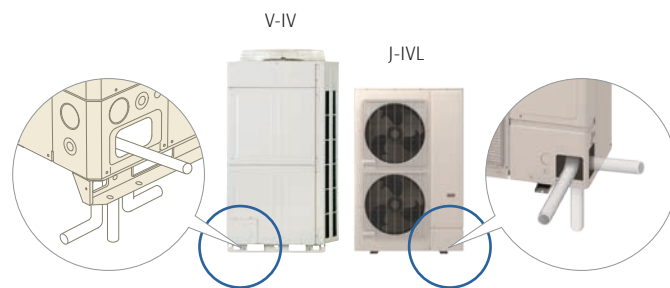

Simplified wiring work

The communication wiring can be installed seamlessly among indoor, outdoor, and RB units, which makes the installation of the wiring system easier.

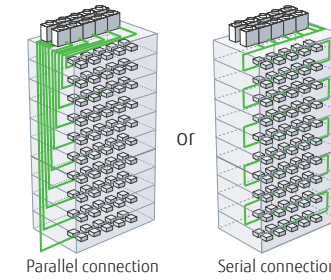

Maximum wiring length:
3,600 m

Note: The automatic address setting is not available on a serially connected multiple refrigerant system.

Vacuum mode function for easy evacuation

The vacuum mode function enables all expansion valves of an indoor unit to be opened fully, allowing for easier evacuation of air inside pipe lines and indoor units.

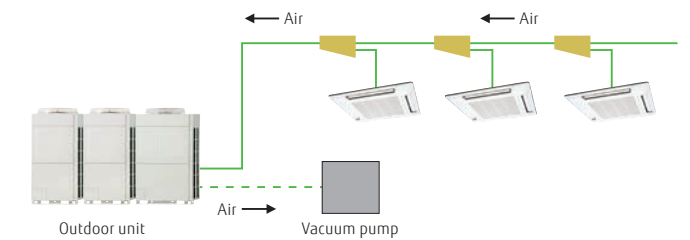

Automatic address setting

Addresses of connected indoor units, RB units, and Signal amplifier can all be set automatically from the PCB in the outdoor unit.

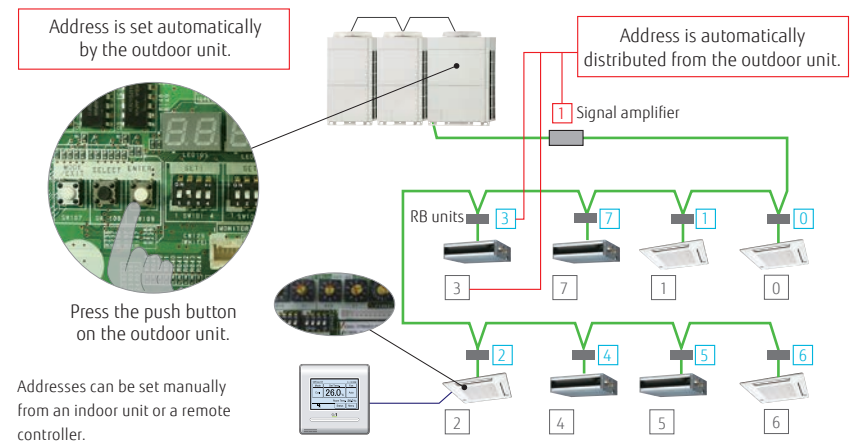

Easy commissioning with Service Tool

The Service Tool checks the refrigerant temperature and pressure, and the operating status of the electronic expansion valves, making it easy to determine if the units are connected properly.



Easy service and maintenance

Designed for easy maintenance

A 7-segment indicator lamp panel provides detailed information on the function setting status, refrigerant temperature and pressure, compressor operation time, and other factors, facilitating self-diagnosis for each unit.

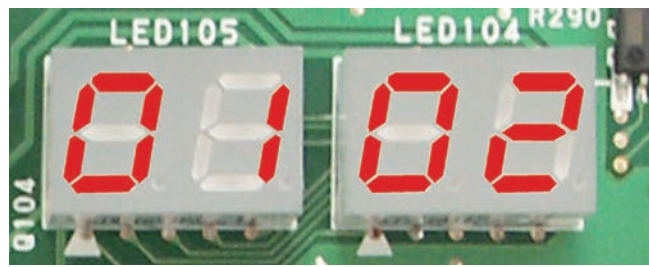

Easy-to-read 7-segment indicator lamp

Shows the following detailed operation and error status without need of any special tools.

Error status can be checked on an outdoor unit's display

- System operation mode
- Discharge temperature and pressure
- Compressor operation status
- Address, type, and number of outdoor unit

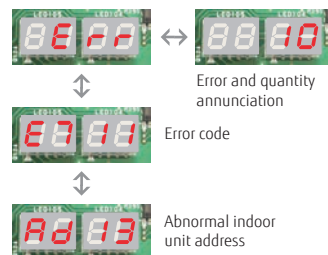

- Error status can easily be checked on an outdoor unit's display.

Movable PCB panel

Enables easier access behind the PCB for maintenance work.

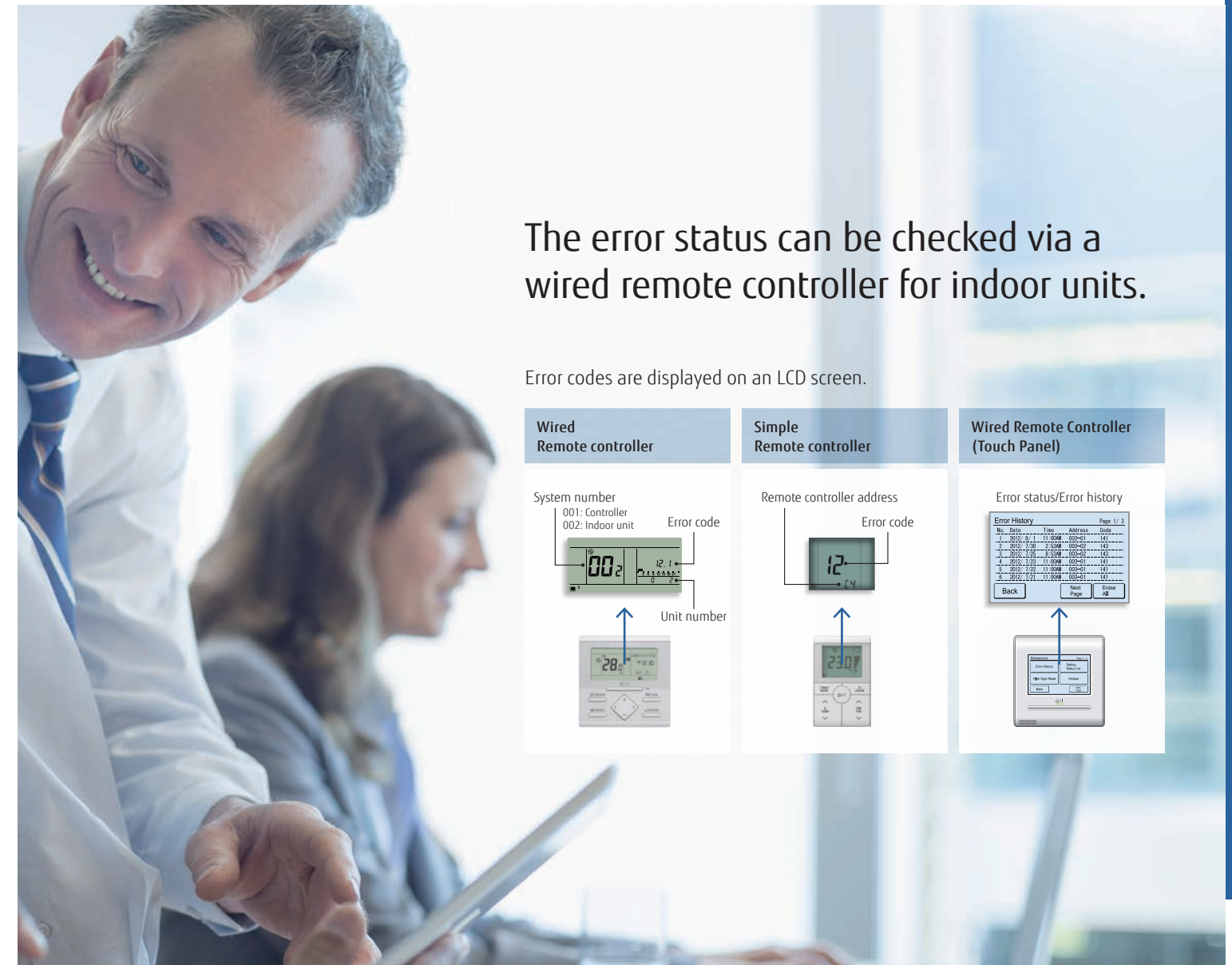
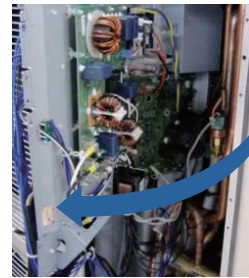

The error status can be checked via a wired remote controller for indoor units.

Error codes are displayed on an LCD screen.

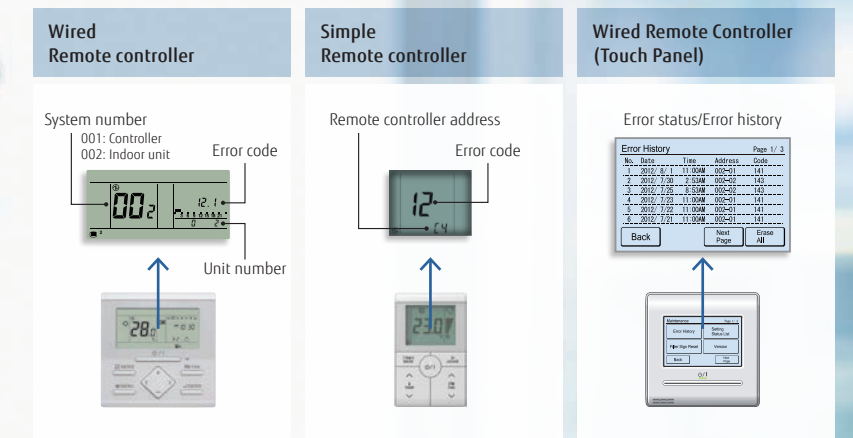

Error diagnosis by Service tool

Connection to Service tool

- A detailed operation status and recent error history can be checked and analyzed using Service tool.
- The last 5 minutes of operation status can be recorded continuously.

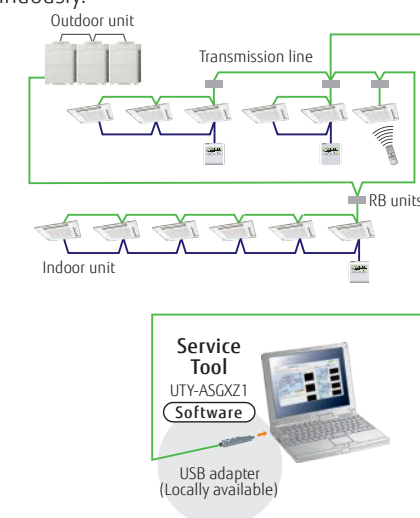

Remote monitoring

The Web Monitoring system enables the monitoring of the system's operation status at any time via the internet to ensure trouble-free operation. The operating VRF network system in the building can be monitored real time over the internet.

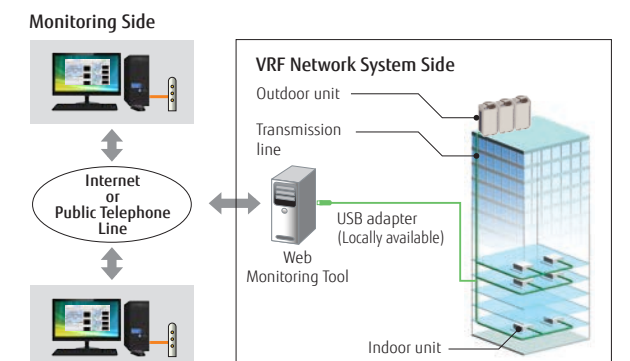

Heat Pump

for Small-capacity type

VRF J-IVL

System configuration example

- Suitable for air conditioning small and medium-size buildings. One refrigerant system is used for each outdoor unit.
- Multiple indoor units are connected with separation tubes and headers.

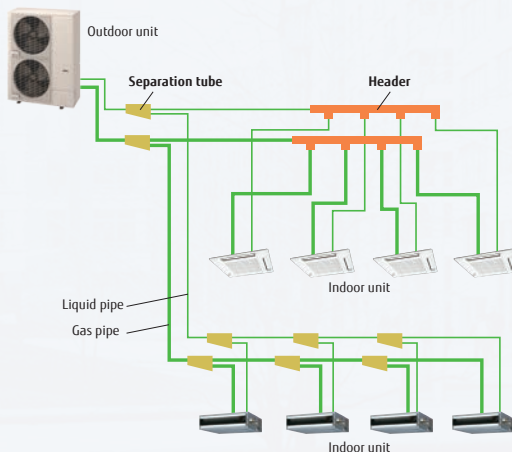

New intelligent refrigerant control

Fujitsu General is proposing outdoor units equipped with refrigerant control function. The refrigerant control operates with suitable control corresponding to the heat load of the room and offers a more comfortable environment. The refrigerant control can also provide increased energy savings.

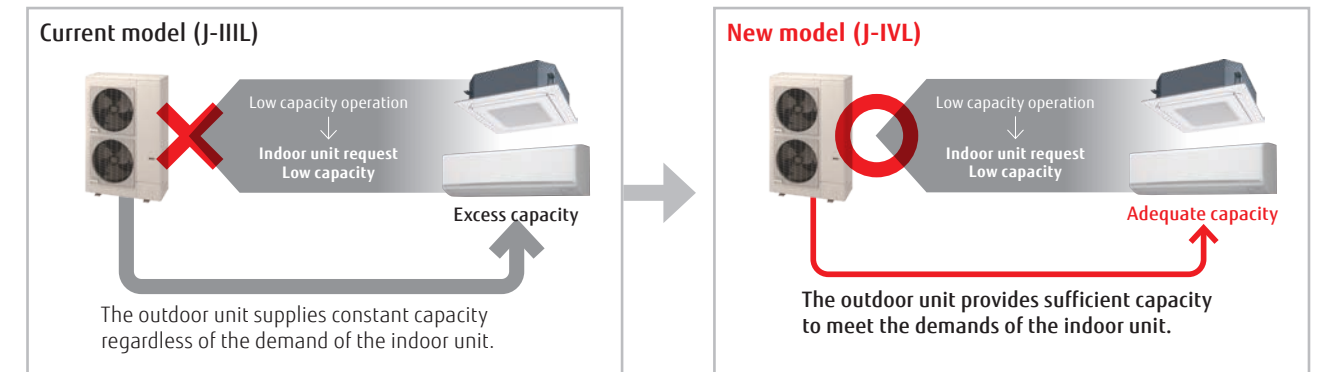

* The improvements due to the control and the actual sine wave vary depending on the combination of the indoor unit and system operating conditions.

External static pressure

External static pressure is available up to 60 Pa for 14/16/18 HP. (30 Pa for 8/10 HP, 40 Pa for 12 HP)

Capacities are slightly decreased relative to the rated values during high static pressure operations.



Advanced high-efficiency technology

Ø570 mm Large propeller fan
A large-diameter propeller fan with our proprietary blade design reduces draft loss, which results in high-efficiency and low noise operation.

DC fan motor
A small, multi-stage DC fan motor provides high-efficiency and low noise operation.

Large heat exchanger
The large 2.6-row heat exchanger substantially improves heat-exchanging performance.

DC inverter control
The active filter module improves efficiency.

Subcooling heat exchanger
The dual-tube heat exchanger improves cooling performance.

Scroll compressor
The combination of a scroll compressor with a wide rotational frequency range from 15 to 130 rps and our proprietary sensorless sine-wave control that smoothly controls the input power into the motor achieves more energy-efficient and quieter operation.

15 to 130 rps



Fujitsu General offers a perfect total air conditioning system for small office buildings with multiple small rooms, taking into consideration energy savings, low noise, comfortable air volume, usage and purpose, and centralized control.

VRF J-IVL

Image: 8/10/12 HP models

Slim & Compact design



Various installation methods

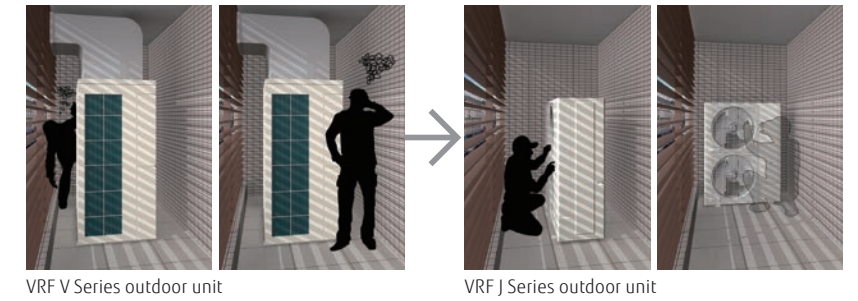

Installation Low noise level in consideration of nearby residents

Front air discharge type with a width of about 1,000 mm, allowing for flexible installation even in narrow spaces.



Narrow space behind building Space saving

Small and thin, allowing for direct ground or wall mounting installations even in narrow alleys.



Installation on the back street of a building Flexible installation

Slim, low-body front air discharge meets the requirements for installation even in tight spaces. Installation flexibility without blocking the windows of buildings contributes to substantial space savings, even when multiple units are installed.

Efficiency in actual operating conditions

The use of a large heat exchanger and a high-efficiency Scroll compressor achieves class-leading EER/COP (Max. Heating) in all models.

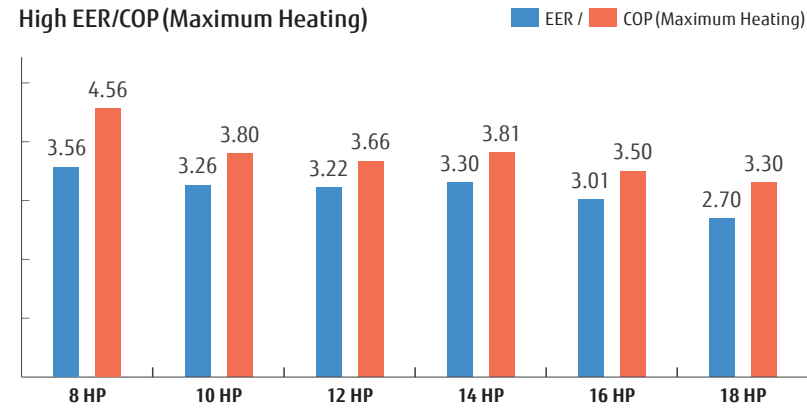

* These specifications are determined by cassette combination.

Long pipe length

Our advanced refrigerant control technology extends the maximum allowable length of refrigerant piping to 400 m. This provides high flexibility in system design.

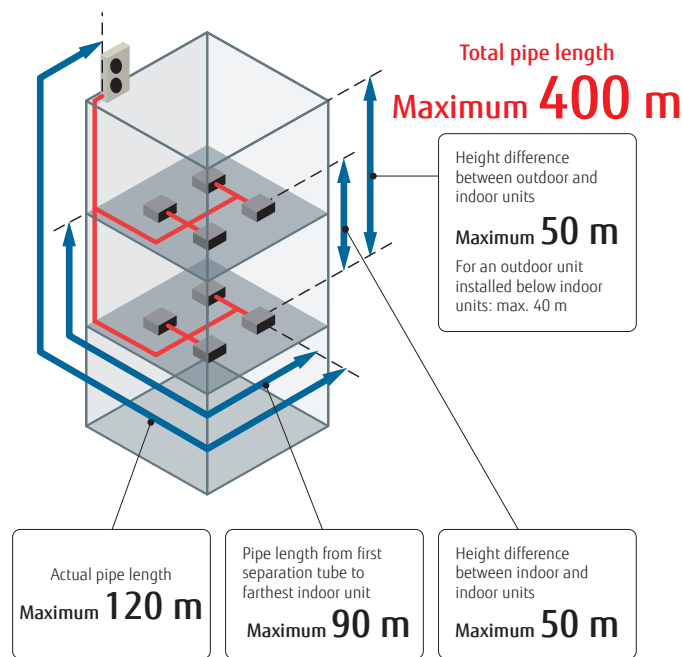

Up to 42 indoor units* can be connected.

The combination of smaller but sufficiently powerful indoor units and a new outdoor unit with an optimized heat exchanging structure makes it possible to connect up to 42 indoor units, which is the best in its class. *: 18 HP model

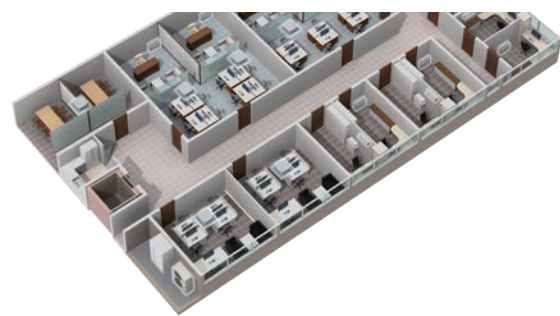

Class-leading low operating sound

The top-class low operating noise makes it ideal for use in densely populated areas. These low operating sound models are ideal for installation in densely populated areas.

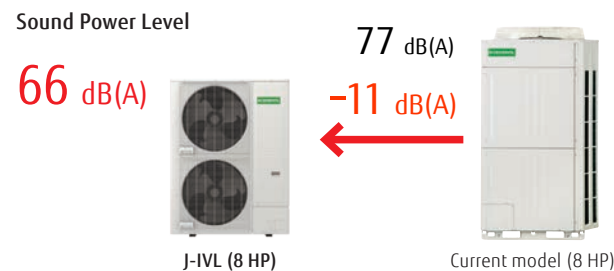

8,10,12 HP: AJH072LELDH / AJH090LELDH / AJH108LELDH
14,16,18 HP: AJH126LELDH / AJH144LELDH / AJH162LELDH



Specifications

Rated capacity range		HP	8	10	12	14	16	18
Model name			AJH072LELDH	AJH090LELDH	AJH108LELDH	AJH126LELDH	AJH144LELDH	AJH162LELDH
Maximum connectable indoor units			1-20	1-25	1-30	1-36	1-40	1-42
Power source			3-phase, ~400V, 50Hz					
Capacity	Cooling	kW	22.4	28.0	33.5	40.0	45.0	50.0
	Nominal Heating	kW	22.4	28.0	33.5	40.0	45.0	50.0
	Max. Heating	kW	25.0	31.5	37.5	45.0	50.0	55.0
Input power	Cooling	kW	6.30	8.59	10.42	12.12	14.96	18.52
	Nominal Heating	kW	4.65	6.61	8.18	9.71	11.81	13.66
	Max. Heating	kW	5.45	8.29	10.25	11.81	14.29	16.66
EER	Cooling		3.56	3.26	3.22	3.30	3.01	2.70
	Nominal Heating	W/W	4.82	4.24	4.10	4.12	3.81	3.66
	Max. Heating	W/W	4.56	3.80	3.66	3.81	3.50	3.30
SEER	Cooling		7.62	7.50	7.27	7.27	7.00	6.29
	Heating		3.89	3.61	3.63	3.53	3.51	3.54
SCOP	Cooling	%	301.8	297.0	287.8	287.8	277.0	248.6
	Heating	%	152.6	141.4	142.2	138.2	137.4	138.6
Airflow rate		m ³ /h	8,400	9,000	11,000/12,100	13,000	14,000	14,800/15,300
Sound pressure level/ Power level	Cooling	dB(A)	52/66	54/69	59/73	62/75	64/77	65/79
	Heating	dB(A)	54/66	57/70	62/75	63/76	65/78	68/82
Net Dimensions	Height	mm	1,428	1,428	1,428	1,638	1,638	1,638
	Width	mm	1,080	1,080	1,080	1,080	1,080	1,080
	Depth	mm	480	480	480	480	480	480
Weight		kg	170	177	178	213	213	217
	Type (Global Warming Potential)		R410A (2,088)	R410A (2,088)	R410A (2,088)	R410A (2,088)	R410A (2,088)	R410A (2,088)
Refrigerant	Charge	kg (CO2eq-T)	7.0 (14.6)	7.5 (15.7)	7.5 (15.7)	11.0 (23.0)	11.0 (23.0)	11.8 (24.6)
	Liquid	mm	9.52	9.52	12.70	12.70	12.70	12.70
Connection pipe diameter	Gas	mm	19.05	22.20	28.58	28.58	28.58	28.58
	Total pipe length	m	400	400	400	400	400	400
Max. height difference			50/40 (Outdoor unit: Upper/Lower)					
	Cooling	°C	-15 to 46	-15 to 46	-15 to 46	-5 to 46*	-5 to 46*	-5 to 46*
Operating Range	Heating	°C	-20 to 21	-20 to 21	-20 to 21	-20 to 21	-20 to 21	-20 to 21

Note: Specifications are based on the following conditions.

Cooling: Indoor temperature of 27°CDB / 19°CWB, and outdoor temperature of 35°CDB / 24°CWB.

Heating: Indoor temperature of 20°CDB / 15°CWB, and outdoor temperature of 7°CDB / 6°CWB.

Pipe length: 7.5 m; Height difference between outdoor unit and indoor unit: 0 m.

* The cooling operation range of -15 to 46°C is allowed only when all of the indoor units connected to the system are higher than capacity of 5.6kW.

Dimensions

(Unit: mm)

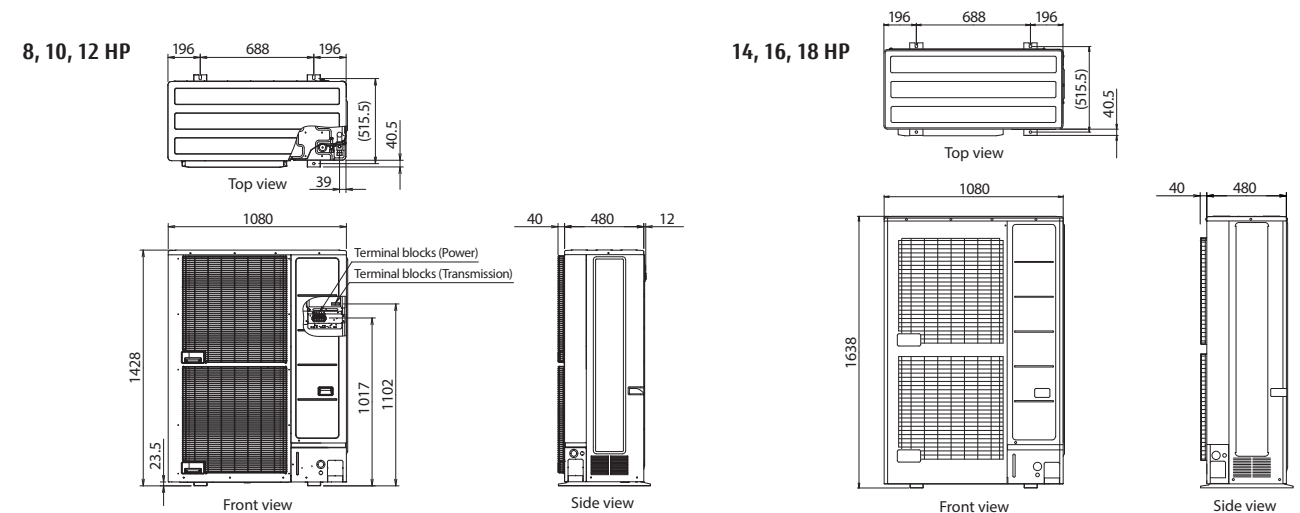

Heat Pump

for Small-capacity type

VRF J-IV

System configuration example

- Suitable for air conditioning small and medium-size buildings. One refrigerant system is used for each outdoor unit.
- Multiple indoor units are connected with separation tubes and headers.

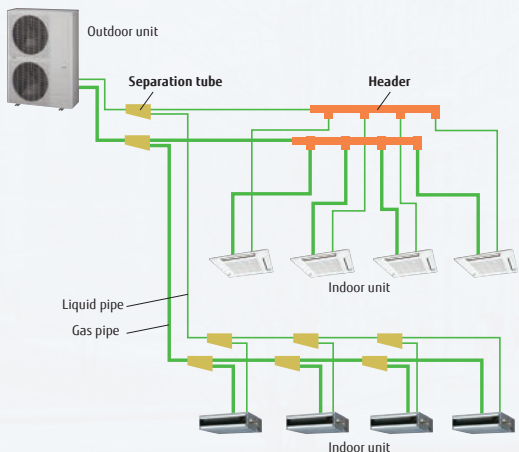

New intelligent refrigerant control

Fujitsu General is proposing outdoor units equipped with refrigerant control function. The refrigerant control operates with suitable control corresponding to the heat load of the room and offers a more comfortable environment. The refrigerant control can also provide increased energy savings.

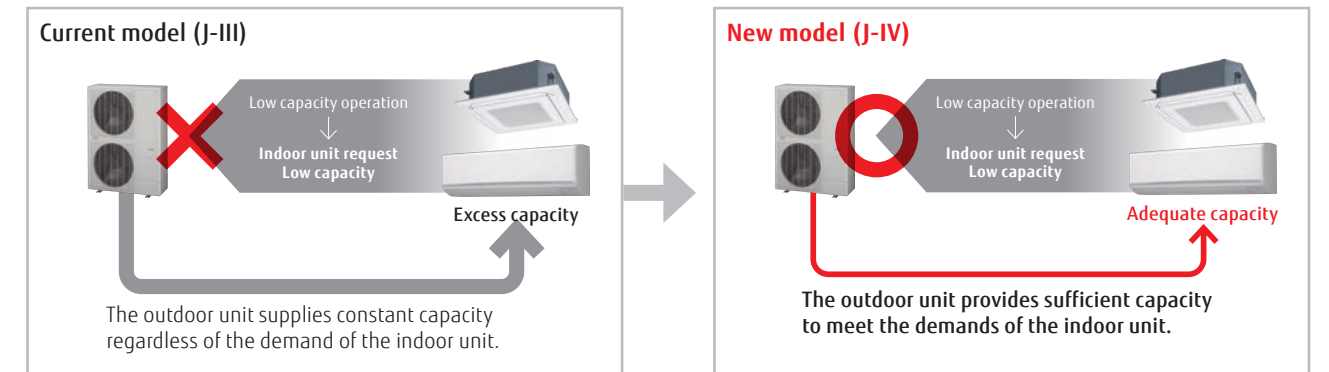

* The improvements due to the control and the actual sine wave vary depending on the combination of the indoor unit and system operating conditions.

External static pressure

External static pressure measures up to 30 Pa for 4/5/6 HP.



Advanced high-efficiency technology

Large propeller fan
A large propeller fan with an optimized blade angle achieves both high performance and low noise operation.

DC fan motor
A small, multi-stage DC fan motor contributes to high-efficiency and low noise operation.

Large heat exchanger
The large 3-row heat exchanger substantially improves heat-exchanging performance.

DC twin-rotary compressor
High-efficiency is achieved across compressor loads. Especially good performance is achieved in the low- to medium-load range.

Subcooling heat exchanger
The dual-tube heat exchanger improves cooling performance.

DC inverter control
The active filter module improves efficiency.

High-efficiency compressor motor
Optimized refrigerant flow design
Highly accurate parts

Pressure
Enthalpy
effect
Cooling performance improved

High
Compressor efficiency
DC Twin-Rotary Compressor
Compressor capacity High

Efficiency in actual operating conditions

The use of a large heat exchanger and a high-efficiency Scroll compressor achieves class-leading EER/COP (Max. Heating) in all models.

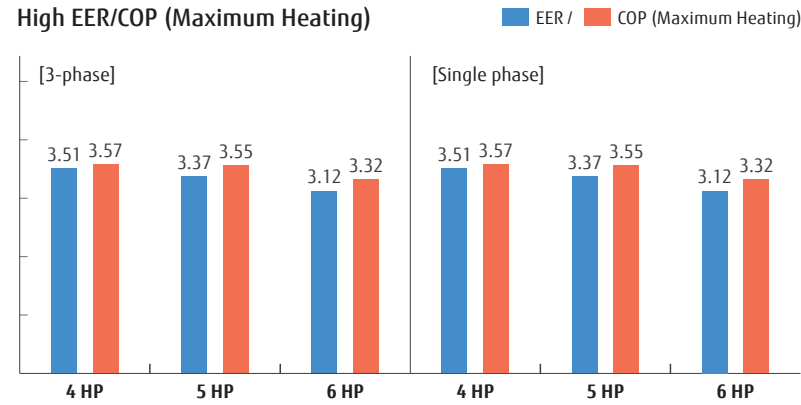

* These specifications are determined by cassette combination.



Long pipe length

Our advanced refrigerant control technology allows us to achieve a total refrigerant pipe length of 180 m. This provides high flexibility in system design.

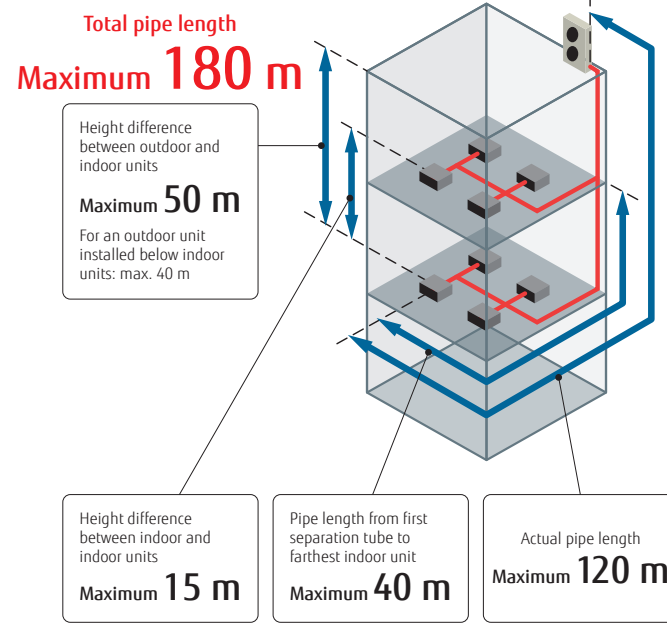

Up to 14 indoor units* can be connected

The combination of smaller but sufficiently powerful indoor units and outdoor units with an optimized heat exchanging structure makes it possible to connect up to 14 indoor units, which is the best in its class.

*: 6 HP model

Model	Current model (J-III)			New model (J-IV)		
	4	5	6	4	5	6
Rating Capacity range (HP)	4	5	6	4	5	6
Max. Connectable indoor unit	1-9	1-10	1-13	1-11	1-12	1-14

4,5,6HP: AJH040LBDH / AJH045LBDH / AJH054LBDH AJH040LELDH [3-phase] / AJH045LELDH [3-phase] / AJH054LELDH [3-phase]

Specifications

Rated capacity range		HP	4	5	6	4	5	6
Model name			AJH040LBDH	AJH045LBDH	AJH054LBDH	AJH040LELDH	AJH045LELDH	AJH054LELDH
Maximum connectable indoor units			1-11	1-12	1-14	1-11	1-12	1-14
Power source			Single phase, ~230 V, 50 Hz			3-phase, ~400 V, 50 Hz		
Capacity	Cooling	kW	12.1	14.0	15.5	12.1	14.0	15.5
	Nominal Heating		12.1	14.0	15.5	12.1	14.0	15.5
	Max. Heating		13.6	16.0	18.0	13.6	16.0	18.0
Input power	Cooling	kW	3.44	4.15	4.96	3.44	4.15	4.96
	Nominal Heating		3.14	3.60	4.17	3.14	3.60	4.17
	Max. Heating		3.80	4.50	5.41	3.80	4.50	5.41
EER	Cooling		3.51	3.37	3.12	3.51	3.37	3.12
COP	Nominal Heating	W/W	3.85	3.88	3.71	3.85	3.88	3.71
	Max. Heating		3.57	3.55	3.32	3.57	3.55	3.32
	SEER	Cooling	6.50	6.30	6.08	6.50	6.30	6.08
SCOP	Heating		3.83	3.93	3.94	3.83	3.93	3.94
ηc	Cooling	%	257.0	249.0	240.0	257.0	249.0	240.0
ηh	Heating		150.0	154.0	155.0	150.0	154.0	155.0
Airflow rate		m³/h	6,200	6,600	7,000	6,200	6,600	7,000
Sound pressure level/ Power level	Cooling	dB(A)	50 / 65	52 / 66	53 / 67	50 / 65	52 / 66	53 / 67
	Heating		52 / 67	55 / 69	56 / 69	52 / 67	55 / 69	56 / 69
Heat exchanger fin			Blue fin	Blue fin	Blue fin	Blue fin	Blue fin	Blue fin
	Height	mm	1,334	1,334	1,334	1,334	1,334	1,334
	Width		970	970	970	970	970	970
Net Dimensions	Depth	mm	370	370	370	370	370	370
	Weight	kg	117	117	119	118	119	119
Refrigerant	Type (Global Warming Potential)		R410A (2,088)	R410A (2,088)	R410A (2,088)	R410A (2,088)	R410A (2,088)	R410A (2,088)
	Charge	kg (CO2eq-T)	4.8 (10.0)	5.3 (11.1)	5.3 (11.1)	4.8 (10.0)	5.3 (11.1)	5.3 (11.1)
Connection pipe diameter	Liquid	mm	9.52	9.52	9.52	9.52	9.52	9.52
	Gas		15.88	15.88	19.05	15.88	15.88	19.05
Total pipe length		m	180	180	180	180	180	180
Max. height difference			50/40 (Outdoor unit: Upper/Lower)			50/40 (Outdoor unit: Upper/Lower)		
Operating Range	Cooling	°C	-5 to 46	-5 to 46	-5 to 46	-5 to 46	-5 to 46	-5 to 46
	Heating		-20 to 21	-20 to 21	-20 to 21	-20 to 21	-20 to 21	-20 to 21

Note: Specifications are based on the following conditions.
Cooling: Indoor temperature of 27°CDB/19°CWB, and outdoor temperature of 35°CDB/24°CWB.
Heating: Indoor temperature of 20°CDB/15°CWB, and outdoor temperature of 7°CDB/6°CWB.
Pipe length: 7.5 m; Height difference between outdoor unit and indoor unit: 0 m.
The protective function may work when using it outside the operation range.

Dimensions

(Unit: mm)

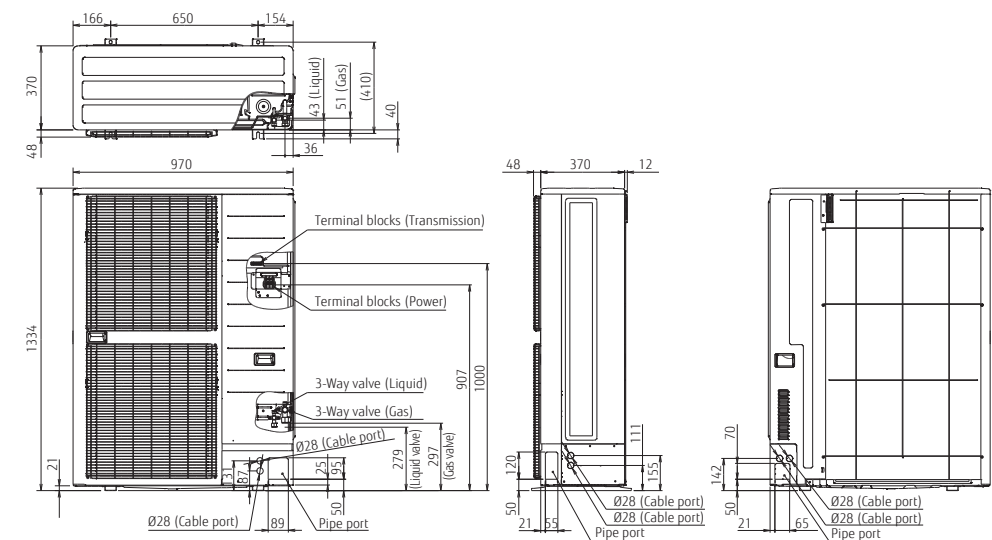

Non-stop oil recovery operation

A comfortable room condition is maintained during oil recovery mode because the product continues to operate without stopping the cooling or heating operation.

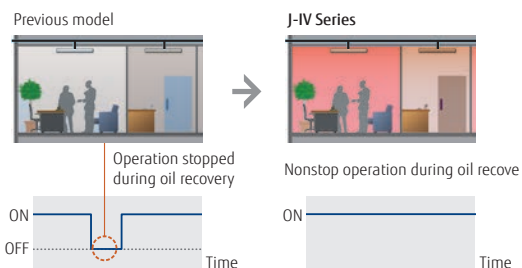

Easier installation

Connection check function: Wiring connections and address settings can be checked thanks to the quick check run function.

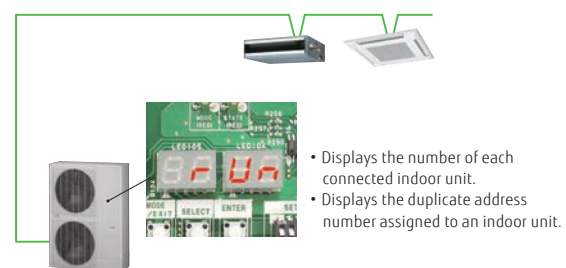

Heat Pump

for Small-capacity type

VRF J-IVS

System configuration example

- Suitable for air conditioning small and medium-size buildings. One refrigerant system is used for each outdoor unit.
- Multiple indoor units are connected with separation tubes and headers.

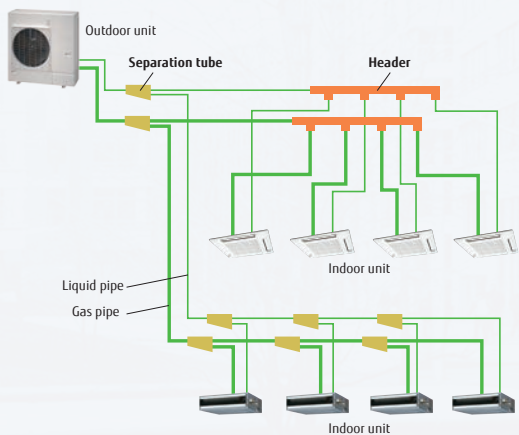

New intelligent refrigerant control

Fujitsu General is proposing outdoor units equipped with refrigerant control function. The refrigerant control operates with suitable control corresponding to the heat load of the room and offers a more comfortable environment. The refrigerant control can also provide increased energy savings.

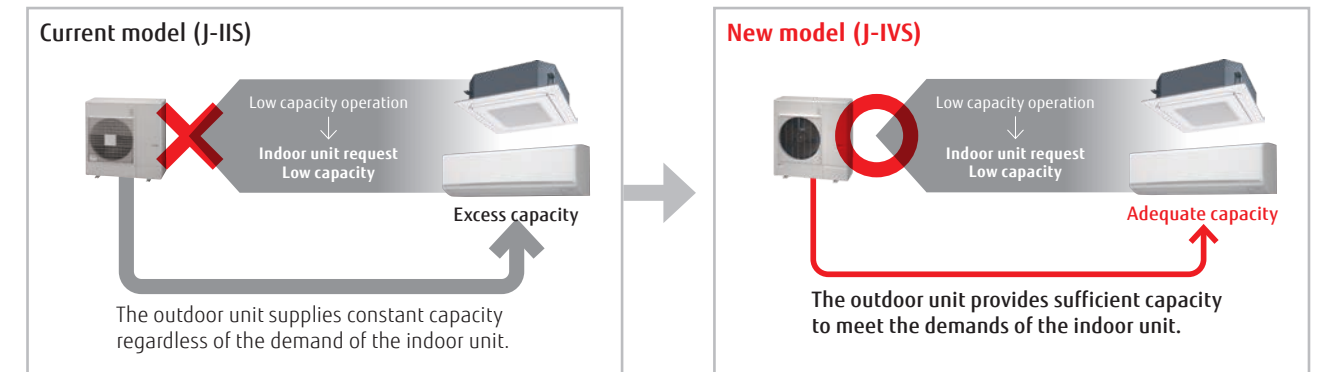

* The improvements due to the control and the actual sine wave vary depending on the combination of the indoor unit and system operating conditions.

External static pressure

External static pressure measures up to 25 Pa for 4/5/6 HP models.



Advanced high-efficiency technology

Large propeller fan
A large propeller fan with an optimized blade angle achieves both high performance and low noise operation.

DC fan motor
A small, multi-stage DC fan motor provides high-efficiency and low noise operation.

DC inverter control
The active filter module improves efficiency.

Compact and high-performance DC twin-rotary compressor
High-efficiency is achieved across compressor loads. Especially good performance is achieved in the low- to medium-load range.

Large heat exchanger
The large 3-row heat exchanger substantially improves heat-exchanging performance.

High heat-transfer copper tube (Improved lead angle)

Easy to carry, easy to install

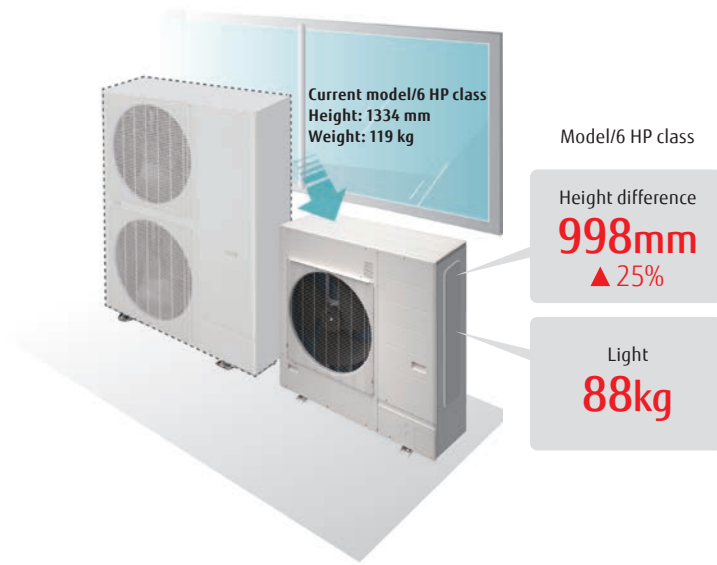

Small, lightweight outdoor unit

The outdoor units in this series are much more compact than conventional outdoor units of comparable capacity. They can be installed on a balcony, fitting below the height of the railing. With a height of less than 1 m, they can be installed in tight spaces such as under windows.

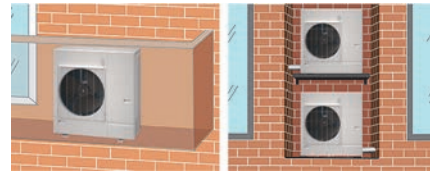

Low noise design

Significantly low noise levels are achieved by the use of a DC twin-rotary compressor, inverter technology, and an advanced airflow pattern design.



Long pipe length

Our advanced refrigerant control technology extends the maximum allowable length of refrigerant piping to 80 m. This provides high flexibility in system design.

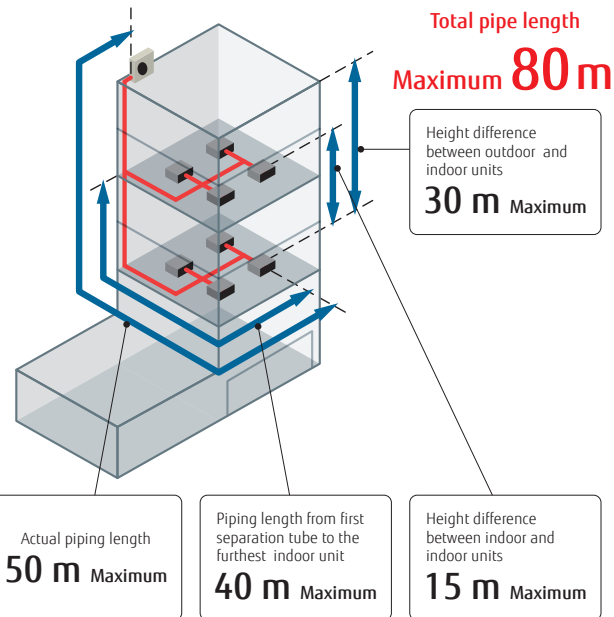

Up to 13 indoor units* can be connected

The combination of smaller but sufficiently powerful indoor units and a new outdoor unit with an optimized heat exchanging structure makes it possible to connect up to 13 indoor units, which is the best in its class.

*: 6 HP model

Model	Current model (J-IVS)			New model (J-IVS)		
	4	5	6	4	5	6
Rating Capacity range (HP)	4	5	6	4	5	6
Max. Connectable indoor unit	1-7	1-8	1-8	1-11	1-12	1-13

Non-stop oil recovery operation

A comfortable room condition is maintained during oil recovery mode because the product continues to operate without stopping the cooling or heating operation.

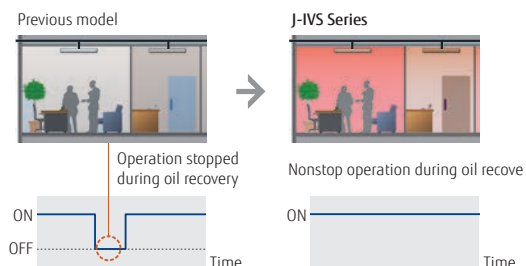

Easier installation

Connection check function: Wiring connections and address settings can be checked thanks to the quick check run function.

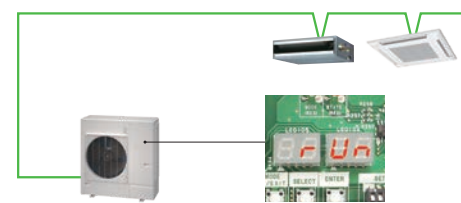

- Displays the number of each connected indoor unit.
- Displays the duplicate address number assigned to an indoor unit.

Specifications

Rated capacity range	HP	4	5	6
Model name		AJH040LCLDH	AJH045LCLDH	AJH054LCLDH
Maximum connectable indoor units		1-11	1-12	1-13
Power source		Single phase, ~230 V, 50 Hz		
Capacity	Cooling	12.1	14.0	15.1
	Nominal Heating	12.1	14.0	15.1
	Max. Heating	13.6	16.0	16.5
Input power	Cooling	3.75	4.71	5.55
	Nominal Heating	3.22	3.77	4.33
	Max. Heating	3.99	5.04	5.32
EER	Cooling	3.22	2.97	2.72
	Nominal Heating	3.75	3.71	3.48
	Max. Heating	3.40	3.17	3.10
SEER	Cooling	5.83	5.58	5.47
	Heating	3.82	3.96	3.99
SCOP	Cooling	5.83	5.58	5.47
	Heating	3.82	3.96	3.99
ηc	Cooling	230.2	220.2	215.8
	Heating	149.8	155.4	156.6
ηh	Cooling	149.8	155.4	156.6
	Heating	230.2	220.2	215.8
Airflow rate		4,240	4,400	4,400
Sound pressure level/Power level	Cooling	53 / 67	53 / 69	54 / 70
	Heating	54 / 68	56 / 69	56 / 70
Heat exchanger fin		Blue fin	Blue fin	Blue fin
Net Dimensions	Height	998	998	998
	Width	970	970	970
	Depth	370	370	370
Weight		88	88	88
		kg		
Refrigerant	Type (Global Warming Potential)	R410A (2,088)	R410A (2,088)	R410A (2,088)
	Charge	kg (CO2eq-T)	4.0 (8.4)	4.0 (8.4)
Connection pipe diameter	Liquid	9.52	9.52	9.52
	Gas	15.88	15.88	15.88
Total pipe length		80	80	80
Max. height difference		30	30	30
Operating Range	Cooling	-5 to 46	-5 to 46	-5 to 46
	Heating	-20 to 21	-20 to 21	-20 to 21

Note: Specifications are based on the following conditions.

Cooling: Indoor temperature of 27°CDB/19°CWB, and outdoor temperature of 35°CDB/24°CWB.
Heating: Indoor temperature of 20°CDB/15°CWB, and outdoor temperature of 7°CDB/6°CWB.
Pipe length: 7.5 m; Height difference between outdoor unit and indoor unit: 0 m.
The protective function may work when using it outside the operation range.

Dimensions

(Unit: mm)

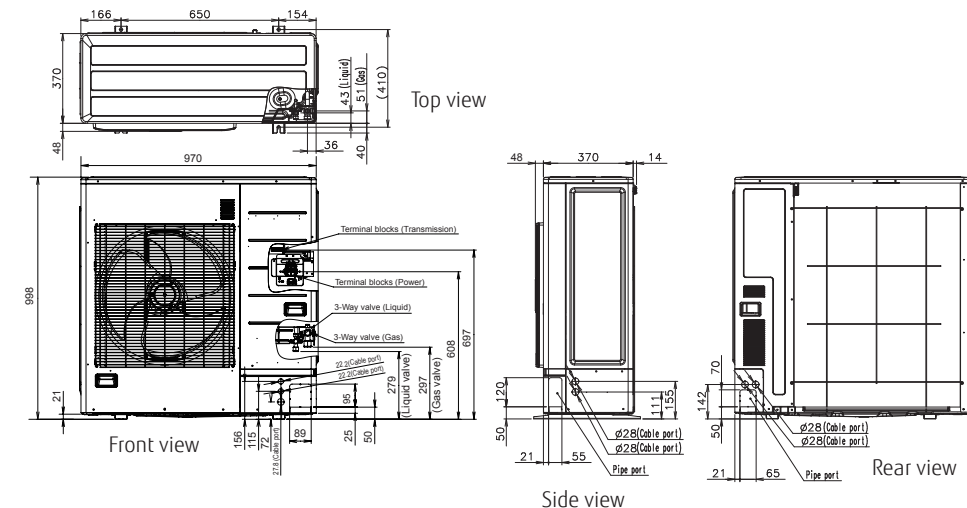

Heat Recovery

Modular Type

VRF VR-IV

Highly energy-efficient operation

Our heat recovery systems achieve high operating energy efficiency by drawing heat from the room to be cooled and transferring it as energy for rooms that are to be heated.

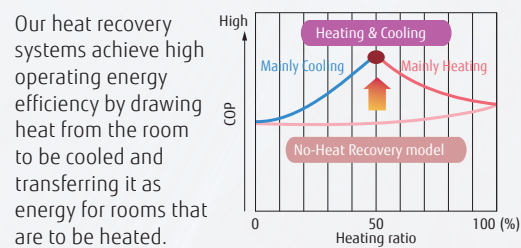
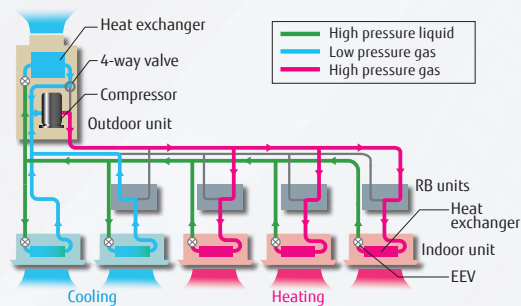

New intelligent refrigerant control

Fujitsu General is proposing outdoor units equipped with refrigerant control function. The refrigerant control operates with suitable control corresponding to the heat load of the room and offers a more comfortable environment. The refrigerant control can also provide increased energy savings.

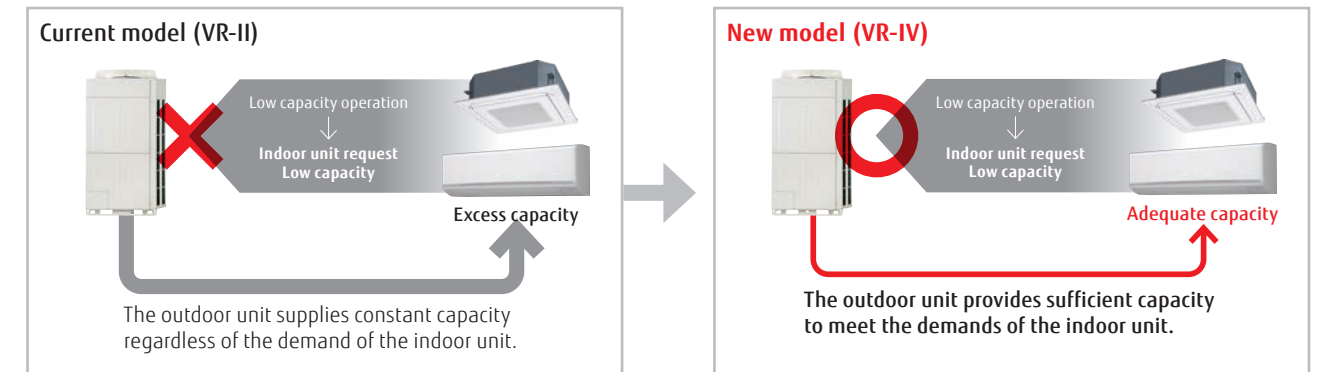

* The improvements due to the control and the actual sine wave vary depending on the combination of the indoor unit and system operating conditions.

Increase in the number of connectable indoor units

Capacity range of connectable indoor units

New model (VR-IV)	25%* to 150%
Current model (VR-II)	50% to 150%

*: For modular type, 25% to 49.9% operation in the entire system is available. (by one unit operation)

Increased number of connectable indoor units and space saving combinations

HP	10	12	14	16	...	28	30	32	...	48	
New model (VR-IV)	21	26	30	34	...	60	64	64	...	64	
Current model (VR-II)	15	16	17	21	24	...	42	45	48	...	64

The energy-saving technology that boosted operation efficiency

- Powerful large propeller fan**
The fan uses CFD* technology to achieve both high performance and low noise operation.
*CFD: Computational Fluid Dynamics
- 3-phase DC fan motor**
The use of a DC fan motor with sophisticated driver control improves energy efficiency substantially. In addition, this motor operates quietly.
- Subcooling heat exchanger**
High heat exchange efficiency is achieved by using an internal projection-shape double-pipe construction.
- High-efficient, large-capacity DC twin-rotary compressor**
Large-capacity high-efficient DC twin-rotary compressor with excellent intermediate capability.
- Sine-wave DC inverter control**
High-efficiency is realized by the adoption of reduced switching loss IPM.
- 4-face heat exchanger**
The 4-face heat exchanger increases the effective surface area and significantly improves heat-exchanging efficiency.
- Front intake port (Corner cut air inlet structure)**
In multiple outdoor unit installations, the unique front intake design improves airflow into the heat exchanger.

Extended connection ratio (applicable to multiple tenants)

Especially useful when starting partial air conditioning in a building under construction
Installation can be added flexibly for each tenant.



Stand-alone

Current model (VR-II)

Example) 50% of 12HP minimum connected indoor unit capacity is required

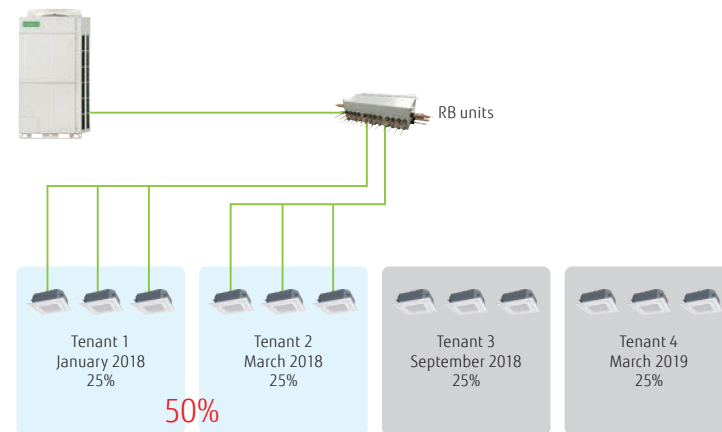

Installation is possible even for tenants who have not yet started operations.

New model (VR-IV)

Example) 25% of 12HP minimum connected indoor unit capacity is required

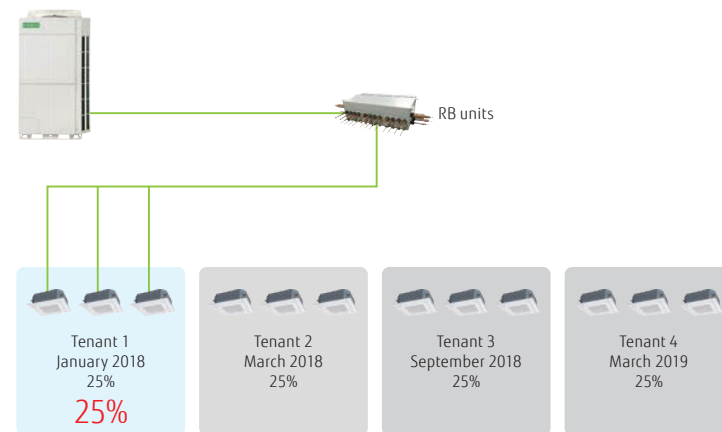

Installation and commissioning can be added flexibly to meet the opening dates of other tenants.

Modular type

One outdoor unit operates effectively for the capacities of connectable indoor units in the entire system. (Each of the multiple outdoor units does not dare operate at 25% capacity: any one of the outdoor units will operate at 50% and the remaining units will each output 0%, i.e., stop operating.)

Example: One 10HP outdoor unit performs 25% of the total 20HP outdoor units system.

One 10HP outdoor unit performs 50% of its capacity
→ Two outdoor units do not perform 25% of the operation.

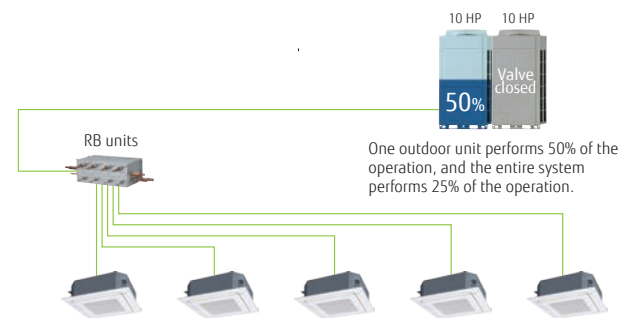

Additional installation is possible without changing the main pipe.

A main pipe of a diameter that can be used for the final system is installed at the beginning of the installation.
Duplication of the work will be avoided as there is no need to change the main pipe as in the previous model.

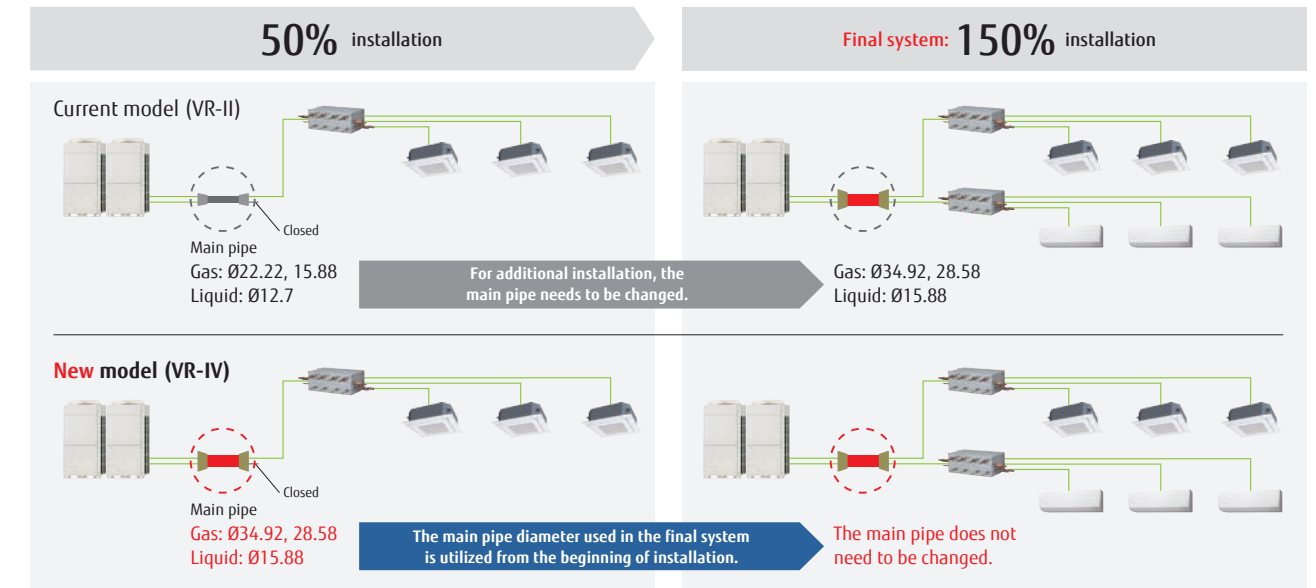

All-inverter compressor

Large-capacity DC inverter compressor

Large-capacity high-efficient DC twin-rotary compressor with excellent intermediate capability.



High-efficiency compressor speed control

The compressor speed control in 0.1 Hz increments ensures a comfortable space with less change in room temperature and less energy loss.

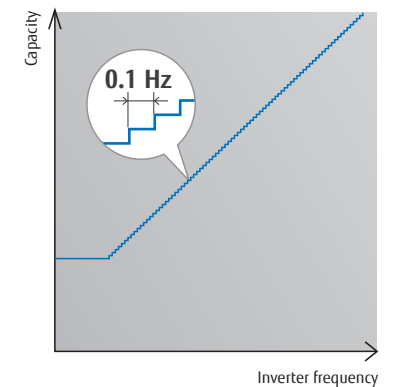

Efficiency in actual operating conditions

Class-leading high COP (Maximum) The use of our proprietary heat exchanger structure and high-efficiency DC twin-rotary compressors achieves the class-leading coefficient of performance (COP) in every combination.

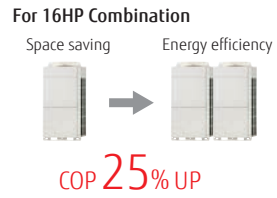
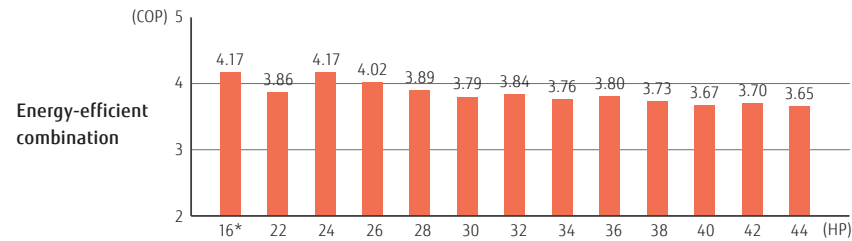
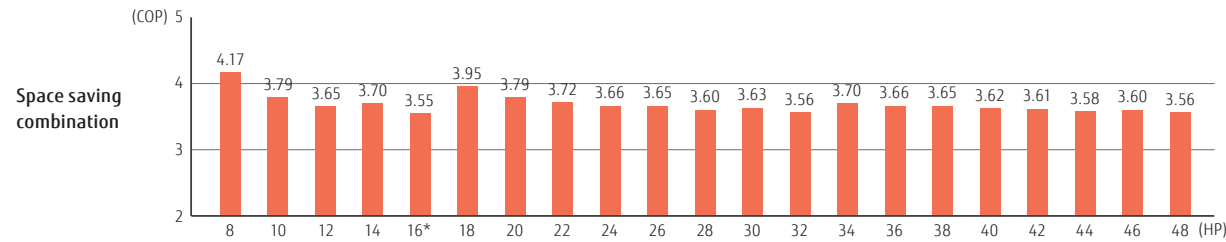

* These specifications are determined by Cassette combination.
 * Multiple outdoor units are not certified by Eurovent.

Multiple outdoor operation control

When multiple outdoor units are connected, each compressor carries out sophisticated operation. Instead of operating one compressor at full load to distribute the refrigerant to one heat exchanger, all compressors operate at partial load to distribute the refrigerant to all heat exchangers, thereby improving the efficiency of the entire system.

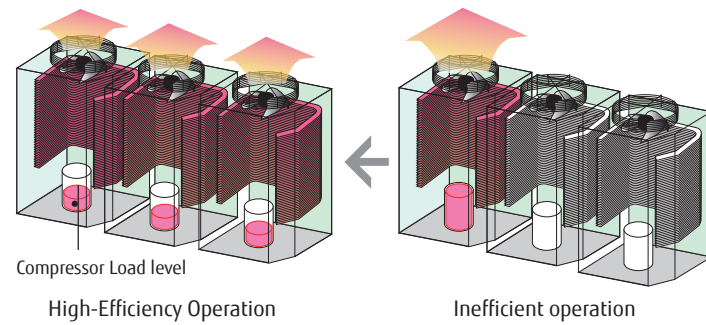

Heat exchanger refrigerant control

The heat exchanger in the outdoor unit is divided into two parts, upper and lower. The efficiency of the heat exchanger has been improved by adopting an optimum refrigerant path control where the refrigerant is distributed more into the top heat exchanger as this is where there is a greater air flow intake.

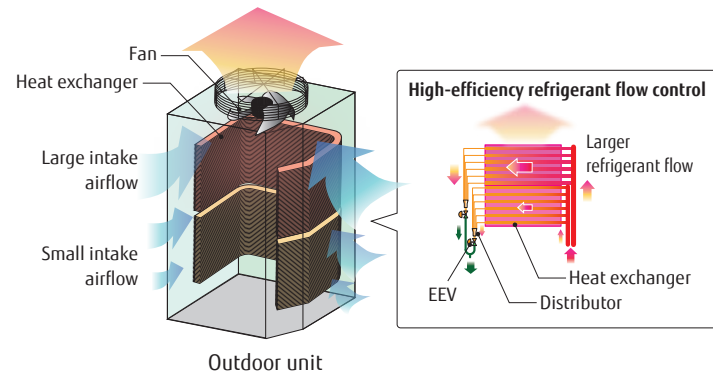

Flexible pipe connection

More flexible refrigerant pipe work is possible due to the use of various piping and RB unit connections, for adjustments to the floor layout and building structure.

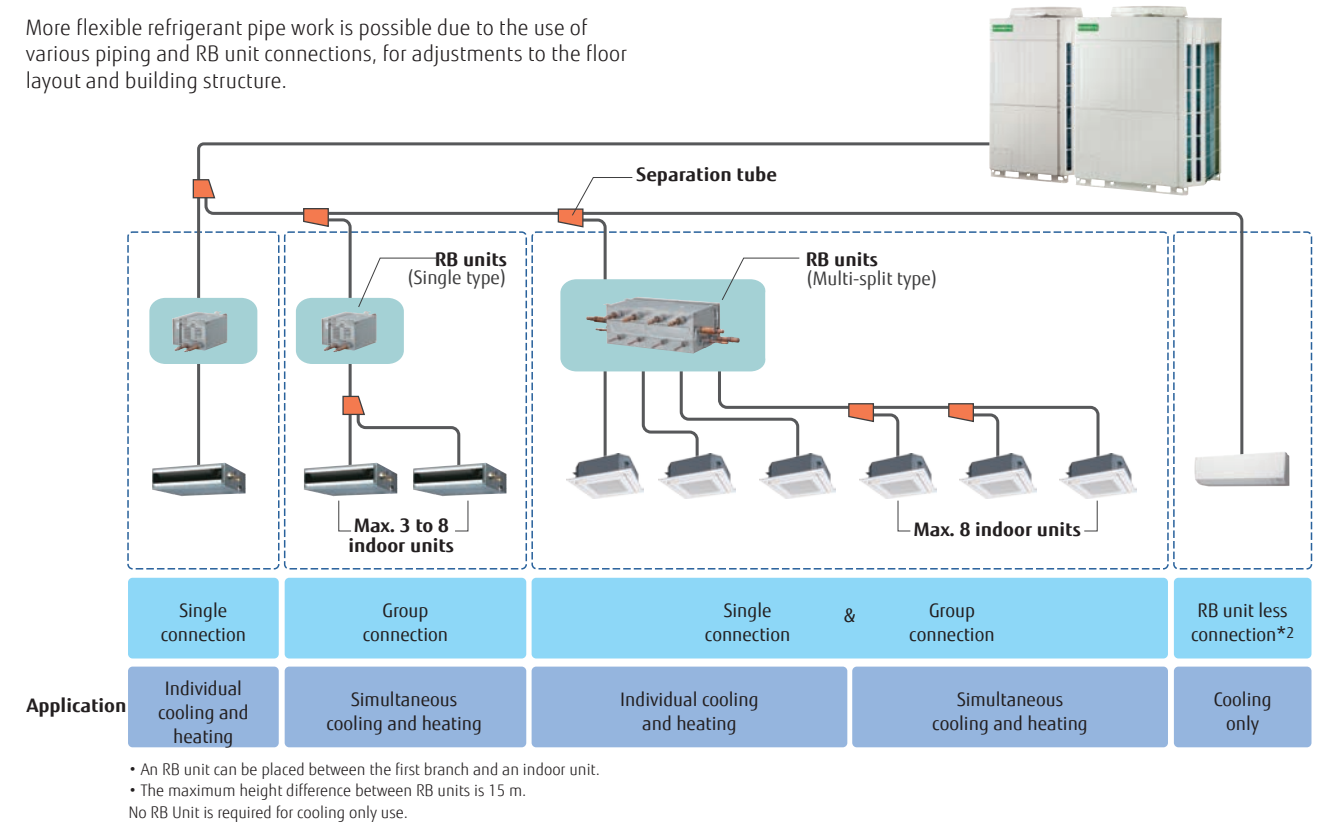

Flexible installation of RB unit

Small and slim design with a height of 198 mm makes it easy to install in tight spaces with height constraints.

- A drain pipe is not required.
- Different positions of a control box can be chosen to accommodate installation conditions.
- Series connection for simplified installation

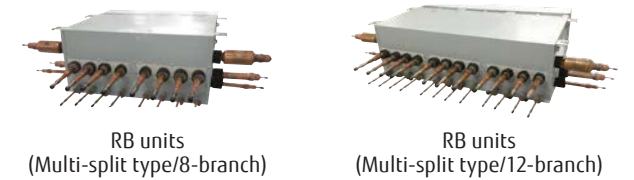
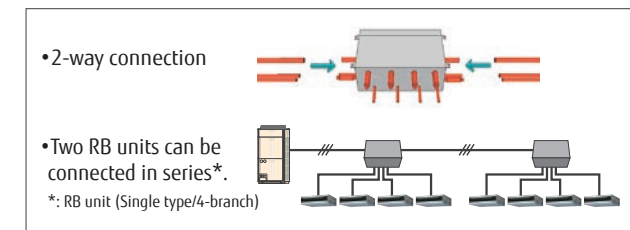
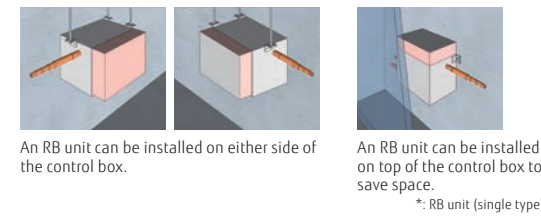

Easy maintenance in tight spaces

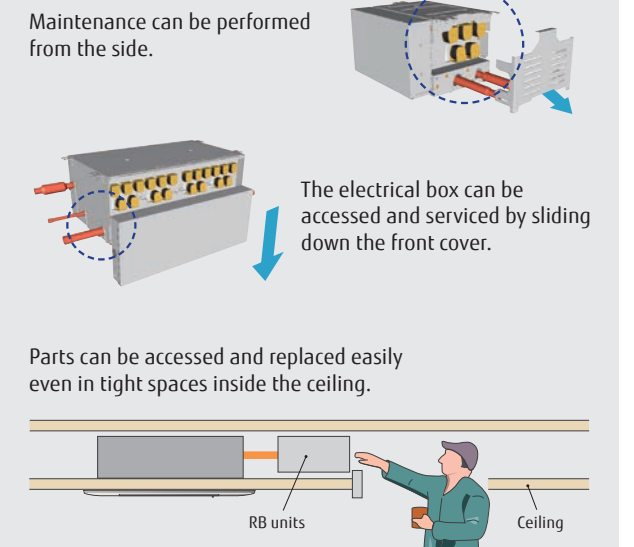

Outdoor units lineup • Combinations other than those listed below are not recommended.

Space saving combination

22.4kW (8HP) AJH072GALDH UNIT : AJH072GALDH	28.0kW (10HP) AJH090GALDH UNIT : AJH090GALDH	33.5kW (12HP) AJH108GALDH UNIT : AJH108GALDH	40.0kW (14HP) AJH126GALDH UNIT : AJH126GALDH	45.0kW (16HP) AJH144GALDH UNIT : AJH144GALDH
50.4kW (18HP) AJH162GALDH UNIT : AJH090/072GALDH	56.0kW (20HP) AJH180GALDH UNIT : AJH090/090GALDH	61.5kW (22HP) AJH198GALDH UNIT : AJH108/090GALDH	67.0kW (24HP) AJH216GALDH UNIT : AJH108/108GALDH	73.0kW (26HP) AJH234GALDH UNIT : AJH144/090GALDH
78.5kW (28HP) AJH252GALDH UNIT : AJH144/108GALDH	85.0kW (30HP) AJH270GALDH UNIT : AJH144/126GALDH	90.0kW (32HP) AJH288GALDH UNIT : AJH144/144GALDH	95.0kW (34HP) AJH306GALDH UNIT : AJH108/108/090GALDH	100.5kW (36HP) AJH324GALDH UNIT : AJH108/108/108GALDH
106.5kW (38HP) AJH342GALDH UNIT : AJH144/108/090GALDH	112.0kW (40HP) AJH360GALDH UNIT : AJH144/108/108GALDH	118.0kW (42HP) AJH378GALDH UNIT : AJH144/144/090GALDH	123.5kW (44HP) AJH396GALDH UNIT : AJH144/144/108GALDH	130.0kW (46HP) AJH414GALDH UNIT : AJH144/144/126GALDH
135.0kW (48HP) AJH432GALDH UNIT : AJH144/144/144GALDH				

Energy efficiency combination

44.8kW (16HP) AJH144GALDHH UNIT : AJH072/072GALDH	62.4kW (22HP) AJH198GALDHH UNIT : AJH126/072GALDH	67.2kW (24HP) AJH216GALDHH UNIT : AJH072/072/072GALDH	72.8kW (26HP) AJH234GALDHH UNIT : AJH090/072/072GALDH	78.4kW (28HP) AJH252GALDHH UNIT : AJH090/090/072GALDH
84.0kW (30HP) AJH270GALDHH UNIT : AJH090/090/090GALDH	90.4kW (32HP) AJH288GALDHH UNIT : AJH126/090/072GALDH	96.0kW (34HP) AJH306GALDHH UNIT : AJH126/090/090GALDH	102.4kW (36HP) AJH324GALDHH UNIT : AJH126/126/072GALDH	108.0kW (38HP) AJH342GALDHH UNIT : AJH126/126/090GALDH
113.0kW (40HP) AJH360GALDHH UNIT : AJH144/126/090GALDH	120.0kW (42HP) AJH378GALDHH UNIT : AJH126/126/126GALDH	125.0kW (44HP) AJH396GALDHH UNIT : AJH144/126/126GALDH		

8,10,12HP : AJH072GALDH / AJH090GALDH / AJH108GALDH
14,16HP : AJH126GALDH / AJH144GALDH



Dimensions

(Unit: mm)

8, 10, 12 HP

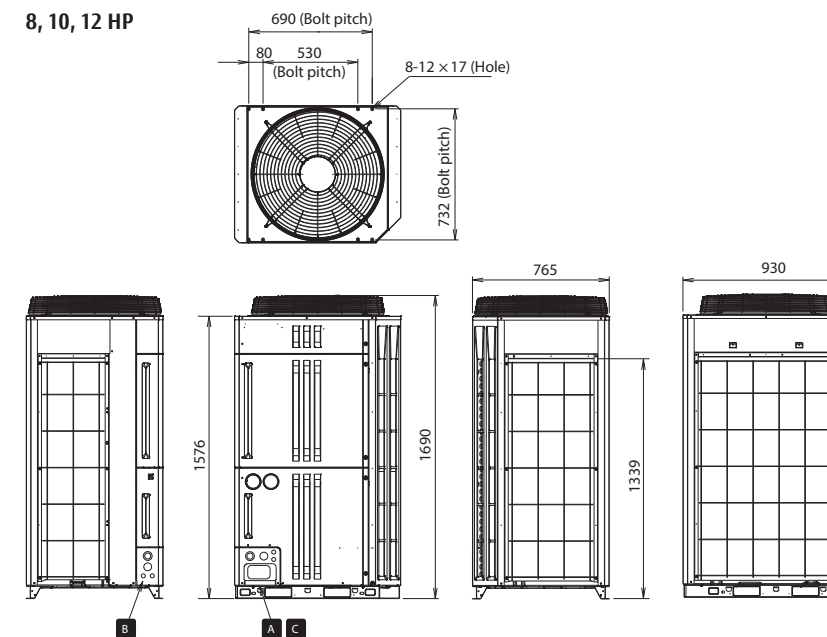

14, 16 HP

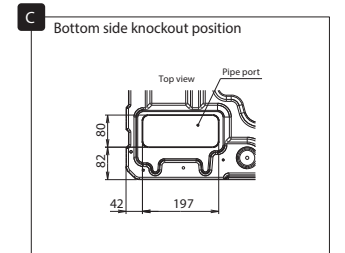
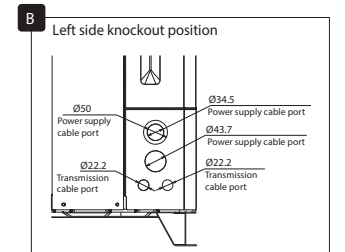
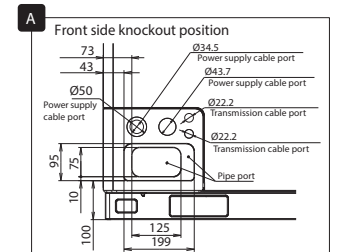
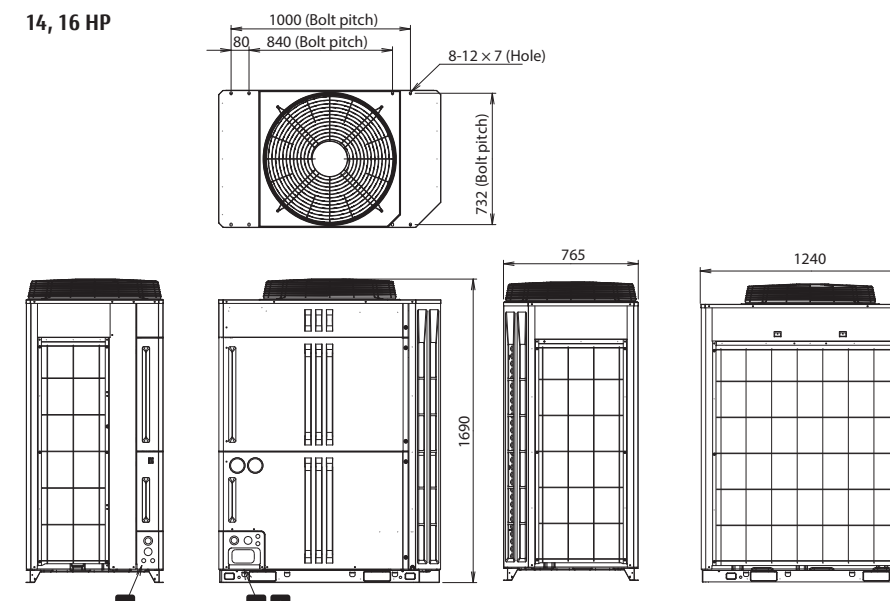

Outdoor unit specifications

Space saving combination

Rated capacity range		HP	8	10	12	14	16	18	20	22	24	26	28	30	32	34	36	38	40	42	44	46	48	
Model name			AJH072GALDH	AJH090GALDH	AJH108GALDH	AJH126GALDH	AJH144GALDH	AJH162GALDH	AJH180GALDH	AJH198GALDH	AJH216GALDH	AJH234GALDH	AJH252GALDH	AJH270GALDH	AJH288GALDH	AJH306GALDH	AJH324GALDH	AJH342GALDH	AJH360GALDH	AJH378GALDH	AJH396GALDH	AJH414GALDH	AJH432GALDH	
Unit 1 Unit 2 Unit 3			AJH072GALDH	AJH090GALDH	AJH108GALDH	AJH126GALDH	AJH144GALDH	AJH090GALDH AJH072GALDH	AJH090GALDH AJH090GALDH	AJH108GALDH AJH090GALDH	AJH108GALDH AJH126GALDH	AJH144GALDH AJH108GALDH	AJH144GALDH AJH108GALDH	AJH144GALDH AJH126GALDH	AJH144GALDH AJH144GALDH	AJH108GALDH AJH108GALDH AJH090GALDH	AJH108GALDH AJH108GALDH AJH108GALDH	AJH144GALDH AJH108GALDH AJH108GALDH	AJH144GALDH AJH108GALDH AJH108GALDH	AJH144GALDH AJH108GALDH AJH108GALDH	AJH144GALDH AJH108GALDH AJH108GALDH	AJH144GALDH AJH144GALDH AJH126GALDH	AJH144GALDH AJH144GALDH AJH144GALDH	
Maximum connectable indoor units*			17	21	26	30	34	39	43	47	52	56	60	64	64	64	64	64	64	64	64	64	64	
Connectable capacity range of indoor units		kW	5.6-33.6	7.0-42.0	8.4-50.2	10.0-60.0	11.3-67.5	12.6-75.6*3	14.0-84.0*3	15.4-92.2*3	16.8-100.5*3	18.3-109.5*3	19.7-117.7*3	21.3-127.5*3	22.5-135.0*3	23.8-142.5*3	25.2-150.7*3	26.7-159.7*3	28.0-168.0*3	29.5-177.0*3	30.9-185.2*3	32.5-195.0*3	33.8-202.5*3	
Power source			3-phase, 4-wire, 400 V, 50Hz										3-phase, 4-wire, 400 V, 50Hz											
Capacity		Cooling Nominal Heating Max. Heating	kW																					
Input power		Cooling Nominal Heating Max. Heating	kW																					
EER		Cooling	W/W																					
COP		Nominal Heating Max. Heating	W/W																					
SEER		Cooling	W/W																					
SCOP		Heating	W/W																					
ηc		Cooling	%																					
ηh		Heating	%																					
Air flow rate		High	m³/h																					
Sound pressure level**/ Power level		Cooling Heating	dB(A)																					
Max. External static pressure			Pa																					
Compressor motor output			kW																					
Heat exchanger fin			Blue fin																					
Net Dimensions		Height Width Depth	mm																					
Weight			kg																					
Refrigerant		Type (Global Warming Potential) Charge Liquid Discharge Gas Suction Gas	kg (CO2eq-1)																					
Connection pipe diameter			mm																					
Operating Range		Cooling Heating Cooling/Heating	°CDB																					

Energy Efficiency Combination

Rated capacity range		HP	16	22	24	26	28	30	32	34	36	38	40	42	44		
Model name			AJH144GALDHH	AJH198GALDHH	AJH216GALDHH	AJH234GALDHH	AJH252GALDHH	AJH270GALDHH	AJH288GALDHH	AJH306GALDHH	AJH324GALDHH	AJH342GALDHH	AJH360GALDHH	AJH378GALDHH	AJH396GALDHH		
Unit 1 Unit 2 Unit 3			AJH072GALDH AJH072GALDH	AJH126GALDH AJH072GALDH	AJH072GALDH AJH072GALDH AJH072GALDH	AJH090GALDH AJH072GALDH AJH072GALDH	AJH090GALDH AJH090GALDH AJH072GALDH	AJH090GALDH AJH090GALDH AJH090GALDH	AJH126GALDH AJH090GALDH AJH090GALDH	AJH126GALDH AJH090GALDH AJH090GALDH	AJH126GALDH AJH126GALDH AJH072GALDH	AJH126GALDH AJH126GALDH AJH090GALDH	AJH126GALDH AJH126GALDH AJH090GALDH	AJH126GALDH AJH126GALDH AJH126GALDH	AJH126GALDH AJH126GALDH AJH126GALDH		
Maximum connectable indoor units*			34	47	52	56	60	64	64	64	64	64	64	64			
Connectable capacity range of indoor units		kW	11.2-67.2*3	15.6-93.6*3	16.8-100.8*3	18.2-109.2*3	19.6-117.6*3	21.0-126.0*3	22.6-135.6*3	24.0-144.0*3	25.6-153.6*3	27.0-162.0*3	28.3-169.5*3	30.0-180.0*3	31.3-187.5*3		
Power source			3-phase, 4-wire, 400 V, 50Hz								3-phase, 4-wire, 400 V, 50Hz						
Capacity		Cooling Nominal Heating Max. Heating	kW														
Input power		Cooling Nominal Heating Max. Heating	kW														
EER		Cooling	W/W														
COP		Nominal Heating Max. Heating	W/W														
SEER		Cooling	W/W														
SCOP		Heating	W/W														
ηc		Cooling	%														
ηh		Heating	%														
Air flow rate		High	m³/h														
Sound pressure level**/ Power level		Cooling Heating	dB(A)														
Max. External static pressure			Pa														
Compressor motor output			kW														
Heat exchanger fin			Blue fin														
Net Dimensions		Height Width Depth	mm														
Weight			kg														
Refrigerant		Type (Global Warming Potential) Charge Liquid Discharge Gas Suction Gas	kg (CO2eq-1)														
Connection pipe diameter			mm														
Operating Range		Cooling Heating Cooling/Heating	°CDB														

Note: Specifications are based on the following conditions.
 Cooling: Indoor temperature of 27°CDB/19°CWB, and outdoor temperature of 35°CDB/24°CWB.
 Heating: Indoor temperature of 20°CDB/15°CWB, and outdoor temperature of 7°CDB/6°CWB.
 Pipe length: 7.5 m; Height difference between outdoor unit and indoor unit: 0 m.
 * Multiple outdoor units are not certified by Eurovent.

*1: Minimum connectable indoor unit number is 2.
 *2: The noise level is the value measured in an anechoic room. When measured in an actual installation, the measured value is typically larger than the indicated value due to ambient noise and reflections.
 *3: If the capacity range of the connectable indoor units is between 25% and 49.9%, do not open the three-way valve except for the unit to be operated. In addition, do not connect the power line.

Heat Pump

Modular Type

VRF V-IV

System configuration example

- Suitable for air conditioning midsize and large buildings. Connecting each outdoor unit makes it possible to create a high-capacity system.
- Multiple indoor units are connected with separation tubes and headers.

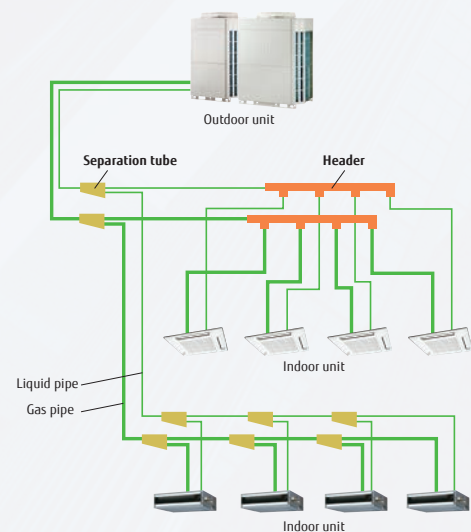

New intelligent refrigerant control

Fujitsu General is proposing outdoor units equipped with refrigerant control function. The refrigerant control operates with subtle control corresponding to the heat load of the room and offers a more comfortable environment. The refrigerant control can also provide increased energy savings.

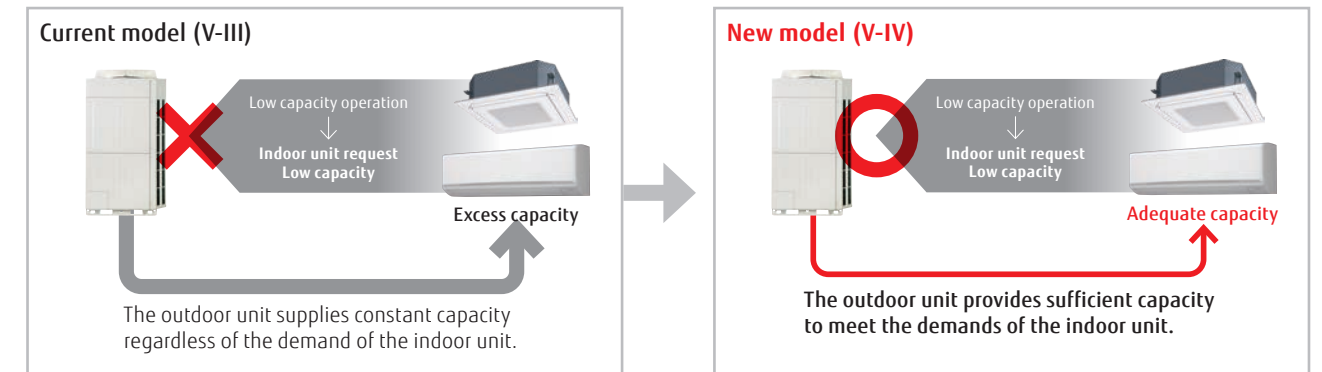

* The improvements due to the control and the actual sine wave vary depending on the combination of the indoor unit and system operating conditions.

Efficiency in actual operating conditions

The use of our proprietary heat exchanger structure and high-efficiency DC twin-rotary compressors achieves the class-leading coefficient of performance (COP) in every combination.

Space saving combination

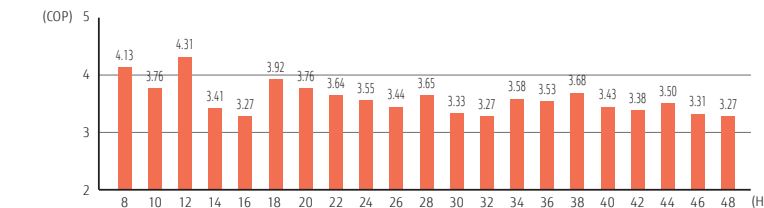

Energy efficiency combination

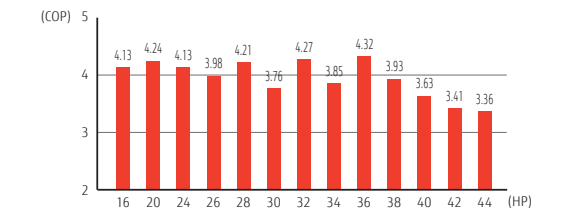

* These specifications are determined by Cassette combination. *Multiple outdoor units are not certified by Eurovent.

The energy-saving technology that boosted operation efficiency

- Powerful large propeller fan**
The fan uses CFD* technology to achieve both high performance and low noise operation. *CFD: Computational Fluid Dynamics
- 3-phase DC fan motor**
The use of a DC fan motor with sophisticated driver control improves energy efficiency substantially. In addition, low noise is realized by the DC fan motor.
- Sine-wave DC inverter control**
High-efficiency is realized by the adoption of reduced switching loss IPM.
- 4-face heat exchanger**
The 4-face heat exchanger increases the effective surface area and significantly improves heat-exchanging efficiency.
- Subcooling heat exchanger**
High heat exchange efficiency is achieved by using an internal projection-shape double-pipe construction.
- High-efficient, large-capacity DC twin-rotary compressor**
Large-capacity high-efficient DC twin-rotary compressor with excellent intermediate capability.
- Front intake port (Corner cut air inlet structure)**
In multiple outdoor unit installations, the unique front intake design improves airflow into the heat exchanger.

Outdoor units lineup • Combinations other than those listed below are not recommended.

Space saving combination

22.4 kW (8 HP) AJH072LALDH UNIT: AJH072LALDH	28.0 kW (10 HP) AJH090LALDH UNIT: AJH090LALDH	33.5 kW (12 HP) AJH108LALDH UNIT: AJH108LALDH	40.0 kW (14 HP) AJH126LALDH UNIT: AJH126LALDH	45.0 kW (16 HP) AJH144LALDH UNIT: AJH144LALDH
50.4 kW (18 HP) AJH162LALDH UNIT: AJH090/072LALDH	56.0 kW (20 HP) AJH180LALDH UNIT: AJH090/090LALDH	62.4 kW (22 HP) AJH198LALDH UNIT: AJH126/072LALDH	68.0 kW (24 HP) AJH216LALDH UNIT: AJH126/090LALDH	73.0 kW (26 HP) AJH234LALDH UNIT: AJH144/090LALDH
78.5 kW (28 HP) AJH252LALDH UNIT: AJH144/108LALDH	85.0 kW (30 HP) AJH270LALDH UNIT: AJH144/126LALDH	90.0 kW (32 HP) AJH288LALDH UNIT: AJH144/144LALDH	95.4 kW (34 HP) AJH306LALDH UNIT: AJH144/090/072LALDH	101.0 kW (36 HP) AJH324LALDH UNIT: AJH144/090/090LALDH
106.5 kW (38 HP) AJH342LALDH UNIT: AJH144/108/090LALDH	113.0 kW (40 HP) AJH360LALDH UNIT: AJH144/126/090LALDH	118.0 kW (42 HP) AJH378LALDH UNIT: AJH144/144/090LALDH	123.5 kW (44 HP) AJH396LALDH UNIT: AJH144/144/108LALDH	130.0 kW (46 HP) AJH414LALDH UNIT: AJH144/144/126LALDH
135.0 kW (48 HP) AJH432LALDH UNIT: AJH144/144/144LALDH				

Energy efficiency combination

44.8 kW (16 HP) AJH144LALDHH UNIT: AJH072/072LALDH	55.9 kW (20 HP) AJH180LALDHH UNIT: AJH108/072LALDH	67.2 kW (24 HP) AJH216LALDHH UNIT: AJH072/072/072LALDH	72.8 kW (26 HP) AJH234LALDHH UNIT: AJH090/072/072LALDH	78.3 kW (28 HP) AJH252LALDHH UNIT: AJH108/072/072LALDH
84.8 kW (30 HP) AJH270LALDHH UNIT: AJH126/072/072LALDH	89.4 kW (32 HP) AJH288LALDHH UNIT: AJH108/108/072LALDH	95.9 kW (34 HP) AJH306LALDHH UNIT: AJH126/108/072LALDH	100.5 kW (36 HP) AJH324LALDHH UNIT: AJH108/108/108LALDH	107.0 kW (38 HP) AJH342LALDHH UNIT: AJH126/108/108LALDH
113.5 kW (40 HP) AJH360LALDHH UNIT: AJH126/126/108LALDH	120.0 kW (42 HP) AJH378LALDHH UNIT: AJH126/126/126LALDH	125.0 kW (44 HP) AJH396LALDHH UNIT: AJH144/126/126LALDH		

8, 10 HP: AJH072LALDH / AJH090LALDH
12, 14, 16 HP: AJH108LALDH / AJH126LALDH / AJH144LALDH



8, 10 HP

12, 14, 16 HP

Dimensions

(Unit: mm)

8, 10 HP

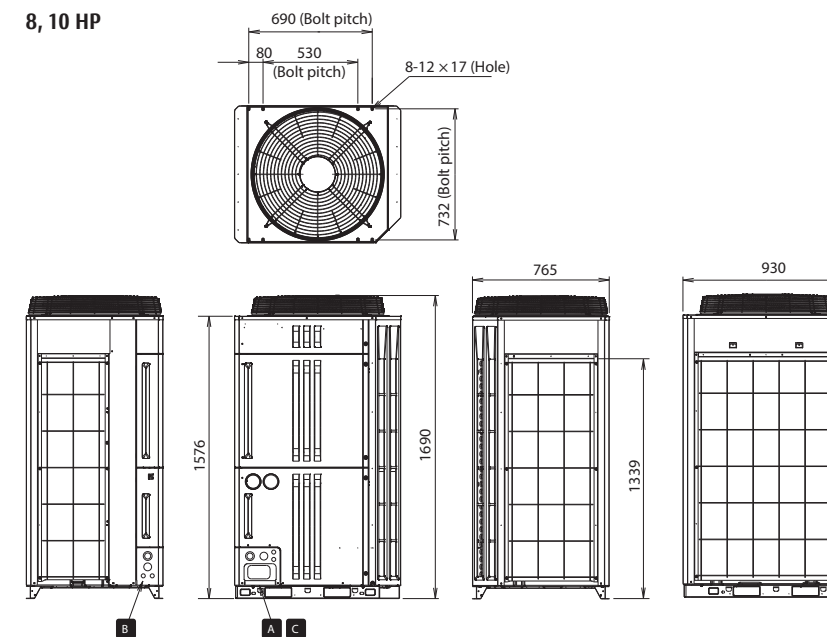

12, 14, 16 HP

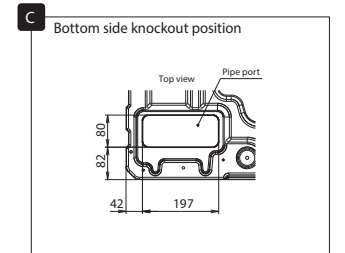
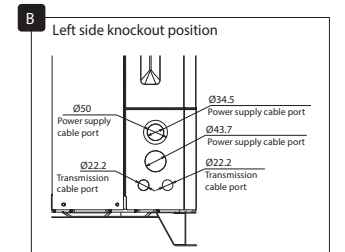
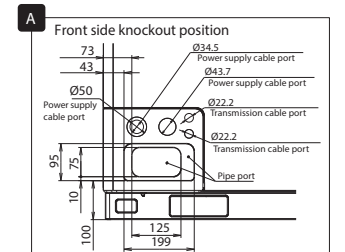
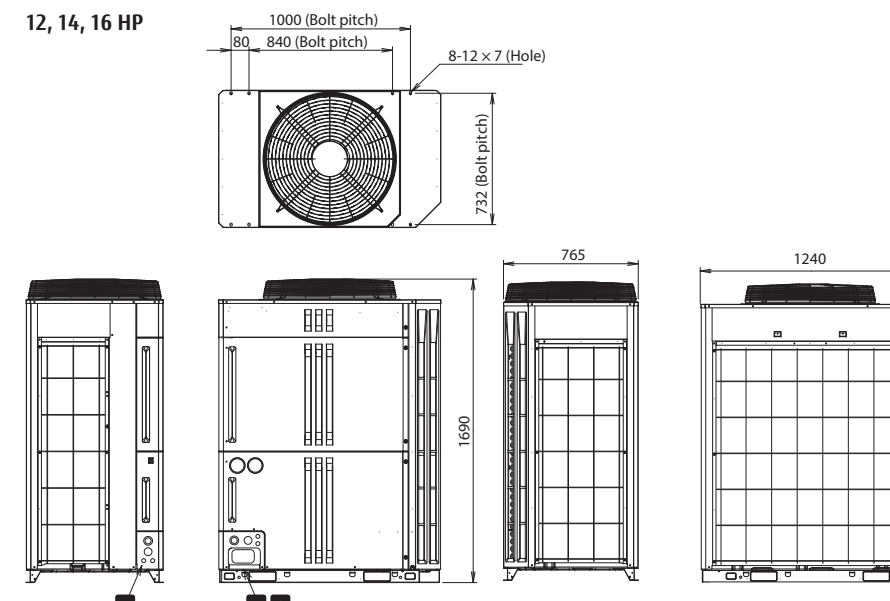

Outdoor unit specifications

Space saving combination

Table with 22 columns for capacity (8 to 48 HP) and rows for capacity, input power, EER, COP, SEER, SCOP, ηc, ηh, Air flow rate, Sound pressure level, Power level, Max. External static pressure, Compressor motor output, Heat exchanger fin, Net Dimensions, Weight, Refrigerant, Connection pipe diameter, Operating Range.

Energy Efficiency Combination

Table with 13 columns for capacity (16 to 44 HP) and rows for capacity, input power, EER, COP, SEER, SCOP, ηc, ηh, Air flow rate, Sound pressure level, Power level, Max. External static pressure, Compressor motor output, Heat exchanger fin, Net Dimensions, Weight, Refrigerant, Connection pipe diameter, Operating Range.

Note: Specifications are subject to the following conditions: Cooling: Indoor temperature of 27°CDB/19°CWB, and outdoor temperature of 35°CDB/24°CWB. Heating: Indoor temperature of 20°CDB/15°CWB, and outdoor temperature of 7°CDB/6°CWB. Pipe length: 7.5 m; Height difference between outdoor unit and indoor unit: 0 m.

When cooling operation is conducted at an outdoor air temperature below -5°C, the outdoor unit must be installed in a position that is higher than or equal to that of the indoor units. * These specifications are determined by ducted combination. *Multiple outdoor units are not certified by Eurovent.

*1 Minimum connectable indoor unit number is 2. However, the ARXC72 and ARXC90 can be used with a signal connection. *2 The noise level is the value measured in an anechoic room.

When measured in an actual installation, the measured value is typically larger than the indicated value due to ambient noise and reflections. * These specifications are determined by ducted combination.

VRF INDOOR UNITS

















17 types and 95 models available to meet the requirements of any building design.

Indoor units for the VRF Systems are compact, highly efficient, quiet, and user-friendly. Fujitsu General offers a variety of types and capacities for its indoor units that are easy to install and maintain. In addition, a variety of optional parts are available to provide an even more desirable air conditioning experience to users.

- V-054 INDOOR UNITS LINEUP
- V-056 Compact Cassette (Grid type)
- V-058 Cassette Slim type (Circular Flow)
- V-060 Cassette Large type (Circular Flow)
- V-062 Cassette (One-way Flow type)
- V-064 3D Flow Cassette
- V-066 Low Static Pressure Duct/Mini Duct
- V-068 Low Static Pressure Duct/Slim Duct/Slim Concealed Floor
- V-070 Low Static Pressure Duct
- V-072 Medium Static Pressure Duct
- V-074 High Static Pressure Duct
- V-076 Compact Floor
- V-078 Floor/Ceiling
- V-080 Ceiling
- V-082 Wall-mounted (EEV Internal/external)



VRF Indoor Unit Lineup

Capacity range (kW)			1.1	2.2	2.8	3.6		4.0	4.5	5.6	7.1	9.0	10.0	11.2	12.5	14.0	18.0	22.4	25.0	28.0			
Class			4	7	9	12		14	14	18	24	30	34	36	45	54	60	72	90	96			
Cassette	Compact type	Compact Grid type/Standard type		AUXB 004 GLEH	AUXB 007 GLEH	AUXB 009 GLEH	AUXB 012 GLEH		AUXB 014 GLEH	AUXB 018 GLEH	AUXB 024 GLEH												
	Slim type	Circular Flow								AUXM 018 GLEH	AUXM 024 GLEH	AUXM 030 GLEH											
	Large type	Circular Flow								AUXK 018 GLEH	AUXK 024 GLEH	AUXK 030 GLEH	AUXK 034 GLEH	AUXK 036 GLEH	AUXK 045 GLEH	AUXK 054 GLEH							
	One-way Flow type	One-way Flow		AUXV 004 GLEH	AUXV 007 GLEH	AUXV 009 GLEH	AUXV 012 GLEH		AUXV 014 GLEH	AUXV 018 GLEH	AUXV 024 GLEH												
	3D Flow type	3D Flow								AUXS 018 GLEH	AUXS 024 GLEH												
Duct	Low Static Pressure Duct	Mini Duct (With drain pump)		ARXK 004 GLGH	ARXK 007 GLGH	ARXK 009 GLGH	ARXK 012 GLGH		ARXK 014 GLGH	ARXK 018 GLGH	ARXK 024 GLGH												
		Slim Duct (With drain pump)		ARXD 04 GALH*2	ARXD 007 GLEH	ARXD 009 GLEH	ARXD 012 GLEH		ARXD 014 GLEH	ARXD 018 GLEH	ARXD 024 GLEH												
		High Efficiency*3								ARXP 018 GLFH		ARXP 030 GLFH											
	Medium static pressure duct	Normal									ARXA 024 GLEH	ARXA 030 GLEH		ARXA 036 GLEH	ARXA 045 GLEH								
		High Static Pressure Duct	Normal												ARXC 036 GTEH	ARXC 045 GTEH		ARXC 060 GTEH*1	ARXC 072 GTEH*1	ARXC 090 GTEH*1	ARXC 096 GTEH*1		
Floor	Floor (*Same as Ceiling models)						ABHA 012 GTEH		ABHA 014 GTEH	ABHA 018 GTEH	ABHA 024 GTEH												
	Slim Concealed Floor (*Same as Slim Duct models)			ARXD 04 GALH*2	ARXD 007 GLEH	ARXD 009 GLEH	ARXD 012 GLEH		ARXD 014 GLEH	ARXD 018 GLEH	ARXD 024 GLEH												
	Compact Floor			AGHA 004 GCGH	AGHA 007 GCGH	AGHA 009 GCGH	AGHA 012 GCGH		AGHA 014 GCGH														
	Compact Floor (EEV external)			AGHE 004 GCEH	AGHE 007 GCEH	AGHE 009 GCEH	AGHE 012 GCEH		AGHE 014 GCEH														
			This model requires the EV kit to be connected.																				
Ceiling							ABHA 012 GTEH		ABHA 014 GTEH	ABHA 018 GTEH	ABHA 024 GTEH	ABHA 030 GTEH		ABHA 036 GTEH	ABHA 045 GTEH	ABHA 054 GTEH							
Wall-mounted type	Wall-mounted type			ASHA 004 GCGH	ASHA 007 GCGH	ASHA 009 GCGH	ASHA 012 GCGH		ASHA 014 GCGH		ASHA 18 GBCH	ASHA 24 GBCH	ASHA 030 GTEH	ASHA 034 GTEH									
	Wall-mounted type (EEV external)			ASHE 004 GCEH	ASHE 007 GCEH	ASHE 009 GCEH	ASHE 012 GCEH		ASHE 014 GCEH														
			This model requires the EV kit to be connected.																				

*1: ARXC060/072/090/096G cannot be connected to J-IVS/J-IV Series.
 *2: ARXD04GALH cannot be connected to J-IVS/J-IVL/VR-IV Series.
 *3: Production by order
 Specifications and design are subject to change without notice.

Compact Cassette Grid type



Compact and stylish panel

The compact and stylish panel fits nicely into a grid type ceiling. The linear design is a perfect fit into a grid of 620 mm × 620 mm in the ceiling.

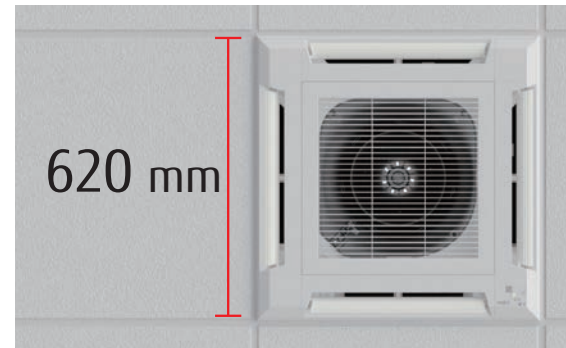

Easy maintenance

You can access the unit for maintenance just by removing a ceiling panel right next to the grille. As no inspection hole needs to be cut through the ceiling, no additional construction cost is incurred.



The air inlet grille can be installed to open in any direction for easy maintenance.



Flexible installation

The unit fits nicely into the decor of a grid type ceiling and can be installed near a lighting or a ventilation opening.



High ceiling mode

The cassette can be installed up to a height of 3.0 m. (012/014/018/024).

Model code	Maximum height from floor to ceiling (m)	
	Standard mode	High ceiling mode
004	2.7	-
007	2.7	-
009	2.7	-
012	2.7	3.0
014	2.7	3.0
018	2.7	3.0
024	2.7	3.0

Model: AUXB004GLEH / AUXB007GLEH / AUXB009GLEH
AUXB012GLEH / AUXB014GLEH / AUXB018GLEH
AUXB024GLEH



Specifications

Model name		AUXB004GLEH	AUXB007GLEH	AUXB009GLEH	AUXB012GLEH	AUXB014GLEH	AUXB018GLEH	AUXB024GLEH
Power source		Single phase, ~230 V, 50 Hz						
Capacity	Cooling	1.1	2.2	2.8	3.6	4.5	5.6	7.1
	Heating	1.3	2.8	3.2	4.1	5.0	6.3	8.0
Input power		23	25	25	29	35	36	84
Airflow rate	High	530/530	540	550	600	680	710	1,030
	Med-High	490/480	500	520	560	620	660	910
	Med	450/430	460	480	520	560	590	790
	Med-Low	420/380	420	440	480	500	520	680
	Low	390/340	390	400	430	440	460	560
Quiet		350/300	350	350	390	390	400	450
Sound pressure level	High	34/34	34	35	37	38	41	50
	Med-High	32/31	32	33	34	37	39	46
	Med	30/29	30	31	33	34	36	43
	Med-Low	28/26	28	29	31	32	33	39
	Low	27/24	27	27	29	30	30	35
Quiet		25/21	25	25	27	27	27	30
Net Dimensions (H × W × D)		mm	245 × 570 × 570	245 × 570 × 570	245 × 570 × 570	245 × 570 × 570	245 × 570 × 570	245 × 570 × 570
Weight		kg	14.5	15	15	15	17	17
Connection pipe diameter	Liquid (Flare)	mm	6.35	6.35	6.35	6.35	6.35	9.52
	Gas (Flare)	mm	9.52	9.52	9.52	12.70	12.70	15.88
Drain Hose Diameter (I.D./O.D.)			25/32					
Cassette Grille	Model name		UTG-UFGE-W/UTG-UFGE-W					
	Net Dimensions (H × W × D)	mm	50 × 620 × 620/50 × 700 × 700					
Weight		kg	2.3/2.6					

Note: Specifications are subject to the following conditions:
Cooling: Indoor temperature of 27°CDB/19°CWB, and outdoor temperature of 35°CDB/24°CWB.
Heating: Indoor temperature of 20°CDB/(15°CWB), and outdoor temperature of 7°CDB/6°CWB.
Pipe length: 7.5 m; Height difference between outdoor unit and indoor unit: 0 m. Voltage: 230 [V]
*1: This value is under cooling operation.

Optional parts

*For more details, please refer to the chapter "Optional parts".

Air Outlet Shutter Plate:	UTR-YDZB	Cassette Grille:	UTG-UFGE-W, UTG-UFGE-W
Fresh Air Intake Kit:	UTZ-VXAA	External power supply unit:	UTZ-GXXA, UTZ-GXXC*
Insulation kit for high humidity:	UTZ-KXGC	WLAN adapter:	UTY-TFSXZ1, UTY-TFSXJ3, FG-AC-WIFI21
Silver Ion Filter:	UTD-HFAA		

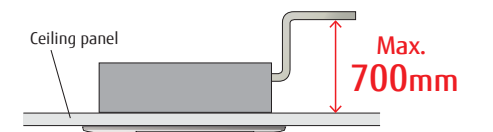

Dimensions

(Unit: mm)

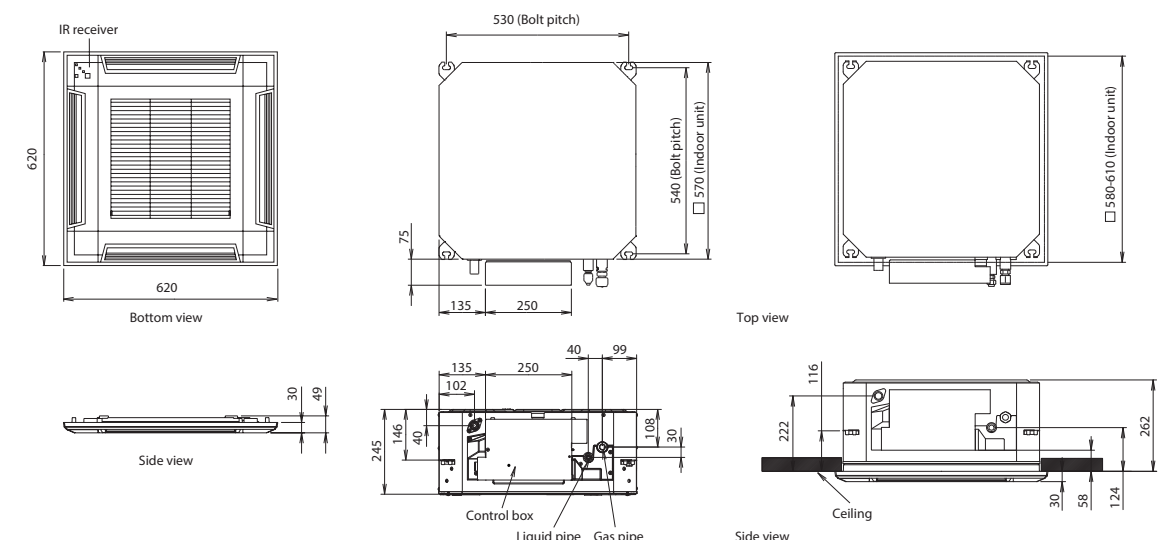

Cassette Slim type Circular Flow



Unique circular flow design

This Cassette type air conditioner is equipped with a high performance DC fan motor, a turbo fan, and a louver to propel powerful airflows in all directions.

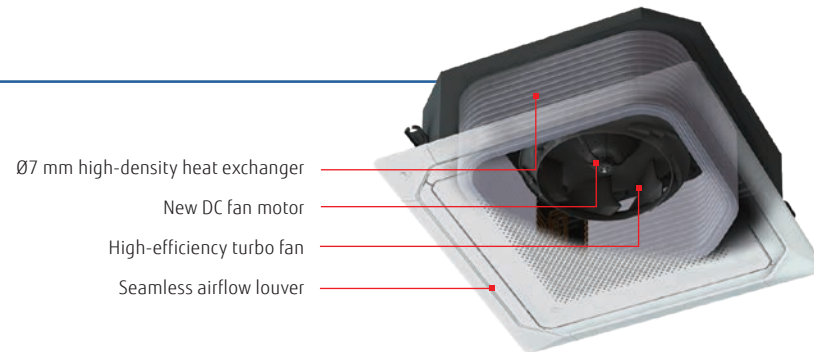

Uniform temperature air conditioning

Achieve a comfortable air conditioning spread to every corner of the room thanks to the circular flow and wide vertical airflow.

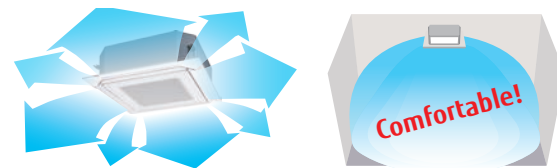

Individual louver control

Each louver can be set individually by the Touch panel wired remote controller so the user can enjoy the comfort of different directional airflows according to the room layout.

* UTY-RNRGZ5 Wired remote controller with touch panel and UTY-DCGGZ2 Central remote controller only



Comfortable air conditioning by preventing direct blowing of cold air and by providing swinging air flow simultaneously.

Provides efficient air conditioning based on the room layout

The Occupancy sensor contributes to further energy savings.

Energy saving operation starts automatically by detecting the motion of a person. Two modes of save operation mode and stop mode can be selected.

* UTY-RNRGZ5 Wired remote controller with touch panel and UTY-DCGGZ2 Central remote controller only



- 2 modes are available to choose from:
- Auto economy mode** The air conditioner switches to operate on reduced power when it detects that the room is unoccupied.
 - Auto-off mode** The air conditioner stops operating when it detects that the room is unoccupied.

Model: AUXM018GLEH / AUXM024GLEH / AUXM030GLEH



Specifications

Model name	AUXM018GLEH		AUXM024GLEH		AUXM030GLEH	
Power source	Single phase, ~230 V, 50 Hz					
Capacity	Cooling	kW	5.6	7.1	9.0	
	Heating	kW	6.3	8.0	10.0	
Input power		W	20	25	49	
Airflow rate	High	m ³ /h	1,050	1,120	1,470	
	Med-High	m ³ /h	930	1,050	1,160	
	Med	m ³ /h	900	930	1,070	
	Med-Low	m ³ /h	870	900	930	
	Low	m ³ /h	810	870	900	
	Quiet	m ³ /h	780	780	780	
Sound pressure level	High	dB(A)	33	35	40	
	Med-High	dB(A)	32	33	36	
	Med	dB(A)	31	32	34	
	Med-Low	dB(A)	30	31	32	
	Low	dB(A)	29	30	31	
	Quiet	dB(A)	28	28	28	
Dimensions (H × W × D)	mm		246 × 840 × 840			
Weight	kg		24.0	24.5	24.5	
Connection pipe diameter	Liquid (Flare)	mm	6.35	9.52	9.52	
	Gas (Flare)	mm	12.70	15.88	15.88	
Drain Hose Diameter (I.D./O.D.)			25/32			
Cassette Grille	Model name	UTG-UKGC-W/UTG-UKGA-B				
	Dimensions (H × W × D)	mm	53 × 950 × 950			
	Weight	kg	6.0			

Note: Specifications are subject to the following conditions:
 Cooling: Indoor temperature of 27°CDB/19°CWB, and outdoor temperature of 35°CDB/24°CWB.
 Heating: Indoor temperature of 20°CDB/15°CWB, and outdoor temperature of 7°CDB/6°CWB.
 Pipe length: 7.5 m; Height difference between outdoor unit and indoor unit: 0 m. Voltage: 230 [V].
 When AUX*018GLEH is connected to an outdoor unit other than one of the J-IVL Series, the pipe diameter should be Ø9.52/Ø15.88 mm (Liquid/Gas).
 When connecting AUXK036GLEH, AUXK045GLEH, and AUXK054GLEH to an outdoor unit other than the outdoor unit of the J-IVL Series, the gas pipe diameter should be Ø19.05 mm.

Optional parts

*For more details, please refer to the chapter "Optional parts".

- | | | |
|---------------------------------|---|--|
| Occupancy sensor Kit: UTY-SHZXC | Air Outlet Shutter Plate: UTR-YDZK | IR Receiver Unit: UTY-LBHXD |
| Wide Panel: UTG-AKXA-W | Insulation kit for high humidity: UTZ-KXRA | WLAN adapter: UTY-TFSXZ1, UTY-TFSXJ3, FG-AC-WIF1Z1 |
| Panel Spacer: UTG-BKXA-W | Cassette Grille: UTG-UKGC-W, UTG-UKGA-B | Silver Ion Filter: UTD-HFRA |
| Fresh air intake kit: UTZ-VXRA | External power supply unit: UTZ-GXXA, UTZ-GXXC* | |

Dimensions

(Unit: mm)

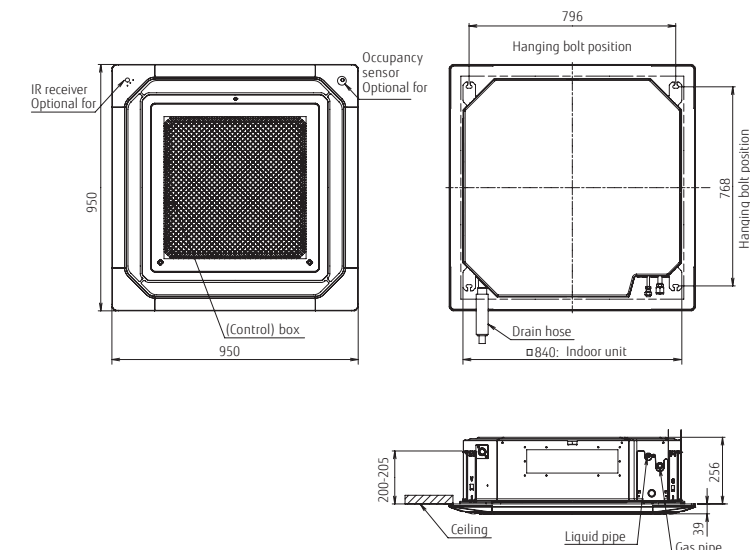

Cassette Large type Circular Flow



Unique circular flow design

This Cassette type air conditioner is equipped with a high performance DC fan motor, a turbo fan, and a louver to propel powerful airflows in all directions.

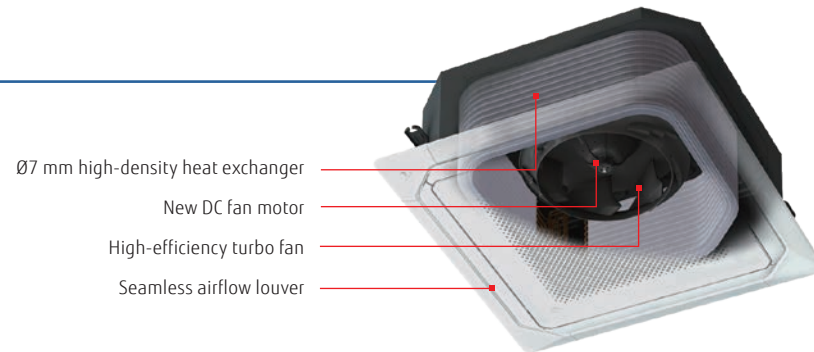

Uniform temperature air conditioning

Achieve a comfortable air conditioning spread to every corner of the room by circular flow and wide vertical airflow.

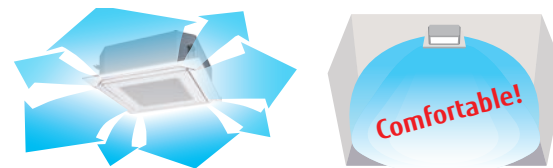

Individual louver control

Each louver can be set individually by the Touch panel wired remote controller so the user can enjoy the comfort of different directional airflows according to the room layout.

* UTY-RNRGZ5 Wired remote controller with touch panel and UTY-DCGGZ2 Central remote controller only

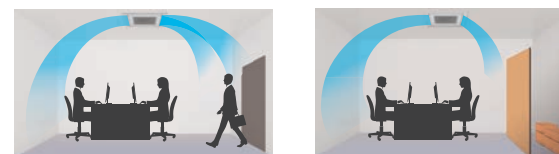

Comfortable air conditioning by preventing direct blowing of cold air and by providing swinging air flow simultaneously.

Provides efficient air conditioning based on the room layout

The Occupancy sensor contributes to further energy savings.

Energy saving operation starts automatically by detecting the motion of a person. Two modes of save operation mode and stop mode can be selected.

* UTY-RNRGZ5 Wired remote controller with touch panel and UTY-DCGGZ2 Central remote controller only



- 2 modes are available to choose from:
- Auto economy mode** The air conditioner switches to operate on reduced power when it detects that the room is unoccupied.
 - Auto-off mode** The air conditioner stops operating when it detects that the room is unoccupied.

Model: AUXK018GLEH / AUXK024GLEH / AUXK030GLEH
AUXK034GLEH / AUXK036GLEH / AUXK045GLEH
AUXK054GLEH



Specifications

Model name	AUXK018GLEH	AUXK024GLEH	AUXK030GLEH	AUXK034GLEH	AUXK036GLEH	AUXK045GLEH	AUXK054GLEH
Power source	Single phase, ~230 V, 50 Hz						
Capacity	Cooling	5.6	7.1	9.0	10.0	11.2	14.0
	Heating	6.3	8.0	10.0	11.2	12.5	16.0
Input power	kW						
Airflow rate	High	1,420	1,420	1,440	1,440	1,620	2,040
	Med-High	1,360	1,360	1,400	1,400	1,500	1,800
	Med	1,300	1,300	1,340	1,340	1,400	1,590
	Med-Low	1,270	1,270	1,300	1,300	1,340	1,440
	Low	1,200	1,200	1,280	1,280	1,280	1,300
Sound pressure level	Quiet	1,150	1,150	1,150	1,150	1,150	1,150
	High	38	38	39	39	41	44
	Med-High	37	37	38	38	40	42
	Med	36	36	37	37	38	40
	Med-Low	35	35	36	36	37	38
Dimensions (H × W × D)	mm						
	288 × 840 × 840						
Weight	kg						
Connection pipe diameter	Liquid (Flare)	6.35	9.52	9.52	9.52	9.52	9.52
	Gas (Flare)	12.70	15.88	15.88	15.88	15.88	15.88
Drain Hose Diameter (I.D./O.D.)	25/32						
Cassette Grille	Model name	UTG-UKGC-W/UTG-UKGA-B					
	Dimensions (H × W × D)	mm					
Cassette Grille	Dimensions (H × W × D)	mm					
	Weight	kg					

Note: Specifications are subject to the following conditions:
Cooling: Indoor temperature of 27°CDB/19°CWB, and outdoor temperature of 35°CDB/24°CWB.
Heating: Indoor temperature of 20°CDB/15°CWB, and outdoor temperature of 7°CDB/6°CWB.
Pipe length: 7.5 m; Height difference between outdoor unit and indoor unit: 0 m. Voltage: 230 [V].
When AUX*018GLEH is connected to an outdoor unit other than one of the J-IVL Series, the pipe diameter should be Ø9.52/Ø15.88 mm (Liquid/Gas).
When connecting AUXK036GLEH, AUXK045GLEH, and AUXK054GLEH to an outdoor unit other than the outdoor unit of the J-IVL Series, the gas pipe diameter should be Ø19.05 mm.

Optional parts

*For more details, please refer to the chapter "Optional parts".

- | | | |
|---------------------------------|---|--|
| Occupancy sensor Kit: UTY-SHZXC | Air Outlet Shutter Plate: UTR-YDZK | IR Receiver Unit: UTY-LBHXD |
| Wide Panel: UTG-AKXA-W | Insulation kit for high humidity: UTZ-KXRA | WLAN adapter: UTY-TFSXZ1, UTY-TFSXJ3, FG-AC-WIF1Z1 |
| Panel Spacer: UTG-BKXA-W | Cassette Grille: UTG-UKGC-W, UTG-UKGA-B | Silver Ion Filter: UTD-HFRA |
| Fresh air intake kit: UTZ-VXRA | External power supply unit: UTZ-GXXA, UTZ-GXXC* | |

Dimensions

(Unit: mm)

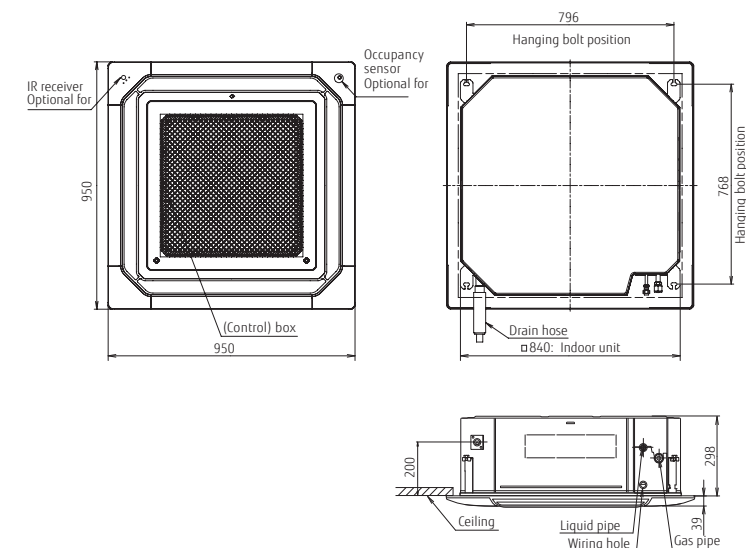

Cassette

One-way Flow type



Compact chassis size

The compact size allows easy installation in a variety of commercial facilities and environments.

- The height of the chassis is less than 200 mm for all models.
- All 4 to 12 kBTu models are less than 1,000 mm wide.
- The depth of the chassis is 570 mm, which fits nicely into a grid type ceiling.



Dimensions (Panel size)		(Unit: mm)						
		4	7	9	12	14	18	24
H			198 (43)				198 (43)	
W			785 (950)				1,190 (1,360)	
D			570 (620)				570 (620)	

Wide airflow range

A large flap with a wide range of movements, equipped with louvers arranged triangularly, sends air into every corner of the room.



In cooling mode, the left/right airflow reaches every corner of the room without directly touching the human body to provide comfortable air conditioning.

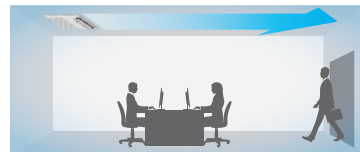

In heating mode, warm air is directed downward toward the floor to warm the feet and lower body, while the head is kept relatively cool.

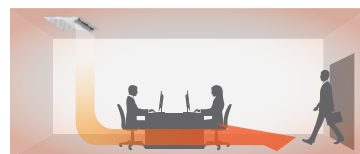

Note: This is a conceptual drawing. The performance of an air conditioner may vary depending on where it is installed, the size of the room, and its distance from the wall.

Quiet mode

The low operating noise makes the model ideal for use in hotel rooms.



Model: AUXV004GLEH / AUXV007GLEH / AUXV009GLEH
 AUXV012GLEH / AUXV014GLEH / AUXV018GLEH
 AUXV024GLEH



AUXV004/007/009/012GLEH



AUXV014/018/024GLEH

Specifications

Model name		AUXV004GLEH	AUXV007GLEH	AUXV009GLEH	AUXV012GLEH	AUXV014GLEH	AUXV018GLEH	AUXV024GLEH
Power source		Single phase, ~230 V, 50 Hz						
Capacity	Cooling	1.1	2.2	2.8	3.6	4.5	5.6	7.1
	Heating	1.3	2.8	3.2	4.0	5.0	6.3	8.0
Input power		30/30	42/42	42/42	60/60	38/38	56/56	99/99
Airflow rate*	High	460	550	550	670	720	890	1,150
	Med-High	440	440	440	520	660	840	1,020
	Med	420	420	420	480	630	770	940
	Med-Low	400	400	400	450	600	710	790
	Low	380	380	380	410	580	660	700
	Quiet	360	360	360	360	550	580	610
Sound pressure level*	High	38	42	42	45	37	44	49
	Med-High	37	37	37	41	36	43	47
	Med	36	36	36	39	35	40	45
	Med-Low	35	35	35	38	34	38	42
	Low	33	33	33	36	33	36	39
	Quiet	32	32	32	32	32	34	36
Net Dimensions (H × W × D)		mm 198 × 785 × 570	198 × 785 × 570	198 × 785 × 570	198 × 785 × 570	198 × 1,190 × 570	198 × 1,190 × 570	198 × 1,190 × 570
Weight		kg 18	19	19	19	26	26	27
Connection pipe diameter	Liquid (Flare)	mm 6.35	6.35	6.35	6.35	6.35	6.35	9.52
	Gas (Flare)	mm 9.52	9.52	9.52	12.70	12.70	12.70	15.88
Drain Hose Diameter (I.D./O.D.)					25/32			
Cassette Grille	Model name	UTG-UNGA-W			UTG-UNGB-W			
	Net Dimensions (H × W × D)	mm 43 × 950 × 620			43 × 1,360 × 620			
	Weight	kg 6.5			8.5			

Note: Specifications are subject to the following conditions:
 Cooling: Indoor temperature of 27°CDB/19°CWB, and outdoor temperature of 35°CDB/24°CWB.
 Heating: Indoor temperature of 20°CDB/15°CWB, and outdoor temperature of 7°CDB/6°CWB.
 Pipe length: 7.5 m; Height difference between outdoor unit and indoor unit: 0 m. Voltage: 230 [V]

Optional parts

*For more details, please refer to the chapter "Optional parts".

- WLAN adapter: UTY-TFSXZ1, UTY-TFSXJ3, FG-AC-WIF1Z1
- IR Receiver Unit: UTY-TRHX
- Cassette Grille: UTG-UNGA-W/UTG-UNGB-W
- External power supply unit: UTZ-GXXA, UTZ-GXXC*

Flexible Installation

The L-shaped pipe kit allows for more flexible installation. Equipped with a built-in drain pump as standard, which enables a maximum pipe height difference of 700 m from the ceiling.

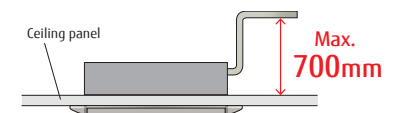

Dimensions

(Unit: mm)

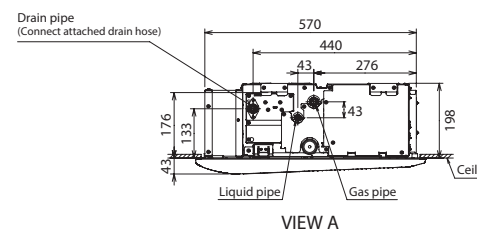
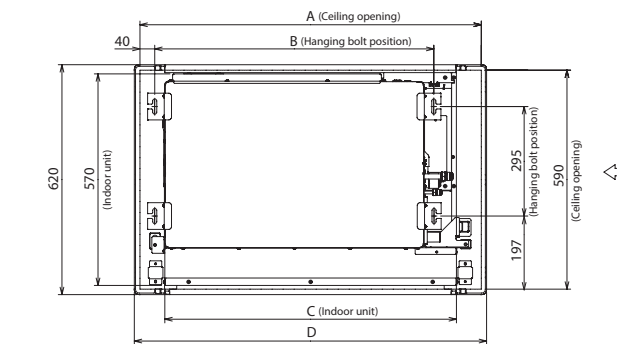

	AUXV004-012	AUXV014-024
A	920	1,330
B	752	1,152
C	785	1,190
D	950	1,360

3D Flow Cassette



3 individually controlled air outlet ports

The Comfortable airflow setting enables the left and right air outlet ports as well as the wide center port to work together to provide a comfortable room environment.

Temperature distribution during cooling and heating (when set to Comfortable airflow)

Testing conditions: Model AUXS024GLEH running cooling operation with the air volume set to "Hi" to maintain the room temperature at 18°C with the outdoor temperature at 35°C, tested in our 40m² environmental test room

Testing conditions: Model AUXS024GLEH running heating operation with the air volume set to "Hi" to maintain the room temperature at 30°C with the outdoor temperature at 7°C, tested in our 40m² environmental test room

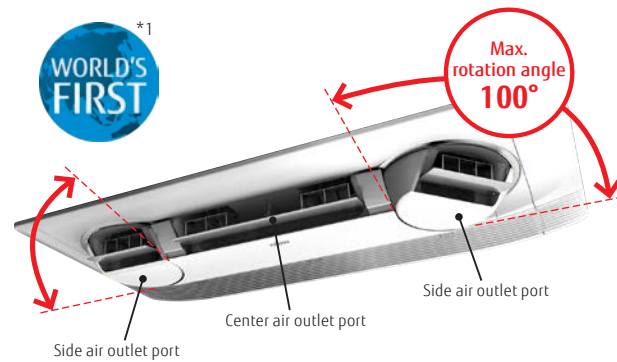

*1: Announced 2018. In the category of room air conditioners for the home (source: Fujitsu General Limited).

Individual airflow setting

The individual airflow setting function optimizes the airflow direction to match the room layout.

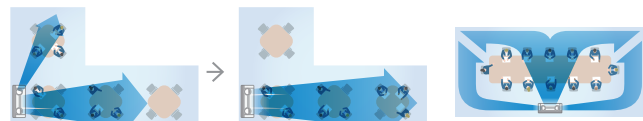

Adjusts airflows from the side air outlet ports to match the layout and usage of the room to minimize the amount of wasted airflow.

The airflow is optimally controlled to provide improved comfort in a narrow room.

Individual control of air outlet ports

Individual airflow can be set using a Wired remote controller with touch panel and Central remote controller*. The airflow from each air outlet port can be set individually.

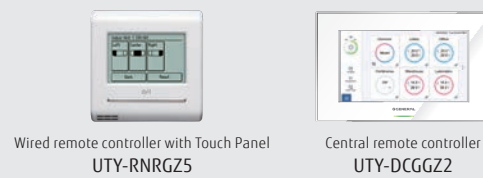

* Feature available only on UTY-RNRGZ5 Wired remote controller with touch panel and UTY-DCGGZ2 Central remote controller

High energy saving

The structural design to take in a larger volume of air and blow air out more smoothly reduces air blowing loss and achieves class-leading energy-saving performance.

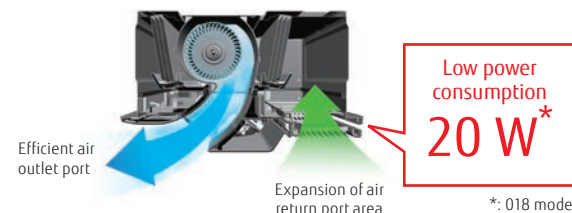

*: 018 model

Model: AUXS018GLEH / AUXS024GLEH



Specifications

Model name		AUXS018GLEH		AUXS024GLEH	
Power source		Single phase, ~230 V, 50 Hz			
Capacity	Cooling	5.60		7.10	
	Heating	6.30		8.00	
Input power		20/28		34/43	
Airflow rate*	High	750/870		950/1,040	
	Med-High	710/830		890/990	
	Med	690/780		860/930	
	Med-Low	660/740		810/880	
	Low	630/700		770/840	
	Quiet	540/540		540/540	
Sound pressure level*	High	38/41		43/46	
	Med-High	36/40		42/45	
	Med	35/39		41/43	
	Med-Low	35/37		40/42	
	Low	33/36		38/40	
	Quiet	29/29		29/29	
Net Dimensions (H × W × D)		mm 200 × 1,240 × 500		mm 200 × 1,240 × 500	
Weight		kg 25		kg 25	
Connection pipe diameter	Liquid (Flare)	6.35		9.52	
	Gas (Flare)	12.70		15.88	
Drain Hose Diameter (I.D./O.D.)				25/32	
Cassette Grille	Model name			UTG-USGA-W	
	Net Dimensions (H × W × D)	mm		85 × 1,350 × 580	
Weight		kg		11.5	

Note: Specifications are subject to the following conditions:
 Cooling: Indoor temperature of 27°CDB/19°CWB, and outdoor temperature of 35°CDB/24°CWB.
 Heating: Indoor temperature of 20°CDB/15°CWB, and outdoor temperature of 7°CDB/6°CWB.
 Pipe length: 7.5 m; Height difference between outdoor unit and indoor unit: 0 m. Voltage: 230 [V]
 *: Applicable to cooling and heating operation

Optional parts

- WLAN adapter: UTY-TFSXZ1, UTY-TFSXJ3, FG-AC-WIF1Z1
- IR Receiver Unit: UTY-TRHX
- Cassette Grille: UTG-USGA-W
- External power supply unit: UTZ-GXXA, UTZ-GXXC*

Dimensions

(Unit: mm)

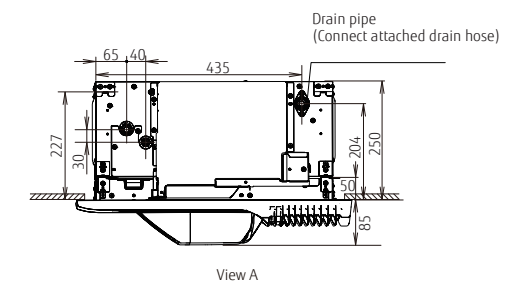
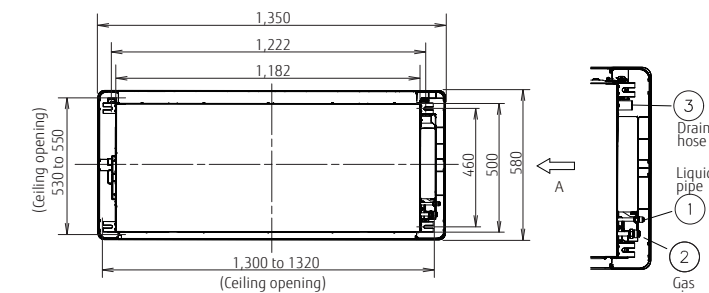

Low Static Pressure Duct Mini Duct (With drain pump)



Space saving design

- Fits into a space 198 mm high and 450 mm deep
- 30% smaller than previous-generation models
- Weighs 16 kg, 10% lighter

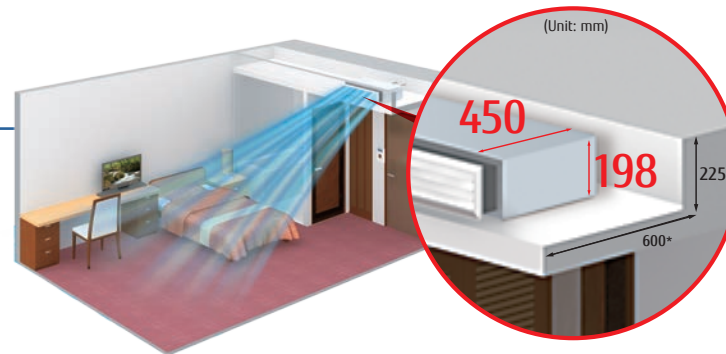

*: Minimum clearance requirement

Optimum airflow path and low noise operation

The stabilized airflow reduces the noise level significantly.

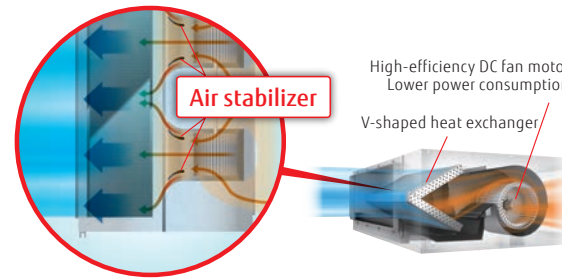

6-speed control*

Multistep airflow adjustment allows installation in a quiet location.

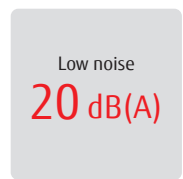

at 04 model

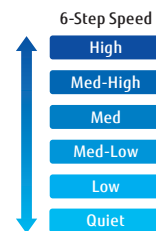

* Remote controller is compatible with the following:
UTY-RNRGZ5/UTY-RLRG/UTY-PSRG/UTY-RHRG/UTY-DCGGZ2/UTY-ALGXZ1/UTY-APQXZ1

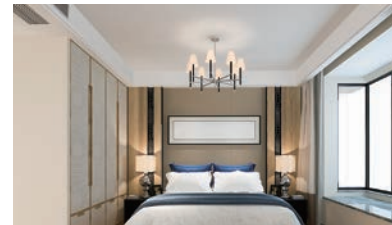

Easy to design and maintain for drain

Indoor unit design for easy maintenance. Parts can be replaced from the side of the unit where maintenance is easier.

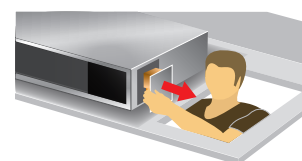

A drain pump is built into the unit as standard. Parts can be accessed and replaced through the side of the unit for easy maintenance.

Model: ARXK004GLGH / ARXK007GLGH / ARXK009GLGH
ARXK012GLGH / ARXK014GLGH / ARXK018GLGH
ARXK024GLGH

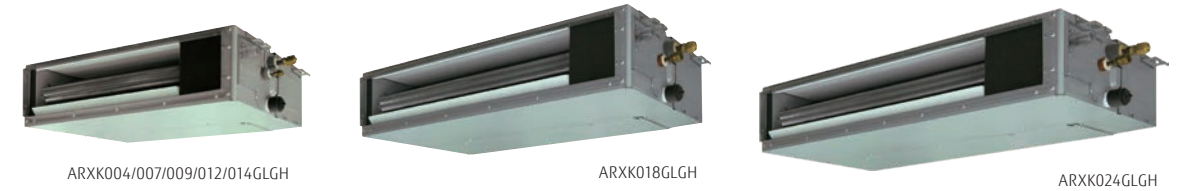

Specifications

Model name	ARXK004GLGH	ARXK007GLGH	ARXK009GLGH	ARXK012GLGH	ARXK014GLGH	ARXK018GLGH	ARXK024GLGH
Power source	Single phase, ~230 V, 50 Hz						
Capacity	Cooling	1.1	2.2	2.8	3.6	4.5	7.1
	Heating	1.3	2.8	3.2	4.0	5.0	8.0
Input power	W	26	28	28	35	66	80
Airflow rate	High	460	460	460	550	760	1,160
	Med-High	440	440	440	520	660	1,060
	Med	420	420	420	480	560	960
	Med-Low	400	400	400	450	490	860
	Low	370	370	370	410	410	540
Quiet	340	340	340	340	340	470	610
Static pressure range	Pa	0 to 30	0 to 30	0 to 30	0 to 30	0 to 50	0 to 50
Standard static pressure		10	10	10	10	15	15
Sound pressure level	High	25	26	26	29	34	32
	Med-High	24	25	25	27	31	30
	Med	23	24	24	26	28	28
	Med-Low	22	23	23	25	26	27
	Low	21	22	22	24	24	25
Quiet	20	21	21	22	22	22	
Net Dimensions (H × W × D)	mm	198 × 700 × 450	198 × 700 × 450	198 × 700 × 450	198 × 700 × 450	198 × 700 × 450	198 × 900 × 450
Weight	kg	14.5	15.5	15.5	16	16	19
Connection pipe diameter	Liquid (Flare)	6.35	6.35	6.35	6.35	6.35	9.52
	Gas (Flare)	9.52	9.52	9.52	12.70	12.70	15.88
Drain Hose Diameter (I.D./O.D.)				25/32			

Note: Specifications are subject to the following conditions:
Cooling: Indoor temperature of 27°CDB/19°CWB, and outdoor temperature of 35°CDB/24°CWB.
Heating: Indoor temperature of 20°CDB/15°CWB, and outdoor temperature of 7°CDB/6°CWB.
Pipe length: 7.5 m; Height difference between outdoor unit and indoor unit: 0 m. Voltage: 230 [V].

Optional parts

*For more details, please refer to the chapter "Optional parts".

Remote sensor unit:	UTY-XSZXZ1	External power supply unit:	UTZ-GXXA, UTZ-GXXC*
IR receiver unit:	UTY-TRHX	Auto Louver Grille Kit:	UTD-GXTA-W (004-014) UTD-GXTB-W (018) UTD-GXTC-W (024)
Silver Ion Filter:	UTD-HFTA (004-014) UTD-HFTB (018) UTD-HFTC (024)	WLAN adapter:	FG-AC-WIF1Z1 UTY-TFSXJ3, UTY-TFSXZ1 (007-024)

Auto Louver Grille Kit (Optional)

The slim design of the unit provides comfortable cooling and heating air conditioning over a wide area. The optional automatic louver grille, which fits nicely into any interior decor, provides comfortable air conditioning (Optional)



Dimensions

(Unit: mm)

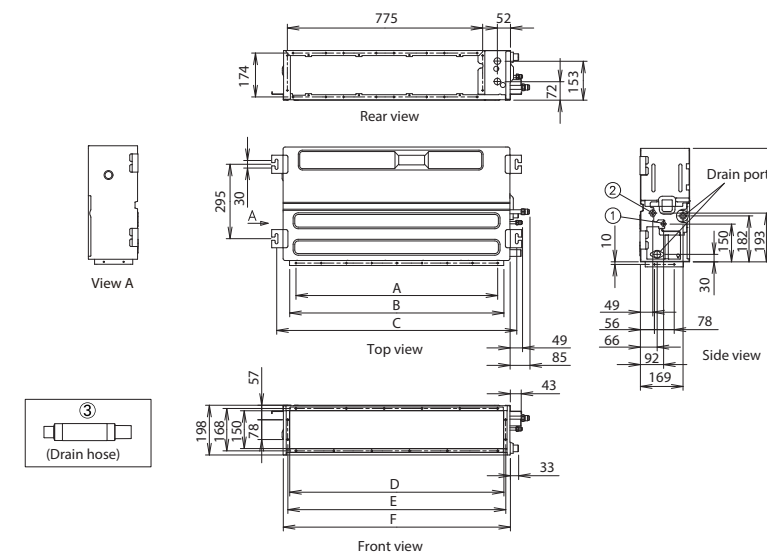

- ① Refrigerant pipe flare connection (Liquid)
- ② Refrigerant pipe flare connection (Gas)
- ③ Drain hose connection

	ARXK004-014	ARXK018	ARXK024
A	P100×6=600	P100×8=800	P100×10=1000
B	650	850	1050
C	752	952	1152
D	650	850	1050
E	665	864	1064
F	700	900	1100

Low Static Pressure Duct Slim Duct/Slim Concealed Floor



Slim design

Slim design allows for installation in a tight ceiling space.

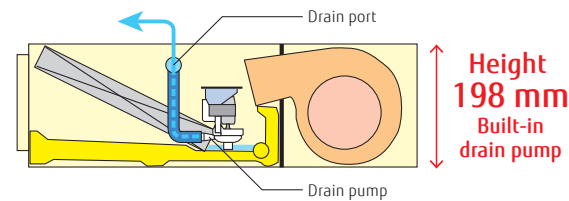

Air intake

Air intake direction can be selected to match the installation site.

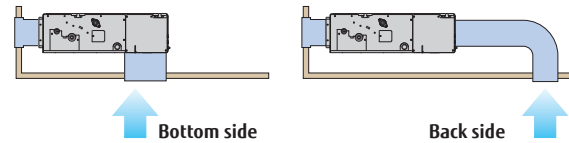

Flexible installation

Ceiling concealed

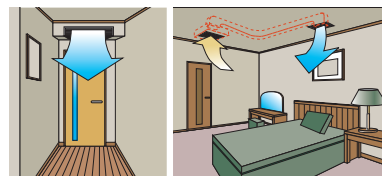

Floor concealed

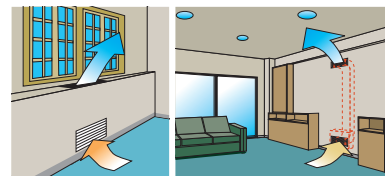

Wide range of static pressures

The use of a DC fan motor makes it possible to adjust the static pressure between 0 and 90 Pa. The static pressure range can be changed by a remote controller.



Static pressure range
0 to 90 Pa

*024 model static pressure range is 0 to 50 Pa.

Filter (Accessory)

ARXD04/007/009/012/014/018 ARXD024

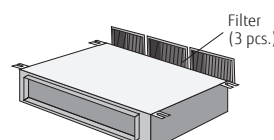
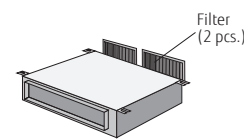

Model: ARXD04GALH / ARXD007GLEH / ARXD009GLEH
ARXD012GLEH / ARXD014GLEH / ARXD018GLEH
ARXD024GLEH

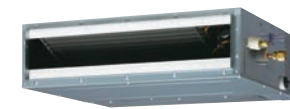

ARXD04GALH
ARXD007/009/012/014GLEH

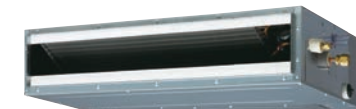

ARXD018GLEH



ARXD024GLEH

Slim Concealed Floor



Specifications

Model name	ARXD04GALH*	ARXD007GLEH	ARXD009GLEH	ARXD012GLEH	ARXD014GLEH	ARXD018GLEH	ARXD024GLEH
Power source	Single phase, ~230 V, 50 Hz						
Capacity	Cooling	1.1	2.2	2.8	3.6	4.5	7.1
	Heating	1.3	2.8	3.2	4.0	5.0	8.0
Input power	W	40	44	50	54	92	122
Airflow rate	High	510	550	600	600	800	1,330
	Med-High	-	480	510	530	680	1,140
	Med	400/470*1	440	460	490	600	730
	Med-Low	-	410	420	450	520	630
	Low	320/440*1	370	370	410	440	540
Quiet	-	320	320	340	340	470	610
Static pressure range	Pa	0 to 90	0 to 90	0 to 90	0 to 90	0 to 90	0 to 50
Standard static pressure	High	26	28	29	30	34	35
	Med-High	-	26	27	28	32	31
Sound pressure level	Med	21/25*1	25	25	27	30	29
	Med-Low	-	24	24	26	28	27
	Low	20/22*1	22	22	24	25	24
	Quiet	-	21	21	22	22	23
	Quiet	-	21	21	22	22	23
Net Dimensions (H × W × D)	mm	198 × 700 × 620	198 × 700 × 620	198 × 700 × 620	198 × 700 × 620	198 × 700 × 620	198 × 900 × 620
Weight	kg	17	17	17	18	18	26
Connection pipe diameter	Liquid (Flare)	6.35	6.35	6.35	6.35	6.35	9.52
	Gas (Flare)	12.70	9.52	9.52	12.70	12.70	15.88
Drain Hose Diameter (I.D./O.D.)				25/32			

Note: Specifications are subject to the following conditions:

Cooling: Indoor temperature of 27°CDB/19°CWB, and outdoor temperature of 35°CDB/24°CWB.

Heating: Indoor temperature of 20°CDB/15°CWB, and outdoor temperature of 7°CDB/6°CWB.

Pipe length: 7.5 m; Height difference between outdoor unit and indoor unit: 0 m. Voltage: 230 [V].

*1: This value is under cooling operation.

*: ARXD04GALH cannot be connected to J-IVS/J-IVJ-IVL/VR-IV Series.

Optional parts

*For more details, please refer to the chapter "Optional parts".

Remote sensor unit: UTY-XSZX21

External power supply unit: UTZ-GXXA, UTZ-GXXC*

IR receiver unit: UTB-YWC (04)

Auto Louver Grille Kit: UTD-GXTA-W (04, 007-014)

UTY-TRHX (007-024)

UTD-GXTB-W (018)

UTY-TFSXJ3 (007-024)

UTD-GXTC-W (024)

UTY-TFSXZ1 (007-024)

Silver Ion Filter: UTD-HFTA (04, 007-014)

FG-RC-WIF122 (04)

UTD-HFTB (018)

FG-AC-WIF121 (007-024)

UTD-HFTC (024)

Drain hose provided as an accessory.

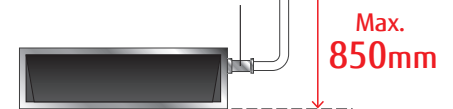

Dimensions

(Unit: mm)

*Maintenance accessibility should be considered when installing the product. Refer to the installation manual for the required maintenance access size.

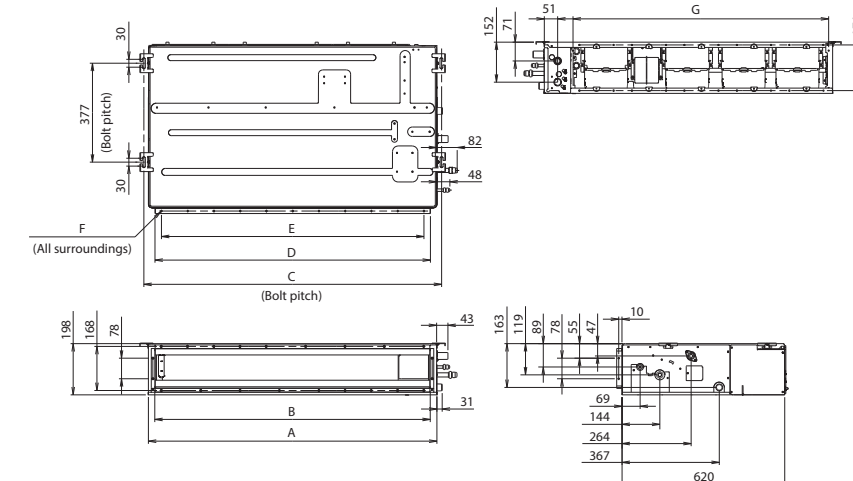

	ARXD04-014	ARXD018	ARXD024
A	700	900	1100
B	650	850	1050
C	734	934	1134
D	650	850	1050
E	P100 × 6 = 600	P100 × 8 = 800	P100 × 10 = 1000
F	18 × Ø5	22 × Ø5	26 × Ø5
G	574	774	974

Low static pressure duct High Efficiency



Slim & Compact design

The slim and compact design of the indoor unit, with the control box mounted on the side, allows installation in narrow spaces.

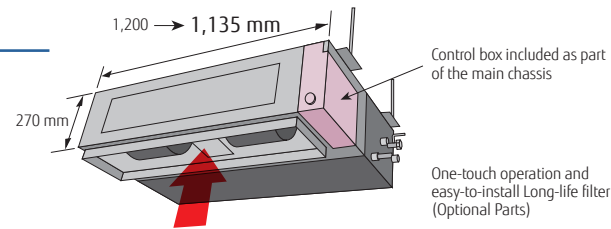

Easy maintenance

Structural improvement has been developed by making the bottom panel in two pieces, front and rear. The internal fan casing is also manufactured in two pieces—upper and lower. The motor and fan can be easily accessed and maintained by removing the rear panel and the lower casing with the main chassis remaining in place.

See below for rear-suction type

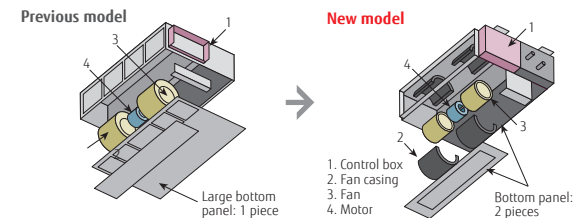

Installation styles

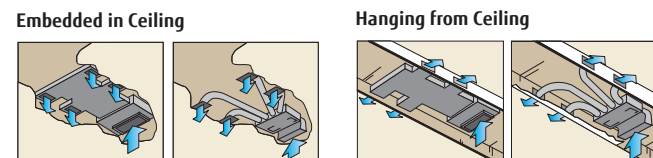

A drain pipe can be installed on either the left or right side of the unit

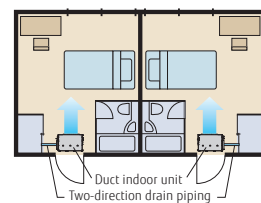

High-efficiency DC fan motor achieves low-energy consumption.

Improved motor efficiency from previous model.

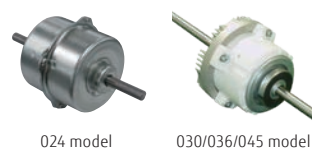

Wide range of static pressures

Static pressures can be changed in the range of 0 to 150 Pa.

Static pressure range
0 to 80 Pa

Model: ARXP018GLFH / ARXP030GLFH * Production by order



Specifications

Model name		ARXP018GLFH	ARXP030GLFH
Power source		Single-phase, ~220V, 50Hz	
Capacity	Cooling	5.6	9.0
	Heating	6.3	10.0
Input power		128	228
Airflow rate	High	1,540 / 1,440	1,940 / 1,660
	Med-High	1,460 / 1,380	1,810 / 1,580
	Med	1,380 / 1,320	1,680 / 1,510
	Med-Low	1,300 / 1,260	1,550 / 1,440
	Low	1,220 / 1,200	1,420 / 1,370
Quiet		1,150 / 1,150	1,300 / 1,300
Static pressure range		0 to 80	0 to 80
Standard static pressure		40	50
Sound pressure level	High	35 / 34	39 / 36
	Med-High	34 / 32	38 / 35
	Med	32 / 31	36 / 34
	Med-Low	31 / 30	34 / 33
	Low	29 / 29	32 / 31
Quiet		28 / 28	30 / 30
Net Dimensions (H × W × D)		270 × 1,135 × 700	270 × 1,135 × 700
Weight		40	40
Connection pipe diameter	Liquid (Flare)	6.35	9.52
	Gas (Flare)	12.70	15.88
Drain Hose Diameter (I.D./O.D.)		25/32	

Note: Specifications are subject to the following conditions:
Cooling: Indoor temperature of 27°CDB/19°CWB, and outdoor temperature of 35°CDB/24°CWB.
Heating: Indoor temperature of 20°CDB/15°CWB, and outdoor temperature of 7°CDB/6°CWB.
Pipe length: 7.5 m; Height difference between outdoor unit and indoor unit: 0 m. Voltage: 230 [V].

Optional parts

*For more details, please refer to the chapter "Optional parts."

- Long-life filter: UTD-LF25NA
- Flange (square): UTD-SF045T
- Flange (round): UTD-RF204
- External power supply unit: UTZ-GXXA, UTZ-GXXC*
- Remote sensor unit: UTY-XSZXZ1
- IR receiver unit: UTY-TRHX
- Drain pump unit: UTZ-PX1NBA
- WLAN adapter: UTY-TFSXZ1, UTY-TFSXJ3, FG-AC-WIF1Z1
- Silver Ion Filter: UTD-HFND

Dimensions

(Unit: mm)

*Maintenance accessibility should be considered when installing the product. Refer to the installation manual for the required maintenance access size.

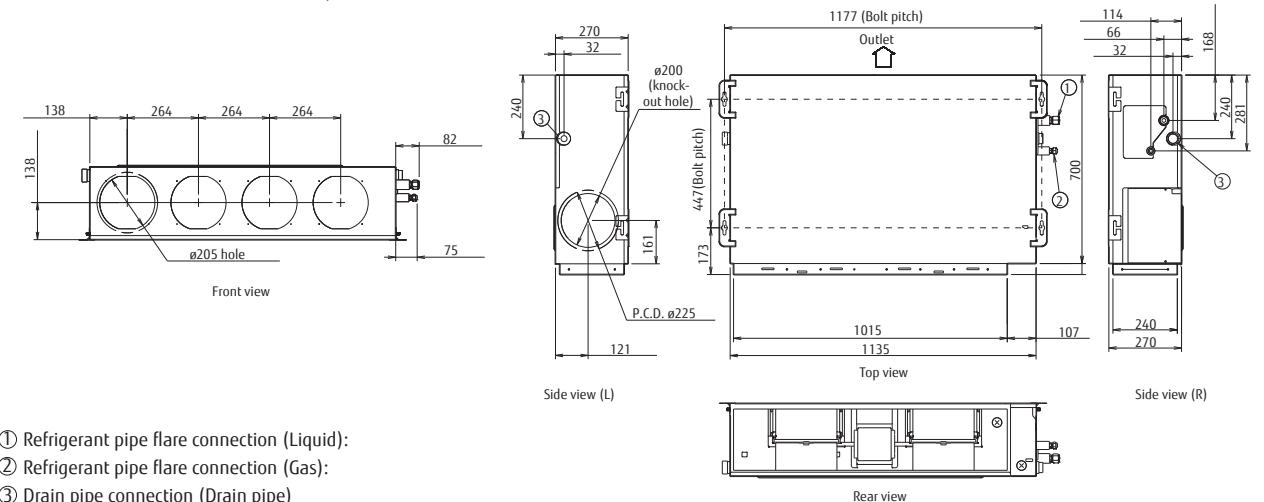

- ① Refrigerant pipe flare connection (Liquid):
- ② Refrigerant pipe flare connection (Gas):
- ③ Drain pipe connection (Drain pipe)

Medium static pressure duct Normal



Slim & Compact design

The slim and compact design of the indoor unit, with the control box mounted on the side, allows installation in narrow spaces.

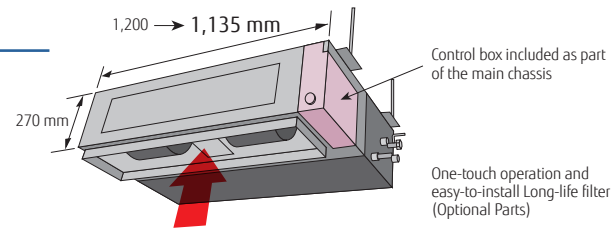

Easy maintenance

Structural improvement has been developed by making the bottom panel in two pieces, front and rear. The internal fan casing is also manufactured in two pieces—upper and lower. The motor and fan can be easily accessed and maintained by removing the rear panel and the lower casing with the main chassis remaining in place.

See below for rear-suction type

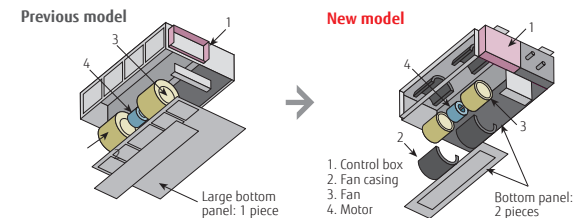

Installation styles

Embedded in Ceiling

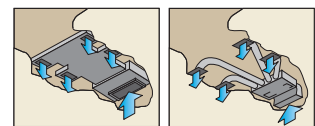

Hanging from Ceiling

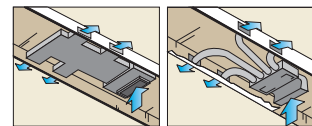

A drain pipe can be installed on either the left or right side of the unit

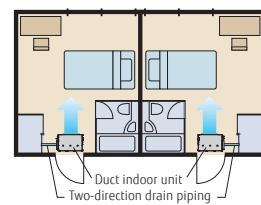

High-efficiency DC fan motor achieves low-energy consumption.

Improved motor efficiency from previous model.

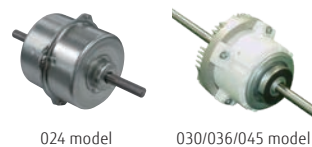

Wide range of static pressures

Static pressures can be changed in the range of 0 to 150 Pa.

Static pressure range
0 to 150 Pa

Model: ARXA024GLEH / ARXA030GLEH / ARXA036GLEH / ARXA045GLEH

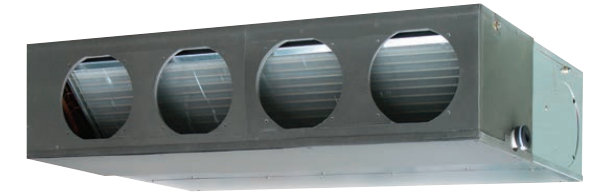

Specifications

Model name			ARXA024GLEH	ARXA030GLEH	ARXA036GLEH	ARXA045GLEH
Power source			Single phase, ~230 V, 50 Hz			
Capacity	Cooling	kW	7.1	9.0	11.2	12.5
	Heating	kW	8.0	10.0	12.5	14.0
Input power	W		94	108	194	240
Airflow rate	High	m ³ /h	1,280	1,410	1,840	1,970
	Med-High		1,180	1,350	1,750	1,910
	Med		1,090	1,280	1,660	1,860
	Med-Low		1,000	1,240	1,600	1,780
	Low		920	1,190	1,530	1,710
Quiet	840	1,150	1,470	1,640		
Static pressure range	Pa		0 to 150	0 to 150	0 to 150	0 to 150
Standard static pressure			40	50	50	60
Sound pressure level	High	dB(A)	31	34	37	41
	Med-High		29	33	36	40
	Med		27	32	35	38
	Med-Low		26	31	35	38
	Low		24	30	34	37
Quiet	23	29	33	36		
Net Dimensions (H × W × D)	mm		270 × 1,135 × 700	270 × 1,135 × 700	270 × 1,135 × 700	270 × 1,135 × 700
Weight	kg		36	40	40	40
Connection pipe diameter	Liquid (Flare)	mm	9.52	9.52	9.52	9.52
	Gas (Flare)		15.88	15.88	15.88	15.88
Drain Hose Diameter (I.D./O.D.)			25/32			

Note: Specifications are subject to the following conditions:

Cooling: Indoor temperature of 27°CDB/19°CWB, and outdoor temperature of 35°CDB/24°CWB.
Heating: Indoor temperature of 20°CDB/15°CWB, and outdoor temperature of 7°CDB/6°CWB.
Pipe length: 7.5 m; Height difference between outdoor unit and indoor unit: 0 m. Voltage: 230 [V].

Optional parts

*For more details, please refer to the chapter "Optional parts".

Long-life filter:	UTD-LF25NA	IR receiver unit:	UTY-TRHX
Flange (square):	UTD-SF045T	Drain pump unit:	UTZ-PX1NBA
Flange (round):	UTD-RF204	WLAN adapter:	UTY-TFSXZ1, UTY-TFSXJ3, FG-AC-WIF1Z1
External power supply unit:	UTZ-GXXA, UTZ-GXXC*	Silver Ion Filter:	UTD-HFND
Remote sensor unit:	UTY-XSZXZ1		

Dimensions

(Unit: mm)

*Maintenance accessibility should be considered when installing the product. Refer to the installation manual for the required maintenance access size.

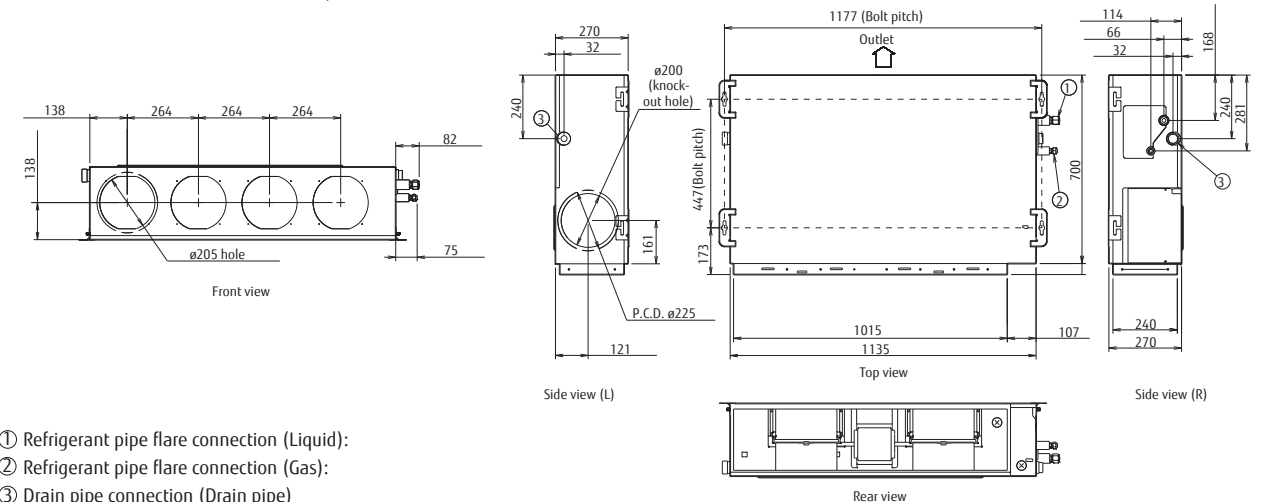

- ① Refrigerant pipe flare connection (Liquid):
- ② Refrigerant pipe flare connection (Gas):
- ③ Drain pipe connection (Drain pipe)

High Static Pressure Duct Normal



Model: ARXC036GTEH / ARXC045GTEH / ARXC060GTEH
ARXC072GTEH / ARXC090GTEH / ARXC096GTEH



ARXC036/045/060GTEH



ARXC072/090GTEH



ARXC096GTEH

Static pressure mode selection

The use of a DC fan motor makes it possible to adjust the static pressure between 0 to 200 Pa (ARXC036) / 250Pa (ARXC045/060) / 300 Pa (ARXC072/090/096)

MAX. 200 Pa (036 type)



(ARXC036/045/060 type)

MAX. 250 Pa (045/060 type)



(ARXC072/090 type)

MAX. 300 Pa



(ARXC096 type)

MAX. 300 Pa

Easy installation (Compact & Lightweight)

The indoor unit is designed to be compact and light by reducing the basic chassis size and the overall material weight.

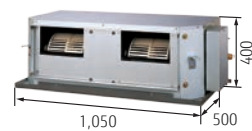

(ARXC036/045/060 type)

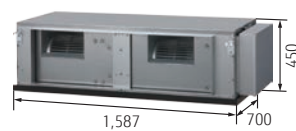

(ARXC072/090 type)

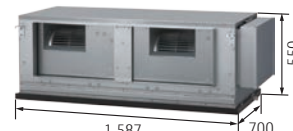

(ARXC096 type)

(Unit: mm)

Low noise

Models: ARXC036/ARXC045/ARXC060

The corners of the front panel and fan casing of the indoor unit are shaved to reduce air turbulence. The use of a plastic case and fan reduces the noise level generated by the unit.

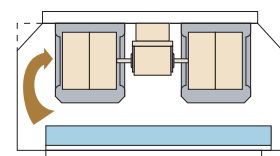

ARXC036GTEH: Plastic fan [42 dB(A)]

* Model: Material (Actual noise measurement value measured at 100 Pa)

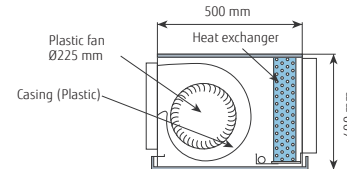

High-efficiency DC fan motor achieves low energy consumption.

Improved motor efficiency compared to the previous model



(ARXC036/045/060 type)



(ARXC072/090/096 type)

Specifications

Model name	ARXC036GTEH	ARXC045GTEH	ARXC060GTEH*	ARXC072GTEH*	ARXC090GTEH*	ARXC096GTEH*
Power source	Single phase, ~230 V, 50 Hz					
Capacity	Cooling	11.2	12.5	18.0	22.4	28.0
	Heating	12.5	14.0	20.0	25.0	31.5
Input power		207	715	730	681	838
		1,990	3,500	3,500	3,900	4,300
Airflow rate	High	1,990	3,500	3,500	3,900	4,300
	Med	1,680	3,000	3,000	3,300	4,000
	Low	1,330	2,460	2,460	3,000	3,500
Static pressure range	Pa					
Standard static pressure	0 to 200	100 to 250	100 to 250	0 to 300	0 to 300	0 to 300
Sound pressure level	High	42	49	49	47	48
	Med	36	45	45	43	46
	Low	32	42	42	40	44
Net Dimensions (H × W × D)	mm 400 × 1,050 × 500	400 × 1,050 × 500	400 × 1,050 × 500	450 × 1,587 × 700	450 × 1,587 × 700	550 × 1,587 × 700
Weight	kg 40	46	46	84	84	105
Connection pipe diameter	Liquid	9.52 (Flare)	9.52 (Flare)	9.52 (Flare)	9.52 (Flare)	9.52 (Brazing)
	Gas	15.88 (Flare)	15.88 (Flare)	15.88 (Flare)	19.05 (Flare)	19.05 (Flare)
Drain Hose Diameter (I.D./O.D.)	25/32					

Note: Specifications are based on the following conditions:
Cooling: Indoor temperature of 27°CDB/19°CWB, and outdoor temperature of 35°CDB/24°CWB.
Heating: Indoor temperature of 20°CDB/15°CWB, and outdoor temperature of 7°CDB/6°CWB.
Pipe length: 7.5 m; Height difference between outdoor unit and indoor unit: 0 m. Voltage: 230 [V]
*: ARXC060/072/090/096G cannot be connected to J-IVJ-IVS Series.

Optional parts

- Long-life filter: UTD-LF60KA (036/045/060)
- IR receiver unit: UTY-TRHX
- External power supply unit: UTZ-GXXA, UTZ-GXXC*
- WLAN adapter: UTY-TFSXZ1, UTY-TFSXJ3, FG-AC-WIF1Z1
- Silver Ion Filter: UTD-HFKB (036/045/060)
- Remote sensor unit: UTY-XSZXZ1

Dimensions

(Unit: mm)

Models: ARXC036/ARXC045/ARXC060

Models: ARXC072/ARXC090

Models: ARXC096

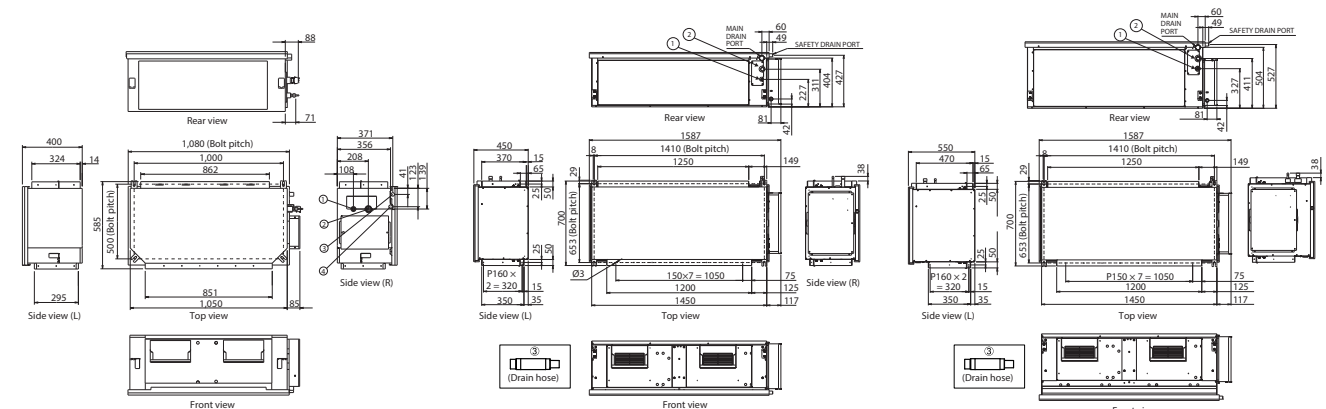

- ① Refrigerant pipe flare connection (Liquid)
- ② Refrigerant pipe flare connection (Gas)
- ③ Drain pipe connection (Safety drain pan)
- ④ Drain pipe connection (Main drain pan)

- ① Refrigerant pipe flare connection (Liquid)
- ② Refrigerant pipe flare connection (Gas)
- ③ Drain hose

- ① Refrigerant pipe flare connection (Liquid)
- ② Refrigerant pipe flare connection (Gas)
- ③ Drain hose

Compact floor



Model: AGHA004GCGH / AGHA007GCGH / AGHA009GCGH
 AGHA012GCGH / AGHA014GCGH
 [external EEV]
 AGHE004GCEH / AGHE007GCEH / AGHE009GCEH
 AGHE012GCEH / AGHE014GCEH



Specifications

Model name		AGHA004GCGH	AGHA007GCGH	AGHA009GCGH	AGHA012GCGH	AGHA014GCGH	AGHE004GCEH	AGHE007GCEH	AGHE009GCEH	AGHE012GCEH	AGHE014GCEH	
Power source		Single phase, ~230 V, 50 Hz						Single phase, ~230 V, 50 Hz				
Capacity	Cooling	1.1	2.2	2.8	3.6	4.0	1.1	2.2	2.8	3.6	4.0	
	Heating	1.3	2.8	3.2	4.0	4.5	1.3	2.8	3.2	4.0	4.5	
Input power		12/14		16	17	22	14	16	17	22	29	
Airflow rate	High	380/430	470	500	590	670	380/430	470	500	590	670	
	Med-High	350	420	450	520	590	350	420	450	520	590	
	Med	320	390	400	470	520	320	390	400	470	520	
	Med-Low	310	360	360	420	450	310	360	360	420	450	
	Low	280	330	330	390	390	280	330	330	390	390	
Sound pressure level	High	35/36	37	38	42	46	35/36	37	38	42	46	
	Med-High	33	35	36	39	42	33	35	36	39	42	
	Med	31	33	34	37	39	31	33	34	37	39	
	Med-Low	30	31	31	35	36	30	31	31	35	36	
	Low	28	29	29	33	33	28	29	29	33	33	
Quiet	22	22	22	30	30	22	22	22	30	30		
Net Dimensions (H × W × D)		600 × 740 × 200						600 × 740 × 200				
Weight		15.0	15.0	15.0	15.0	15.0	14.5	14.5	14.5	14.5	14.5	
Connection pipe diameter	Liquid (Flare)	6.35	6.35	6.35	6.35	6.35	6.35	6.35	6.35	6.35	6.35	
	Gas (Flare)	9.52	9.52	9.52	12.70	12.70	9.52	9.52	9.52	12.70	12.70	
Drain Hose Diameter (I.D./O.D.)		13.8/15.8 to 16.7						13.8/15.8 to 16.7				
EV kit (optional)								UTR-EV09XB		UTR-EV14XB		

2-fan and wide airflow

A 2-fan individual vertical airflow cools or warms the entire room comfortably.

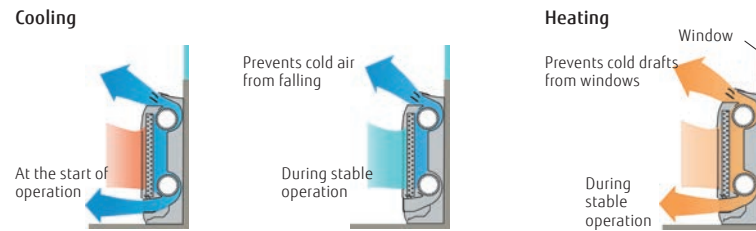

Flexible and easy installation

The compact and whole-surface suction design provides flexible installation options, including floor-standing, embedded, partially embedded, and wall-mounted installation to match the room layout.

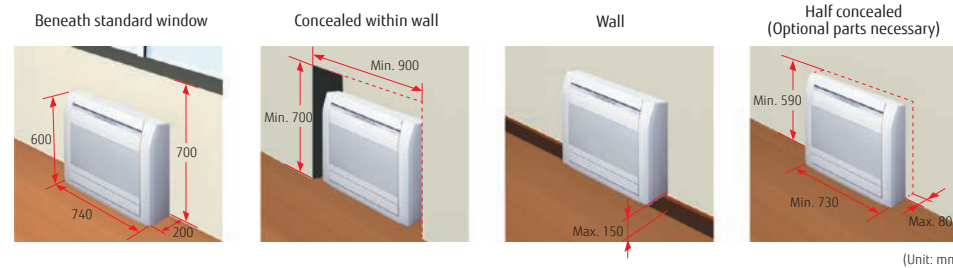

Quiet operation

6-fan speed control for quiet operation (via 2-wire controller)

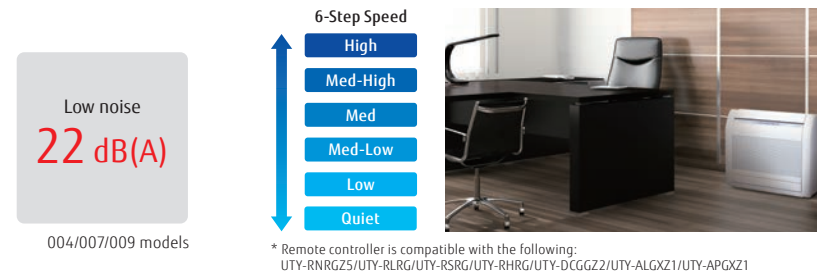

Flexible pipe connection enables draining and piping in 6 directions

The drain hose and pipe can be connected to the unit in the right, left, straight in depth, or downward direction.

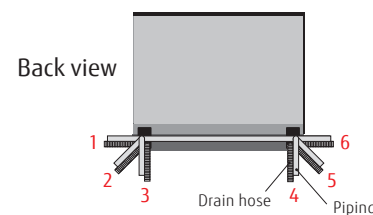

Optional parts

- Partially concealing kit: UTR-STA
- External power supply unit: UTZ-GXXA, UTZ-GXXC*
- WLAN adapter: UTY-TFSXZ1, UTY-TFSXJ3, FG-AC-WIF1Z1
- Silver Ion Filter: UTR-FA03-5

Dimensions

(Unit: mm)

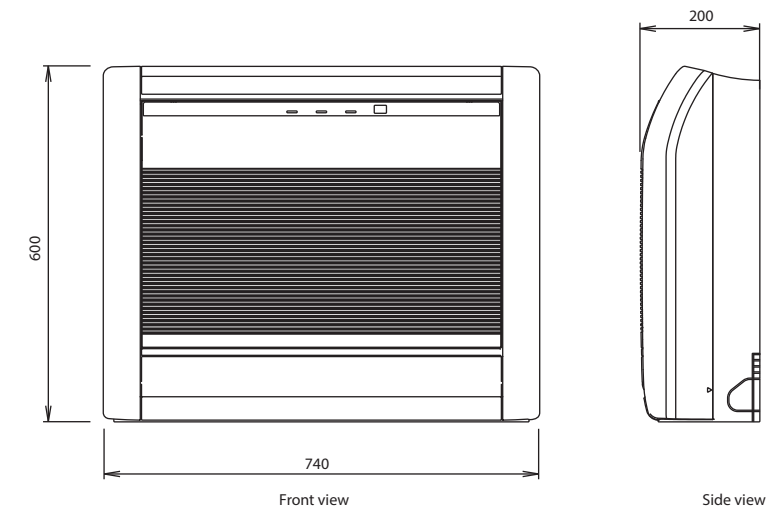

Floor/Ceiling



Flexible installation

Example of floor standing installation

Floor standing console with the back against the wall



Example of ceiling installation

Under ceiling



Double auto swing

The combination of horizontal and vertical swings enables 3-dimensional control of the airflow direction.

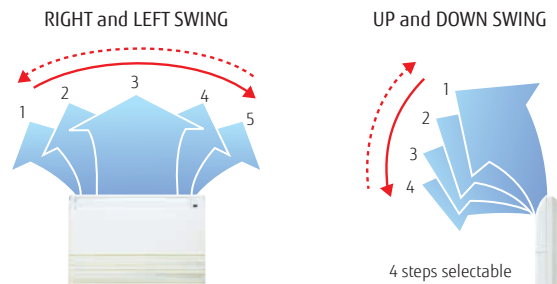

High-power DC fan motor

- High power
- Wide rotation range
- High-efficiency



Compact design

Symmetrical, slim and compact design.

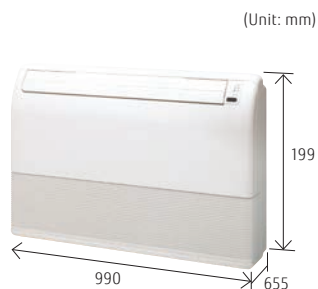

Model: ABHA012GTEH / ABHA014GTEH / ABHA018GTEH / ABHA024GTEH



Specifications

Model name		ABHA012GTEH	ABHA014GTEH	ABHA018GTEH	ABHA024GTEH
Power source		Single phase, ~230 V, 50 Hz			
Capacity	Cooling	3.6	4.5	5.6	7.1
	Heating	4.0	5.0	6.3	8.0
Input power		30	42	74	99
Airflow rate	High	660	780	1,000	1,000
	Med-High	620	740	910	930
	Med	580	690	830	870
	Med-Low	550	640	750	800
	Low	520	600	660	740
	Quiet	490	550	580	680
Sound pressure level	High	36	40	46	47
	Med-High	34	39	44	45
	Med	33	38	42	43
	Med-Low	31	36	40	41
	Low	29	35	37	39
	Quiet	28	34	35	37
Net Dimensions (H × W × D)		mm 199 × 990 × 655	199 × 990 × 655	199 × 990 × 655	199 × 990 × 655
Weight		kg 25	26	26	27
Connection pipe diameter	Liquid (Flare)	6.35	6.35	6.35	9.52
	Gas (Flare)	12.70	12.70	12.70	15.88
Drain Hose Diameter (I.D./O.D.)		25/32			

Note: Specifications are subject to the following conditions:
 Cooling: Indoor temperature of 27°CDB/19°CWB, and outdoor temperature of 35°CDB/24°CWB.
 Heating: Indoor temperature of 20°CDB/15°CWB, and outdoor temperature of 7°CDB/6°CWB.
 Pipe length: 7.5 m; Height difference between outdoor unit and indoor unit: 0 m. Voltage: 230 [V]

Optional parts

*For more details, please refer to the chapter "Optional parts".

- External power supply unit: UTZ-GXXA, UTZ-GXXC*
 WLAN adapter: UTY-TFSXZ1, UTY-TFSXJ3, FG-AC-WIF1Z1

Dimensions

(Unit: mm)

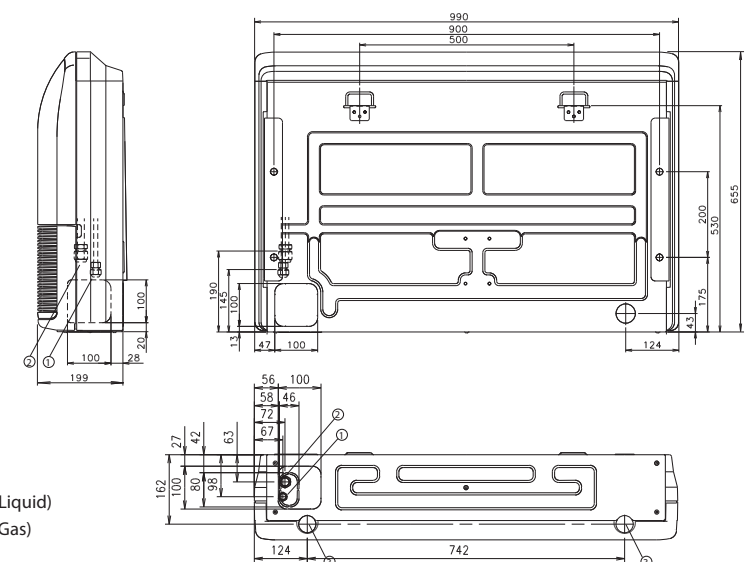

- ① Refrigerant pipe flare connection (Liquid)
- ② Refrigerant pipe flare connection (Gas)
- ③ Drain pipe connection

Ceiling



Installation

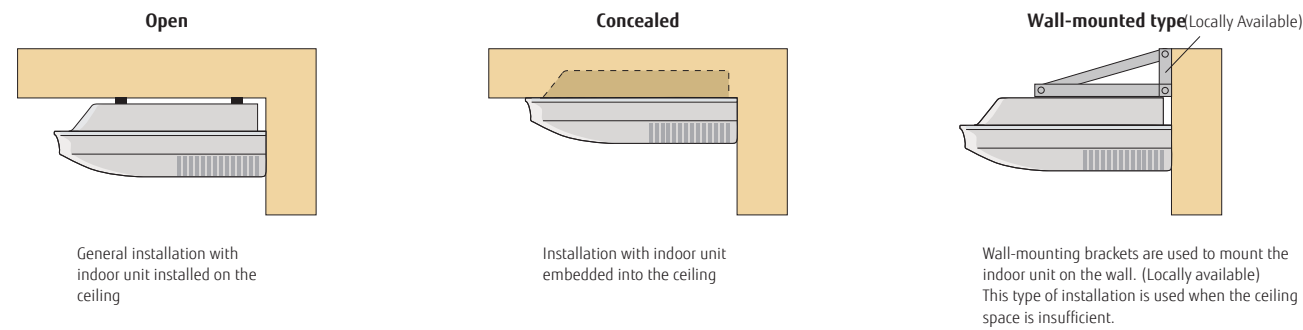

Double auto swing and wide airflow

Auto airflow direction and auto swing

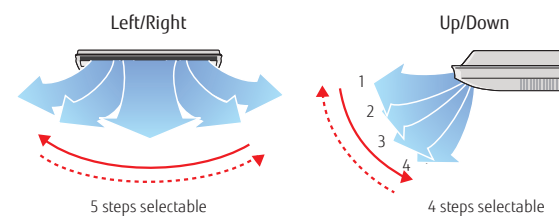

High-power DC fan motor

- High power
- Wide rotation range
- High-efficiency



Long airflow

Long airflow provides comfort in every corner of a large room.

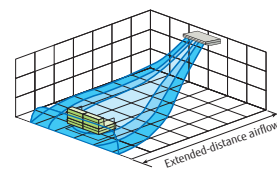

Fresh air intake

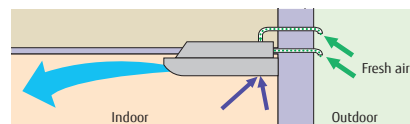

Slim & Compact design

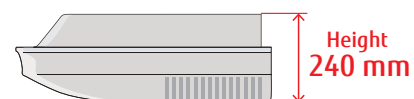

Model: ABHA030GTEH / ABHA036GTEH / ABHA045GTEH / ABHA054GTEH



Specifications

Model name		ABHA030GTEH	ABHA036GTEH	ABHA045GTEH	ABHA054GTEH
Power source		Single phase, ~230 V, 50 Hz			
Capacity	Cooling	9.0	11.2	12.5	14.0
	Heating	10.0	12.5	14.0	16.0
Input power		66	85	131	180
Airflow rate	High	1,630	1,690	2,010	2,270
	Med-High	1,520	1,560	1,840	2,070
	Med	1,420	1,450	1,690	1,860
	Med-Low	1,320	1,360	1,530	1,660
	Low	1,220	1,270	1,380	1,470
	Quiet	1,140	1,170	1,230	1,280
Sound pressure level	High	42	45	48	51
	Med-High	40	41	46	49
	Med	39	39	45	46
	Med-Low	37	38	41	43
	Low	35	36	38	40
	Quiet	33	34	35	36
Net Dimensions (H × W × D)		mm 240 × 1,660 × 700	240 × 1,660 × 700	240 × 1,660 × 700	240 × 1,660 × 700
Weight		kg 46	48	48	48
Connection pipe diameter	Liquid (Flare)	9.52	9.52	9.52	9.52
	Gas (Flare)	15.88	15.88	15.88	15.88
Drain Hose Diameter (I.D./O.D.)		25/32			

Note: Specifications are subject to the following conditions:
Cooling: Indoor temperature of 27°CDB/19°CWB, and outdoor temperature of 35°CDB/24°CWB.
Heating: Indoor temperature of 20°CDB/15°CWB, and outdoor temperature of 7°CDB/6°CWB.
Pipe length: 7.5 m; Height difference between outdoor unit and indoor unit: 0 m. Voltage: 230 [V]

Optional parts

*For more details, please refer to the chapter "Optional parts".

- Drain pump unit: UTR-DPB24T
- Flange: UTD-RF204
- External power supply unit: UTZ-GXXA, UTZ-GXXC*
- WLAN adapter: UTY-TFSXZ1, UTY-TFSXJ3, FG-AC-WIF1Z1

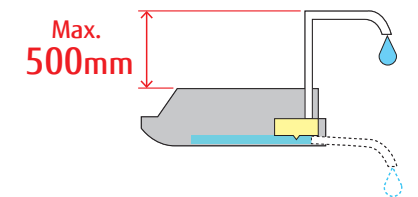

Dimensions

(Unit: mm)

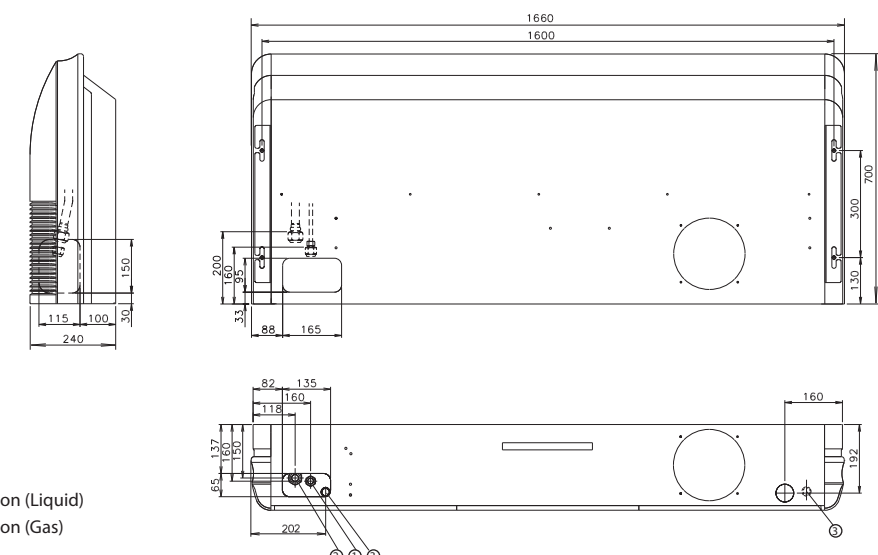

Wall-mounted type



Highly-efficiency, compact design

The 004-014 models share the same design. The high-density and large heat exchanger achieves a highly-efficiency and compact design. The compact body blends in well with conference rooms and offices, providing comfortable air conditioning.

High-density heat exchanger

Slim tube design: 5 mm
Greater heat-exchanging capacity is achieved through the use of a high-density heat exchanger and a sub-heat exchanger.

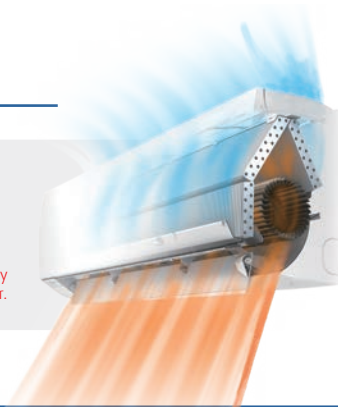

More comfortable airflow

The unique power diffuser provides comfortable air conditioning.

Heating

The vertical airflow provides powerful floor-level heating.



Cooling

The left/right airflow avoids blowing cool air directly at the occupants in a room.



Quiet operation & 6-Step fan speed control

The airflow pattern achieves significant noise reduction. Multistep airflow adjustment to suit the environment

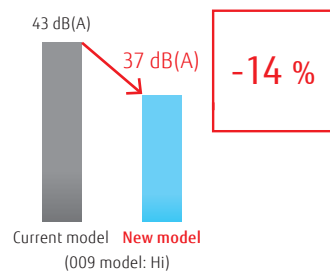

- 6-Step Speed
- High
- Med-High
- Med
- Med-Low
- Low
- Quiet

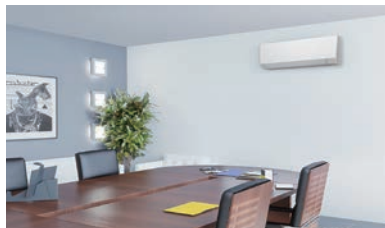

* Remote controller is compatible with the following:
UTY-RNRGZ5/UTY-RLRG/UTY-RSRG/UTY-RHRG/UTY-DCGGZ2/UTY-ALGX1/UTY-APGX1

The Occupancy sensor contributes to further energy savings.

Energy saving operation starts automatically by detecting the motion of a person. Two modes of save operation mode and stop mode can be selected.

*If you want to use the Occupancy sensor control function, you need a setting device that can set the Occupancy sensor control function. For example: Wired RC (Touch panel).

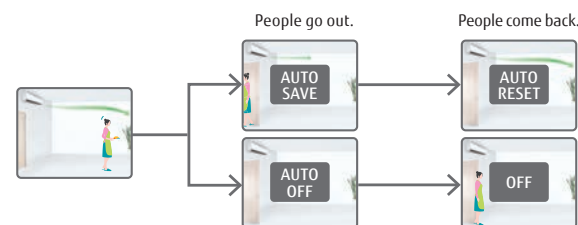

Model: ASHA004GCGH / ASHA007GCGH / ASHA009GCGH / ASHA012GCGH / ASHA014GCGH
[external EEV]
ASHE004GCEH / ASHE007GCEH / ASHE009GCEH / ASHE012GCEH / ASHE014GCEH



Specifications

Model name	ASHA004GCGH	ASHA007GCGH	ASHA009GCGH	ASHA012GCGH	ASHA014GCGH	ASHE004GCEH	ASHE007GCEH	ASHE009GCEH	ASHE012GCEH	ASHE014GCEH		
Power source	Single phase, ~230 V, 50 Hz					Single phase, ~230 V, 50 Hz						
Capacity	Cooling	kW				1.1	2.2	2.8	3.6	4.0	4.0	
	Heating	1.3	2.8	3.2	4.0	4.5	1.3	2.8	3.2	4.0		
Input power	W		12	19	20	25	36	12	19	34	25	36
	Airflow rate	High	450	550	610	690	800	450	550	610	690	800
Med-High		430	510	560	610	740	430	510	560	610	740	
Med		400	470	510	560	680	400	470	510	560	680	
Med-Low		380	410	440	530	610	380	410	440	530	610	
Low		360	360	360	470	550	360	360	360	470	550	
Quiet		310	310	310	330	330	310	310	310	330	330	
Sound pressure level	High	31	34	37	40	44	31	35	43	40	44	
	Med-High	30	32	35	37	42	30	32	38	37	42	
	Med	28	30	32	35	40	28	30	34	35	40	
	Med-Low	27	28	29	33	37	27	27	29	33	37	
	Low	26	26	26	30	34	26	24	24	30	34	
	Quiet	22	22	22	24	24	22	22	22	24	24	
Net Dimensions (H × W × D)	mm	268 × 840 × 203					268 × 840 × 203					
Weight	kg	8.0	8.5	8.5	8.5	8.5	8.0	8.5	8.5	8.5	8.5	
Connection pipe diameter	Liquid (Flare)	mm										
	Gas (Flare)	6.35	6.35	6.35	6.35	6.35	6.35	6.35	6.35	6.35	6.35	
Drain Hose Diameter (I.D./O.D.)	mm	13.8/15.8 to 16.7					13.8/15.8 to 16.7					
EV kit (optional)		-					UTR-EV09XB		UTR-EV14XB			

Note: Specifications are subject to the following conditions:
Cooling: Indoor temperature of 27°CDB/19°CWB, and outdoor temperature of 35°CDB/24°CWB.
Heating: Indoor temperature of 20°CDB/15°CWB, and outdoor temperature of 7°CDB/6°CWB.
Pipe length: 7.5 m; Height difference between outdoor unit and indoor unit: 0 m. Voltage: 230 [V]
When connecting ASH*004G**H, ASH*007G**H, ASH*009G**H to an outdoor unit other than the outdoor unit of the J-IVL Series, the gas pipe diameter should be Ø12.70 mm.

Optional parts

*For more details, please refer to the chapter "Optional parts".

- External power supply unit: UTZ-GXXA, UTZ-GXXC*
- WLAN adapter: UTY-TFSXZ1, UTY-TFSXJ3, FG-AC-WIF1Z1
- Silver Ion Filter: UTR-FA16-5

Dimensions

(Unit: mm)

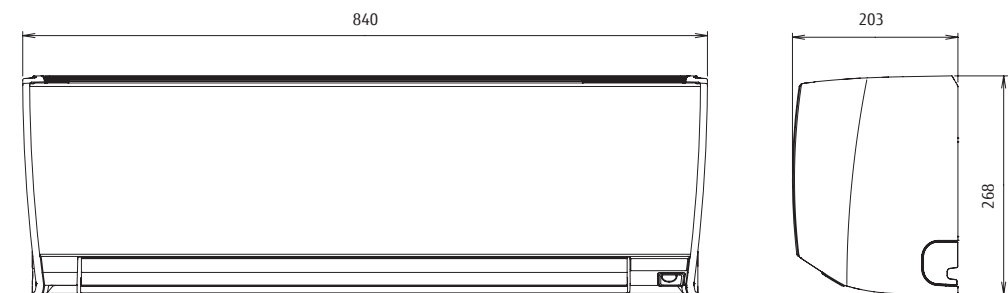

Wall-mounted type



Powerful & Comfort airflow

Powerful Airflow

(ASHA030GTEH)

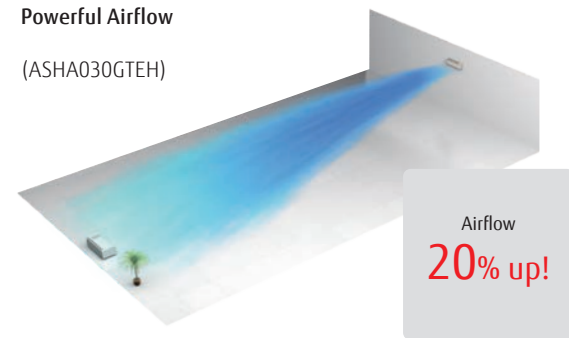

Power diffuser

(ASHA18/24GBCH)

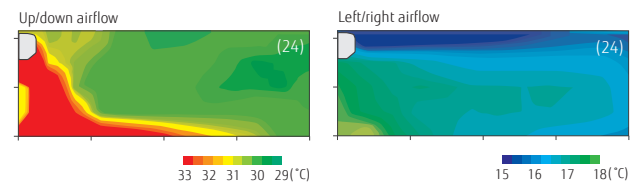

The Occupancy sensor contributes to further energy savings. (ASHA030/034GTEH only)

Energy saving operation starts automatically by detecting the motion of a person. Two modes of save operation mode and stop mode can be selected.

*If you want to use the Occupancy sensor control function, you need a setting device that can set the Occupancy sensor control function. For example: Wired RC (Touch panel).

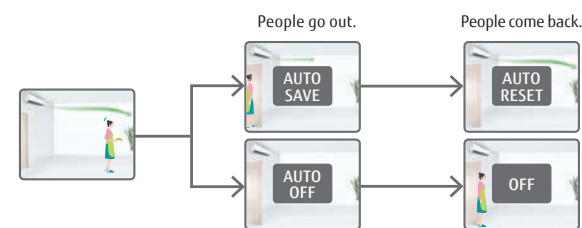

6-step fan speed control for quiet operation

The airflow pattern achieves significant noise reduction. A 6-step sound level setting allows for multiple-step silent operations.

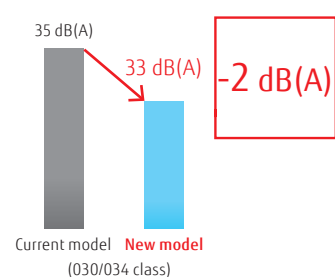

- 6-Step Speed
- High
- Med-High
- Med
- Med-Low
- Low
- Quiet



* Remote controller is compatible with the following: UTY-RNRGZ5/UTY-RLRG/UTY-RSRG/UTY-RHRG/UTY-DCGG22/UTY-ALGXZ1/UTY-APGXZ1

Model: ASHA18GBCH / ASHA24GBCH
ASHA030GTEH / ASHA034GTEH



ASHA18/24GBCH



ASHA030/034GTEH

Specifications

Model name		ASHA18GBCH	ASHA24GBCH	ASHA030GTEH	ASHA034GTEH
Power source		Single phase, ~230 V, 50 Hz			
Capacity	Cooling	5.6	7.1	9.0	10.0
	Heating	6.3	8.0	10.0	11.2
Input power		32	60	74	103
Airflow rate	High	840	1,100	1,440	1,620/1,520
	Med-High	-	-	1,200	1,300
	Med	770	910	1,050	1,120
	Med-Low	-	-	940	980
	Low	690	730	890	890
	Quiet	-	-	700	700
Sound pressure level	High	41	48	53	55/54
	Med-High	-	-	49	51
	Med	39	43	45	47
	Med-Low	-	-	42	43
	Low	35	35	39	39
	Quiet	-	-	33	33
Net Dimensions (H × W × D)		mm 320 × 998 × 238	320 × 998 × 238	340 × 1,150 × 280	340 × 1,150 × 280
Weight		kg 15	15	18	18
Connection pipe diameter	Liquid (Flare)	6.35	9.52	9.52	9.52
	Gas (Flare)	12.70	15.88	15.88	15.88
Drain Hose Diameter (I.D./O.D.)		12/16		13.8/15.8 to 16.7	

Note: Specifications are subject to the following conditions:
Cooling: Indoor temperature of 27°CDB/19°CWB, and outdoor temperature of 35°CDB/24°CWB.
Heating: Indoor temperature of 20°CDB/15°CWB, and outdoor temperature of 7°CDB/6°CWB.
Pipe length: 7.5 m; Height difference between outdoor unit and indoor unit: 0 m. Voltage: 230 [V].
When connecting ASHA18GBCH to an outdoor unit other than the outdoor unit of the J-IVL Series, the pipe diameter should be Ø9.52/Ø15.88 mm (Liquid/Gas).

Optional parts

- External power supply unit: UTZ-GXXA (030/034), UTZ-GXXC* (030/034)
- Silver Ion Filter: UTR-FA13-3
- WLAN adapter: UTY-TFSXJ3 (030/034), UTY-TFSXZ1 (030/034)
FG-RC-WIF122 (18/24), FG-AC-WIF121 (030/034)

Dimensions

(Unit: mm)

Models: ASHA18/ASHA24

Models: ASHA030/ASHA034

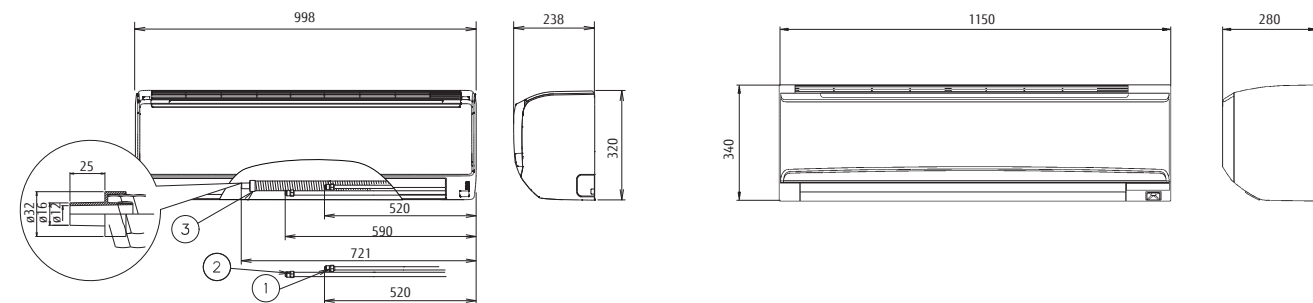

- ① Refrigerant pipe flare connection (Liquid)
- ② Refrigerant pipe flare connection (Gas)
- ③ Drain pipe connection

Residential, Commercial & Light Commercial VENTILATION

VENTILATION Lineup



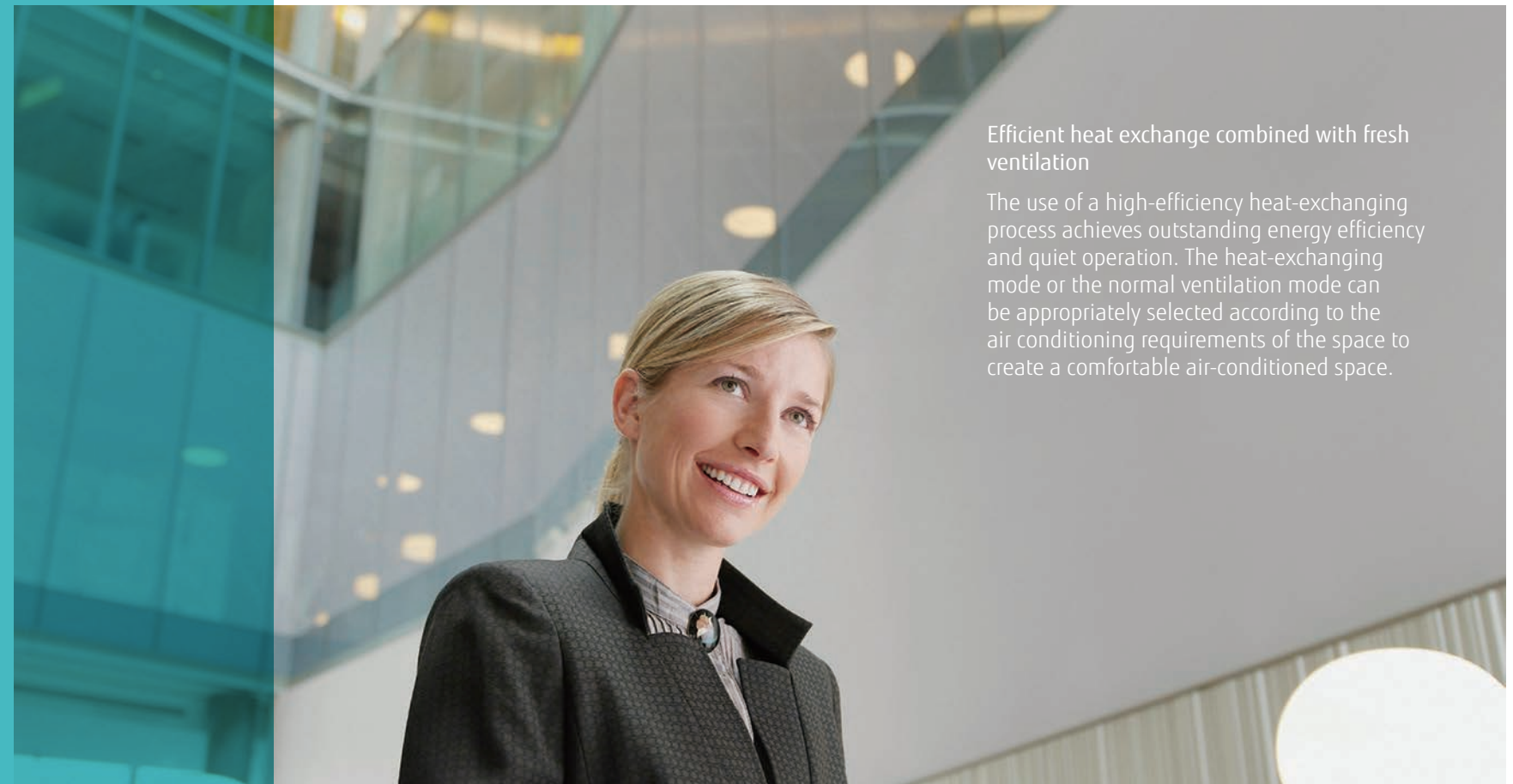











- Vn-002 Energy Recovery Ventilator
- Vn-004 DX kit for Air handling applications
 - for VRF Outdoor unit
- Vn-006 DX kit for Air handling applications
 - for Single Split Outdoor Units
- Vn-008 AIR HANDLING UNIT



Efficient heat exchange combined with fresh ventilation

The use of a high-efficiency heat-exchanging process achieves outstanding energy efficiency and quiet operation. The heat-exchanging mode or the normal ventilation mode can be appropriately selected according to the air conditioning requirements of the space to create a comfortable air-conditioned space.

Lineup

Airflow rate (m ³ /h)	250	350	500	800	1000					
Energy Recovery Ventilator	 UTZ-BD025C	 UTZ-BD035C	 UTZ-BD050C	 UTZ-BD080C	 UTZ-BD100C					
Connectable capacity class (kW)	5.0	6.3	8.0	10.0	12.5	14.0	20.0	25.0	40.0	50.0
DX kit for Air handling applications for VRF Outdoor unit	  EEV unit UTP-VX30A Control unit UTY-VDGX	  EEV unit UTP-VX60A Control unit UTY-VDGX	  EEV unit UTP-VX90A Control unit UTY-VDGX	  EEV unit UTP-VX90A × 2 Control unit UTY-VDGX						
Connectable capacity class (kW)	3.5 - 22.0									
DX-kit for Air handling applications for Single Split Outdoor Units	 UTY-XDZX									
Connectable capacity class (kW)	25 - 96									
Air handling unit	 AHHA / AHHB / AHHC / AHHD / AHHE									

Energy Recovery Ventilator



The energy recovery ventilator unit provides energy efficiency for comfort and improved savings.

Heat exchange ventilation and normal ventilation

Heat exchange ventilation

When a room is cooled or heated, the exhausted cooling or heating energy is recovered by heat exchange ventilation.

Normal ventilation

Used when the indoor space does not require cooling or heating, i.e., when there is little temperature difference between the indoor and outdoor environments.

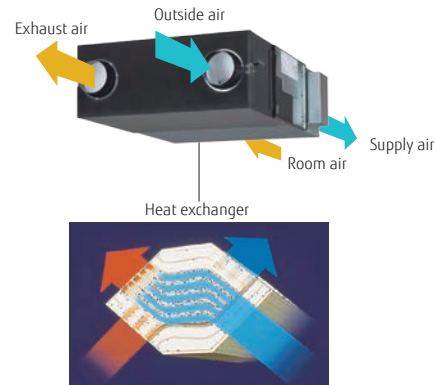

A high-efficiency counter-flow heat-exchanging element is used in the setup.

Energy efficiency and ecology

The use of a counter-flow heat-exchanging element, designed to recover up to 77% of heat from the outgoing air, significantly reduces energy consumption. The air conditioning load is reduced by approximately 20%, which results in substantial savings in energy cost.

Comparison of heat-exchanging elements

Air flows in a straight line through a crossflow element. In contrast, air flows for a longer time (a longer distance) through a counter-flow element to achieve more consistent heat-exchanging performance.

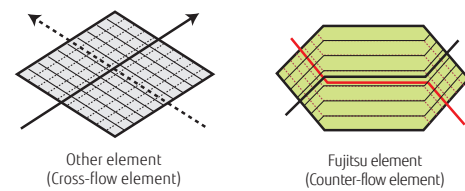

Quiet operation

Significantly lower noise levels are achieved by reducing pressure loss.

25.5dB
(UTZ-BD035C)

Extended range of external static pressure

The use of a powerful fan motor improves the external static pressure. This allows it to be installed in a variety of buildings.

Slim design for easier installation

The use of a counter-flow heat-exchanging element made it possible to design a quieter, slimmer unit.



Reverse-mountable direct air supply and exhaust system

Simplifies the duct design, due to its straight ducts for air supply and exhaust. Since each unit can be mounted facing opposite directions, only one inspection hole is needed for two units. This makes duct work easier and more flexible.

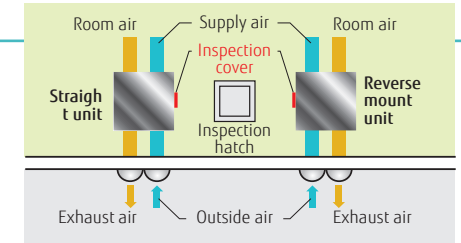

Simple remote operation

Easy operation with connected liquid crystal switch

- Power On/Off
- Air volume High/Low
- Heat exchange ventilation and normal ventilation
- On/Off Timer
- Clean filter display



Model: UTZ-BD025C/UTZ-BD035C/UTZ-BD050C/UTZ-BD080C/UTZ-BD100C

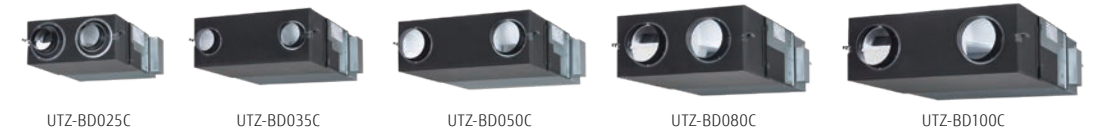

Specifications

Rated flow rate	250 m ³ /h		350 m ³ /h		500 m ³ /h		800 m ³ /h		1000 m ³ /h	
Model name	UTZ-BD025C		UTZ-BD035C		UTZ-BD050C		UTZ-BD080C		UTZ-BD100C	
Power source	Single phase, ~220 to 240 V, 50 Hz									
Heat Exchange Ventilation	Input power	(Extra high)/High/Low	W	128/123/96	190/185/168	289/225/185	418/378/295	464/432/311		
	Airflow rate	(Extra high)/High/Low	m ³ /h	250/25/190	350/350/240	500/500/440	800/800/630	1,000/1,000/700		
	External static pressure	(Extra high)/High/Low	Pa	105/95/45	140/60/45	120/60/35	140/110/55	105/80/75		
	Temperature exchange efficiency	(Extra high)/High/Low	%	75/75/77	75/75/78	75/75/76	75/75/76	75/75/79		
	Energy exchange efficiency cooling	(Extra high)/High/Low	%	63/63/65	66/66/71	62/62/64	65/65/68	65/65/70		
Normal Ventilation	Energy exchange efficiency heat pump	(Extra high)/High/Low	%	70/70/72	69/69/73	67/67/69	71/71/74	71/71/76		
	Sound pressure level	(Extra high)/High/Low	dB*	31.5/30.5/26.5	33.0/31.0/25.5	37.5/35.5/32.5	37.5/37.0/34.5	38.5/37.5/34.5		
	Input power	(Extra high)/High/Low	W	128/123/96	190/185/168	289/225/185	418/378/295	464/432/311		
	Airflow rate	(Extra high)/High/Low	m ³ /h	250/25/190	350/350/240	500/500/440	800/800/630	1,000/1,000/700		
	External static pressure	(Extra high)/High/Low	Pa	105/95/45	140/60/45	120/60/35	140/110/55	105/80/75		
Sound pressure level	(Extra high)/High/Low	dB*	31.5/30.5/26.5	33.0/31.0/25.5	38.5/38.0/32.5	37.5/37.0/34.5	40.5/39.5/36.5			
Dimensions	W × D × H	mm		882 × 599 × 270	1,050 × 804 × 317	1,090 × 904 × 317	1,322 × 884 × 388	1,322 × 1,134 × 388		
Weight		kg		29	49	57	71	83		
Outlet duct diameter		mm		150	150	200	250	250		
Operating range		°C		-10 to 40	-10 to 40	-10 to 40	-10 to 40	-10 to 40		
Maximum humidity		%		85	85	85	85	85		

* Noise level measured 1.5 m below the center of the unit

Dimensions

(Unit: mm)

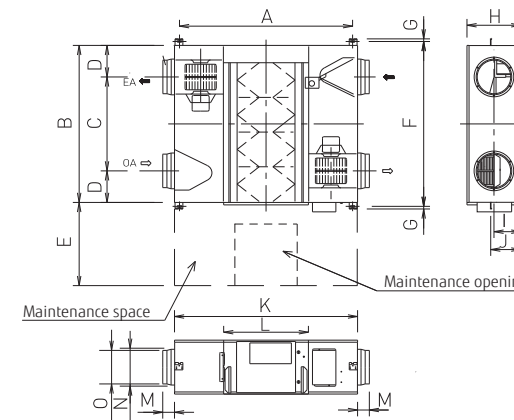

	UTZ-BD025C	UTZ-BD035C	UTZ-BD050C	UTZ-BD080C	UTZ-BD100C
A	810	978	1,018	1,250	1,250
B	599	804	904	884	1,134
C	315	580	640	428	678
D	142	112	132	228	228
E	600	600	600	600	600
F	655	860	960	940	1,190
G	19	19	19	19	19
H	270	317	317	388	388
I	135	159	159	194	194
J	159	182	182	218	218
K	882	1,050	1,090	1,322	1,322
L	414	470	470	612	612
M	95	70	70	85	85
N	Ø164	Ø164	Ø210	Ø258	Ø258
O	Ø144	Ø144	Ø194	Ø242	Ø242

DX kit for Air handling applications for VRF Outdoor unit



With these kits, air handling units (AHUs) and fan coil units (FCUs) from other manufacturers can be incorporated into Fujitsu General VRF systems, or one AHU can be connected to one Fujitsu General VRF dedicated outdoor unit to control outdoor ventilation and room temperatures.

Multiple temperature sensors optimally control an Air handling unit and a fan coil unit.

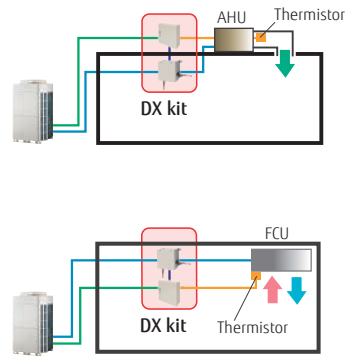

When connected to an Air handling unit, the temperature of supply air is controlled by a discharge air sensor.

When connected to a fan coil unit, the room temperature is controlled by the discharge air sensor.

Application as part of a VRF system

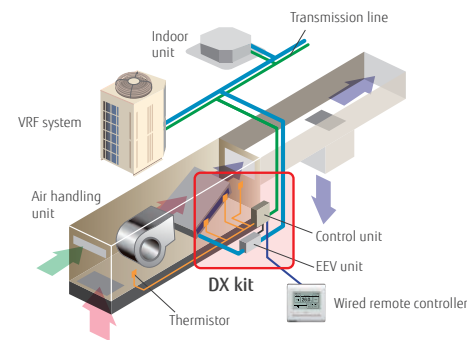

Supports a wide range of capacity classes

- Two EEV units can be connected in parallel to large-capacity units of up to 20 HP (50 kW). (UTP-LX180A separation tube required)
- Connectable capacity range: 5 kW to 50 kW

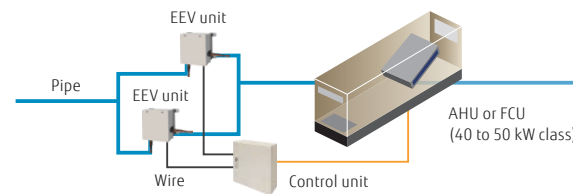

A variety of control options that meet application requirements

Central control enabled by our VRF controllers or central management controllers

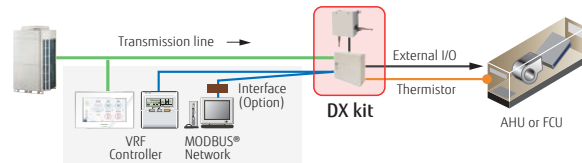

Central control from external controllers

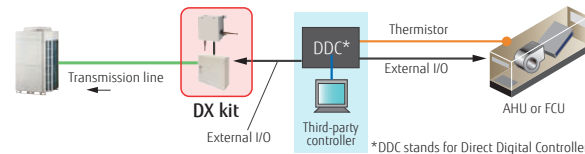

*DDC stands for Direct Digital Controller

Summary of functions

Inputs

- On/Off
- Setting temperature
- Capacity demand
- Heating/Cooling operation modes
- Fault information

Outputs

- On/Off indication
- Fan On/Off indication
- Thermostat On/Off indication
- Defrost indication
- Fault indication

MODBUS® Control

Can be controlled via a MODBUS®-enabled BMS using an optional interface.

Installation requirements

- Connectable VRF Series: All VRF Series
- Capacity range of connectable DX kit systems with outdoor units: 50 to 100% of capacity
- Capacity range of connectable DX kit systems with indoor units: 30% or less of capacity
- Max. wire length from a control unit: 10 m
- Max. pipe length between EEV unit and indoor unit: 5 m
- A control unit (IP54 class) and an EEV unit can be installed outdoors.

Connectable capacity

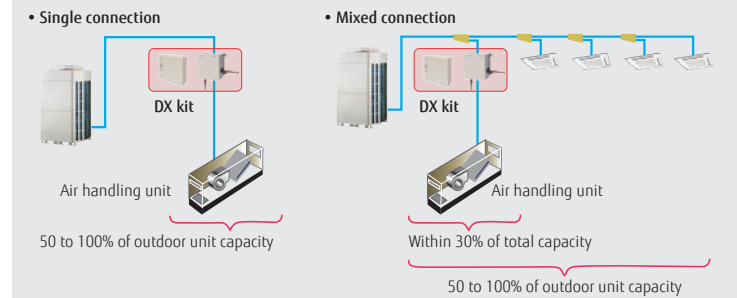

Pipe and wire length

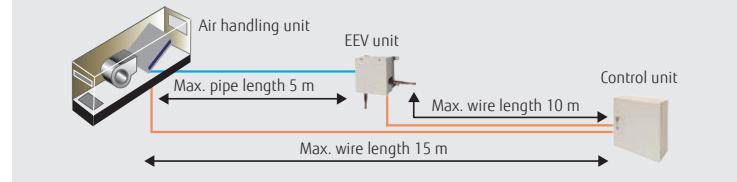

Optional separation tube to connect two EEV units: UTP-LX180A



Control unit: UTY-VDGX EEV unit: UTP-VX30A/UTP-VX60A/UTP-VX90A

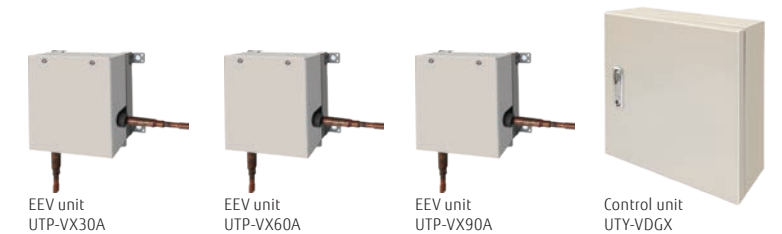

Specifications

Connectable capacity class		5.0 kW	6.3 kW	8.0 kW	10.0 kW	12.5 kW	14.0 kW	20.0 kW	25.0 kW	40.0 kW	50.0 kW
Capacity	Cooling	5.6	6.3	8.0	10.0	12.5	14.0	22.4	25.0	40.0	50.4
	Heating	6.3	7.1	9.0	11.2	14.0	16.0	25.0	28.0	45.0	56.5

Control unit		UTY-VDGX			
Power source		230/1/50			
Dimensions (H × W × D)	mm	400 × 400 × 120			

EEV unit		UTP-VX30A	UTP-VX60A	UTP-VX90A	UTP-VX90A × 2
Connection pipe diameter (Liquid)	mm	Ø9.53	Ø12.70	Ø12.70	Ø12.70
Dimensions (H × W × D)	mm	160 × 220 × 90			

Note: Specifications are based on the following conditions.
Cooling: Indoor temperature of 27°CDB/19°CWB, and outdoor temperature of 35°CDB/24°CWB.
Heating: Indoor temperature of 20°CDB/15°CWB, and outdoor temperature of 7°CDB/6°CWB.
Pipe length: 7.5 m Voltage: 230 [V].

DX kit for Air handling applications for Single Split Outdoor Units



With this kit, other manufacturers' Air handling units (AHUs) and fan coil units (FCUs) can be incorporated into Fujitsu General Split outdoor units.

Flexible connectivity

This kit allows connections to third-party equipment. This control unit can also be used in conjunction with Fujitsu General single-split outdoor units, providing a perfect solution when a stand-alone Air handling unit is needed.

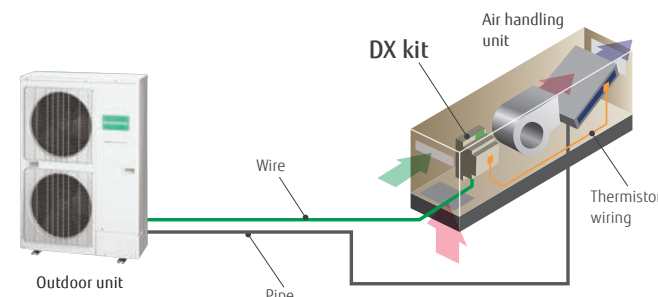

Supports a wide range of capacity classes

Capable of connecting large capacities in the range of 3.5 kW to 22.0 kW (Nominal)



Mobile devices allow for operation from anywhere

Can be operated and managed remotely using your smartphone or tablet.

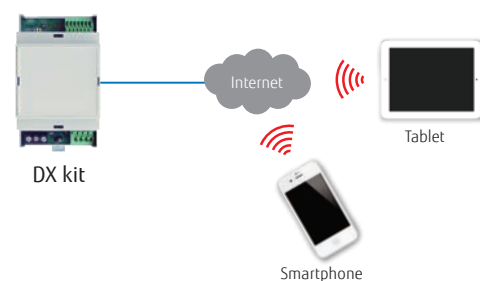

Summary of functions

Inputs

- On/Off
- Heating/Cooling operation modes
- Capacity demand (analogue 0 to 10 V)
- Heat exchanger temperature

Outputs

- Status of Compressor, Defrost, and Errors (Potential free relays)
- Status indicator with LED

Wireless LAN Control

Wireless LAN control through cloud connectivity enables secure remote monitoring and control from anywhere.

Easy installation

- Compact DIN rail mountable enclosure for easy installation
- No expansion device required
- No separate external power supply required

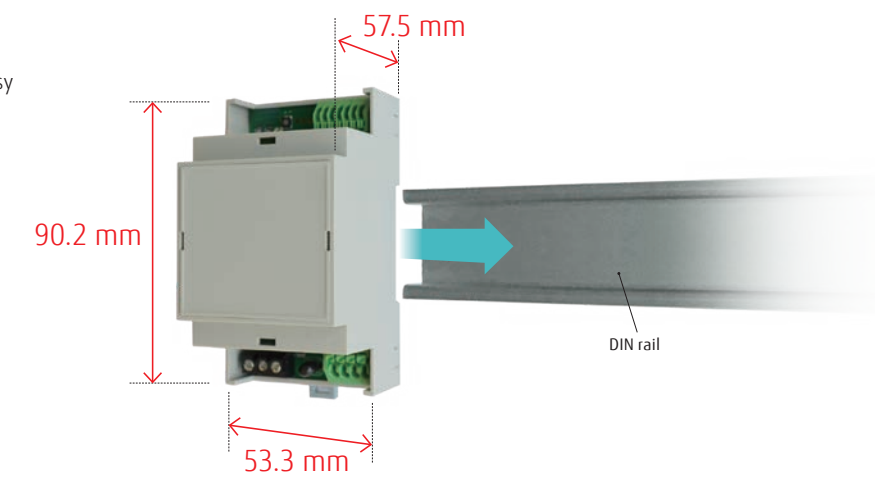

Model: UTY-XDZX



Specifications

BTU	12	14	18	24	30	36	45	54	60	72	90	
Capacity (Nominal)	Cooling	3.5	4.3	5.2	6.8	8.5	9.4	12.1	13.3	15.0	19.0	22.0
	Heating	4.1	5.0	6.0	7.8	10.0	10.8	13.3	15.8	18.0	22.4	27.0
Model name		UTY-XDZX										
Power source		230/1/50										
Dimensions (H × W × D)		90.2 × 53.3 × 57.5										
Weight		110										

Note: Specifications are based on the following conditions.
Cooling: Indoor temperature of 27°CDB/19°CWB, and outdoor temperature of 35°CDB/24°CWB.
Heating: Indoor temperature of 20°CDB/15°CWB, and outdoor temperature of 7°CDB/6°CWB.
Pipe length: 5.0 m Voltage: 230 [V].



Light Commercial & Commercial AIR HANDLING UNIT

- Vn-010 System Overview
- Vn-012 VRF Series Lineup
- Vn-014 Air Handling Units Overview
- Vn-016 Features
 - Structure
 - Filtration
 - Thermal Exchange Sections
 - Fan Section
 - Humidifier
 - Heat Recovery Section
- Vn-022 Dimensions
- Vn-025 Loose Accessories
- Vn-026 Total Pressure Drop
- Vn-027 Fan Characteristic Curves
- Vn-030 Specifications
- Vn-032 Control System
 - AHU Controller
 - System controller (System controller Lite)



FUJITSU GENERAL (Euro) GmbH participates in the ECP program for AHU. Check ongoing validity of certificate: www.eurovent-certification.com



System Overview

Air handling applications available in Fujitsu General VRF system realize high energy efficiency and superior comfort to flexibly adapt to the stringent air conditioning requirements and installation conditions of a wide variety of facilities.

The system consists of VRF outdoor units of 10 to 48 HP and thermal ventilation and air conditioning units for civil and industrial use, covering airflow ranges from 4,300 to 18,100 m³/h with cooling capacities from 25 to 96 kW.



AHU CONTROLLER



SYSTEM CONTROLLER



Controller line

Controller line

Transmission line

Transmission line

Pipe line

AHU
AIR HANDLING UNIT

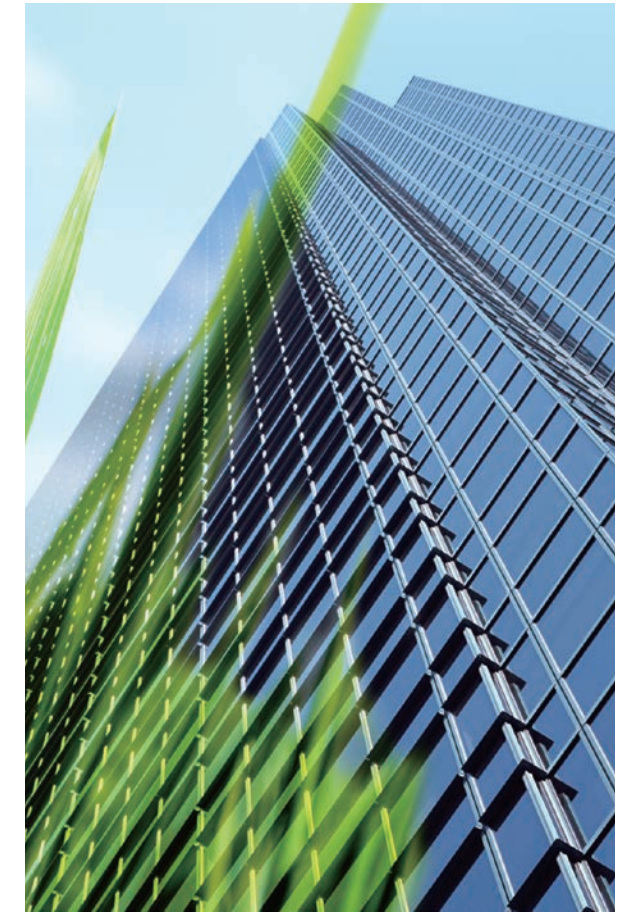

Advantages of the System

Full comfort

This system provides clean, fresh air with advanced filtration and balanced temperatures to increase comfort and air quality in a building.

Simple design, easy installation

Equipped with a DX kit (Electronic Expansion Valve and PCB), AHU facilitates installation design. The AHU model can be easily configured using the Selection Software.







































Total solution concept

Integrating an AHU into the building climate control system simplifies the design and installation processes based on a single, common technology. From project follow-up through to installation, commissioning, and maintenance, all procedures are simplified. The above features allow a single installation company to carry out design, installation, and commissioning.

- For AHU control: AHU controller (Only For AHU)
 * For mixed connection control: System controller, or third-party controller with MODBUS® converter

VRF Series Lineup

Fujitsu General's VRF series is a multi-type air conditioning system for buildings tailored to the scale and application of the building.

Capacity (kW)	28.0	33.5	40.0	45.0	50.4	55.9	61.5	67.0	73.5	78.5	85.0	90.0	95.0	100.5	107.0	112.0	118.5	123.5	130.0	135.0	
HP	10	12	14	16	18	20	22	24	26	28	30	32	34	36	38	40	42	44	46	48	
J-IVL Series	 AJH090 LELDH	 AJH108 LELDH	 AJH126 LELDH	 AJH144 LELDH	 AJH162 LELDH																
V-IV Series Heat Pump	Space Saving	 AJH090 LALDH	 AJH108 LALDH	 AJH126 LALDH	 AJH144 LALDH	 AJH162 LALDH	 AJH180 LALDH	 AJH198 LALDH	 AJH216 LALDH	 AJH234 LALDH	 AJH252 LALDH	 AJH270 LALDH	 AJH288 LALDH	 AJH306 LALDH	 AJH324 LALDH	 AJH342 LALDH	 AJH360 LALDH	 AJH378 LALDH	 AJH396 LALDH	 AJH414 LALDH	 AJH432 LALDH
	Energy Efficiency				 AJH144 LALDHH	 AJH180 LALDHH	 AJH216 LALDHH	 AJH234 LALDHH	 AJH252 LALDHH	 AJH270 LALDHH	 AJH288 LALDHH	 AJH306 LALDHH	 AJH324 LALDHH	 AJH342 LALDHH	 AJH360 LALDHH	 AJH378 LALDHH	 AJH396 LALDHH				
				Set Model																	



VRF J-IVL

for Small Offices

Fujitsu General provides air conditioning systems for a wide range of applications, from residences, small offices, hotels, to large retailers.



VRF V-IV

for Large Office

Smart, cutting-edge design Available in a wide range of models from 10 to 48 HP in 2 HP increments, with the capacity ratio of indoor units connectable up to 100%.

Air handling units Overview



The Air handling unit (AHU) is designed to be connected with VRF series outdoor units for thermal ventilation and air conditioning of civil and industrial buildings. With airflow rates ranging from 4,300 to 18,100 m³/h and cooling capacities from 25 to 96 kW, a variety of models and multiple additional modules are available to meet diverse installation needs.

The AHU is made of extruded aluminum profiles and nylon angle bars. The "sandwich-type" double-skin panels (50 mm thick), made of surface coating pre-painted galvanized sheets and high-density polyurethane foam insulation, are fixed to the unit by an aluminum snap-in locking system.

The AHU fan section in the EC inverter Plug Fans provides constant airflow and constant available static pressure with an automatic control system. An electronic device with a pressure sensor mounted in the system and a control sensor on the EC inverter Plug Fans adjust the airflow rate and the available static pressure to keep the airflow constant.

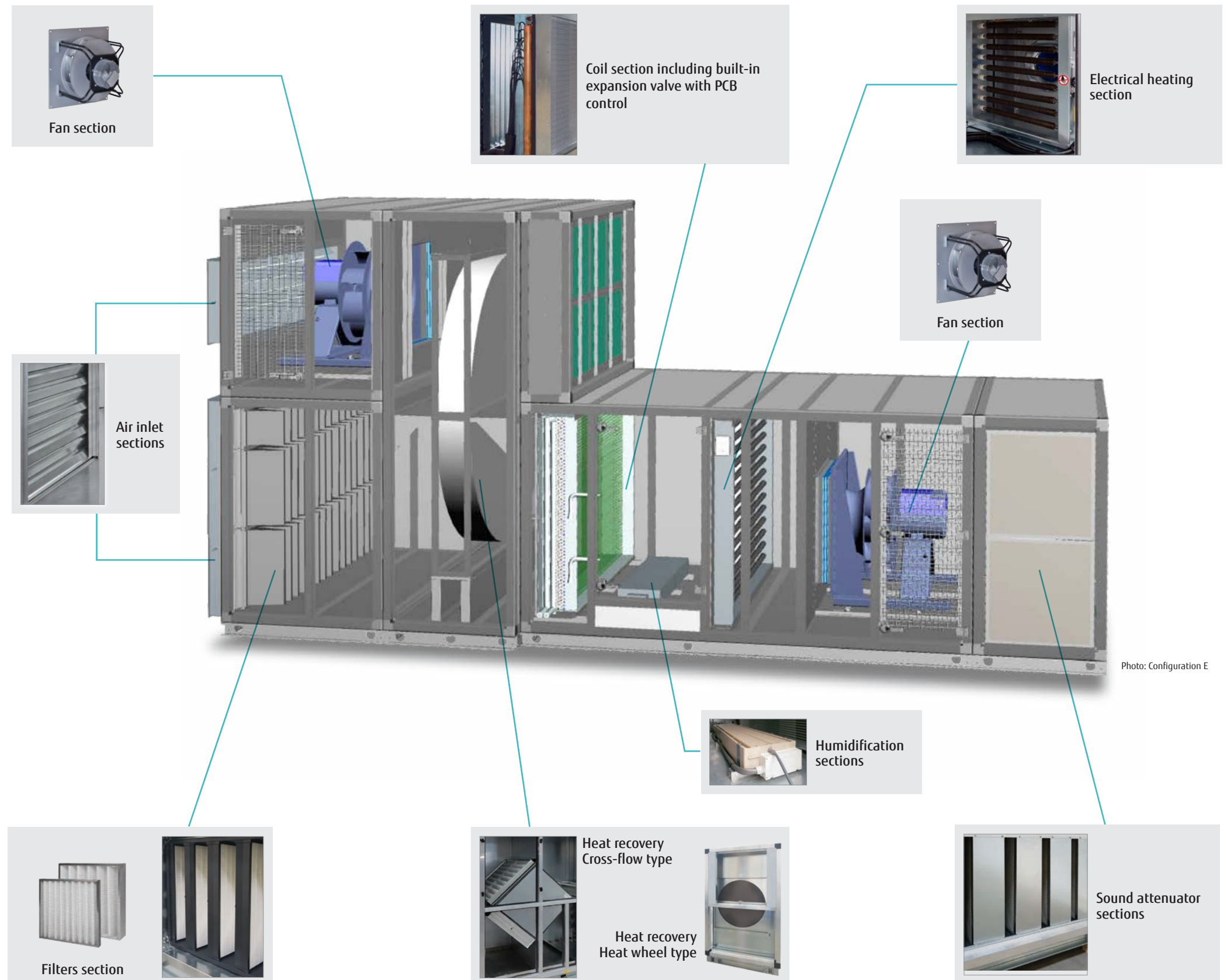

Photo: Configuration E

5 configurations are available

Configuration A
In line with Front damper
 For fresh air operation up to 100% external air

Configuration B
In line with Top inlet damper
 For fresh air operation up to 100% external air

Configuration C
In line with Inlet mixing box
 For fresh air operation up to 20% external air

Configuration D
Double deck with Cross-flow heat exchanger

Configuration E
Double deck with heat wheel

Feature



Structure

Section of extruded profile 62 × 62 mm (SNAP-IN system)

- The Air handling units are manufactured with a bearing framework and sandwich paneling.
- The frame is made of extruded anti-corrosive aluminum alloy profile, AlMgSi 0.5- UNI 9006/1.

Mechanical characteristics of extruded aluminium alloy

Denomination	Specific weight (kg/dm ³)	Unitary load of traction break R (kg/mm ²)	Yielding load S (0,2) (kg/mm ²)	Stretch (%)	Brinell hardness (kg/mm ²)
ANTICORODAL 050 UNI 9006/1 EX UNI 3569 (6060) ISO - Al Mg Si 0.5	2,70	20 ÷ 23	16 ÷ 20	12 ÷ 15	60 ÷ 70

Profile

- Fujitsu General's proprietary bearing has an actual size of 62 × 62 mm and an aluminum locking panel system (SNAP-IN system). This system enables uniform tightness of the panels that has not been achieved with the previous self-drilling screw fasteners, and thus ensures a degree of adhesion in excess of 2,500 Pa (10 in.W.G.). This profile, with no internal or external screws, provides a stronger and more beautiful appearance.
- The actual size of the panel used is 50 mm, due to the dimensions of the profile.
- In addition, the profile has no external sharp edges as prescribed by safety and accident prevention guidelines.
- The AHU is certified as meeting the most stringent performance standards.



- Fujitsu General units and all the internal components comply with ErP EcoDesign Directive 2018 Lot 6.
- Fujitsu General units comply with the European Standards UNE EN 1886 with respect to thermal and mechanical performances.

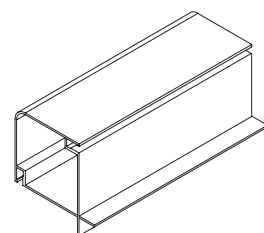
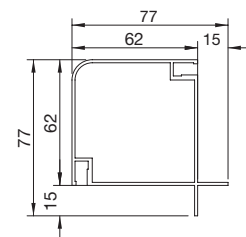

(Unit: mm)

Paneling

The panels are a double-skin sandwich type made of galvanized steel, with polyurethane foam insulation of a minimum density of 45 kg/m³ and an actual thickness of 50 mm.

The composition of the panel is as follows:

Inner skin: hot-dip galvanized sheet (galvanization thickness of not less than 140 g/m²), 5/10 mm thick

Insulation: rigid polyurethane foam (minimum density of 45 kg/m³, thermal conductivity 0.018 ÷ 0.024 w/m²•°C)

Outer skin: hot-dip, pre-painted galvanized sheet (galvanizing thickness of not less than 140 g/m²), 6/10 mm thick

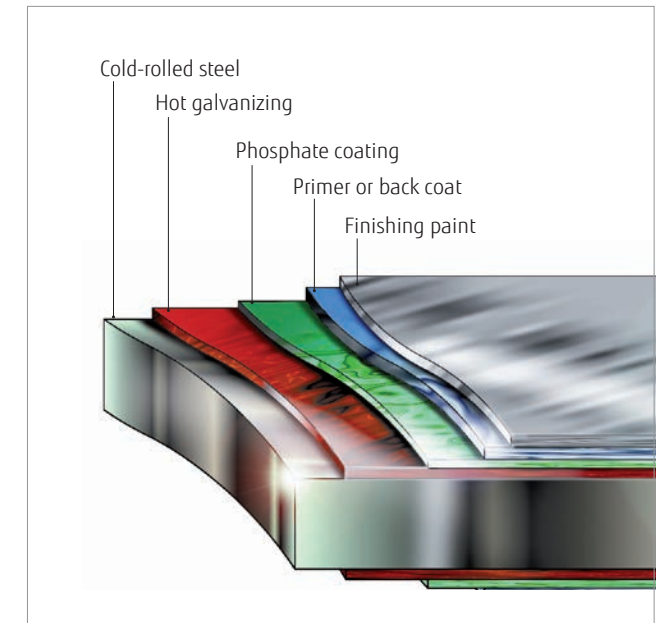

PRE-PAINTED GALVANIZED STEEL SHEET

Features of steel sheets

Hot-dipped galvanized steel sheet Fe P02 GZ 140 UNI EN 10142 with galvanization of not less than 140 g/m², 6/10 mm thick

Pre-painted steel sheet, 6/10 mm thick, with base support made of hot-dip galvanized steel with galvanization of not less than 140 g/m² Euronorm 142-79, a white-grey coating with excellent weather resistance. The protective system consists of a dry film of 25 µm on the exposed skin, and of a dry film of 5 µm on the non-exposed skin.

Film hardness: F on the Koh-i-Noor scale

Other chemical and physical properties:

- Resistance to salt spray exceeding 250 hours
- Resistance exceeding 1,000 hours in 100% relative humidity (ASTM D 714)
- Film resistance to cleaving and adhesion after bending (ECCA T7).

The exposed surface of the steel plate is covered with a self-adhesive PVC film to prevent damage during the manufacturing process and transportation.

Base frame

The bearing base frame is made of galvanized steel, the outline of which is pressure bent, bolted or welded, depending on the configuration of the unit.

Each part can be elevated and lowered, making it suitable for water and drain pipe.

The perimeter base frame is 100 mm high, C-shaped and bolted on all units.

The base frames for all of the above solutions are made of galvanized steel with a thickness of at least 2 mm.

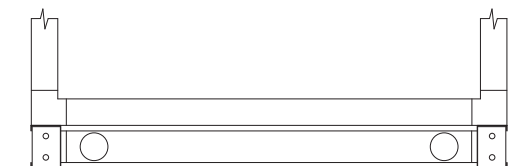

SECTION VIEW
The baseframe is flush with the panel.

Covering Roof (TT - Accessory)

- Units that are installed outdoors or that are frequently exposed to the weather can be fitted with a hot galvanized steel roof (with a galvanization of 140 g/m² or higher) as an accessory element.
- The roof overhang relative to the outer length of the unit is about 100 mm.
- All roof corners are equipped with protectors to prevent accidents.

Filtration

Plate Filters COARSE 55%

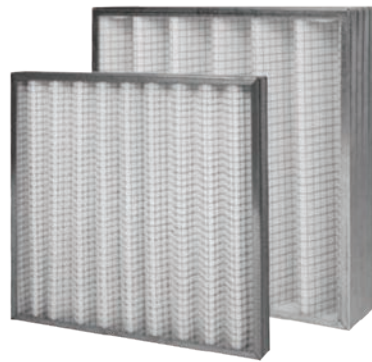

The plate filter filters air at low and medium efficiency.

- Plate filters are generally used as pre-filters to maintain the efficiency of the filters installed downstream for longer.
- Plate filters are installed on guides fixed inside the unit. In this case, the air by-pass will be minimal.

Plate filters are widely used due to the following features:

- Easy to remove
- Easy to obtain spare parts
- Highly regenerable, they can be cleaned with warm water and soap or common household detergent.

Features of Plate filters

- Galvanized steel sheet frame 48 mm thick
- Support containing net made of galvanized electrowelded wire
- Filtering material made of synthetic fiber with a filtration efficiency of COARSE 55%

Filtration

Bag Filters ePM1 50%



Bag filters are characterized by a large filtration area due to their bag-like shape, which greatly reduces the airflow velocity as the air passes through the filter.

The bags are installed on a galvanized slide and can be removed from the side. This filtering section includes an access door.

Features of soft bag filters

- Efficiency of ePM1 50%
- 287 mm deep
- Filter material made of fiberglass
- Galvanized steel sheet frame
- 80% of the material is recyclable
- Can be used even at 100% relative humidity.

N.B.: ePM1 50% bag filters are mandatory to comply with ECODSIGN ErP 2016.

Thermal Exchange Sections

DX Coil



Contents

- DX coil with copper tubes and aluminum fins, specifically designed to ensure a high thermal exchange rate and an excellent ratio of sensible and latent heat;
- One distributor and one electronic expansion valve for each circuit are connected to the control PCB, and the control PCB is located in close proximity to avoid interference, immunity, and electromagnetic interference problems;
- The temperature probes installed at the front, rear, and middle of the coil provide data to the control PCB, which in turn determines the opening of the electronic expansion valve according to the work point and the setpoint;

In multi-module units, the cooling circuits are interlaced to ensure full utilization of the exchange surface and the uniformity of the air being processed even under partial loads. The section includes the control PCB.

Thermal Exchange Sections

Electrical heating



Electrical heating section is used for heating and post-heating processing

The thermal exchange sections consist of:

- Galvanized steel sheet flanged containing frame
- Finned steel tubular heaters on base insulators
- Safety fix thermostat with manual reset
- Electric heating is assumed to have a capacity of up to 36 kW at 400 V/3-phase/50 Hz system.

Fan Section

EC Inverter Plug-Fan



The fan section is equipped with an EC Inverter Plug-Fan.

- EC Inverter Plug-Fans are electronically controlled to adjust the fan speed to provide airflow and static pressure according to the system capacity. By varying the airflow according to the required heat load, the system reduces energy consumption and noise, which is effective especially when partial loads are applied.
- The EC Inverter Plug-Fans allow the user to set various working conditions to meet the needs of the unit directly on site from the control panel on the Electrical Board section. If the wind is weaker than expected, for example, the operating conditions can be changed and adjusted with ease.
- Compared to traditional plug fans, the use of EC inverter technology has greatly improved the overall efficiency and acoustic properties of fans. The blade geometry with a diagonal trailing edge has positive effects on the aerodynamic performance and on the smoothness of fan rotation. The same holds true for the contour of the mounted nozzle.
- By integrating the EC motor directly into the impeller with the fan, the overall dimensions of the section can be minimized. There is no need for the commonly used belt drive between the motor and the fan. This reduces the amount of installation required and associated installation work.
- The EC inverter Plug Fans substantially exceed the requirements for energy efficiency class A+ requirements listed in the German Manufacturers Association RLT Directive 01 "General Requirements for Ventilation and Air Conditioning Equipment" and in the ErP2015 standards respectively.
- The EC inverter Plug Fans used in the fan section of the AHU provide constant airflow and constant available static pressure with an automatic control system. An electronic device with a pressure sensor mounted in the system and a control sensor on the EC inverter Plug Fans adjust the airflow rate and the available static pressure to keep the airflow constant.

Humidifier



Electrode humidifiers specifically designed for installation inside Air handling units

- The humidifier consists of two electrically connected parts: a hydraulic part and a control unit based on a microprocessor board. The hydraulic part is completely inserted into the AHU, and sits on top of the drain tank immediately downstream of the cooling coil.
- This control is fully integrated into the microprocessor in the AHU.
- The hydraulic boiler consists of a plastic polypropylene channel with a cross section of 33 cm × 16 cm high and a length proportional to the width of the AHU. Stainless steel electrodes are placed vertically inside the boiler, connected to the power supply, and are easily removable. The plastic lid is inclined so that any condensation will drain into the boiler in order to avoid power losses.
- Narrow longitudinal slots between the plastic sections allow air to fill the entire length of the AHU section by outputting the generated steam.
- This prevents condensate from being generated in the pipes and also prevents the steam pressure in the boiler from rising due to clogging of the steam pipes.

On one side of the kettle, there is a body for hydraulic management of the system, which can be easily accessed after installation.

- Maximum water level sensor
- The drainage block is specially designed to empty the tank of water and limestone debris without blocking the tank or interrupting the flow of water, allowing the work to be done without applying pressure.

An electronic rotation sensor grafted to the pivot motor communicates with the microprocessor to manage correct operation, and any malfunctions are indicated on the display.

Heat Recovery Section

Cross-flow heat recovery



The efficiency of the recovery unit is up to 85%.

- The fixed plate static recovery units are air-to-air with no moving parts, making the system reliable and safe. The air moves in a cross flow, where heat is transferred directly from the hotter stream to the cooler stream. The efficiency of the recovery unit is up to 85%.
- This type of heat exchanger is made of pressed aluminum sheets and is housed at various intervals depending on the type of use.
- The edges are sealed to prevent renewed air from being contaminated from polluting agents contained in exhaust air.

Normal supply is assumed to be as follows:

- Recovery units with aluminum fins
- Cell prefilters COARSE 55% (85% efficiency) installed on the fresh air side
- Galvanized steel sheet drain pan to collect possible condensation

Heat Recovery Section

Heat Wheel Recovery Units



The principle of operation is as follows:

- The exhaust air travels across the semi-circular rotor sector, transferring some of its heat to the metal mass. As the exhaust passes through the half circular rotor sector, it transfers heat to the metal parts, which in turn transfers the heat to the fresh, cool air drawn in from outside through the other side of the half circular rotor sector, thus allowing ventilation without cooling the room. When the rotor is of the hygroscopic type, the humidity contained in the exhaust air will also be partially transferred to the regenerative air.
- The terms "warm air" and "cold air" as used above are valid for the winter operating cycle; in the summer operating cycle, the functions of heat and humidity transfer and absorption are reversed.

Typically, these types of recovery units consist of:

- Aluminum rotor
- Galvanized steel sheet frame
- Constant speed electric gearmotor

Dimensions

Configurations A

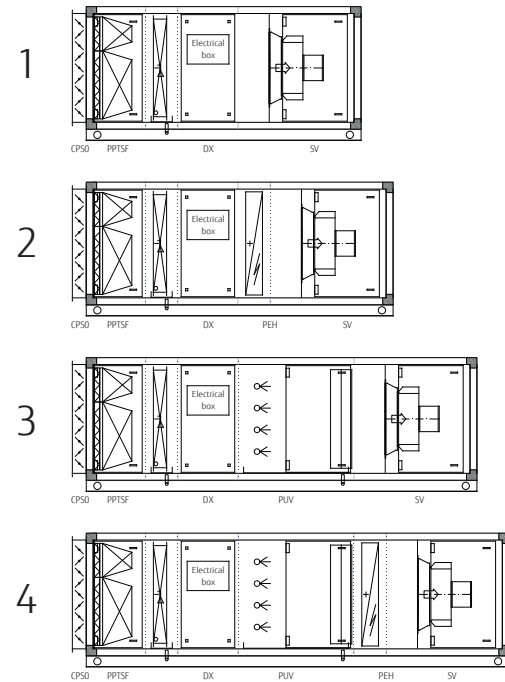

Model name	Config.	H (mm)	W (mm)	L (mm)	kg	L (with silencer) (mm)
AHHA025GWAA	1	1,064	1,154	2,619	611	3,529
AHHA025GWAB	2	1,064	1,154	3,109	679	4,019
AHHA025GWAC	3	1,064	1,154	2,619	629	3,529
AHHA025GWAD	4	1,064	1,154	3,109	697	4,019
AHHA040GWAA	1	1,199	1,354	2,749	844	3,659
AHHA040GWAB	2	1,199	1,354	3,319	931	4,229
AHHA040GWAC	3	1,199	1,354	2,749	865	3,659
AHHA040GWAD	4	1,199	1,354	3,319	952	4,229
AHHA048GWAA	1	1,309	1,574	2,749	921	3,659
AHHA048GWAB	2	1,309	1,574	3,319	1,023	4,229
AHHA048GWAC	3	1,309	1,574	2,749	944	3,659
AHHA048GWAD	4	1,309	1,574	3,319	1,046	4,229
AHHA080GWAA	1	1,544	2,074	3,189	1,542	4,099
AHHA080GWAB	2	1,544	2,074	3,839	1,701	4,749
AHHA080GWAC	3	1,544	2,074	3,189	1,570	4,099
AHHA080GWAD	4	1,544	2,074	3,839	1,729	4,749
AHHA096GWAA	1	1,789	2,250	3,189	1,691	4,099
AHHA096GWAB	2	1,789	2,250	3,839	1,869	4,749
AHHA096GWAC	3	1,789	2,250	3,189	1,724	4,099
AHHA096GWAD	4	1,789	2,250	3,839	1,899	4,749

Configurations B

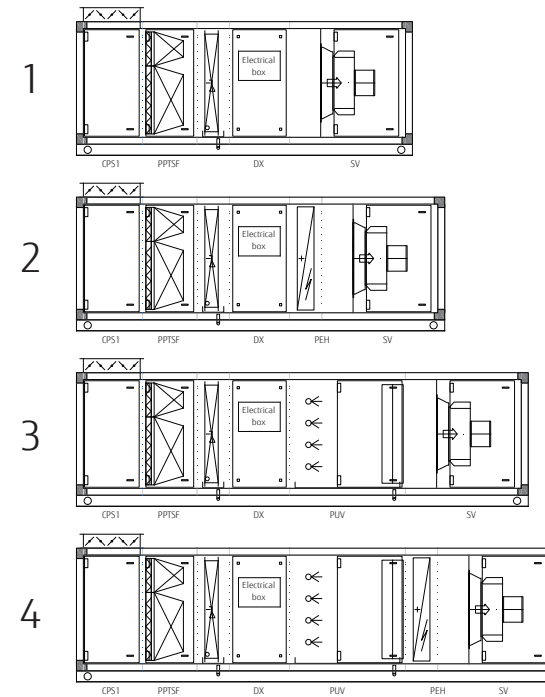

Model name	Config.	H (mm)	W (mm)	L (mm)	kg	L (with silencer) (mm)
AHHB025GWAA	1	1,179	1,154	2,854	628	3,764
AHHB025GWAB	2	1,179	1,154	3,344	696	4,254
AHHB025GWAC	3	1,179	1,154	2,854	646	3,764
AHHB025GWAD	4	1,179	1,154	3,344	714	4,254
AHHB040GWAA	1	1,314	1,354	3,084	873	3,994
AHHB040GWAB	2	1,314	1,354	3,654	960	4,564
AHHB040GWAC	3	1,314	1,354	3,084	894	3,994
AHHB040GWAD	4	1,314	1,354	3,654	981	4,564
AHHB048GWAA	1	1,424	1,574	3,084	953	3,994
AHHB048GWAB	2	1,424	1,574	3,654	1,055	4,564
AHHB048GWAC	3	1,424	1,574	3,084	976	3,994
AHHB048GWAD	4	1,424	1,574	3,654	1,078	4,564
AHHB080GWAA	1	1,659	2,074	3,624	1,591	4,534
AHHB080GWAB	2	1,659	2,074	4,274	1,749	5,184
AHHB080GWAC	3	1,659	2,074	3,624	1,619	4,534
AHHB080GWAD	4	1,659	2,074	4,274	1,777	5,184
AHHB096GWAA	1	1,904	2,250	3,724	1,760	4,634
AHHB096GWAB	2	1,904	2,250	4,374	1,936	5,284
AHHB096GWAC	3	1,904	2,250	3,724	1,790	4,634
AHHB096GWAD	4	1,904	2,250	4,374	1,966	5,284

Configurations C

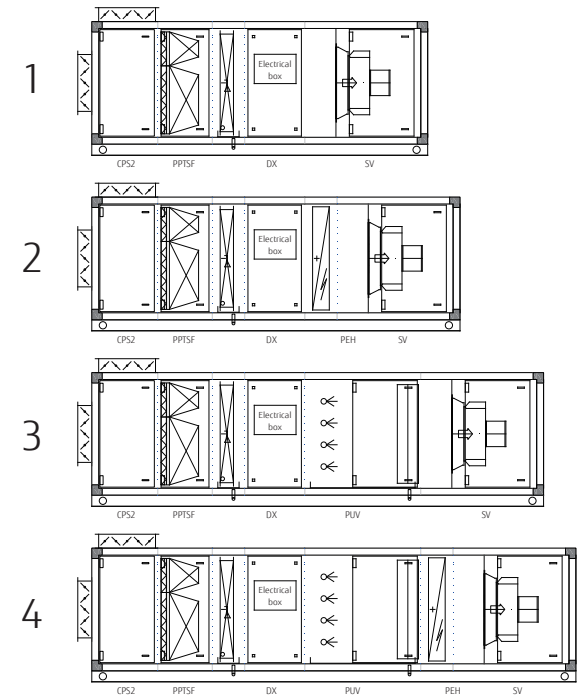

Model name	Config.	H (mm)	W (mm)	L (mm)	kg	L (with silencer) (mm)
AHHC025GWAA	1	1,179	1,154	2,969	650	3,879
AHHC025GWAB	2	1,179	1,154	3,459	718	4,369
AHHC025GWAC	3	1,179	1,154	2,969	668	3,879
AHHC025GWAD	4	1,179	1,154	3,459	736	4,369
AHHC040GWAA	1	1,314	1,354	3,199	899	4,109
AHHC040GWAB	2	1,314	1,354	3,769	986	4,679
AHHC040GWAC	3	1,314	1,354	3,199	920	4,109
AHHC040GWAD	4	1,314	1,354	3,769	1,007	4,679
AHHC048GWAA	1	1,424	1,574	3,199	980	4,109
AHHC048GWAB	2	1,424	1,574	3,769	1,082	4,679
AHHC048GWAC	3	1,424	1,574	3,199	1,003	4,109
AHHC048GWAD	4	1,424	1,574	3,769	1,105	4,679
AHHC080GWAA	1	1,659	2,074	3,739	1,624	4,649
AHHC080GWAB	2	1,659	2,074	4,389	1,782	5,299
AHHC080GWAC	3	1,659	2,074	3,739	1,652	4,649
AHHC080GWAD	4	1,659	2,074	4,389	1,810	5,299
AHHC096GWAA	1	1,904	2,250	3,839	1,799	4,749
AHHC096GWAB	2	1,904	2,250	4,489	1,975	5,399
AHHC096GWAC	3	1,904	2,250	3,839	1,829	4,749
AHHC096GWAD	4	1,904	2,250	4,489	2,005	5,399

Configurations D

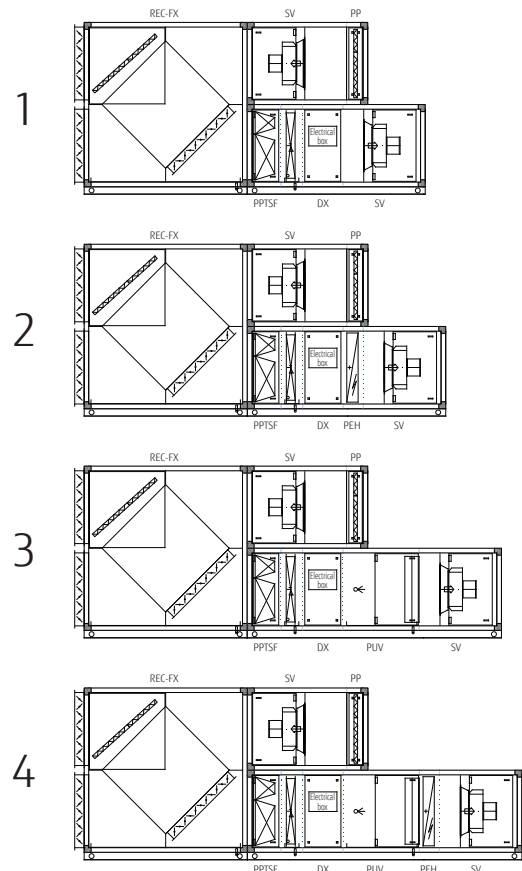

Model name	Config.	H (mm)	W (mm)	L (mm)	kg	L (with silencer) (mm)
AHHD025GWAA	1	2028/1064	1424/1154	4,311	1,259	5,221
AHHD025GWAB	2	2028/1064	1424/1154	4,801	1,327	5,711
AHHD025GWAC	3	2028/1064	1424/1154	4,311	1,277	5,221
AHHD025GWAD	4	2028/1064	1424/1154	4,801	1,345	5,711
AHHD040GWAA	1	2298/1199	1574/1354	4,871	1,750	5,781
AHHD040GWAB	2	2298/1199	1574/1354	5,441	1,837	6,351
AHHD040GWAC	3	2298/1199	1574/1354	4,871	1,771	5,781
AHHD040GWAD	4	2298/1199	1574/1354	5,441	1,858	6,351
AHHD048GWAA	1	2518/1309	1824/1574	4,871	1,978	5,781
AHHD048GWAB	2	2518/1309	1824/1574	5,348	2,080	6,258
AHHD048GWAC	3	2518/1309	1824/1574	4,778	2,001	5,688
AHHD048GWAD	4	2518/1309	1824/1574	5,348	2,103	6,258
AHHD080GWAA	1	2988/1544	2,074	6,161	3,361	7,071
AHHD080GWAB	2	2988/1544	2,074	6,811	3,520	7,721
AHHD080GWAC	3	2988/1544	2,074	6,161	3,389	7,071
AHHD080GWAD	4	2988/1544	2,074	6,811	3,548	7,721
AHHD096GWAA	1	3478/1789	2,250	6,451	3,849	7,361
AHHD096GWAB	2	3478/1789	2,250	7,008	4,025	7,918
AHHD096GWAC	3	3478/1789	2,250	6,451	3,879	7,268
AHHD096GWAD	4	3478/1789	2,250	7,008	4,055	7,918

Configurations E

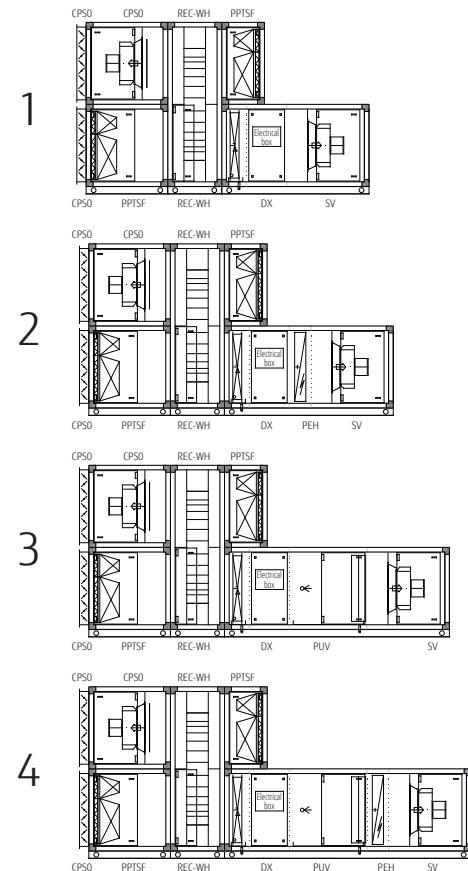

Model name	Config.	H (mm)	W (mm)	L (mm)	kg	L (with silencer) (mm)
AHHE025GWAA	1	2028/1064	1429/1154	3,813	1,150	4,723
AHHE025GWAB	2	2028/1064	1429/1154	4,303	1,226	5,213
AHHE025GWAC	3	2028/1064	1429/1154	3,813	1,168	4,723
AHHE025GWAD	4	2028/1064	1429/1154	4,303	1,244	5,213
AHHE040GWAA	1	2298/1199	1729/1354	4,073	1,571	4,983
AHHE040GWAB	2	2298/1199	1729/1354	4,643	1,658	5,553
AHHE040GWAC	3	2298/1199	1729/1354	4,073	1,592	4,983
AHHE040GWAD	4	2298/1199	1729/1354	4,643	1,679	5,553
AHHE048GWAA	1	2518/1309	1829/1574	4,073	1,696	4,983
AHHE048GWAB	2	2518/1309	1829/1574	4,643	1,798	5,553
AHHE048GWAC	3	2518/1309	1829/1574	4,073	1,719	4,983
AHHE048GWAD	4	2518/1309	1829/1574	4,643	1,821	5,553
AHHE080GWAA	1	2988/1544	2374/2074	4,953	2,753	5,863
AHHE080GWAB	2	2988/1544	2374/2074	5,603	2,912	6,513
AHHE080GWAC	3	2988/1544	2374/2074	4,953	2,781	5,863
AHHE080GWAD	4	2988/1544	2374/2074	5,603	2,940	6,513
AHHE096GWAA	1	3478/1789	2582/2250	4,953	3,035	5,863
AHHE096GWAB	2	3478/1789	2582/2250	5,603	3,211	6,513
AHHE096GWAC	3	3478/1789	2582/2250	4,953	3,065	5,863
AHHE096GWAD	4	3478/1789	2582/2250	5,603	3,241	6,513

Silencer PI

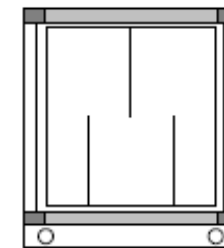

Connectable AHU model name	H (mm)	W (mm)	L (mm)	Kg
AHH* 025GWA*	1064	1154	910	209
AHH* 040GWA*	1199	1354	910	233
AHH* 048GWA*	1309	1574	910	274
AHH* 080GWA*	1544	2074	910	280
AHH* 096GWA*	1789	2250	910	444

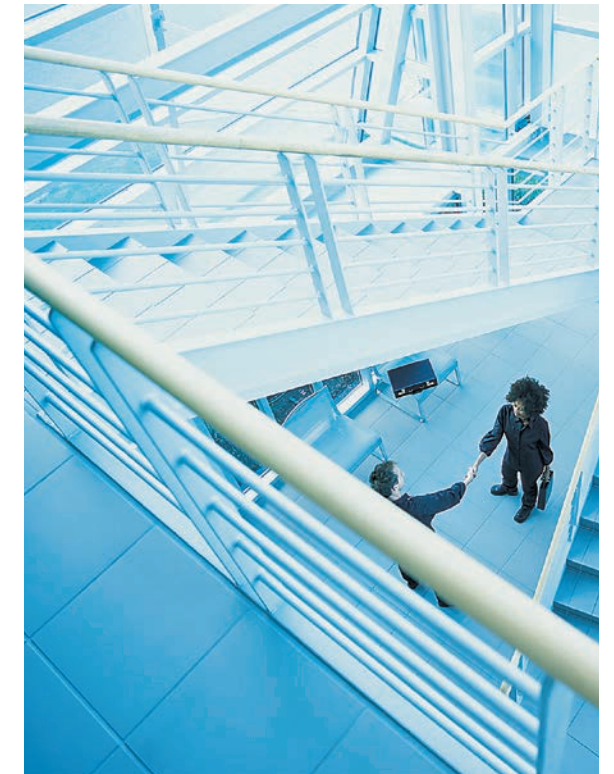

Loose Accessories

Galvanized metal sheet roof

Units that are installed outdoors or that are frequently exposed to the weather can be fitted with a hot galvanized steel roof (with a galvanization of 140 g/m² or higher) as an accessory element.

The roof overhang relative to the outer length of the unit is about 100 mm. All roof corners are equipped with protectors to prevent accidents.

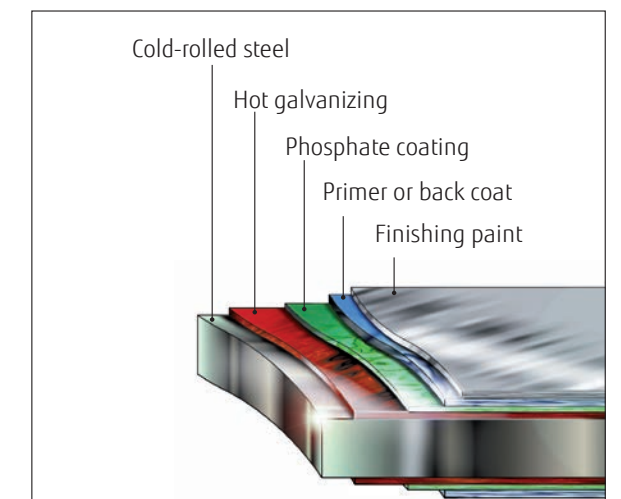

Total Pressure Drop Calculation

Air handling units (AHUs) controlled by EC inverter Plug Fans meet a high range of required airflows and static pressures.

The EC Inverter Plug-Fans allow the user to set various working conditions to meet the needs of the unit directly on site from the control panel on the Electrical Board section. If the wind is weaker than expected, for example, the operating conditions can be changed and adjusted with ease.

Selection procedure

- Select the most suitable AHU model according to the airflow rate.
- Based on the required airflow and overall static pressure value, identify the operating point of the airflow static pressure on the curve for the selected fan.

To calculate the overall static pressure value, refer to the component pressure drop table and add the net static pressure required for the plant.



Fan characteristic curves

Fan type 400 mm

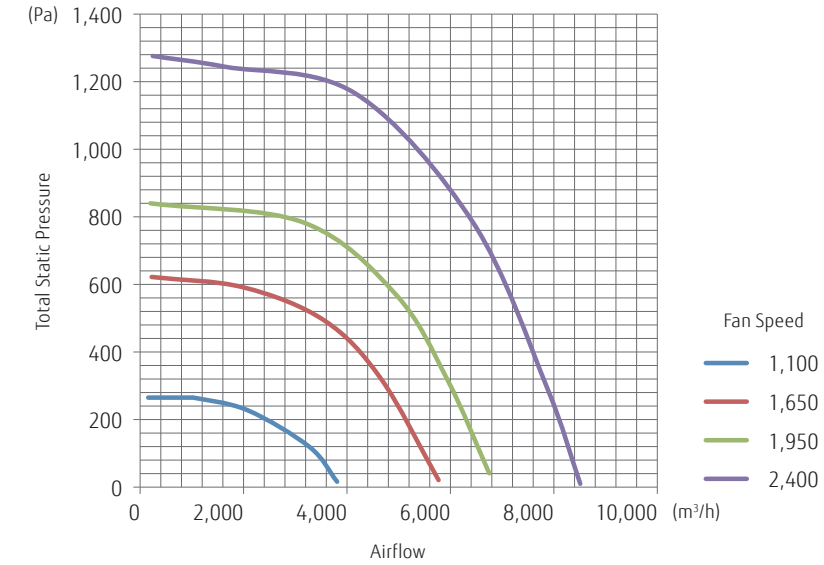

Component pressure drop table

ODU	AHU SIZE	MIN. NOM. MAX.	Airflow	Inlet damper (Config. A-E)	Inlet damper (Config. B-C)	COARSE 55% filters - supply	ePM1 50% filters	DX coil	Silencer	PHE + dampers + COARSE 55% filters - supply	PHE + damper - exhaust	COARSE 55% filters - exhaust (Config. D)	Heat wheel - supply	COARSE 55% filters - supply (Config. E)	ePM1 50% filters (Config. E)	Heat wheel - exhaust	COARSE 55% filters - exhaust (Config. E)	Exhaust damper (Config. E)	Humidifier	Electrical heater
			m³/h	Pa	Pa	Pa	Pa	Pa	Pa	Pa	Pa	Pa	Pa	Pa	Pa	Pa	Pa	Pa	Pa	Pa
10HP	025	MIN.	4,300	1	12	91	156	55	26	206	120	91	162	93	144	159	84	7	-	-
		NOM.	4,500	1	13	98	158	59	28	210	122	95	167	93	146	165	95	8	-	-
		MAX.	5,000	2	16	99	164	71	36	235	147	96	187	95	150	185	96	10	-	-
14 HP	040	MIN.	5,000	1	4	91	138	37	4	154	70	91	116	89	135	114	91	4	-	-
		NOM.	7,200	2	13	87	149	68	10	240	145	87	172	93	144	169	94	8	-	-
		MAX.	8,000	2	16	96	153	82	12	243	165	96	193	94	147	190	96	9	-	-
18 HP	048	MIN.	8,100	1	12	96	153	50	10	225	139	92	167	94	147	165	92	9	-	-
		NOM.	8,600	1	13	97	156	55	11	241	155	93	178	95	149	176	93	10	-	-
		MAX.	9,100	2	15	98	159	60	13	257	171	93	189	95	152	187	93	11	-	-
2X 14 HP	080	MIN.	11,000	1	8	91	140	30	9	148	62	90	121	90	137	119	90	6	-	-
		NOM.	14,500	2	14	94	148	47	16	188	101	93	163	93	143	161	93	10	-	-
		MAX.	16,100	2	17	96	153	56	19	209	122	94	183	94	147	180	94	13	-	-
2X 18 HP	096	MIN.	16,000	1	10	96	152	37	16	157	74	91	146	92	142	144	91	10	-	-
		NOM.	17,300	1	11	97	156	42	19	168	86	92	159	93	145	157	92	11	-	-
		MAX.	18,100	1	13	98	158	46	21	175	93	92	167	93	146	165	92	13	-	-

Air flow Rate	Total static pressure	Input power	Fan speed (n)	LwAin	LwAout
m³/h	Pa	W	rpm	dB	dB
156	265	124	1100	63	71
334	265	134	1100	63	70
1002	265	187	1100	62	69
1025	265	181	1100	62	69
2072	228	234	1100	58	66
3275	119	224	1100	62	69
3809	16	173	1100	69	74
223	622	352	1650	75	82
2005	591	642	1650	72	79
3564	493	767	1650	68	75
4656	321	708	1650	71	77
5770	21	487	1650	79	83
200	840	509	1950	79	86
3163	783	1154	1950	74	81
4946	570	1223	1950	74	80
5948	316	1027	1950	78	83
6750	41	773	1950	83	87
245	1276	921	2400	85	92
1649	1244	1497	2400	86	92
4163	1165	2223	2400	81	87
6438	783	2237	2400	81	87
7864	296	1738	2400	86	91
8510	10	1389	2392	89	93

Fan type 560 mm

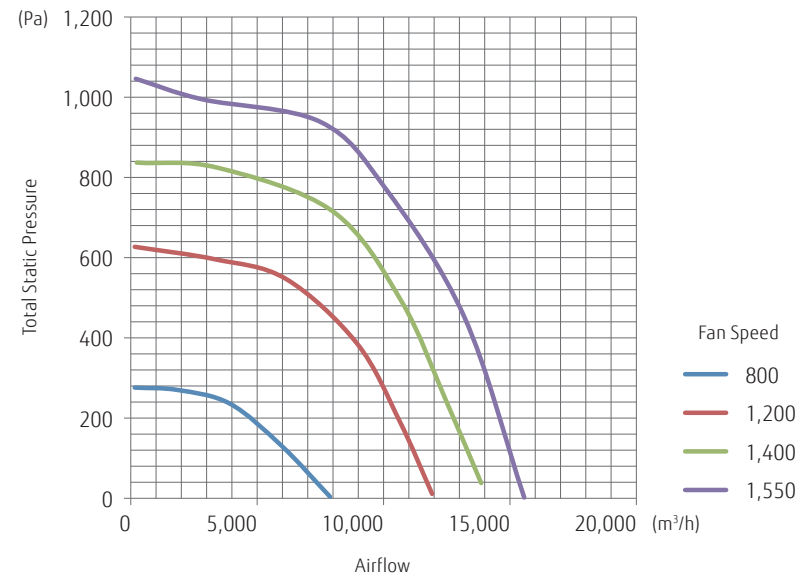

Air flow Rate	Total static pressure	Input power	Fan speed (n)	LwAin	LwAout
m³/h	Pa	W	rpm	dB	dB
158	276	209	800	65	72
1861	270	345	800	65	71
3921	236	438	800	61	67
5980	130	452	800	62	67
7881	4	313	800	69	74
158	627	591	1200	77	83
3327	596	1164	1200	75	82
6139	547	1471	1200	71	77
8950	386	1473	1200	72	78
10653	190	1212	1200	76	82
11921	11	936	1200	80	85
238	837	901	1400	80	87
3446	824	1743	1400	80	87
8000	715	2403	1400	75	81
10693	493	2260	1400	76	82
12475	243	1859	1400	80	86
13861	38	1521	1400	85	89
198	1046	1210	1550	84	90
2812	995	2086	1550	84	91
7485	939	3131	1550	78	84
10059	774	3249	1550	77	84
13188	453	2901	1550	82	88
15564	2	1948	1550	91	94

Fan type 710 mm

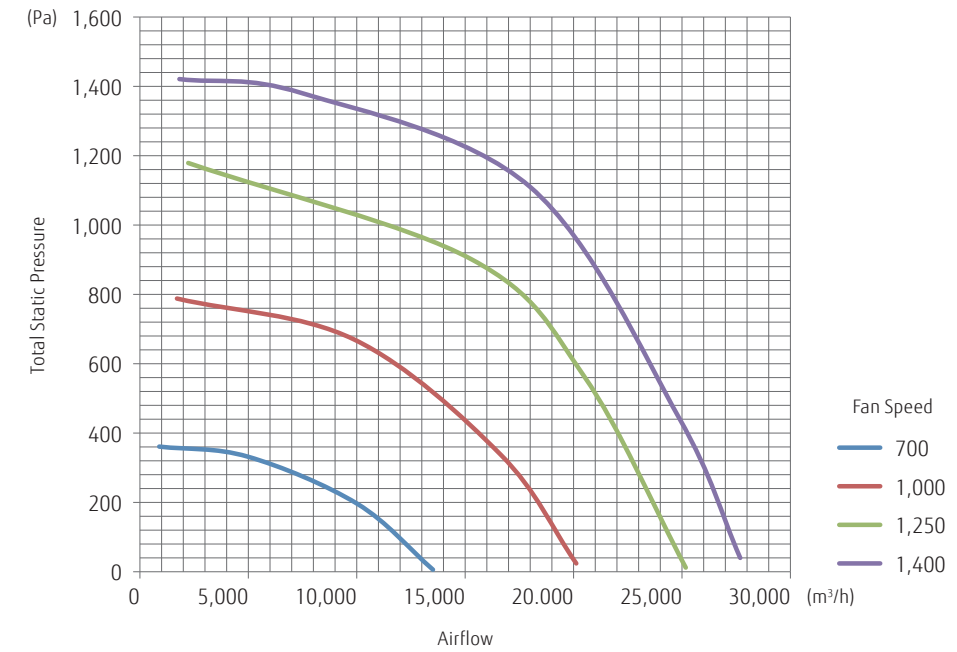

Air flow Rate	Total static pressure	Input power	Fan speed (n)	LwAin	LwAout
m³/h	Pa	W	rpm	dB	dB
891	361	744	700	71	77
4975	332	1290	700	69	74
10025	196	1427	700	69	75
13515	6	880	700	77	83
1708	788	1693	1000	81	88
9876	670	3179	1000	77	83
16634	338	3084	1000	80	86
20124	24	2177	1000	87	93
2228	1179	3015	1250	87	94
15297	901	6054	1250	83	89
20495	563	5794	1250	86	92
25173	12	3857	1250	92	98
1821	1421	3716	1400	89	96
7500	1380	5851	1400	89	95
17996	1110	8301	1400	86	92
24855	445	6916	1400	91	98
27685	40	5271	1400	95	101

Specifications

Configuration A-B-C

Model FG	025	040	048	080	096	
Model name	AHHA025GWA* AHHB025GWA* AHHC025GWA*	AHHA040GWA* AHHB040GWA* AHHC040GWA*	AHHA048GWA* AHHB048GWA* AHHC048GWA*	AHHA080GWA* AHHB080GWA* AHHC080GWA*	AHHA096GWA* AHHB096GWA* AHHC096GWA*	
Casing						
Material	Outer skin: 0.6 mm thick pre-painted galvanized sheet; Inner skin: 0.6 mm thick galvanized sheet					
Insulation	Polyurethane foam, 50 mm thick, 45 kg/m ³					
Performance						
Cooling capacity	kW	25	40	48	78	96
Heating capacity	kW	31.5	45	50	81.5	100
Available static pressure	Pa	200	200	200	200	200
Power supply	V/Ph/Hz	400/3/50	400/3/50	400/3/50	400/3/50	400/3/50
Airflow						
Max.	m ³ /h	5000	8000	9100	16100	18100
Rated	m ³ /h	4500	7200	8600	14500	17300
Min.	m ³ /h	4300	5000	8100	11000	16000
Cross-flow heat recovery						
Efficiency (*)	%	—	—	—	—	—
DX Coil						
Rows	n°	4				
Coil type		25 × 22 - 3/8"				
Coil duty		Cooling/Heating				
Fluid		R410A				
Pipe material		Copper				
Fin material		Aluminum				
Electrical heating						
Stages	n°	3				
Heating capacity	kW	9	15	18	30	36
Humidifier						
Fix steam capacity	kg/h	15	25	30	45	60
Fan						
Type		EC inverter Plug Fan				
Motor data	mm	400	560	560	710	710
	kW	2.4	3.4	3.4	7.3	7.3
Thermal transmittance of casing (TT) class						
Thermal bridging factor (TBF) class		T3	T3	T3	T3	T3
Casing strength (CS) class		D2 (M)	D2 (M)	D2 (M)	D2 (M)	D2 (M)
Casing air leakage (CAL) class@-400Pa		L2 (M)	L2 (M)	L2 (M)	L2 (M)	L2 (M)
Casing air leakage (CAL) class@+700 Pa		> L3 (M)	> L3 (M)	> L3 (M)	> L3 (M)	> L3 (M)
Filter bypass leakage (FBL) class		F9 (M)	F9 (M)	F9 (M)	F9 (M)	F9 (M)

(*) at rated airflow

Configuration D

Model FG	025	040	048	080	096	
Model name	AHHD025GWA*	AHHD040GWA*	AHHD048GWA*	AHHD080GWA*	AHHD096GWA*	
Casing						
Material	Outer skin: 0.6 mm thick pre-painted galvanized sheet; Inner skin: 0.6 mm thick galvanized sheet					
Insulation	Polyurethane foam, 50 mm thick, 45 kg/m ³					
Performance						
Cooling capacity	kW	25	40	48	78	96
Heating capacity	kW	31.5	45	50	81.5	100
Available static pressure	Pa	200	200	200	200	200
Power supply	V/Ph/Hz	400/3/50	400/3/50	400/3/50	400/3/50	400/3/50
Airflow						
Max.	m ³ /h	5000	8000	9100	16100	18100
Rated	m ³ /h	4500	7200	8600	14500	17300
Min.	m ³ /h	4300	5000	8100	11000	16000
Heat recovery						
Efficiency (*)	%	73.3	74.4	74.2	73.7	73.6
DX Coil						
Rows	n°	4				
Coil type		25 × 22 - 3/8"				
Coil duty		Cooling/Heating				
Fluid		R410A				
Pipe material		Copper				
Fin material		Aluminum				
Electrical heating						
Stages	n°	3				
Heating capacity	kW	9	15	18	30	36
Humidifier						
Fix steam capacity	kg/h	15	25	30	45	60
Fan						
Type		EC inverter Plug Fan				
Motor data	mm	400	560	560	710	710
	kW	2.4	3.4	3.4	7.3	7.3
Thermal transmittance of casing (TT) class						
Thermal bridging factor (TBF) class		T3	T3	T3	T3	T3
Casing strength (CS) class		D2 (M)	D2 (M)	D2 (M)	D2 (M)	D2 (M)
Casing air leakage (CAL) class@-400Pa		L2 (M)	L2 (M)	L2 (M)	L2 (M)	L2 (M)
Casing air leakage (CAL) class@+700 Pa		> L3 (M)	> L3 (M)	> L3 (M)	> L3 (M)	> L3 (M)
Filter bypass leakage (FBL) class		F9 (M)	F9 (M)	F9 (M)	F9 (M)	F9 (M)

(*) at rated airflow

Configuration E

Model FG	025	040	048	080	096	
Model name	AHHE025GWA*	AHHE040GWA*	AHHE048GWA*	AHHE080GWA*	AHHE096GWA*	
Casing						
Material	Outer skin: 0.6 mm thick pre-painted galvanized sheet; Inner skin: 0.6 mm thick galvanized sheet					
Insulation	Polyurethane foam, 50 mm thick, 45 kg/m ³					
Performance						
Cooling capacity	kW	25	40	48	78	96
Heating capacity	kW	31.5	45	50	81.5	100
Available static pressure	Pa	200	200	200	200	200
Power supply	V/Ph/Hz	400/3/50	400/3/50	400/3/50	400/3/50	400/3/50
Airflow						
Max.	m ³ /h	5000	8000	9100	16100	18100
Rated	m ³ /h	4500	7200	8600	14500	17300
Min.	m ³ /h	4300	5000	8100	11000	16000
Heat recovery						
Efficiency (*)	%	75.6	74.7	74.2	75.3	75.6
DX Coil						
Rows	n°	4				
Coil type		25 × 22 - 3/8"				
Coil duty		Cooling/Heating				
Fluid		R410A				
Pipe material		Copper				
Fin material		Aluminum				
Electrical heating						
Stages	n°	3				
Heating capacity	kW	9	15	18	30	36
Humidifier						
Fix steam capacity	kg/h	15	25	30	45	60
Fan						
Type		EC inverter Plug Fan				
Motor data	mm	400	560	560	710	710
	kW	2.4	3.4	3.4	7.3	7.3
Thermal transmittance of casing (TT) class						
Thermal bridging factor (TBF) class		T3	T3	T3	T3	T3
Casing strength (CS) class		D2 (M)	D2 (M)	D2 (M)	D2 (M)	D2 (M)
Casing air leakage (CAL) class@-400Pa		L2 (M)	L2 (M)	L2 (M)	L2 (M)	L2 (M)
Casing air leakage (CAL) class@+700 Pa		> L3 (M)	> L3 (M)	> L3 (M)	> L3 (M)	> L3 (M)
Filter bypass leakage (FBL) class		F9 (M)	F9 (M)	F9 (M)	F9 (M)	F9 (M)

(*) at rated airflow

Control system

AHU units include a built-in electrical panel and expansion valve with control PCB. Setpoint is fixed via standard wired control. The cooling load is determined by the air return temperature and the setpoint of the wired control.

AHU Controller

UTY-TXUX



Features

- Easy to install. Control connects to AHU PLC.
- Controls can be installed after the building is decorated.
- Mode lock function: Allows users to lock the operating mode of the AHU.

Easy operation

This remote controller provides an intuitive user interface with a touch screen display.

Functions

- Schedule setting change
- Set temperature and humidity
- Ambient name
- Alarm setting
- Event setting

Specifications

Model name		UTY-TXUX
Format	mm	120 × 86 × 25
Screen resolution		Display touch color 3.5" 320 × 240
Power supply		24 V AC - 24 V AC/DC
Analogue inputs		1 × Integrated NTC
Connectivity		RS485 - MODBUS® SL, USB Micro-B (debug and programming)
Operating temperature		0 - +50 °C

System controller

UTY-APGXZ1 Software

Features

System controller enables advanced integrated monitoring and control of VRF network systems operating in small to large buildings.

- System controller controls up to 4 VRF network systems, 1,600 indoor units, and 400 outdoor units.
- To accommodate facility management needs, the system controller offers—in addition to precise air conditioning control—remote central control, electricity charge apportionment, schedule management, and energy-saving options for VRF network systems.

Max. Controllable
4 VRF network systems

Max. Controllable
400 outdoor units

Max. Controllable
1,600 indoor units

System controller Lite

UTY-ALGXZ1 + UTY-PLGXX2 Software

Features

System controller Lite offers a set of standard functions to manage air conditioners operating in a small or midsize building.

- System controller Lite controls up to 1 VRF network system, 400 indoor units, and 100 outdoor units.
- In addition to precise air conditioning control, a variety of management-specific applications are available as options, enabling a wider range of control.

Max. Controllable
1 VRF network systems

Max. Controllable
100 outdoor units

Max. Controllable
400 indoor units



Centralized control is also possible to stop the operation of not only air conditioners, but also lighting and ventilation equipment. These features are useful for managing the energy efficiency of the entire building.



Summary of functions

Function	Type	System controller		System controller Lite				
		UTY-APGXZ1	Option UTY-PEGXZ1	UTY-ALGXZ1	Option UTY-PLGXR2	Option UTY-PLGXA2	Option UTY-PLGXE2	Option UTY-PLGXX2
System specification	Max. number of VRF networks supported	4	—	1	—	—	—	—
	Max. number of indoor unit and remote controller groups per VRF network	400	—	400	—	—	—	—
	Max. number of outdoor units per VRF network	100	—	100	—	—	—	—
	Max. number of indoor units and remote controller groups per system controller	1600	—	400	—	—	—	—
	Max. number of outdoor units per system controller	400	—	100	—	—	—	—
Site supervision	Multiple site display	10	—	10	—	—	—	—
	Number of buildings per site	20	—	—	—	—	—	—
	Number of floors per site	200	—	—	—	—	—	—
	Number of floors per building	50	—	—	—	—	—	—
	3D graphical layout view	●	—	—	—	—	—	—
	2D graphical layout view	●	—	—	—	—	—	—
	List display	●	—	●	—	—	—	—
	Tree display	●	—	●	—	—	—	—
Error management	Group display	●	—	●	—	—	—	—
	Error notification	●	—	●	—	—	—	—
	Audible alarm	●	—	●	—	—	—	—
History	E-mail notification of errors	●	—	●	—	—	—	—
	Error history	●	—	●	—	—	—	—
	Operation history	●	—	●	—	—	—	—
Operation control	Individual control	Control history	●	—	●	—	—	—
		On/Off	●	—	●	—	—	—
		Operation mode*	●	—	●	—	—	—
		Room temperature	●	—	●	—	—	—
		Fan speed	●	—	●	—	—	—
		Airflow direction	●	—	●	—	—	—
		Economy mode	●	—	●	—	—	—
		Setting temperature range limitation	●	—	●	—	—	—
	Individual management	Anti-freeze	●	—	●	—	—	—
		Low noise setting of outdoor units	●	—	●	—	—	—
		Setting remote control prohibition	●	—	●	—	—	—
	Other	Setting temperature range limitation	●	—	●	—	—	—
		Filter sign reset	●	—	●	—	—	—
	Schedule	Memory operations	●	—	●	—	—	—
		Pattern operations	●	—	●	—	—	—
Annual Schedule		●	—	●	—	—	—	
Setting for a specific date		●	—	●	—	—	—	
On/Off per day		72	—	72	—	—	—	
On/Off per week		504	—	504	—	—	—	
Day off		●	—	●	—	—	—	
Remote management	Minimum unit of timer setting (minutes)	10	—	10	—	—	—	
	Weekly schedule for low noise mode	●	—	●	—	—	—	
	Web operation	●	—	●	—	—	—	
	Remote monitoring	●	—	—	●	—	—	
Electricity charge apportionment	Remote operation control	●	—	●	—	—	—	
	Remote function setting	●	—	—	●	—	—	
	Apportionment charge/bill calculation	●	—	—	●	—	—	
	Tenant (block) setting	●	—	—	●	—	—	
	Common facilities apportionment setting	●	—	—	●	—	—	
Energy saving management	Rated power consumption allotment setting	●	—	—	●	—	—	
	Individual calculations for cooling and heating	—	●	—	—	●	—	
	Electricity meter supported	—	●	—	—	●	—	
	Indoor unit rotation	—	●	—	—	—	●	
	Peak cut control	—	●	—	—	—	●	
Control of external devices	Capacity saving for outdoor unit	—	●	—	—	—	●	
	Record of energy saving operation	—	●	—	—	—	●	
	Information on energy saving	—	●	—	—	—	●	
	Power consumption monitor	—	●	—	—	—	●	
Others	Electricity meter supported	—	●	—	—	—	●	
	Monitor	●	—	—	—	—	●	
	Control	●	—	—	—	—	●	
	Importing and exporting databases	●	—	●	—	—	—	
Others	Automatic clock adjustment	●	—	●	—	—	—	
	Multiple language support	7 languages	—	7 languages	—	—	—	
	Refrigerant leak detection function	●	—	●	—	—	—	
	Power shutdown	●	—	●	—	—	—	

●: Available. - : Not available.

Computer requirements

The specifications required for the Computer are shown in the table below:

	System controller	System controller Lite
Operating system	<ul style="list-style-type: none"> Microsoft® Windows® 7 Home Premium (32-bit or 64-bit) SP1, Windows® 7 Professional (32-bit or 64-bit) SP1 Microsoft® Windows® 8.1 (32-bit or 64-bit), Windows® 8.1 Pro (32-bit or 64-bit) Microsoft® Windows® 10 Home (32-bit or 64-bit), Windows® 10 Pro (32-bit or 64-bit) Supported languages: English, Chinese, French, German, Russian, Spanish, and Polish	
CPU	Intel® Core™ i3 2 GHz or higher	
Memory	<ul style="list-style-type: none"> 2 GB or more (for Windows® 7 [32-bit]) 4 GB or more (for Windows® 7 [64-bit], Windows® 8.1, and Windows® 10) 	
HDD	40 GB or more of free space	
Screen resolution	1024 × 768 or higher	
Interface	<ul style="list-style-type: none"> Ethernet port (for getting access to the internet using LAN) or a modem (for getting access to the internet using a landline) Up to 6 USB ports (Only required for a server Computer working as a VRF controller) -Maximum of 2 USB ports are required to connect to a White-USB-key/ WibuKey -Up to 4 USB ports required to connect to a Echelon® U10 USB network interface * Maximum number of required USB ports depends on the applicable system configuration. 	<ul style="list-style-type: none"> Ethernet port (for getting access to the internet using LAN) or a modem (for getting access to the internet using a landline) Up to 6 USB ports (Only required for a server Computer working as a VRF controller) -Maximum of 4 USB ports are required to connect to a White-USB-key/ WibuKey -1 USB port is required for an Echelon® U10 USB Network Interface * The maximum number of required USB ports depends on the applicable system configuration.
Graphic accelerator	Microsoft® DirectX® 9.0c compatible	
Software	Adobe® Acrobat Reader® 9.0 or later	

* Echelon® U10 USB Network Interface - TP/FT-10 Channel (Model name: 75010R) (Required for each VRF Network)

Packing List

Type	For System controller		For System controller Lite				
	System controller	Option Energy manager	System controller Lite	Remote access	Option Electricity charge apportionment	Option Energy saving	Option Central Control
Model name	UTY-APGXZ1	UTY-PEGXZ1	UTY-ALGXZ1	UTY-PLGXR2	UTY-PLGXA2	UTY-PLGXE2	UTY-PLGXX2
White-USB-key	1	1	1	1	1	1	1

*1: Software protection key to be inserted in a USB slot running System controller or System controller Lite. System controller or System controller Lite may only run on a Computer with a White-USB-key. However, a White-USB-key is not required for remote VRF Explorer software.

Light Commercial & Commercial, Residential

CONTROL SYSTEM & OPTIONAL PARTS

- C-002 Control System Overview
- C-006 Best Control Solution for Each Building Structure
- C-008 Comparison Table of Controllers
- C-048 Control System List
- C-056 Optional Parts Overview
- C-062 Optional Parts List
- C-066 Function List

A wide product lineup to meet a variety of needs

We can flexibly meet customer needs through a variety of offerings including wired and wireless individual remote controllers, central remote controllers that simultaneously control multiple indoor units, and a variety of converters that link with other systems.

CONTROL SYSTEM

INDIVIDUAL CONTROL

- C-010 Wired Remote Controller (with touch panel)
- C-012 Wired Remote Controller / Compact Wired Remote Controller
- C-013 Wired Remote Controller
- C-014 Simple Remote Controller
- C-015 Wireless Remote Controller
- C-016 IR Receiver Unit

CONVERTERS/ADAPTERS

- C-018 WLAN Adapter
- C-022 Multi-split Protocol WLAN Adapter

CENTRALIZED CONTROL





- C-023 Home Central Remote Controller
- C-024 Central Remote Controller
- C-026 Touch Panel Controller
- C-030 System Controller Software / System controller Lite Software

CONVERTERS/ADAPTERS

- C-034 MODBUS® Converter for Indoor unit
- C-035 MODBUS® Interface
- C-036 MODBUS® Converter for VRF
- C-037 BACnet® interface
- C-038 BACnet® Gateway Software
- C-039 BACnet® Gateway Hardware
- C-040 BACnet®/MODBUS® Router
- C-041 BACnet®/MODBUS® Cloud Device
- C-042 KNX® converter for Indoor unit / KNX® converter for VRF
- C-043 KNX® Interface
- C-044 Network Converter for Single-Split Type
- C-045 Network Converter for LONWORKS™
- C-046 External switch controller / Signal Amplifier

Optional parts

- C-058 Silver Ion Filter
- C-059 Auto Louver Grille Kit
- C-060 Pressure Sensor Kit
- C-061 External Power Supply Unit
AIR BEAM Radiation air outlet unit
- C-070 Separation Tube and other piping products

-  SPLIT
-  MULTI-SPLIT
-  VRF J Series
-  VRF V Series

Control System Overview

for Split & Multi-split

All indoor units* are equipped with a wireless or wired remote controller as standard. Additional options are available, such as individual remote controllers and central remote controllers. The easy-to-operate central remote controller makes it simple to control the operation mode, temperature, airflow volume, timer, and other functions of each indoor unit from a single location.

* Except for some products



Air Conditioning Individual control



Wired remote controller
A built-in thermo sensor monitors and controls room temperature accurately.



Wireless remote controller
Simple and versatile operations with a choice of 4 different types of timers



Simple remote controller
Compact remote controller with basic functionality

For Ceiling type



For Duct type

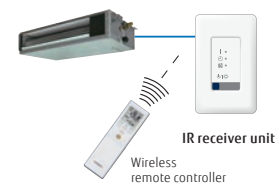

For Cassette type



IR receiver unit
This IR receiver unit enables a wireless remote controller to control a duct-type indoor unit.

Air Conditioning Centralized control



Home central remote controller for 5 & 6-unit Multi-split type
Enables individual and central control.

Converters/Adapters

For external control via BMS/Home Automation Systems

MODBUS® converter for indoor units
UTY-VMSX



MODBUS® interface for indoor units



KNX® converter for indoor units
UTY-VK SX



KNX® interface for indoor units



WLAN adapter



Network converter

DC power supply type
UTY-VTGX



AC power supply type
UTY-VTGXV



Online Control (Wireless Control via Smartphone/Tablet)

With the WLAN adapter and the AIRSTAGE Mobile app, you can control the heating and cooling of your home anytime, anywhere.

WLAN adapter

The dedicated WLAN adapter enables the air conditioner to be operated by smartphone or tablet computer.



AIRSTAGE Mobile

Download Free
Available on the App Store and Google play

Simple, user-friendly interface design

The designed screen display makes it easier than ever to operate.

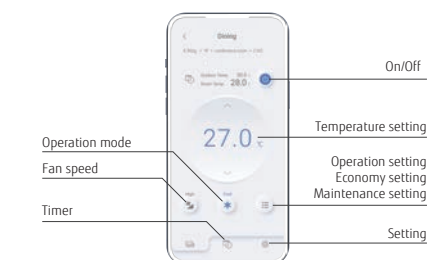

Control System Overview

for VRF

To meet the diverse needs of customers, we offer a variety of control options for our VRF systems, such as individual control, centralized control, and building management system (BMS) options.

Air Conditioning Individual control



Wired remote controller (with touch pane)
UTY-RNRGZ5



Wired remote controller
UTY-RLRG



Compact wired remote controller
UTY-RCRGZ1



Simple remote controller
UTY-RSRG
UTY-RHRG
Without operation mode



Wireless Remote Controller
UTY-LNHG



For Duct type
For One-way flow cassette Series/3D-flow cassette Series/duct type

IR receiver unit

UTB-YWC for duct type
UTY-TRHX for One-way flow cassette Series/3D flow cassette Series/duct type



for Circular flow cassette Series

UTY-LBHDX for Circular flow cassette Series

Air Conditioning Centralized control

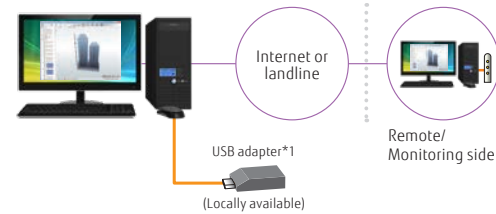

System controller (Software)
UTY-APGXZ1/UTY-ALGXZ1 (Lite version)
Up to 1600^{*2} Indoor units

*1: Echelon® U10 USB Network Interface
*2: The Lite version controls up to 400 indoor units.

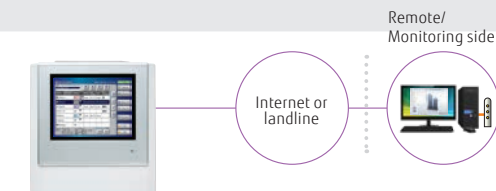

Touch panel controller
UTY-DTGGZ1
Up to 400 Indoor units



Central remote controller
UTY-DCGGZ2
Up to 100 Indoor units

Converters/Adapters

For external control via BMS/Home Automation Systems

BACnet® gateway
UTY-ABGXZ1 **Software**



VTY-VBGX Hardware



BACnet® interface for Indoor units
FG-IR-BMG1Z1



Network converter (For LonWorks™)
UTY-VLGX



MODBUS® converter for Indoor units
UTY-VMSX



for VRF
UTY-VMGX



KNX® converter for Indoor units
UTY-VKSX



for VRF
UTY-VKGX



WLAN adapter
UTY-TFSXJ3 / UTY-TFSXZ1



External switch controller
UTY-TERX



BMS/BAS^{*3}



BMS^{*3}, Home automation system



*3: BMS/BAS: Building Management System/Building Automation System

Converters/Adapters for system expansion

Network converter DC power supply type
UTY-VTGX



Network converter AC power supply type
UTY-VTGXV



Signal amplifier
UTY-VSGXZ1



Card-key (Locally available)

Internet device

Best control solution for each building structure

Fujitsu General provides the best control solutions suitable for various building structures.

SHOP

Type	Individual control			Centralized control			Integrating control (Interface)				
	Wired remote controller	Central remote controller	Touch panel controller	System controller	Network converter for LONWORKS™	MODBUS® Converter	KNX® converter				
	UTY-RNRGZ5 UTY-RLRG UTY-RVNGM UTY-RCRGZ1	UTY-DCGGZ2	UTY-DTGGZ1	UTY-APGXZ1 UTY-ALGXZ1	UTY-VLGX	UTY-VMGX	UTY-VKGX				
Automatic control of air conditioning (Schedule timer, Weekly timer, etc.)	•	•	•	•							
Controls limited to staff: Remote controller prohibition, Setting temperature range limitation, etc.		•	•	•	•	•	•				•
Group control		•	•	•							
Advanced energy saving: Peak cut, Operation of indoor unit rotation, etc.				•							
Remote monitoring management		•	•	•							
Manage multiple sites		•	•	•							
Monitor energy consumption				•							
Control third-party products				•							
Integrate Fujitsu General air conditioning into BMS					•	•	•				

HOTEL

Type	Individual control			Centralized control			Integrating control (Interface)				
	Wired remote controller	Simple remote controller	Wireless remote controller	Central remote controller	Touch panel controller	System controller	BACnet® gateway	Network converter for LONWORKS™	MODBUS® converter	KNX® converter	External switch controller
	UTY-RNRGZ5 UTY-RLRG UTY-RCRGZ1	UTY-RSRG UTY-RHRG UTY-RSNGM	UTY-LNHG UTY-LNTG	UTY-DCGGZ2	UTY-DTGGZ1	UTY-APGXZ1 UTY-ALGXZ1	UTY-ABGXZ1 UTY-VBGX	UTY-VLGX	UTY-VMGX	UTY-VKGX	UTY-TERX
Local control for hotel guests	•	•	•								
Centralized air conditioning control for common areas				•	•	•	•	•	•	•	
Limited control for hotel guests				•	•	•	•	•	•	•	
Remote monitoring management				•	•	•					
Advanced energy saving: Peak cut, Operation of indoor unit rotation, etc.						•	•				
Monitor energy consumption						•					
Control third-party products						•					
Integrate Fujitsu General air conditioning into BMS							•	•	•	•	
Interlock with window contact											•
Interlock with key card											•

OFFICE

Type	Individual control			Centralized control			Integrating control (Interface)				
	Wired remote controller	Simple remote controller	Wireless remote controller	Central remote controller	Touch panel controller	System controller	BACnet® gateway	Network converter for LONWORKS™	MODBUS® converter	KNX® converter	External switch controller
	UTY-RNRGZ5 UTY-RLRG UTY-RCRGZ1	UTY-RSRG UTY-RHRG UTY-RSNGM	UTY-LNHG UTY-LNTG	UTY-DCGGZ2	UTY-DTGGZ1	UTY-APGXZ1 UTY-ALGXZ1	UTY-ABGXZ1 UTY-VBGX	UTY-VLGX	UTY-VMGX	UTY-VKGX	UTY-TERX
Local control for office staff	•	•	•	•							
Automatic control of air conditioning (Schedule timer, Weekly timer, etc.)	•		•	•	•	•	•				
Centralized air conditioning control for management				•	•	•	•	•	•	•	
Controls limited to staff: Remote controller prohibition, Setting temperature range limitation, etc.				•	•	•	•	•	•	•	
Advanced energy saving: Peak cut, Operation of indoor unit rotation, etc.						•	•				
Remote monitoring management				•	•	•					
Electricity charge apportionment					•	•	•				
Monitor energy consumption						•					
Control third-party products						•					
Integrate Fujitsu General air conditioning into BMS							•	•	•	•	
Interlock with door contact											•
Interlock with Occupancy sensor for meeting room				•							•

Comparison table of controllers

Item																
Model name	UTY-RNRGZ5	UTY-RLRG	UTY-RVNGM	UTY-RCRGZ1	UTY-RSNGM	UTY-RSRG		UTY-RHRG	UTY-LNHG	UTY-LNTG	UTY-DMMGM	UTY-DCGGZ2	UTY-DTGGZ1	UTY-ALGXZ1	UTY-APGXZ1	
Maximum number of controllable remote controller groups	1	1	1	1	1	1		1	1	1	1	100	400	400	1600	
Maximum number of controllable indoor units	16	16	16	1	16	16		16	16	16	8	100	400	400	1600	
Maximum number of controllable groups	-	-	-	-	-	-		-	-	-	-	50	400	400	1600	
Air conditioning control functions	ON/OFF	●	●	●	●	●		●	●	●	●	●	●	●	●	
	Operation mode setting	●	●	●	●	●		-	●	●	●	●	●	●	●	
	Fan speed control	●	●	●	●	●		●	●	●	●	●	●	●	●	
	Room temperature setting	●	●	●	●	●		●	●	●	●	●	●	●	●	
	Setting temperature range limitation	●	●	●	-	-		●	-	-	-	●	●	●	●	
	Test operation	●	●	●	●	●		●	●	●	-	-	●	-	-	
	Vertical louver setting	●	●	●	●	-		●	●	●	-	-	●	●	●	
	Horizontal louver setting	●	●	●	●	-		-	●	-	-	-	●	●	●	
	Individual louver control	●	-	-	●	-		-	-	-	-	-	●	● ^{*3}	-	
	Group setting	-	-	-	-	-		-	-	-	-	-	●	●	●	
	Remote controller prohibition	-	-	-	-	-		-	-	-	-	●	●	●	●	
	Anti-freeze setting	●	-	-	●	-		-	-	-	-	●	●	●	●	
	Set temperature auto return	●	●	●	-	-		-	-	-	-	-	●	-	-	
	Economy mode setting	●	●	●	●	-		-	●	●	●	●	●	●	●	
	Occupancy sensor control	●	-	-	-	-		-	-	-	-	●	●	●	●	
Displayed items	Error	●	●	●	●	●		●	-	-	●	●	●	●	●	
	Defrosting	●	●	●	●	●		●	-	-	-	●	●	●	●	
	Current time	●	●	●	-	-		-	●	●	●	●	●	●	●	
	Day of week	●	●	●	-	-		-	-	-	-	●	●	●	●	
	Remote controller prohibition	●	●	●	●	●		●	-	-	●	●	●	●	●	
	Address display	●	●	●	●	●		●	-	-	-	-	●	●	●	
	Room temperature	●	-	●	●	-		●	-	-	-	● ^{*4}	● ^{*4}	● ^{*4}	● ^{*4}	
	Multiple language support	●	-	●	-	-		-	-	-	●	●	●	●	●	
	Setting for daylight saving time	●	-	●	-	-		-	-	-	●	●	●	●	●	
	Name registration	●	-	-	-	-		-	-	-	-	●	●	●	●	
	Backlighting	●	-	●	●	●		●	-	-	●	●	●	-	-	
	2D floor layout/3D building display	-	-	-	-	-		-	-	-	-	-	-	-	●	
	Refrigerant leak detector	-	-	-	-	-		-	-	-	-	●	●	●	●	
	Timer	Schedule timer	Period	Week	Week	Week	-		-	-	-	Week	Week	Year	Year	Year
			ON/OFF, Temp, Mode, Times per day	8	4	8	-		-	-	-	4	20	20	144	144
ON/OFF timer		●	●	●	●(OFF only)	-		-	●	●	-	-	-	-	-	
Sleep timer		-	-	-	-	-		-	●	●	-	-	-	-	-	
Program timer		-	-	-	-	-		-	●	●	-	-	-	-	-	
Auto-off timer		●	●	●	-	-		-	-	-	-	●	●	-	-	
Control	Day off	●	●	●	-	-		-	-	-	●	●	●	●	●	
	Minimum unit of timer setting (minutes)	10 • 30	30	30	-	-		-	5	5	5	10	10	10	10	
	Remote monitoring management system	-	-	-	-	-		-	-	-	-	●	●	●	●	
	Electricity charge apportionment	-	-	-	-	-		-	-	-	-	-	○	○	●	
	Error history	●	●	●	-	-		-	-	-	-	●	●	●	●	
	Emergency stop	-	-	-	-	-		-	-	-	-	● ^{*2}	● ^{*2}	-	-	
	Remote monitoring management	-	-	-	-	-		-	-	-	-	●	●	○	●	
	Energy-saving management	-	-	-	-	-		-	-	-	-	-	-	○	○	
	E-mail notification in case of failure	-	-	-	-	-		-	-	-	-	●	●	●	●	
	Key lock	● Child lock	● Child lock	● Child lock	-	-		-	-	-	-	● Child lock	● Password setting	● Password setting	● Password setting	● Password setting
Low noise mode	-	-	-	-	-		-	-	-	●	-	●	●	●		

*1 "Operation mode" setting not available.
 *2 Available only for external input control.
 *3 Monitoring sites can be set up.
 The main unit side can only be operated to cancel the settings.
 *4 Available only when using Wired remote controller.
 ●: Supported ○: Optional function -: Unsupported

Wired remote controller (with touch panel)

UTY-RNRGZ5



Up to **16** indoor units
Up to **1** group

Easy operation due to large high-resolution STN-LCD touch panel screen

- Touch screen LCD
- Built-in daily/weekly timer (ON/OFF, temperature, modes)
- Backlit screen for easy operation in the dark.
- Room temperature display
- Controls up to 16 indoor units
- Supports 12 languages: Chinese, Dutch, English, French, German, Greek, Italian, Polish, Portuguese, Russian, Spanish, and Turkish
- Nonpolar 2-core type

High performance and compact size

A single remote controller controls each connected indoor unit and provides a weekly timer function and a variety of energy-saving options.



Accurate control for comfort

A thermo sensor built into the remote controller monitors room temperature accurately.

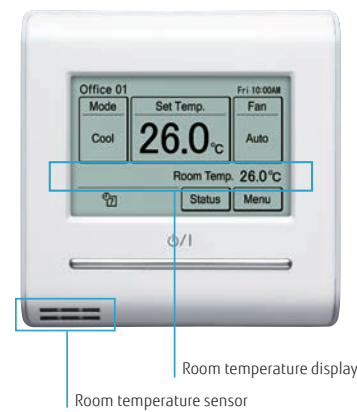

Energy saving controls

Custom Auto

- Maintains 2 separate setpoints for heating and cooling operations.
- Automatically switches between heating and cooling modes.

* Not available for some models

Auto-off timer

- While the Auto-off timer is activated, if the set off time is specified as, for example, one hour, the power will automatically turn off one hour after the start of operation.
- A desired time frame can be specified for the Auto-off timer.
- The off-time can be set from 30 to 240 minutes.

2-setting weekly timer

Set temperature auto return

Setting temperature range limitation

Cooling set temp. 27°C, Heating set temp. 26°C

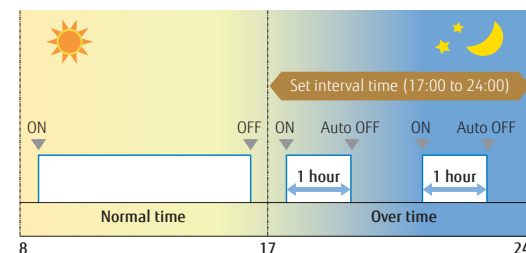
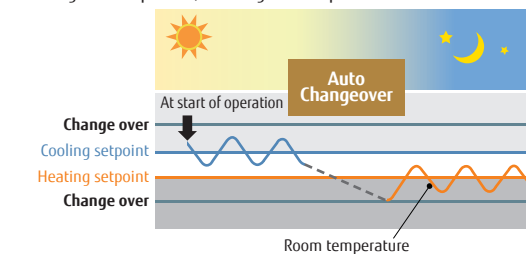

e.g.) Between 17:00 and 24:00 (over time hours), when the 1 hour set off time has elapsed, the system will automatically turn off the indoor unit as it

Features: Wired Remote Controller (Touch Panel)

Refrigerant cycle monitor (Option)

Wired Remote Controller (Touch Panel) will support to display some sensor values for maintenance and service support.

* This function is only supported by split units, using the H-Serial communication protocol! Example: ASYH30KMTB

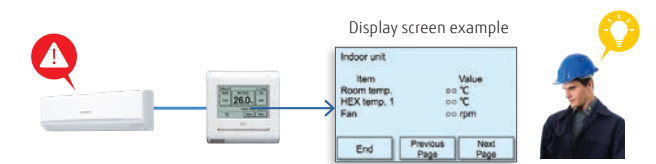

Multi System Control*1

1) Lead Lag Operation

Standby Indoor Unit can be selected in lead lag operation. By this, the Indoor units will last longer than operating by nonstop.

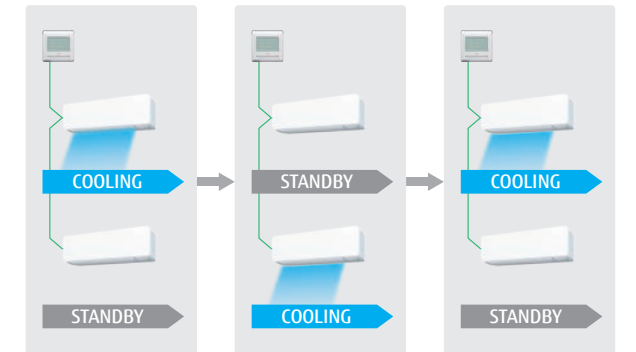

2) Back up operation

In case of unexpected Indoor unit error, other Indoor units will start providing back up operation.

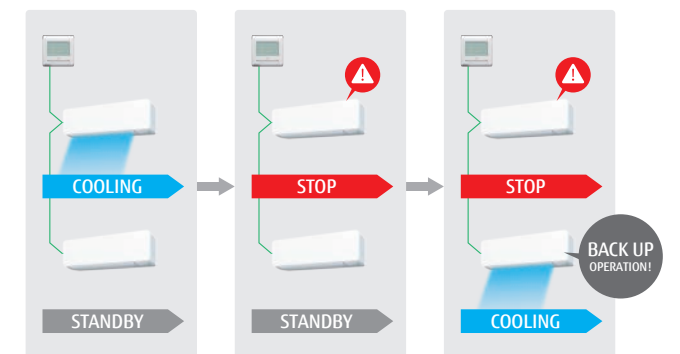

3) Lag Operation

In case of unexpected room temperature rise, other Indoor Units will start providing lag operation.

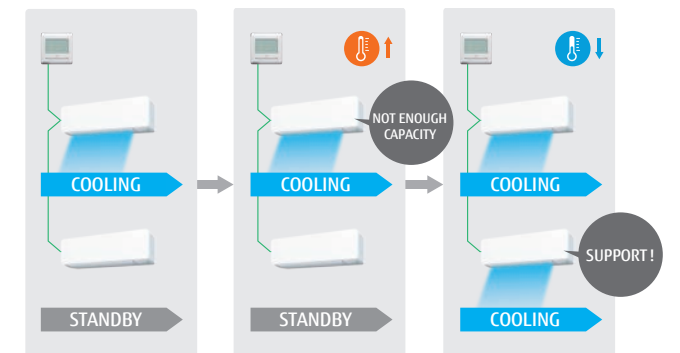

*1: "Lead Lag Setting" is an easy-to-use function for room temperature control when using multiple indoor units, while reducing the burden placed on each indoor unit.

If you wish to make use of this function, ensure you use indoor units equipped with a "Special Cooling" function.

For Split products with "Special Cooling" function, refer to S-054 to S-057.

If you use indoor units that do not have a "Special Cooling" function, under certain conditions, there is a chance that "Backup operation" may not operate correctly, and the "Lead Lag Setting" function will not give the expected results.

Additionally, for rooms that require strict conditions, such as server rooms, please consider other appropriate measures.

Please note that we will not provide compensation for any damages suffered to your appliances or data as a result of using this function.

For more details, please confirm with your nearest retail store.

Specifications

Model name	UTY-RNRGZ5
Power Source	DC 12 V
Dimensions (H × W × D) (mm)	120 × 120 × 20.4
Weight (g)	220

DC 12 V is supplied by the indoor unit.

Wired remote controller

UTY-RLRG



- ON/OFF/Weekly timer settings
- A built-in thermo sensor monitors and controls room temperature accurately.
- When something goes wrong, an error code is displayed.
- 16 error codes from the most recent one will be kept in the history. (Last 16 error codes can be accessed)
- Nonpolar 2-core type

Up to
16 indoor units
Up to
1 group

High performance and compact size

A single remote controller controls each connected indoor unit and provides a weekly timer function and a variety of energy-saving options.



Visually intuitive operation

- The operation mode, set temperature, and fan speed are shown prominently on the top screen.
- Each function to be set is indicated by an icon.
- The control guide makes it simple and straightforward to operate a remote controller.

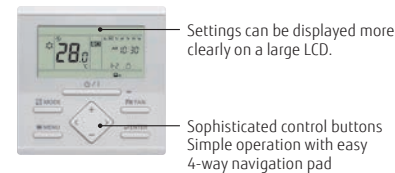

Compact wired remote controller

UTY-RCRGZ1



- Simple design that matches stylish interiors
- The body of the controller, which is easy to install, is designed to conform to the European standard junction box.
- Can be operated both by wireless and wired remote controller.
- Nonpolar 2-core type

Up to
1 indoor units
Up to
1 group

Large screen and simple display

- Large screen but compact size
- Large, easy-to-read letters are used.
- The controls are simple and easy to understand.

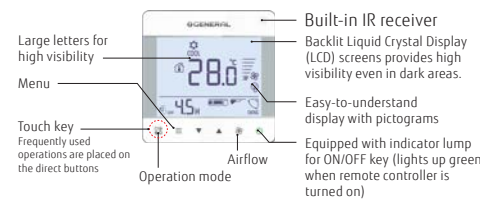

System overview

VRF connection

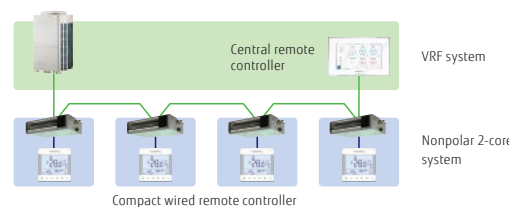

RAC connection

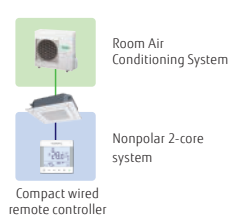

Specifications

Model name	UTY-RLRG	UTY-RCRGZ1
Power source	12 V DC	12 V DC
Dimensions (H × W × D) (mm)	120 × 120 × 17	86 × 86 × 44
Weight (g)	170	135

12 V DC supplied by an indoor unit

Wired remote controller

UTY-RVNGM



Up to
16 indoor units
Up to
1 group

Hi-grade individual control with a wide range of functions.

- 3.7-inch backlit LCD screen.
- Supports energy-saving functions with simple operation.
- Supports 9 languages: English, French, German, Greek, Italian, Portuguese, Russian, Spanish, and Turkish

Visually intuitive operation

- Each function is displayed as an icon.
- Main functions are indicated by large icons: "Mode," "Set Temp," and "Fan"
- Easy operation with control guide display
- Simple operation with easy 4-way navigation pad

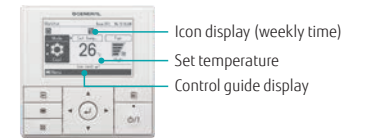

High performance and compact size

- A single remote controller controls each connected indoor unit and provides a variety of energy-saving options.



Wired remote controller

UTY-RNNGM



Up to
16 indoor units
Up to
1 group

- Simple operation with Built-in Weekly/Daily Timer.
- Control up to 16 indoor units.
- Up to 2 Wired remote controllers can be connected to a single indoor unit.

Accurate control for comfort

A thermo sensor built into the remote controller monitors room temperature accurately. The wired remote controller and an optional Remote sensor can be installed in any location to meet any requirement.

Examples of sensor changes

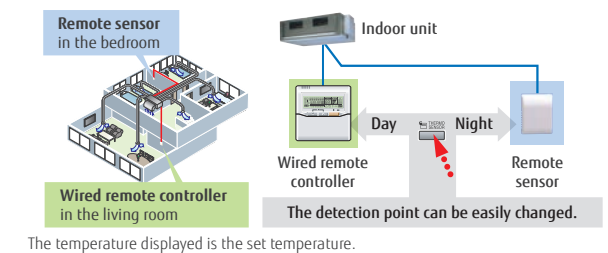

Built-in timer

Weekly timer: ON/OFF time can be set to operate twice for each day of the week.
Temperature setback timer: Sets the time to change the temperature setting and the time to hold the setting for each day of the week.
 At "Weekly timer" + "Temperature setback timer" setup

Specifications

Model name	UTY-RVNGM	UTY-RNNGM
Power source	12 V DC	12 V DC
Dimensions (H × W × D) (mm)	120 × 120 × 21.3	120 × 120 × 18
Weight (g)	220	160

12 V DC supplied by an indoor unit

Simple remote controller

UTY-RSRG / UTY-RHRG (without operation mode)

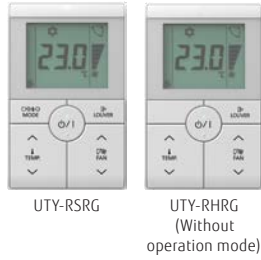

Compact remote controller with basic functionality

- Up to 16 indoor units can be controlled with one remote controller.
- Suitable for hotels or offices as it is easily operated with no complex functions.
- Simple design that matches stylish interiors
- Large LCD screen and easy-to-use control buttons
- Backlight: White backlight makes it easy to operate in the dark.
- Nonpolar 2-core type

Up to
16 indoor units
Up to
1 group

Supports a variety of applications

- **Vertical louver control:** Adjusts the vertical airflow direction of a duct-type indoor unit with an auto louver or a cassette type installed in a hotel room or a conference room.
- **Setting temperature range limitation:** Enables an indoor unit to operate in an energy-saving manner in a small building not equipped with a central remote controller.
- **Built-in room temperature sensor:** Monitors and controls room temperature accuracy.

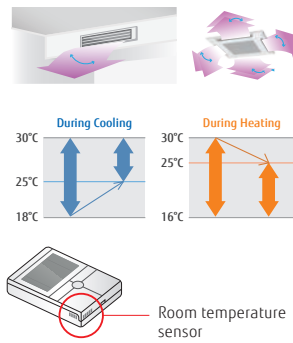

Simple remote controller

UTY-RSNGM



Compact remote controller with basic functionality

- Up to 16 indoor units can be controlled with one remote controller.
- Suitable for hotels or offices as it is easily operated with no complex functions.
- Backlit screen for easy operation in the dark.
- Polar 3-core type

Up to
16 indoor units
Up to
1 group

Easy-to-use operation

- Enables basic control of an indoor unit, such as ON/OFF, fan speed, operation mode select, and room temperature setting.
- A large ON/OFF button is located in the middle for quick access.
- Works with other individual control units.
- When something goes wrong, an error indicator will appear, and diagnostics can be performed with the remote controller.

Specifications

Model name	UTY-RSRG	UTY-RHRG	UTY-RSNGM
Power source	12 V DC	12 V DC	12 V DC
Dimensions (H × W × D) (mm)	120 × 75 × 19.4	120 × 75 × 19.4	120 × 75 × 19.4
Weight (g)	120	120	120

12 V DC supplied by an indoor unit

Wireless remote controller

UTY-LNTG



Simple and versatile operations with a choice of 4 different types of timers

- Controls up to 16 indoor units.

Built-in timer

4 timer programs: ON/OFF/Program/Sleep
 Program timer: Sets ON/OFF time once for every 24 hours.
 Sleep timer: Adjusts the set temperature automatically while the sleep timer is on.

Up to
16 indoor units
Up to
1 group
Up to
4 different daily timers

Easy installation and operation

Different codes can be assigned to up to 4 indoor units to prevent a mix-up.
 Wide and precise transmitting range

Wireless remote controller

UTY-LNHG



Simple and versatile operations with a choice of 4 different types of timers

- Controls up to 16 indoor units.

Built-in timer

4 timer programs: ON/OFF/Program/Sleep
 Program timer: Sets ON/OFF time once for every 24 hours.
 Sleep timer: Adjusts the set temperature automatically while the sleep timer is on.

Up to
16 indoor units
Up to
1 group
Up to
4 different daily timers

Easy installation and operation

Different codes can be assigned to up to 4 indoor units to prevent a mix-up.
 Wide and precise transmitting range

Specifications

Model name	UTY-LNTG	UTY-LNHG
Battery	1.5 V (R03/LR03/AAA)	1.5 V (R03/LR03/AAA)
Dimensions (H × W × D) (mm)	205 × 61 × 17	170 × 56 × 19
Weight (g)	125	85

12 V DC supplied by an indoor unit

IR receiver unit for duct type

UTY-LRHGM / UTY-LBTGM

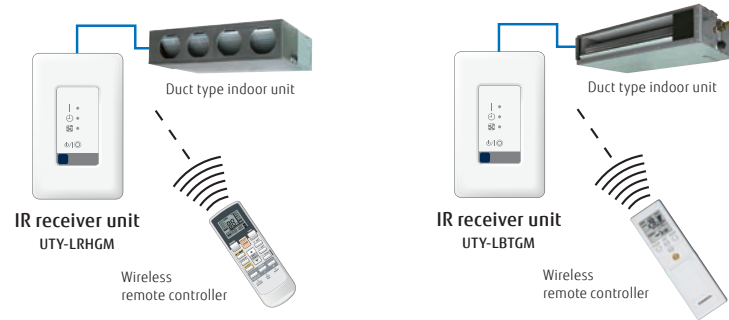

The wireless remote controller controls duct type indoor units.

IR receiver unit for Cassette

UTY-LBTGC



Cassette type indoor unit can be controlled with a Wireless remote controller.

IR receiver unit for ceiling type

UTY-LBTGH



The wireless remote controller controls ceiling type indoor units.

Specifications

< Wireless Remote Controller >

Model name	UTY-LRHGM	UTY-LBTGM	UTY-LBTGC	UTY-LBTGH
Battery	1.5 V (R03/LR03/AAA)	1.5 V (R03/LR03/AAA)	1.5 V (R03/LR03/AAA)	1.5 V (R03/LR03/AAA)
Dimensions (H × W × D) (mm)	170 × 56 × 19	205 × 61 × 17	205 × 61 × 17	205 × 61 × 17
Weight (g)	85	125	125	125

< IR Receiver Unit >

Battery	DC5V	DC5V	DC5V	DC5V
Dimensions (H × W × D) (mm)	145 × 90 × 30	145 × 90 × 30	-*	-*
Weight (g)	150	150	140	100

DC 5 V is supplied the indoor unit.

*It will replace the parts of the indoor unit to be connected.

IR receiver unit for duct type

UTB-YWC / UTY-TRHX



The wireless remote controller controls duct type* indoor units.

*Large airflow duct types do not work with this IR receiver unit.



*A separate wireless remote control (model: UTY-LNHG) is required.

IR receiver unit for Cassette

UTY-LBHXD / UTY-TRHX



Cassette type indoor unit can be controlled with a Wireless remote controller.

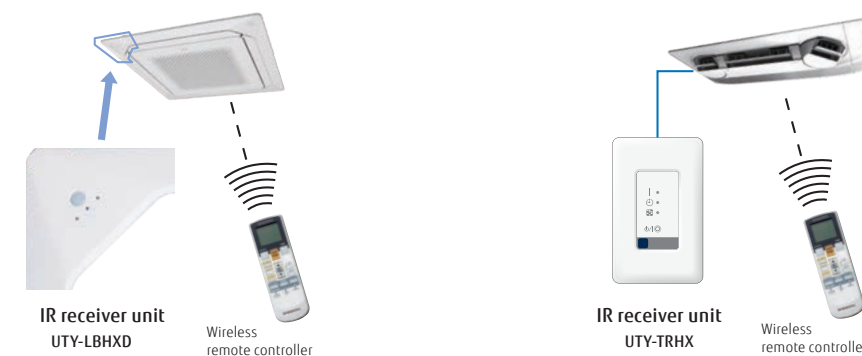

*A separate wireless remote control (model: UTY-LNHG) is required.

Specifications

< Wireless Remote Controller >

Model name	UTB-YWC	UTY-LBHXD	UTY-TRHX
Battery	1.5 V (R03/LR03/AAA)	1.5 V (R03/LR03/AAA)	1.5 V (R03/LR03/AAA)
Dimensions (H × W × D) (mm)	170 × 56 × 19	170 × 56 × 19	170 × 56 × 19
Weight (g)	85	85	85

< IR Receiver Unit >

Battery	DC5V	DC5V	DC5V
Dimensions (H × W × D) (mm)	145 × 90 × 30	-*	145 × 90 × 30
Weight (g)	150	140	150

DC 5 V is supplied the indoor unit.

*It will replace the parts of the indoor unit to be connected.

WLAN adapter

UTY-TFSXH3 / UTY-TFSXJ3



NEW



USB type for single split models
UTY-TFSXH3

“AIRSTAGE Mobile” is an application software that enables you to manage the Fujitsu General’s air conditioner(s) with a mobile device from anywhere.

- Maximum 5 accounts per 1 indoor unit
- Room / Outdoor temperature display
- Can be used for a Single / Multi and VRF indoor units.
- No separate external power supply required



UTY-TFSXJ3
(CN connector type)

Up to
1 indoor units

User Friendly for Everyone

Enjoy easy-to-use centralized operation of air conditioners via a smartphone anytime, anywhere



Image*



House Owner

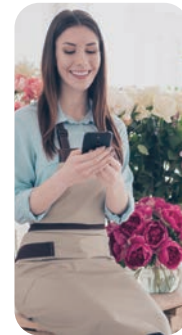

Shop Owner



Commercial Building Owner

Main Functions

- ON / OFF
- Operation mode
- Fan speed
- Louver position
- Set temperature control
- Weekly timer
- Room temperature display
- Outdoor temperature display
- Error display



*Contents of display differ depending on the type of indoor unit.

New Design!

Ease of use is pursued to achieve a stylish design.

The more legible and accessible timer UI enables effortless schedule management.

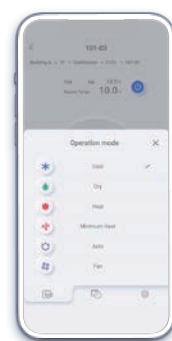

Mode change



Fan speed change



Weekly timer

Features: AIRSTAGE Mobile

Centralized operation for flexible remote management of all air conditioners

AIRSTAGE Mobile is ideal for a wide range of applications, from large residential buildings to smaller commercial spaces such as offices and stores. Anyone who has a smartphone and an adapter can easily manage the system at a low cost.

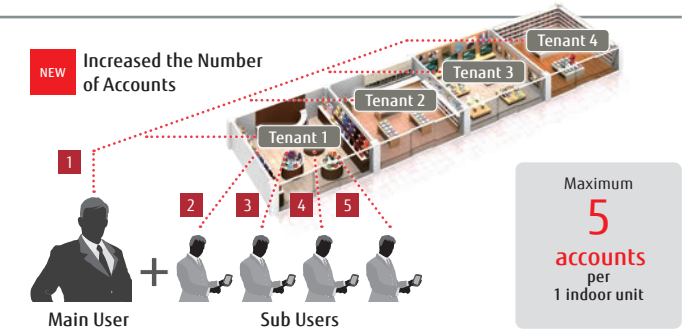

Hierarchical group management

Multiple air conditioners can be combined into a single group for centralized operation. Several groups can also be organized at once. Grouping the air conditioners by building, floor, or room makes it easy for users to monitor their operation status and operate them quickly.



Operate air conditioner and check its operation status just by talking to it

Connecting with a smart speaker allows the user to operate the air conditioner and check its operation status just by talking to it.

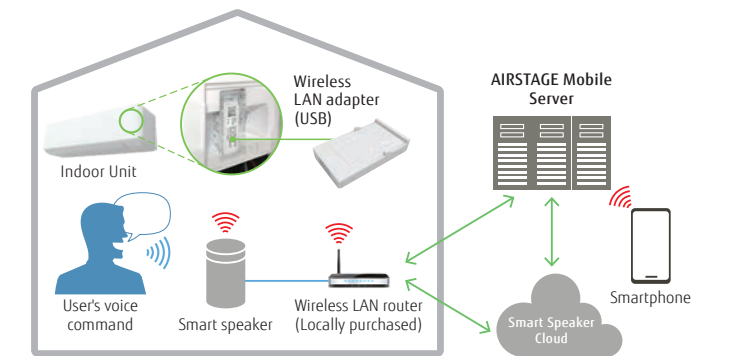

* The new WLAN adapters for AIRSTAGE Mobile are upper compatible for the indoor units that can connect the following WLAN adapters for FGLair.

	CN connector type	USB type
for FGLair	UTY-TFSXZ1	UTY-TFSXF2
for AIRSTAGE Mobile	UTY-TFSXJ3	UTY-TFSXH3

Specifications

Model name	UTY-TFSXJ3(CN connector type)	UTY-TFSXH3
Dimensions (H × W × D) (mm)	71 × 38 × 15	56.7 × 34 × 9.72
Weight (g)	35	30

WLAN adapter

UTY-TFNXZ1 / UTY-TFSXZ1 / UTY-TFSXF2



USB type for single-split models
UTY-TFSXF2



UTY-TFNXZ1
(3-wire RC-line type)
UTY-TFSXZ1
(CN connector type)

Up to
1 indoor units



- This interface provides the most advanced solution for the remote management of an air conditioning system by using smartphones, tablets, and computers.
- No separate external power supply required
- Can be used for a Single / Multi and VRF indoor units.

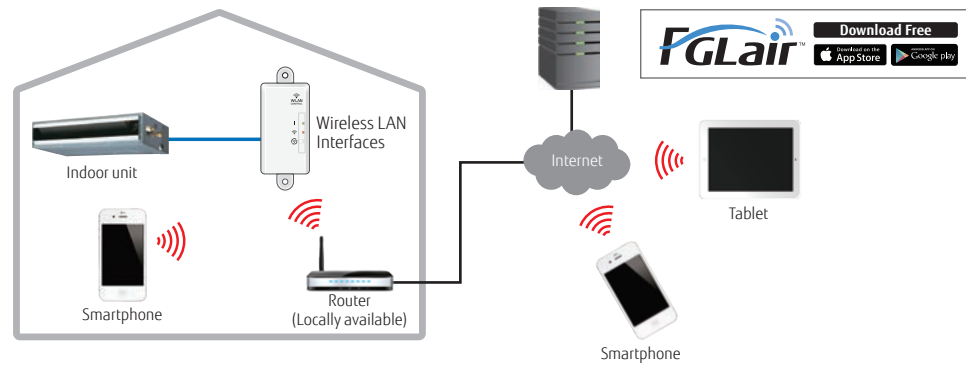

Basic control

- Turning the units on and off
- Mode control (Heat, Cool, Dry, Auto, Fan)
- Fan speed control
- Louver position (airflow direction setting)
- Timer operation setting (Weekly timer)
- Economy mode setting

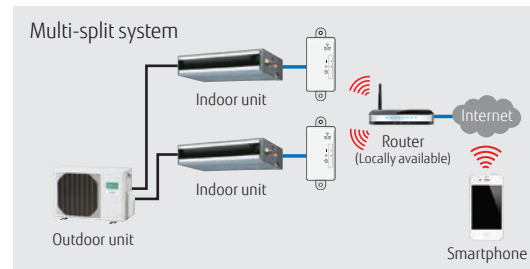

Multiple air conditioning management

- Manage multiple air conditioning systems in different locations.

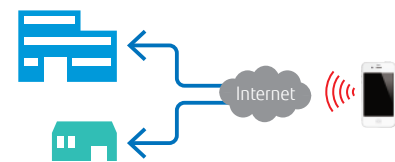

Error alert and e-mail notice

- E-mail notification alerts
- Air conditioning malfunction alert
- Enables quick service response when errors occur.

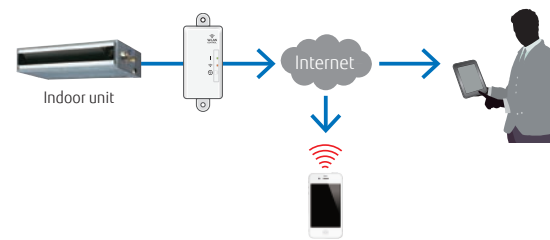

WLAN adapter (USB type) UTY-TFSXF2

A compact USB type is available. No need for specialized installation. Easily installed on the indoor unit.



Specifications

Model name	UTY-TFNXZ1 (3-wire RC-line type)	UTY-TFSXZ1 (CN connector type)	UTY-TFSXF2
Dimensions (H × W × D) (mm)	71 × 38 × 15	71 × 38 × 15	56.7 × 34 × 9.72
Weight (g)	35	35	30

WLAN adapter

FG-RC-WIF1Z2 / FG-IR-WIF1Z1 / FG-AC-WIF1Z1



FG-RC-WIF1Z2
(3-wire RC-line type)



FG-AC-WIF1Z1
(CN connector type)



FG-IR-WIF1Z1
(IR type)

Up to
1 indoor units

AC Cloud Control

- This interface provides the most advanced solution for the remote management of an air conditioning system by using smartphones, tablets, and computers.
- No separate external power supply required

Installation example

[3-wire RC-line type/CN connector type]

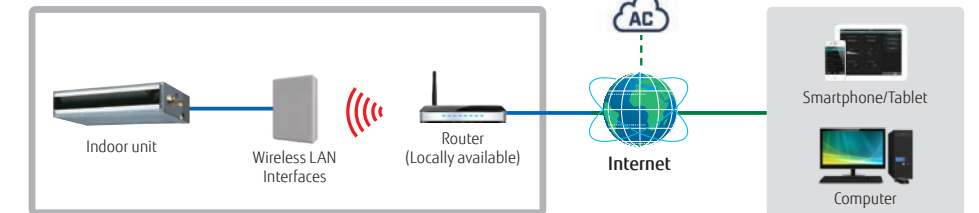

[IR type] Connection to wall-mounted type

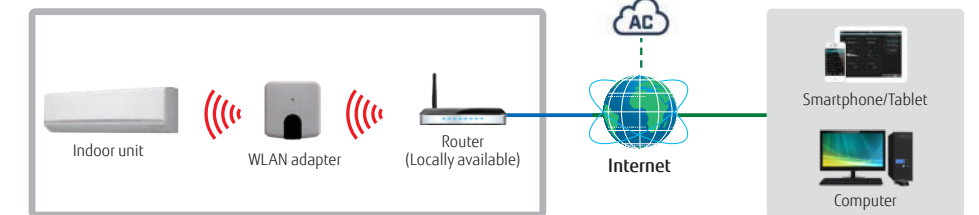

[IR type] Connects to the product with the optional receiver kit

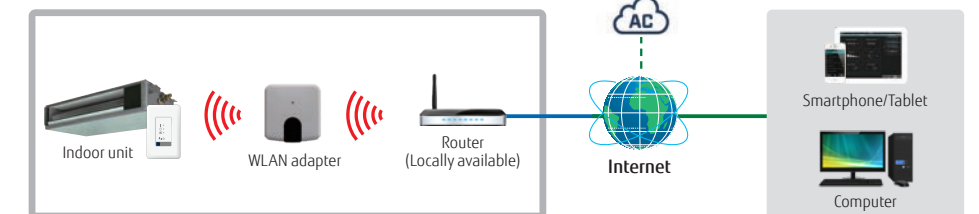

*IR receiver required.

Basic control

- Turning air conditioner on and off
- Mode select (Heat, Cool, Dry, Auto, Fan)
- Louver position (airflow direction setting)
- Fan speed control
- Room temperature display
- Setting temperature
- Multiple language support
- One single scene is created.

Advanced control (optional functions)

- Climate-based operation modes (ECO, Comfort, and Powerful) (to be available in the future)
- Schedule functions (ON/OFF, modes, set temperature, fan speed, louver position)
- Setting temperature range limitation
- Multiple Scenes and Calendars are created.
- Smart Speaker compatibility
- Advanced internet service connections

Notification and operation history

- E-mail notification alerts
- Air conditioning malfunction alert
- Connectivity monitoring and alert
- Operation history (to be available in the future)

Specifications

Model name	FG-RC-WIF1Z2 (3-wire RC-line type)	FG-AC-WIF1Z1 (CN connector type)	FG-IR-WIF1Z1 (IR type)
Number of controllable groups	1	1	1
Dimensions (H × W × D) (mm)	108 × 70 × 28	81 × 78 × 28	127 × 50 × 17
Weight (g)	80	76	80

Multiple protocol WLAN adapter

FG-RC-WMP1Z1 / FG-IR-WMP1Z1 / FG-AC-WMP1Z1



Intesis
BY HBS NETWORKS



FG-RC-WMP1Z1
(3-wire RC-line type)

Intesis
BY HBS NETWORKS



FG-AC-WMP1Z1
(CN connector type)

Intesis
BY HBS NETWORKS



FG-IR-WMP1Z1
(IR type)

Up to
1 indoor units

Specifications

Model name	FG-RC-WMP1Z1 (3-wire RC-line type)	FG-AC-WMP1Z1 (CN connector type)	FG-IR-WMP1Z1 (IR type)
Number of controllable groups	1	1	1
Dimensions (H × W × D) (mm)	70 × 100 × 28	127 × 50 × 17	81 × 78 × 28
Weight (g)	98	80	76

Multiple protocol LAN adapter

FG-TL-MBS16Z1



Intesis
BY HBS NETWORKS



FG-TL-MBS16Z1
(VRF type)

Up to
16 indoor units

Specifications

Model name	FG-TL-MBS16Z1 (VRF type)
Power supply	9 to 36 V DC, Max.: 140 mA or 24 V AC 50/60 Hz, Max.: 127 mA.*
Input power (W)	1.7
Dimensions (H × W × D) (mm)	90 × 88 × 56
Weight (g)	330

*24 V DC power supply is recommended.

AC Cloud Control

- Air conditioner control of Home Automation systems via wireless LAN connection.
- No separate external power supply required

Installation example

[3-wire RC-line type/CN connector type]

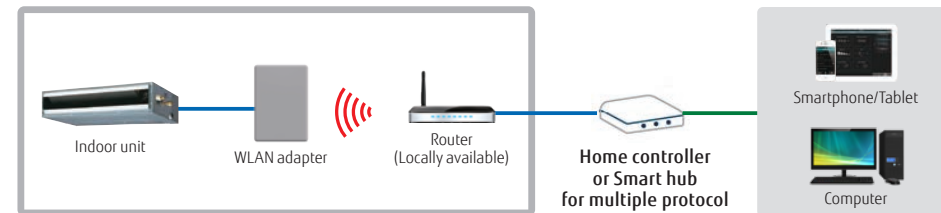

[IR type]

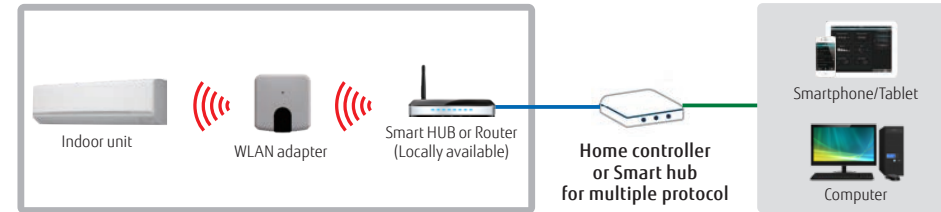

*IR receiver required for other than wall-mounted type.

Home central remote controller

UTY-DMMGM / UTY-DMMGM1



Up to
1 multi-split system
Up to
6 indoor units

For 5-unit and 6-unit multi-split type

- Batched control of up to 6 indoor units For all indoor units connected to the remote controllers, the Home central remote controller sets room temperature, airflow volume, and remote controller prohibition from other remote controllers at once.
- Supports 9 languages: English, French, German, Greek, Italian, Portuguese, Russian, Spanish, and Turkish.
- Large backlit LED screen
- Large, easy-to-see operation panel

Example of system configuration

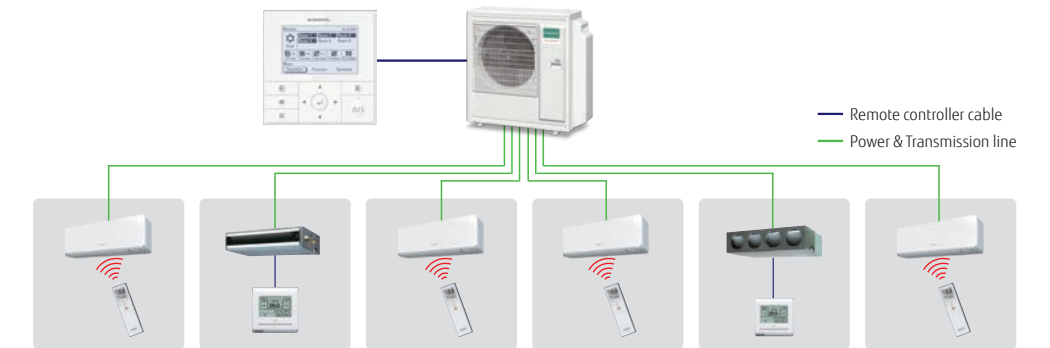

Home central remote controller

Weekly timer

Up to 4 ON/OFF settings can be programmed per day. Two weekly patterns can be set, one for the cooling season and the other for the heating season.

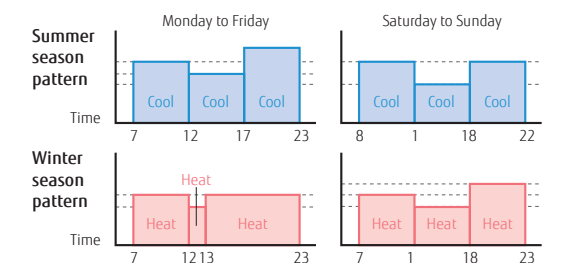

Low noise operation

You can choose from 4 low noise levels depending on the installation environment. ON/OFF timing of low noise mode can be set with the timer.

10°C heat operation

When you leave the house, the air conditioner runs a minimum heating operation to maintain the room temperature at 10°C.

*Consult your dealer for conditions of use.

Economy operation

When you select energy-saving economy mode, the temperature setting for the indoor unit increases (during cooling operation) or decreases (during heating operation) by 1°C and the maximum electric value of the outdoor unit is suppressed.

Prohibiting local control, including settings such as child lock

The Home central remote controller is equipped with a lock function to prevent unauthorized operation from the remote controllers of the indoor unit in each room. The Home central remote controller is equipped with a child lock to prevent children from accidentally turning the air conditioner on or off or changing its settings.

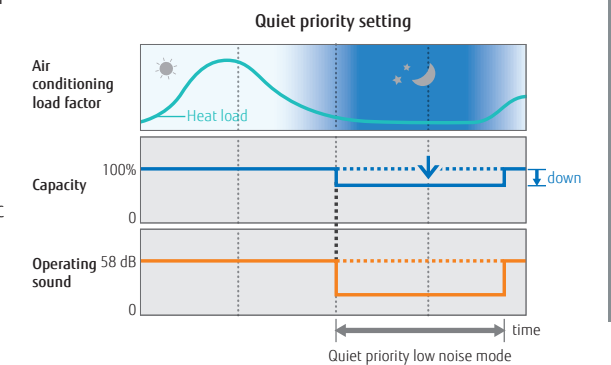

Specifications

Model name	UTY-DMMGM/UTY-DMMGM1
Power source	12 V DC
Dimensions (H × W × D) (mm)	120 × 120 × 21.3
Weight (g)	220

12 V DC supplied by an indoor unit

Central Remote Controller

UTY-DCGGZ2



Up to **100** indoor units
Up to **50** groups

For tenants in small to midsize commercial premises

- Individual control and monitoring of up to 100 indoor units
- 7.0inch TFT color screen
- Visually intuitive operation
- Room temperature display by indoor unit sensor & remote controller sensor
- 50 Remote Controller Groups Display & remote controller group rename
- Supports 12 languages: Chinese, Dutch, English, French, German, Greek, Italian, Polish, Portuguese, Russian, Spanish, and Turkish

Easy operation

Air conditioning management by detecting room temperatures of each room

The room temperature detected with indoor unit sensor or remote controller sensor can be displayed. New model can detect the room temperature by indoor units sensors even if wired remote controllers are not connected to the indoor units.

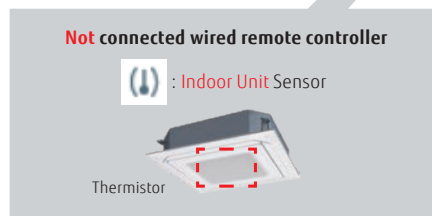

*Room temperature is displayed only when indoor unit operates.

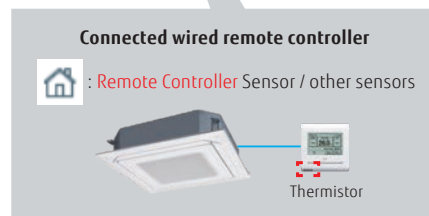

50 Remote Controller Groups Display

The group display and the 50 remote controller groups display can be switched easily. Users can choose which display is better, depending on the situation.

Group Display



Manage & Monitor by each Groups

50 Remote Controller Groups Display

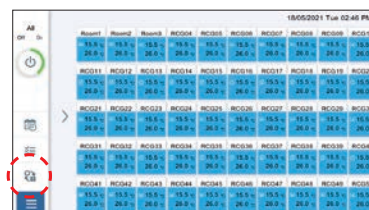

Manage & Monitor by 50 Remote Controller Groups



Remote Controller Groups Rename

The remote controller group names can be changed. Users can know easily where the air conditioning is located by changing the remote controller group names.

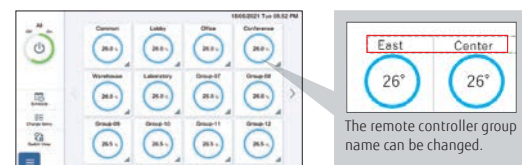

The remote controller group name can be changed.

Features: Central Remote Controller

- Easy intuitive operation from the touch panel display.
- All functions can be accessed through the monitoring screen showing a pop-up window for detailed operation.

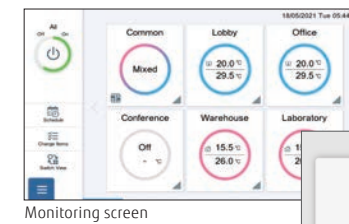

Monitoring screen

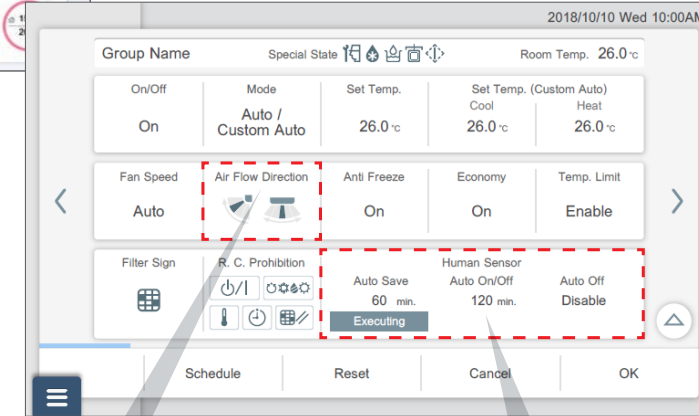

Individual setting

Added individual wind direction control

Individual wind direction control has been added.
Circular Flow cassette / 3D Flow cassette



Circular flow cassette

Occupancy sensor Compatible

Occupancy sensor setting
• Auto save
• Auto on / off
• Auto off detection time
• Enable and disable

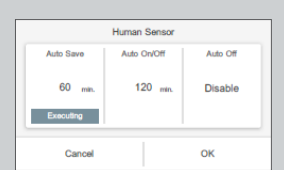

Remote Management

Remote monitoring / Remote operation

New central remote controller can control your tenant's air conditioner anytime and anywhere.

When the central remote controller manages the indoor units of some tenants, air conditioning of each tenant can be managed separately online.

Increased the Number of Accounts

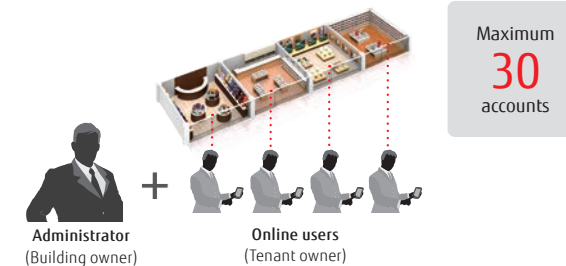

Trouble support function

Display error details

Display descriptive explanation when an error occurs



Sensor value monitoring function

Monitor sensor data of indoor unit / outdoor unit, send mail

Notify room temperature by email*

Notify by e-mail when the temperature around the air conditioner is too high or too low

*This function is available only when using wired remote controller.

Specifications

Model name	UTY-DCGGZ2
Power Supply	100-240 V 50/60 Hz
Dimensions (H × W × D) (mm)	134.6 × 216.2 × 37.9
Weight (g)	800

Touch panel controller

UTY-DTGGZ1



- Large 7.5-inch TFT color LCD screen
- Touch screen operation
- Stylish design to fit nicely into any room environment
- Controls up to 400 indoor units.
- Icon or list view can be selected in monitoring mode.
- Supports 7 languages: Chinese, English, French, German, Polish, Russian, and Spanish.
- Mounted with LAN adapter for remote control & operation, external input/output with emergency stop and batch ON/OFF

Up to
400 indoor units
Up to
100 outdoor units
Up to
400 groups

Easy operation

- Wide range of simple-to-understand icons
- Operate by pressing the icons on the screen with your finger or a stylus.
- The color on the back identifies the current control operation; blue is for monitoring and green is for operational control.

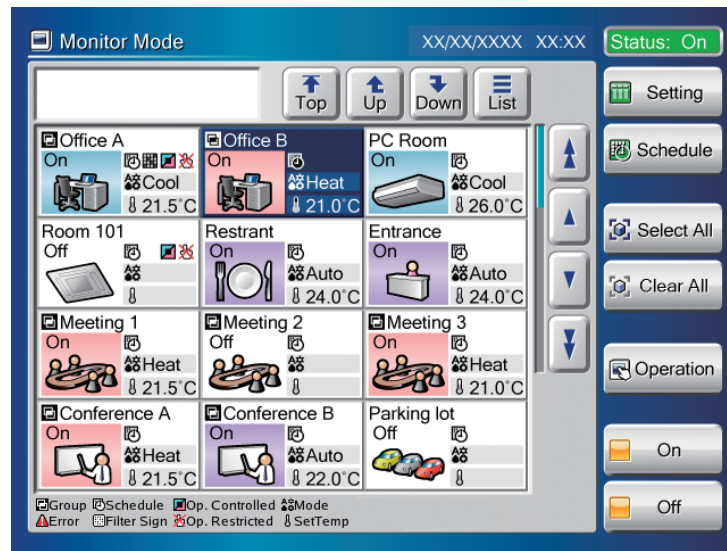

Easy maintenance

- The flat touch panel can be easily cleaned.
- Touch panel controller with non-glare coating to prevent finger marks
- Front cover for easy removal.



Easy installation

- The touch panel controller can be mounted on a wall.
- Flat back surface enables easy installation anywhere on a wall.
- No additional parts or components required for installation



Controls up to 400 indoor units.

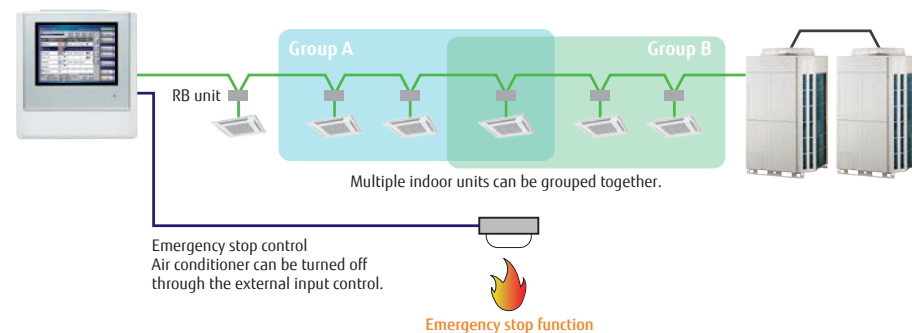

Features:

Control & monitoring

- Control and monitor Fujitsu General air conditioners via LAN or internet.
- Users and tenants can manage their assigned equipment from anywhere by computer or tablet.
- When something goes wrong, an error notice is sent by e-mail for prompt troubleshooting.

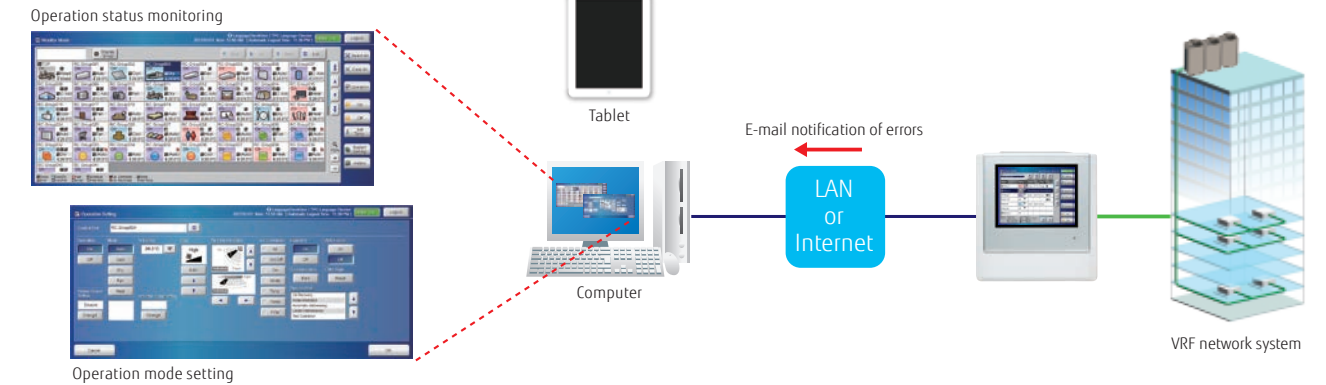

Smartphone

Model name	Browser
Nexus 6P (Android 7.1.1)	Google Chrome 5.5
iPhone 7 (iOS 10.1)	Safari 10

Tablet

Model name	Browser
iPad Pro 9.7 inch (iOS 10.2.1)	Safari 10

Flexible access permissions can be granted to users at each point level.

The administrator can register multiple users and permit them to access any indoor unit and any functions.

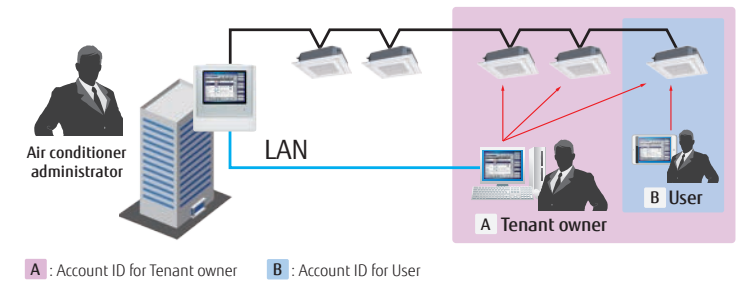

Additional languages

Supports 7 languages as standard: Chinese, English, French, German, Polish, Russian, and Spanish. Create a language database to integrate additional languages into the remote device. The added languages will only be displayed on the remote device and cannot be added to the Touch panel controller.

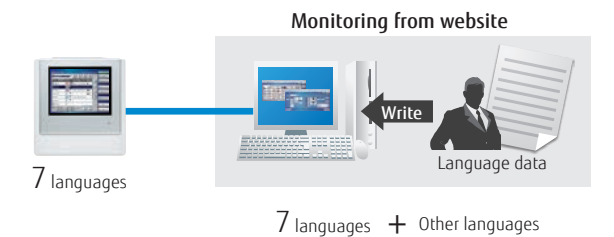

Electricity charge apportionment (Option: UTY-PTGXA)

- Energy cost can be calculated and allocated to each billing user in proportion to the amount of energy used for air conditioning.

- Apportionment charge/bill calculation
- Tenant (block) setting
- Common facilities apportionment setting
- Rated power consumption allotment setting
- Individual calculations for cooling and heating
- Electricity meter supported

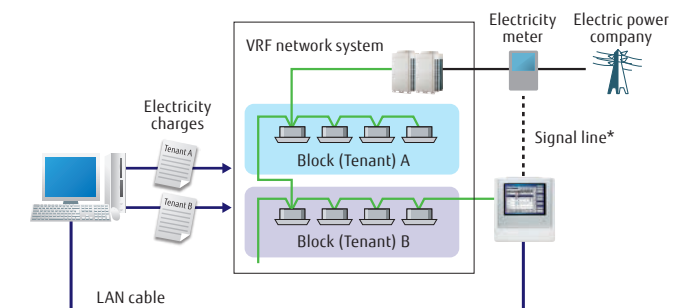

* An electricity usage meter can be connected to an external input connector of the Touch panel controller. In that case, the meter cannot be connected to an outdoor unit at the same time.

Features:

Automatic setting for daylight saving time

Functions provided

- 1) Schedule setting for daylight saving time
 - It prevents the user from forgetting to set daylight saving time. In addition, it saves time and effort for the user.

Automatic clock adjustment

- 2) Time can be set for all controllers in a batch automatically.

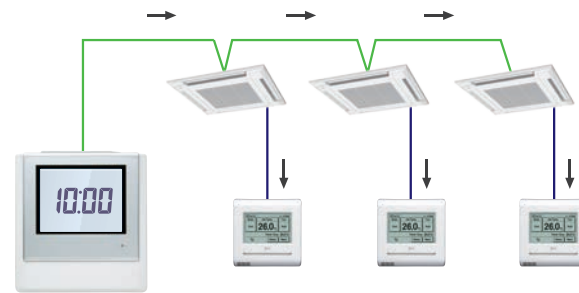

Outdoor unit low noise operation

You can choose from 4 low noise levels depending on the installation environment. ON/OFF timing of low noise mode can be set with the timer.

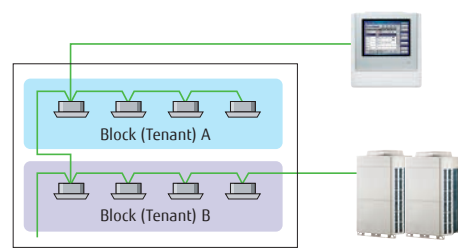

Quiet priority setting

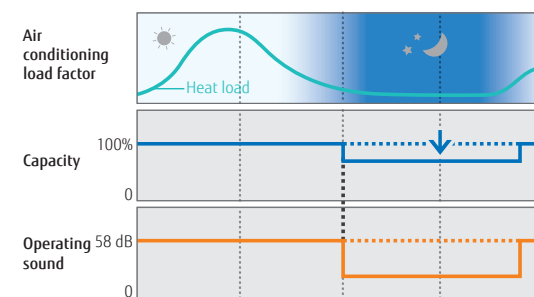

Energy-saving controls

Custom Auto

- Maintains 2 separate setpoints for heating and cooling operations.
- Automatically switches between heating and cooling modes.

* Not available for some models



Cooling set temp. 28°C, Heating set temp. 18°C

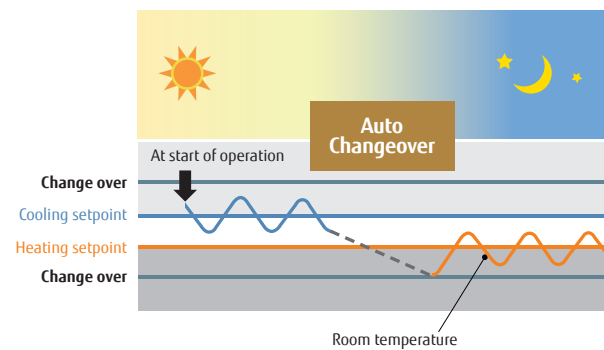

Refrigerant leak detector

Refrigerant leakage status is indicated by the management equipment. A pop-up message is displayed to notify the user, and the refrigerant is shut off.



Pop-up highlighting

FUNCTIONS SUMMARY

	UTY-DTGGZ1	Monitoring side
Air conditioning control functions		
ON/OFF	●	●
Operation mode setting*	●	●
Fan speed control	●	●
Room temperature setting	●	●
Setting temperature range limitation	●	●
Test operation	●	●
Vertical louver setting	●	●
Horizontal louver setting	●	●
Individual louver control	●*1	●
Group setting	●	●
Remote controller prohibition	●	●
Anti-freeze setting	●	●
Set temperature auto return	—	●
Energy-saving controls	—	●
Economy mode setting	●	●
Occupancy sensor control	—	●
Displayed items		
Error	●	●
Defrosting	●	●
Current time	●	●
Day of week	●	●
Remote controller prohibition	●	●
Cooling/heating priority	●	●
Address display	●	●
Room temperature	●*3	●*3
Multiple language support	●	●
Setting for daylight saving time	●	●
Time zone setting	●	●
Name registration	●	●
Backlighting	●	●
Language setting	7	7+ other
Filter sign reset	●	●
Memory operations	●	●
Refrigerant leak detector	●	●

●: Supported ○: Optional function —: Not supported
 *1 Only setting cancellation can be operated.
 *2 Only available for external input control.
 *3 Available only when using a Wired remote controller.

Specifications

	UTY-DTGGZ1
Model name	UTY-DTGGZ1
Power supply	Single phase ~100 to 240 V 50/60 Hz
Dimensions (H × W × D) (mm)	260 × 246 × 54
Weight (g)	2,150
Interfaces	Transmission/LAN/USB/EXT IN/EXT OUT/Reset SW

	UTY-DTGGZ1	Monitoring side	
Timer			
	Period	Year	Year
Schedule timer	ON/OFF, Temp, Mode, Times per day	20	20
ON/OFF timer		—	—
Sleep timer		—	—
Program timer		—	—
Auto-off timer		—	●
Day off		●	●
Minimum unit of timer setting (minutes)		10	10
Control			
Remote monitoring management system		●	●
Electricity charge apportionment		○	○
Error history		●	●
Emergency stop		●*2	●*2
Remote monitoring management		—	●
Energy-saving management		—	—
E-mail notification in case of failure		—	●
Key lock		● Password setting	—
Low noise mode		●	●

System controller

UTY-APGXZ1 **Software**

Up to
4 VRF network systems
Up to
400 outdoor units
Up to
1,600 indoor units

System controller enables advanced integrated monitoring and control of VRF network systems operating in small to large buildings.

- Up to 1,600 indoor units and 400 outdoor units on up to 4 VRF network systems can be controlled.
- To accommodate facility management needs, the system controller offers—in addition to precise air conditioning control—remote central control, electricity charge apportionment, schedule management, and energy-saving options for VRF network systems.
- Supports 7 languages: Chinese, English, French, German, Polish, Russian, and Spanish.



System controller Lite

UTY-ALGXZ1 **Software**

Up to
1 VRF network systems
Up to
100 outdoor units
Up to
400 indoor units

System controller Lite offers a set of standard functions to manage air conditioners operating in a small or midsize building.

- Up to 400 indoor units and 100 outdoor units on a VRF network system can be controlled.
- In addition to precise air conditioning control, a variety of applications are available as options to offer a wider range of control.
- Supports 7 languages: Chinese, English, French, German, Polish, Russian, and Spanish.



Visually intuitive operation

Click & Operate: The visual representation of the property is shown on the screen from the perspective most suitable for operation (Click & Operate) You can select from among 4 display options: site, building, floor, and list.

Freely define groups for batched control: Indoor units can be grouped for simplified batch control from the tree menu. They can be grouped by organizational hierarchy, such as by division, department, and section.

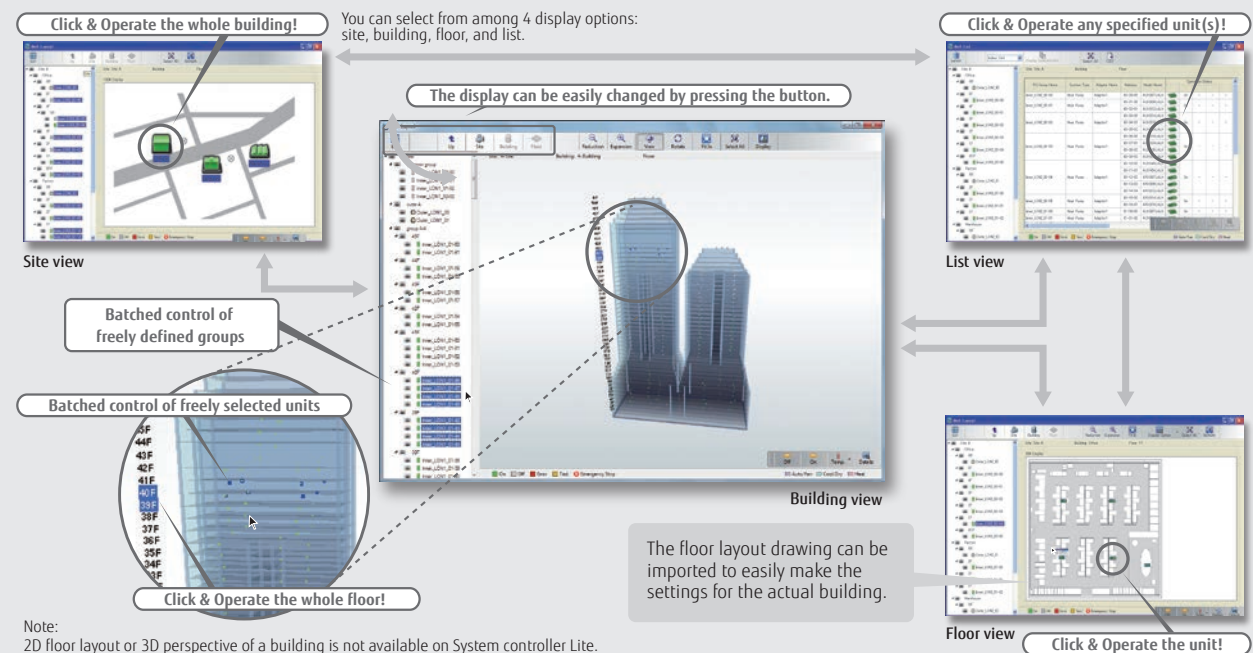

Features:

Third-party devices connected via MODBUS® can be controlled.

Standard for System Controller **Option** for System controller Lite UTY-PLGXX2

When a MODBUS® adapter (locally available) is connected to a computer, electrical equipment and devices supported by MODBUS® can be monitored and controlled centrally from the computer. The central control can reduce wasted energy throughout an entire building resulting from a failure to turn equipment off during or after work, as well as reduce the need for on-site patrols.

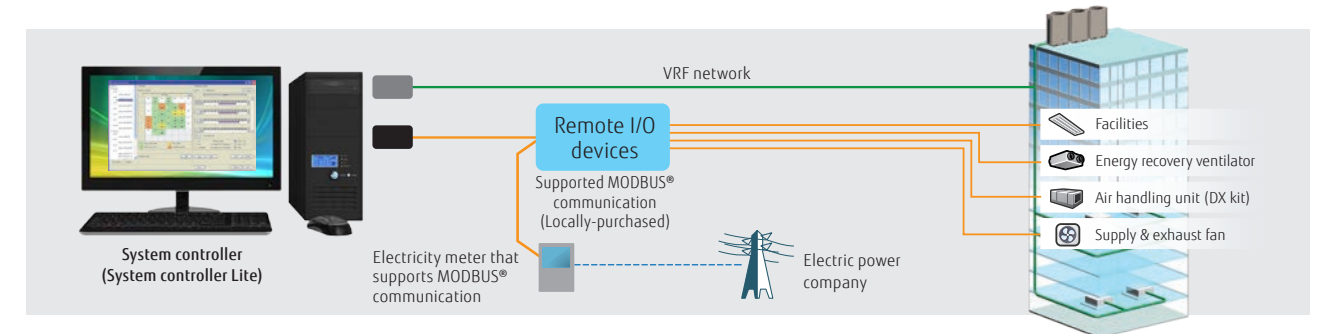

Wide-ranging operation and data management

Standard System controller and System controller Lite

Schedule management

- An annual schedule can be arranged for each remote controller group or user-defined group.
- ON/OFF, operation mode, remote controller prohibition, and temperature settings can be programmed for up to 143 times per day at 10-minute intervals and for up to 101 configurations for each remote controller group.
- Settings can be programmed for a period that spans midnight.
- Allows for the programming of special settings for weekends, holidays, and store closings throughout the year.
- Low noise operation of outdoor units can be scheduled.

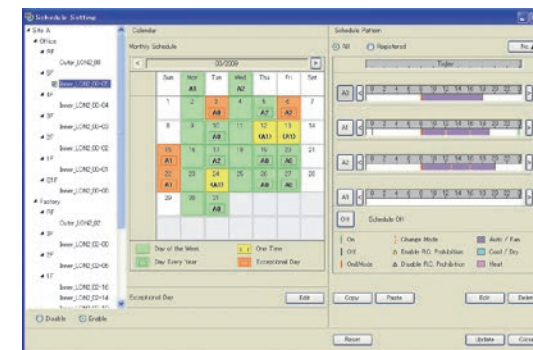

Wide-ranging control of indoor and outdoor units

- The operation status and mode of each indoor unit are displayed.
- Turn on and off each indoor unit and switch its operation mode.
- Setting temperature range limitation
- Low noise setting of outdoor units

Remote controller prohibition

Prohibits the operation mode, temperature setting, or ON/OFF of an indoor unit.

Error alert and e-mail notice

When something goes wrong, an error message is shown in a popup on a computer display with a chime, and an e-mail notice is sent. Errors of the past one year are logged and can be reviewed.

Operation and control history

A history of operation status and control can be maintained and retrieved.

Importing and exporting databases

Only an administrator is authorized to import and export registration, layout, and image data.

Automatic clock adjustment

Time can be set for all controllers in batch automatically.

Electricity charge apportionment

Standard on System controller
Option System controller Lite UTY-PLGXA2

Electricity charge apportionment method

This is a method to calculate monthly energy costs to be allocated to each tenant based on the amount of energy used by their air conditioners. The first step is to determine exactly how much energy is consumed by air conditioners in each tenant space. The second step is to divide the total energy charge billed by an electric power company based on the amount of energy used by each tenant to determine the energy cost to be allocated to each of them. (See figure on right) The calculation takes into consideration such factors as the number of unused rooms and nighttime electricity rate, which are shown in detail on an energy cost allocation schedule.

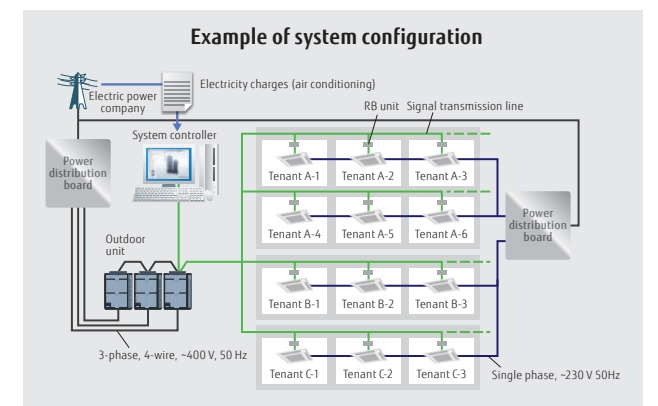

Features:

Remote monitoring management

- Standard on System controller
- Option System controller Lite UTY-PLGXR2

The System controller can be used on site or remotely over networks for remote central control. The System controller requires 2 software programs working together: The VRF controller runs on site and communicates with the VRF system; The VRF explorer, which runs at a remote location, provides a user interface and communicates with the VRF controller. The VRF controller and the VRF explorer run on a single computer or on different computers connected on a network. A computer running VRF explorer can centrally control up to 10 VRF system sites having up to 20 buildings each.

On site central control

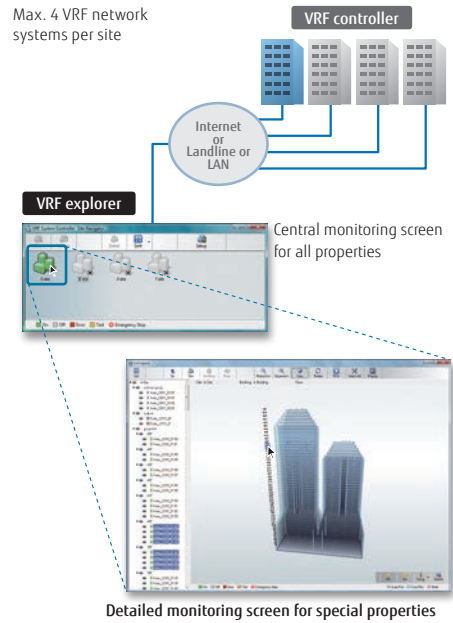

Remote central control

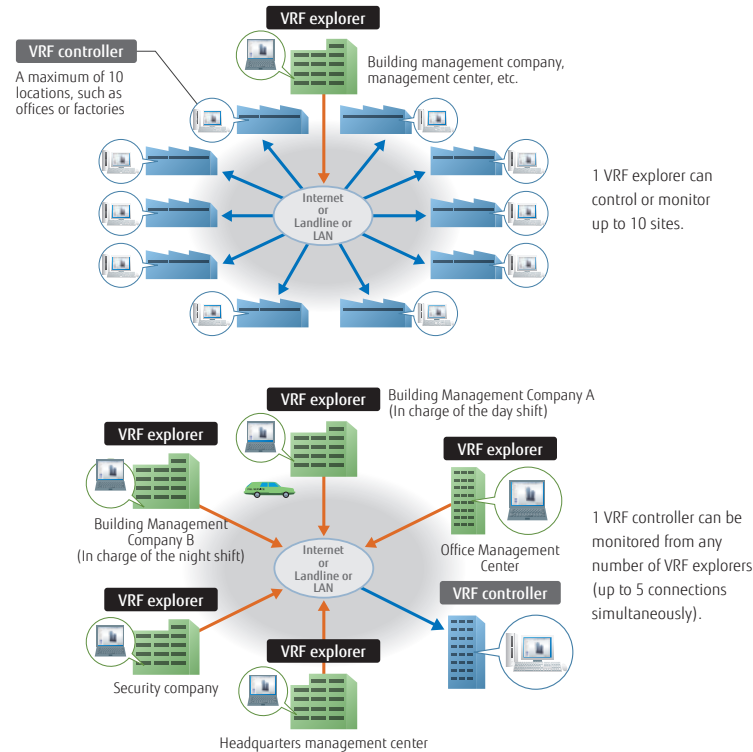

Energy-saving management

- Option System controller UTY-PEGXZ1
- Option System controller Lite UTY-PLGXE2

A variety of energy-saving options can be selected depending on the season, weather, and time of day. Excellent energy-saving operation is performed while keeping users comfortable.

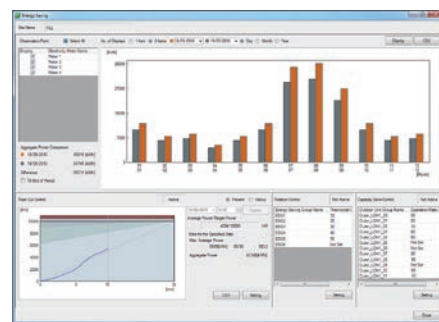

Main screen for energy-saving management

Energy saving graph data: This chart compares the energy consumption for the current month with the previous month and with the same month of the previous year to keep track of the energy-saving performance.

Indoor unit rotation

Indoor units can be automatically rotated to operate within a group in accordance with a predetermined annual schedule to reduce power consumption while keeping users comfortable. The operation stoppage rate can be selected for an indoor unit.

Peak-cut mode

The system controller monitors the connected power meter and controls the energy to maintain the target power consumption set for each time period by changing the set temperature of the indoor units or turning off the thermostat so as to keep the users comfortable. Indoor units to be controlled can be grouped in many ways, and the control level can be set for each group.

Capacity saving for outdoor unit

The upper limit on the capacity of an outdoor unit can be adjusted to reduce power consumption during a hot summer or cold winter by averaging out the power-saving performance of each refrigerant system. The upper limit on capacity can be set at 50% of the rated capacity or more.

Summary of functions

Functions	Type	System controller		System controller Lite				
		UTY-APGXZ1	Option UTY-PEGXZ1	UTY-ALGXZ1	Option UTY-PLGXR2	Option UTY-PLGXA2	Option UTY-PLGXE2	Option UTY-PLGXX2
Specifications	Max. number of VRF networks supported	4	—	1	—	—	—	—
	Max. number of indoor unit and remote controller groups per VRF network	400	—	400	—	—	—	—
	Max. number of outdoor units per VRF network	100	—	100	—	—	—	—
	Max. number of indoor units and remote controller groups per System controller	1600	—	400	—	—	—	—
Site supervision	Multiple site display	10	—	10	—	—	—	—
	Number of buildings per site	20	—	—	—	—	—	—
	Number of floors per site	200	—	—	—	—	—	—
	Number of floors per building	50	—	—	—	—	—	—
	3D graphical layout view	●	—	—	—	—	—	—
	2D graphical layout view	●	—	—	—	—	—	—
	List display	●	—	●	—	—	—	—
Error management	Error notification	●	—	●	—	—	—	—
	Audible alarm	●	—	●	—	—	—	—
	E-mail notification of errors	●	—	●	—	—	—	—
History	Error history	●	—	●	—	—	—	—
	Operation history	●	—	●	—	—	—	—
Operation control	Individual control	ON/OFF	●	—	●	—	—	—
		Operation mode*	●	—	●	—	—	—
		Room temperature	●	—	●	—	—	—
	Individual management	Fan speed	●	—	●	—	—	—
		Airflow direction	●	—	●	—	—	—
		Economy mode	●	—	●	—	—	—
		Setting temperature range limitation	●	—	●	—	—	—
		Anti-freeze	●	—	●	—	—	—
		Low noise setting of outdoor units	●	—	●	—	—	—
	Other	Remote controller prohibition	●	—	●	—	—	—
		Setting temperature range limitation	●	—	●	—	—	—
		Filter sign reset	●	—	●	—	—	—
	Schedule	Annual Schedule	Annual Schedule	●	—	●	—	—
Setting for a specific date			●	—	●	—	—	—
ON/OFF per day		ON/OFF per day	72	—	72	—	—	—
		ON/OFF per week	504	—	504	—	—	—
Day off		Day off	●	—	●	—	—	—
		Minimum unit of timer setting (minutes)	10	—	10	—	—	—
Weekly schedule for low noise mode		●	—	●	—	—	—	
Remote monitoring management		Web Operation	●	—	●	—	—	—
		Remote monitoring	●	—	●	—	—	—
		Remote operation control	●	—	●	—	—	—
	Remote function setting	●	—	●	—	—	—	
Electricity charge apportionment	Apportionment charge/bill calculation	●	—	●	—	—	—	
	Tenant (block) setting	●	—	●	—	—	—	
	Common facilities apportionment setting	●	—	●	—	—	—	
	Rated power consumption allotment setting	●	—	●	—	—	—	
Energy-saving management	Indoor unit rotation	Indoor unit rotation	—	●	—	—	—	
		Peak cut control	—	●	—	—	—	
	Capacity saving for outdoor unit	Capacity saving for outdoor unit	—	●	—	—	—	
		Record of energy-saving operation	—	●	—	—	—	
	Information on energy saving	Information on energy saving	—	●	—	—	—	
		Power consumption monitor	—	●	—	—	—	
Control of external devices	Monitor	●	—	●	—	—	—	
	Control	●	—	●	—	—	—	
Others	Importing and exporting databases	Importing and exporting databases	●	—	●	—	—	
		Automatic clock adjustment	●	—	●	—	—	
	Multiple language support	7 languages	—	7 languages	—	—		
	Refrigerant leak detector	●	—	●	—	—	—	
Power shutdown	●	—	●	—	—	—		

●: Available - : Not available

Computer requirements

The specifications required for the computer are shown in the table below:

	System controller	System controller Lite
Operating system	<ul style="list-style-type: none"> Microsoft® Windows® 7 Home Premium (32-bit or 64-bit) SP1, Windows® 7 Professional (32-bit or 64-bit) SP1 Microsoft® Windows® 8.1 (32-bit or 64-bit), Windows® 8.1 Pro (32-bit or 64-bit) Microsoft® Windows® 10 Home (32-bit or 64-bit), Windows® 10 Pro (32-bit or 64-bit) Supports 7 languages: English, Chinese, French, German, Russian, Spanish, and Polish	<ul style="list-style-type: none"> Microsoft® Windows® 7 Home Premium (32-bit or 64-bit) SP1, Windows® 7 Professional (32-bit or 64-bit) SP1 Microsoft® Windows® 8.1 (32-bit or 64-bit), Windows® 8.1 Pro (32-bit or 64-bit) Microsoft® Windows® 10 Home (32-bit or 64-bit), Windows® 10 Pro (32-bit or 64-bit) Supports 7 languages: English, Chinese, French, German, Russian, Spanish, and Polish
CPU	Intel® Core™ i3 2 GHz or higher	Intel® Core™ i3 2 GHz or higher
Memory	<ul style="list-style-type: none"> 2 GB or more (for Windows® 7 [32-bit]) 4 GB or more (for Windows® 7 [64-bit], Windows® 8.1, and Windows® 10) 	<ul style="list-style-type: none"> 2 GB or more (for Windows® 7 [32-bit]) 4 GB or more (for Windows® 7 [64-bit], Windows® 8.1, and Windows® 10)
HDD	40 GB or more of free space	40 GB or more of free space
Displayed items	1024 × 768 or higher resolution	1024 × 768 or higher resolution
Interfaces	<ul style="list-style-type: none"> Ethernet port (for getting access to the internet using LAN) or a modem (for getting access to the internet via landline) Up to 6 USB ports (Only required for a server computer working as a VRF controller) - Maximum of 2 USB ports are required to connect to a White-USB-key/WibuKey - Up to 4 USB ports required to connect to an Echelon® U10 USB network interface * Maximum number of required USB ports depends on the applicable system configuration. 	<ul style="list-style-type: none"> Ethernet port (for getting access to the internet using LAN) or a modem (for getting access to the internet via landline) Up to 6 USB ports (Only required for a server computer working as a VRF controller) - Maximum of 4 USB ports are required to connect to a White-USB-key/WibuKey - 1 USB port is required for an Echelon® U10 USB Network interface * The maximum number of required USB ports depends on the applicable system configuration.
Graphic accelerator	Microsoft® DirectX® 9.0c compatible	Microsoft® DirectX® 9.0c compatible
Software	Adobe® Acrobat Reader® 9.0 or later	Adobe® Acrobat Reader® 9.0 or later

* Echelon® U10 USB Network interface - TP/FT-10 Channel (Model name: 75010R) (Required for each VRF Network)

Packing list

Type	For System controller			For System controller Lite			
	System controller	Option Energy manager	System controller Lite	Remote access	Electricity charge apportionment	Energy saving	Centralized control
Model name	UTY-APGXZ1	UTY-PEGXZ1	UTY-ALGXZ1	UTY-PLGXR2	UTY-PLGXA2	UTY-PLGXE2	UTY-PLGXX2
White-USB-key	1	1	1	1	1	1	1

*1: Software protection key to be inserted in a USB slot running System controller or System controller Lite. System controller or System controller Lite may only run on a PC with a WHITE-USB-KEY. However, a WHITE-USB-KEY is not required for remote VRF explorer software.

MODBUS® converter for Indoor unit

UTY-VMSX



Up to
1 indoor unit

MODBUS® converter enables air conditioners to be fully integrated into a MODBUS® network.

- Simple installation due to small and compact size.
- No separate external power supply required.
- The MODBUS® converter must be connected to an indoor unit on a one-to-one basis.
- The MODBUS® converter enables central monitoring and control of air conditioners from BMS, central, or home controller.

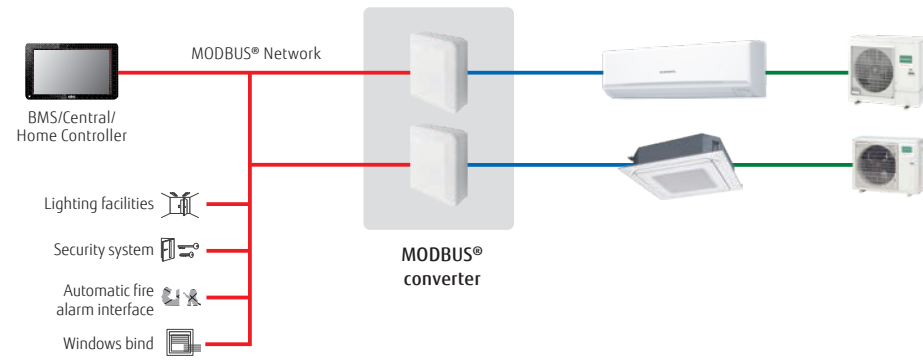

Easy Installation

Easy to install with minimal wiring and without the need for a power supply cable to the converter

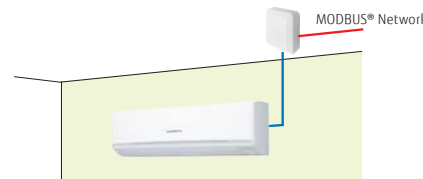

Basic control

- Turning the units on and off
- Mode control (Heat, Cool, Dry, Auto, Fan)
- Fan speed control
- Louver position (airflow direction setting)
- Room temperature setting and display
- Economy mode setting
- Error status

Specifications

Model name	UTY-VMSX
Power supply	12 V DC
Input power (W)	Max. 1.2 W
Dimensions (H × W × D) (mm)	140 × 117 × 43
Weight (g)	200
Maximum number of connectable indoor units per MODBUS® converter	1

Modbus communication specifications

Transfer mode	RTU mode
Communication speed	9600/19200 bps
Data bit	8
Parity	even/odd/none
Stop bit	1/2 (no parity)
Network	RS485
Maximum cable length	1000 m (3280 ft)

MODBUS® interface

FG-RC-MBS1Z1 / FG-AC-MBS1Z1 / FG-IR-BMG1Z1



FG-RC-MBS1Z1
(3-wire RC-line type)



FG-AC-MBS1Z1
(CN connector type)



Up to
1 indoor unit

MODBUS® interface enables air conditioners to be fully integrated into a MODBUS® network.

- Small, compact, and easy to install on DIN rails.
- No separate external power supply required.
- MODBUS® interface enables central monitoring and control of air conditioners from BMS.

Installation example

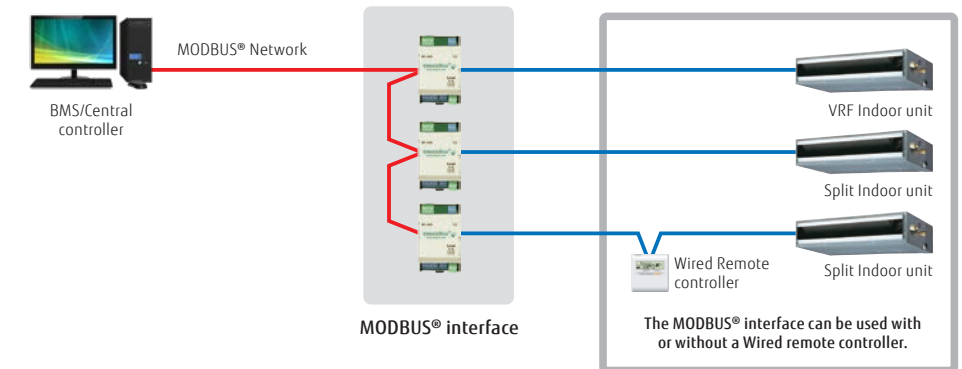

The MODBUS® interface can be used with or without a Wired remote controller.

[IR type] Connection to wall-mounted type

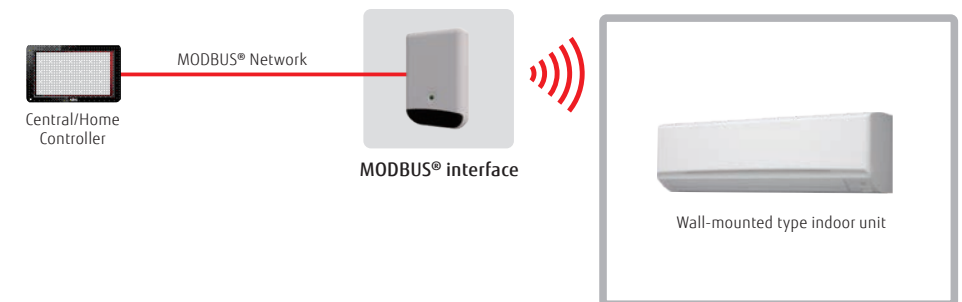

Specifications

Model name	FG-RC-MBS1Z1 (3-wire RC-line type)	FG-AC-MBS1Z1 (CN connector type)	FG-IR-BMG1Z1 (IR type)
Number of controllable groups	1	1	1
Dimensions (H × W × D) (mm)	93 × 53 × 58	93 × 53 × 58	93 × 60 × 21
Weight (g)	85	85	55

MODBUS® convertor for VRF

UTY-VMGX / FG-TL-MBS16Z1

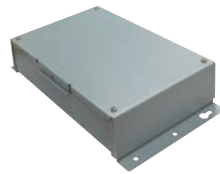

UTY-VMGX

Up to
9 units per VRF system
Up to
100 outdoor units
Up to
128 indoor units

MODBUS® convertor enables air conditioners to be fully integrated into a MODBUS® network.

- Compact and lightweight design
- Direct connection to MODBUS® network
- MODBUS® convertor enables central monitoring and control of air conditioners from BMS or a central controller.
- Up to 9 converters can be connected to a VRF network (UTY-VMGX). Simultaneous control, such as Power ON/ OFF and temperature setting, can be performed for each zone.
- If a connection error occurs after installation work is completed, the source of the error can be located easily.

Installation example



FG-TL-MBS16Z1

Up to
16 indoor units
Up to
16 outdoor units
Up to
128 indoor units

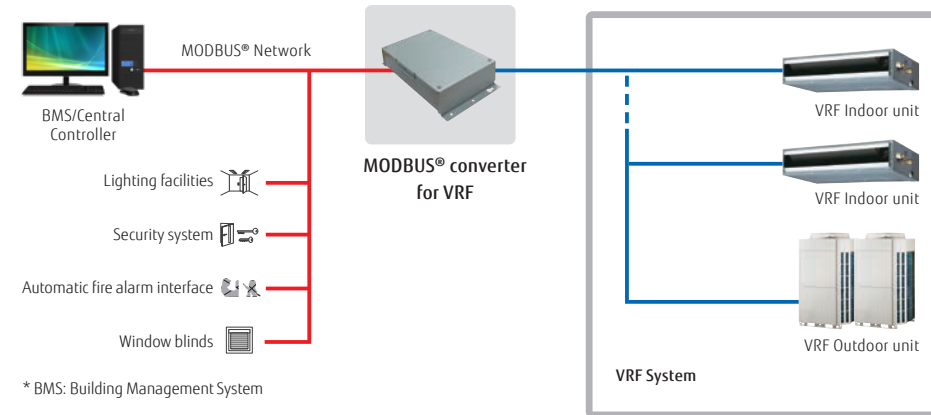

* BMS: Building Management System

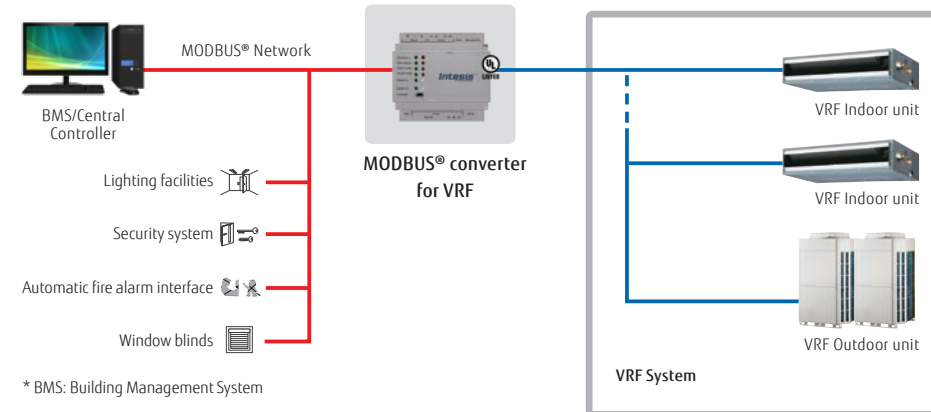

* BMS: Building Management System

Specifications

Model name	UTY-VMGX	FG-TL-MBS16Z1
Power supply	Single phase ~220 to 240 V 50/60 Hz	9 to 36 V DC, Max.: 140 mA or 24 V AC 50/60 Hz, Max.: 127 mA.*
Input power (W)	Max. 2	1.7
Dimensions (H × W × D) (mm)	54 × 260 × 150	90 × 88 × 56
Weight (g)	1,100	330

*24 V DC power supply is recommended.

BACnet® interface

FG-AC-BAC1Z1 / FG-IR-BMG1Z1



FG-AC-BAC1Z1 (CN connector type)



FG-IR-BMG1Z1 (IR type)

NEW

Up to
1 indoor units

- BACnet® interface connects BMS and a Fujitsu General split/multi-split/VRF system.
- Compatible with BACnet® (ANSI/ASHRAE-135-2012) application-specific controller (B-ASC)
- Compatible with BACnet®/IP over Ethernet.

Installation example

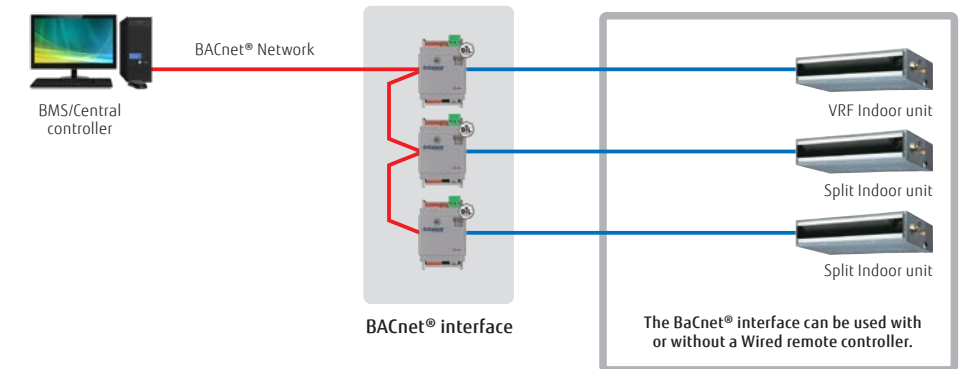

The BACnet® interface can be used with or without a Wired remote controller.

[IR type] Connection to wall-mounted type

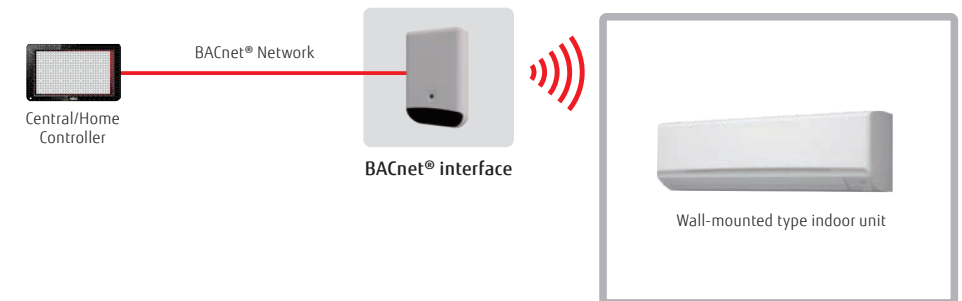

Specifications

Model name	FG-AC-BAC1Z1 (CN connector type)	FG-IR-BMG1Z1 (IR type)
Number of controllable groups	1	1
Dimensions (H × W × D) (mm)	93 × 53 × 58	93 × 60 × 21
Weight (g)	85	55

12 V DC supplied by an indoor unit

BACnet® gateway

UTY-ABGXZ1 (Software)



White-USB-key
(Software Protection Key)



BACnet® is a registered trademark of ASHRAE. ASHRAE does not endorse, approve or test products for compliance with ASHRAE standards. Compliance of listed products to the requirements of ASHRAE Standard 135 is the responsibility of BACnet International (BI). BTL is a registered trademark of BACnet International.

Up to
4 VRF network systems
Up to
400 outdoor units
Up to
1,600 indoor units

Installation example

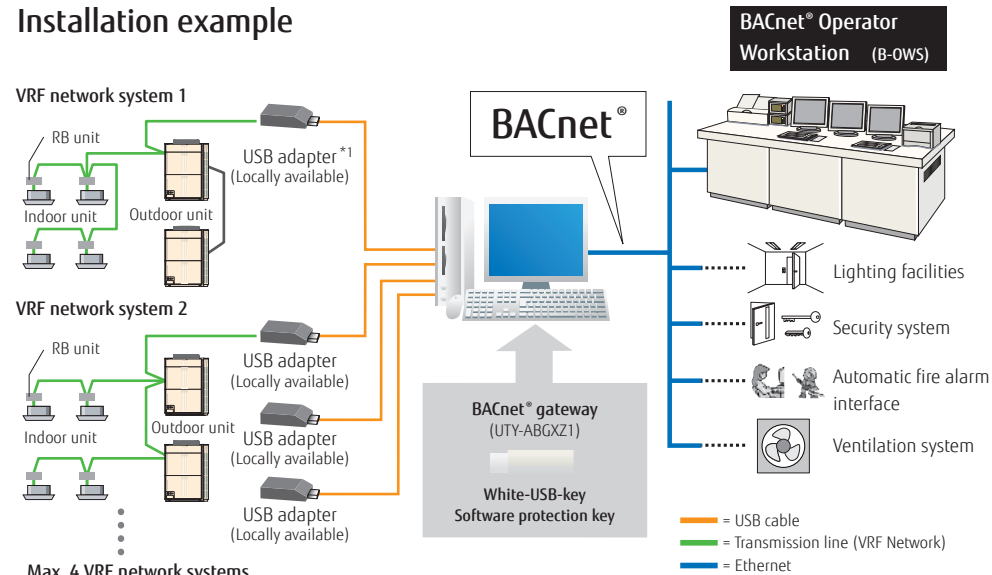

*1: U10 USB network interface available from Echelon® Corporation.

Computer requirements

	UTY-ABGXZ1
Operating system	<ul style="list-style-type: none"> Microsoft® Windows® 7 Home Premium (32-bit or 64-bit) SP1, Windows® 7 Professional (32-bit or 64-bit) SP1 Microsoft® Windows® 8.1 (32-bit or 64-bit), Windows® 8.1 Pro (32-bit or 64-bit) Microsoft® Windows® 10 Home (32-bit or 64-bit), Windows® 10 Pro (32-bit or 64-bit) Supported languages: Chinese, English, French, German, Polish, Russian, and Spanish
CPU	Intel® Core™ i3 2 GHz or higher
Memory	<ul style="list-style-type: none"> 2 GB or more (for Windows® 7 [32-bit]) 4 GB or more (for Windows® 7 [64-bit], Windows® 8.1, and Windows® 10)
HDD	40 GB or more of free space
Displayed items	1024 × 768 or higher resolution
Interfaces	<ul style="list-style-type: none"> Ethernet port (for getting access to the internet using LAN) Up to 5 USB ports - 1 USB port required to connect to a White-USB-key/WibuKey - Up to 4 USB ports required to connect to an Echelon® U10 USB network interface *The maximum number of required USB ports varies depending on the applicable system configuration.
Software	Adobe® Acrobat Reader® 9.0 or later

*Echelon® U10 USB Network interface – TP/FT-10 Channel (Model name: 75010R) (Required for each VRF Network)

Packing list

Name and shape	Quantity	Application
White-USB-key	1	Includes the software, user's manual, and license for BACnet® gateway.

BACnet® gateway

UTY-VBGX (Hardware)



BACnet® is a registered trademark of ASHRAE. ASHRAE does not endorse, approve or test products for compliance with ASHRAE standards. Compliance of listed products to the requirements of ASHRAE Standard 135 is the responsibility of BACnet International (BI). BTL is a registered trademark of BACnet International.

Up to
1 VRF network systems
Up to
32 refrigerant systems
Up to
128 indoor units

Installation example

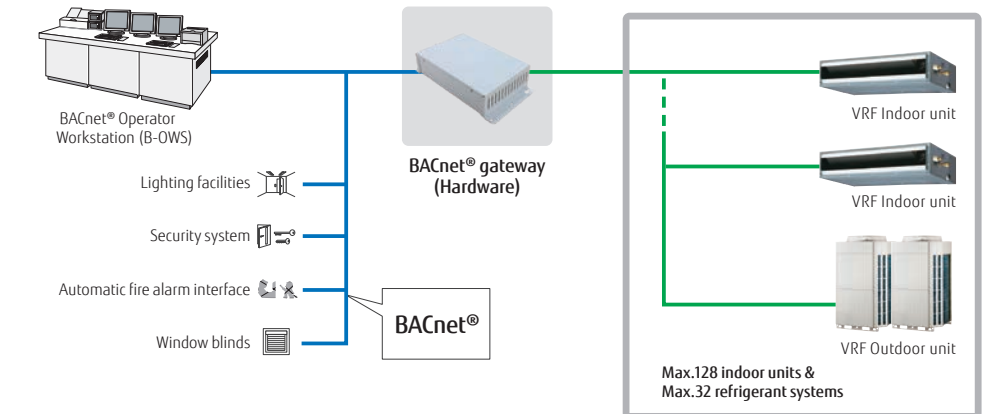

Max.128 indoor units & Max.32 refrigerant systems

Specifications

Model name	UTY-VBGX
Number of controllable indoor units	128
Number of controllable refrigerant systems	32
Number of controllable VRF networks	1
Number of connectable units / one VRF network	4
Power supply	Single phase, 100-240 V, 50/60 Hz
Power consumption (W)	4.6 (max.)
Dimensions (H × W × D) (mm)	59.6 × 270.4 × 176
Weight (g)	1200

BACnet®/MODBUS® Router

FG-RTR-BAC32Z1 / FG-RTR-MBS32Z1



FG-RTR-BAC32Z1 (BAC net)



FG-RTR-MBS32Z1 (MODBUS®)

Routing between BaCnet® MS/TP and BaCnet® IP networks

- Routing between BaCnet® MS/TP and BaCnet® IP networks
- Routing between MODBUS® RTU and MODBUS® TCP networks

Installation example

[BaCnet® type]

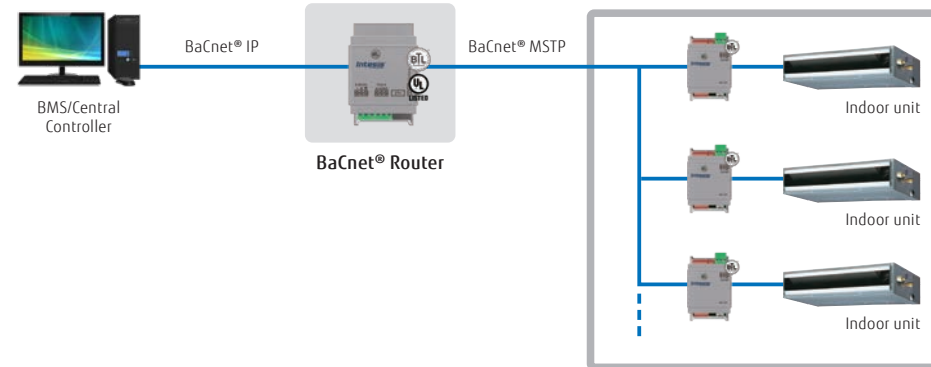

[MODBUS® type]

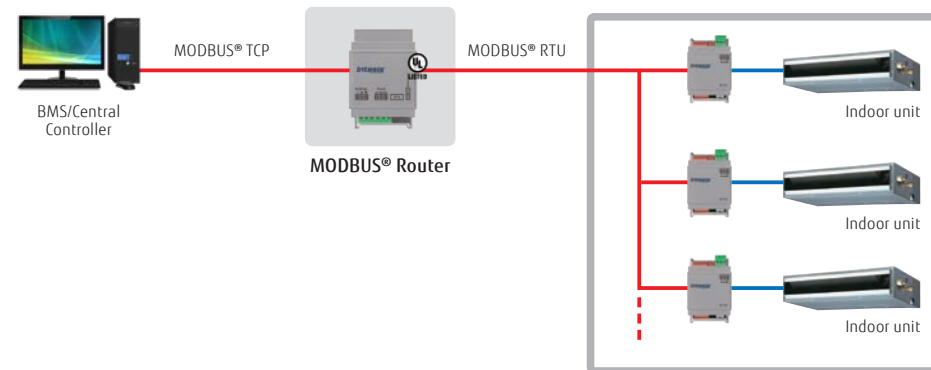

Specifications

Model name	FG-RTR-BAC32Z1 (MS/TP to IP)	FG-RTR-MBS32Z1 (RTU to TCP)
Number of routable devices (max.)	32	32
Power supply	9 to 36 V DC, Max.: 140 mA or 24 V AC 50/60 Hz, Max.: 127 mA	9 to 36 V DC, Max.: 140 mA or 24 V AC 50/60 Hz, Max.: 127 mA
Power consumption (W)	1.7	1.7
Dimensions (H × W × D) (mm)	93 × 53 × 58	93 × 53 × 58
Weight (g)	150	150

BACnet®/MODBUS® Cloud Device

FG-CLD-BMG4Z1 / FG-CLD-BMG8Z1 / FG-CLD-BMG16Z1 / FG-CLD-BMG32Z1



FG-CLD-BMG4Z1

- The most powerful configuration tool common to all BACnet® gateways provides the system integrators with the power to configure and monitor their systems in an easy and reliable manner.
- A simple, easy-to-use description for the ST Cloud Web and App User Interface, with all widgets customizable to the user's needs, enabling system integrators to easily offer the best user experience to customers who are in control of their BaCnet® or MODBUS® devices.

Installation example

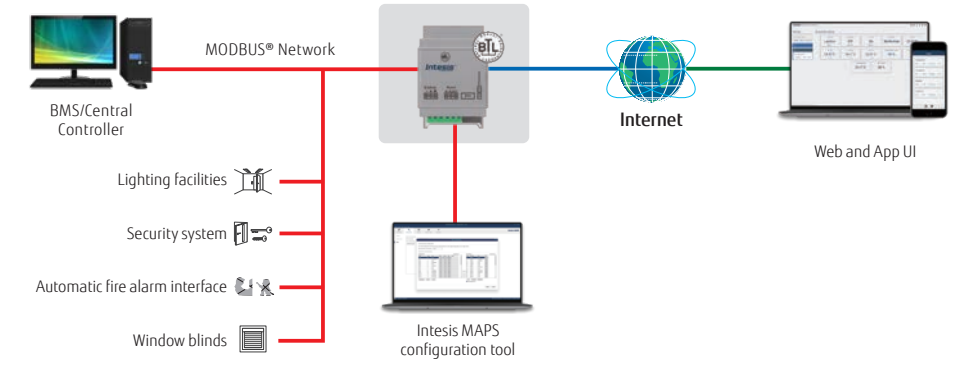

*BMS: Building Management System

Gateway features

- BaCnet® IP/MSTP or MODBUS® TCP/RTU connectivity
- Up to 32 devices can be connected to each gateway.
- Up to 12 widgets per device
- Easy device configuration with Intesis MAPS

Next-generation services

- Industrial-grade connectivity now for building automation
- Fast and scalable real-time edge connectivity over HMS HubTM
- Full data control and protection
- Secure and remote updates during the application lifetime

System Features

- Monitor and control all devices in an intuitive way
- Comes with a native iOS and Android app and a web interface
- Create scenes and interact with multiple concurrent devices
- Calendar that shows the daily planned installation commands
- Notifications keep you updated about system status
- Device sharing and usage permissions management
- Multiple site management from a common dashboard

Specifications

Model name	FG-CLD-BMG4Z1	FG-CLD-BMG8Z1	FG-CLD-BMG16Z1	FG-CLD-BMG32Z1
Number of connectable BaCnet® (IP/MSTP) or MODBUS® (TCP/RTU) devices	4	8	16	32
Power supply	9 to 24 V DC, 50/60Hz	9 to 24 V DC, 50/60Hz	9 to 24 V DC, 50/60Hz	9 to 24 V DC, 50/60Hz
Power consumption (W)	1.7	1.7	1.7	1.7
Dimensions (H × W × D) (mm)	93 × 53 × 58	93 × 53 × 58	93 × 53 × 58	93 × 53 × 58
Weight (g)	150	150	150	150

KNX® converter for indoor unit

UTY-VKSX



Up to
1 indoor unit

KNX® Converter enables individual control of an indoor unit.

- The new KNX® converter connects a central or home controller and a Fujitsu General indoor unit.
- Compact and lightweight design

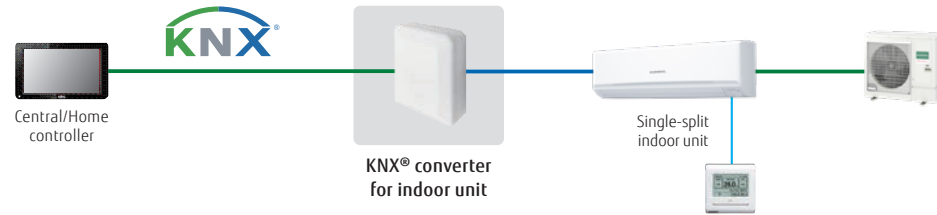

KNX® converter for VRF

UTY-VKGX / FG-TL-KNX16Z1

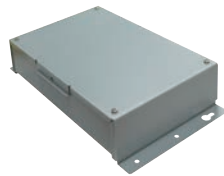

UTY-VKGX

Up to
100 outdoor units
Up to
128 indoor units



FG-TL-KNX16Z1

Up to
16 indoor units
Up to
16 outdoor units

KNX® converter enables centralized control of a system.

- KNX® converter connects a central or home controller and a Fujitsu General VRF system.
- Up to 128 indoor units and 100 outdoor units can be connected to a single KNX® converter. (UTY-VKGX)

Installation example

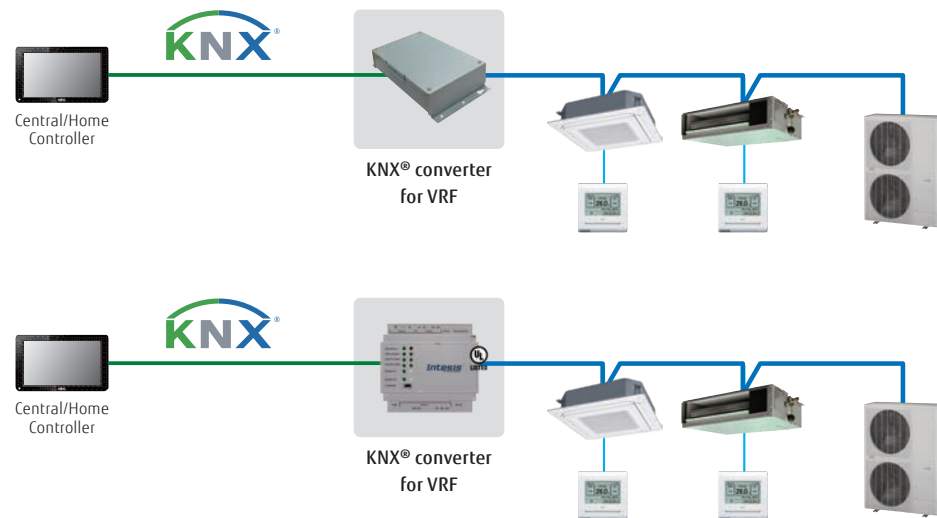

Specifications

Model name	UTY-VKSX	UTY-VKGX	FG-TL-KNX16Z1
Power supply	12 V DC	Single phase ~220 to 240 V 50/60 Hz	9 to 36 V DC, Max.: 140 mA or 24 V AC 50/60 Hz, Max.: 127 mA.*
Input power (W)	0.6	1.5	1.6
Dimensions (H × W × D) (mm)	140 × 117 × 43	54 × 260 × 150	90 × 88 × 56
Weight (g)	215	1,200	340

*24 V DC power supply is recommended.

KNX® interface

FG-RC-KNX1Z1 / FG-AC-KNX1Z1 / FG-IR-KNX1Z1



Intesis®



FG-RC-KNX1Z1
(3-wire RC-line type)

Intesis®



FG-AC-KNX1Z1
(CN connector type)

Intesis®



FG-IR-KNX1Z1
(IR type)

Up to
1 indoor unit

The KNX® interface enables air conditioners to be fully integrated into a KNX® network system.

- Simple installation due to small and compact size.
- No separate external power supply required (only KNX® bus power required)

Installation example

[3-wire RC-line type/CN connector type]

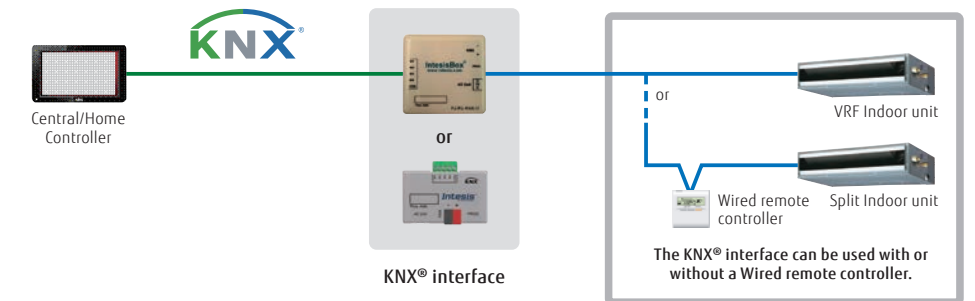

[IR type] Connection to wall-mounted type

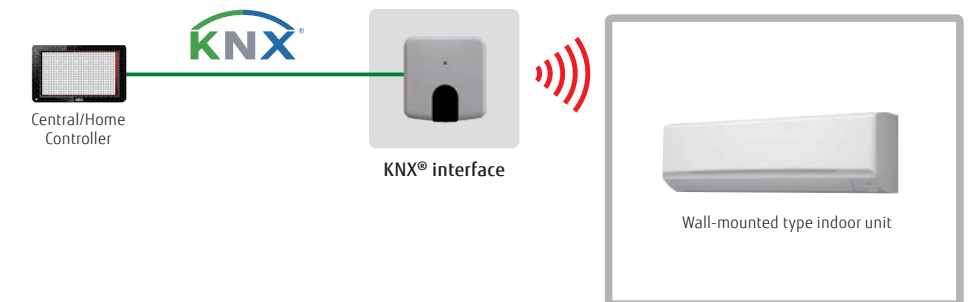

[IR type] Connection to a product other than wall-mounted type

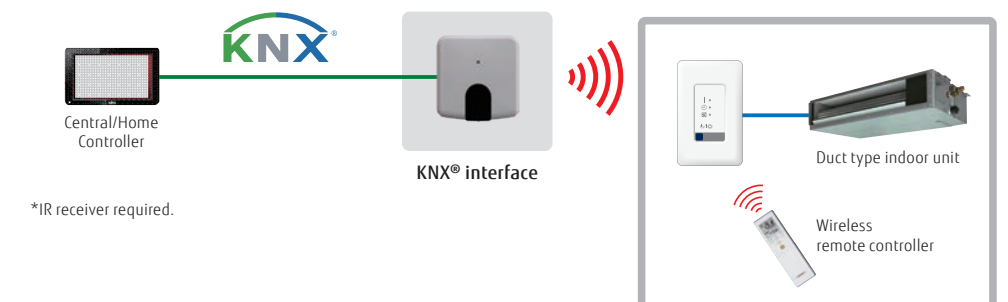

*IR receiver required.

Specifications

Model name	FG-RC-KNX1Z1 (3-wire RC-line type)	FG-AC-KNX1Z1 (CN connector type)	FG-IR-KNX1Z1 (IR type)
Number of controllable groups	1	1	1
Dimensions (H × W × D) (mm)	70 × 70 × 28	45 × 59 × 21	81 × 78 × 28
Weight (g)	70	35	76

Network converter for single-split type

UTY-VTGX / UTY-VTGXV



UTY-VTGX
DC power supply type

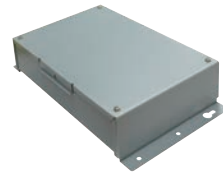

UTY-VTGXV
AC power supply type

Up to
16 single indoor units
Up to
1 group
Up to
100 Network Converters

- A network converter is required when connecting a single-split system to a VRF network system.
- Compact and lightweight design
- Connectable to both nonpolar 2-core and polar 3-core remote controllers

Installation example

- A 1-remote-controller type and a 2-remote-controller type are available.
- Power supply (220 to 240 V AC, 50/60 Hz) is required for the 2-remote-controllers type.

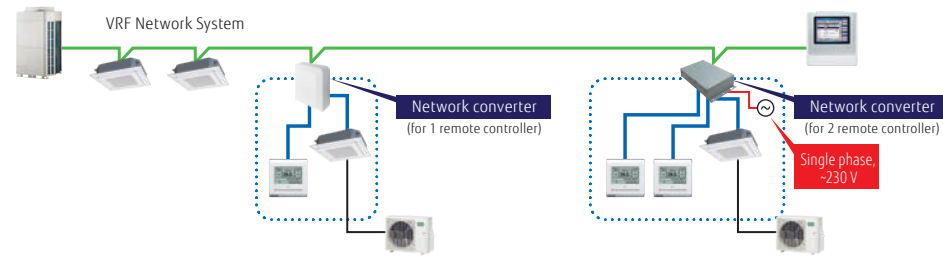

- Both nonpolar 2-core and polar 3-core type Wired remote controllers can be connected.

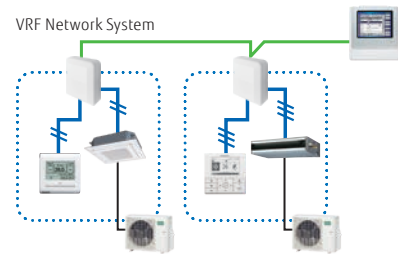

- Central control can be provided for single-split systems. (Up to 100 network converters can be connected in a VRF network system)

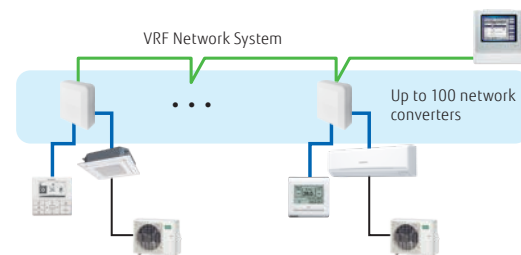

Specifications

Model name	UTY-VTGX		UTY-VTGXV
	Power supply	Polar 3-core 12 V DC	Nonpolar 2-core DC 12 V
Input power (W)	Max. 1.2 W		Max. 3
Dimensions (H × W × D) (mm)	140 × 117 × 43		54 × 260 × 150
Weight (g)	250		1,100

Network converter for LONWORKS™

UTY-VLGX

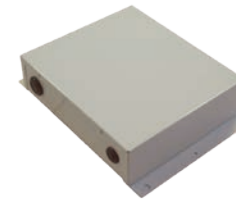

Up to
4 units to BMS
Up to
100 outdoor units
Up to
128 indoor units

- Connects the VRF network system to a LONWORKS™ open network to manage small and mid-sized BMS and VRF network system.
- The UTY-VLGX enables centralized monitoring and control of VRF network system from a BMS via a LONWORKS™ interface.
- Up to 128 Indoor units can be connected to one network converter for LONWORKS™

Installation example

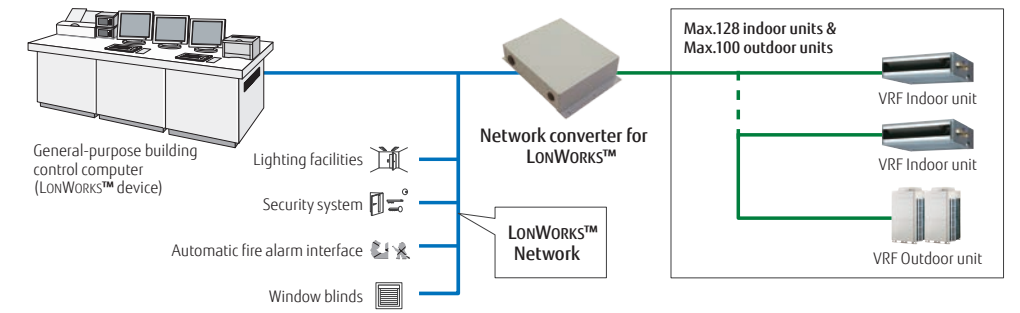

Specifications

Model name	UTY-VLGX
Power supply	Single phase ~208 to 240 V 50/60 Hz
Power consumption (W)	4.5
Dimensions (H × W × D) (mm)	67 × 288 × 211
Weight (g)	1,500

Transmission specifications (BMS side)

Transmission speed	78 kbps
Transceiver	FT-X1 (available from Echelon® Corporation)
Transmission line form	Free topology
Terminal resistor	None (converter to be attached at the terminal of a network)

External switch controller

UTY-TERX



Up to
1 group

Air conditioner switching can be controlled by connecting this external switch controller to other sensor switches.

- In combination with a commercially available card-key switch or other sensors, this External switch controller enables the control of ON/OFF, room temperature, and fan speed of connected air conditioners as well as master control functions. This makes this product an ideal choice for use in hotel rooms.
- Card key or other sensor switches are locally available.
- The set temperature can be specified at two points each for cooling and heating operations (4 points in total).

Installation example

Occupancy sensor monitors the movement of a person in a room. When it detects that the person has left the room, it switches the air conditioner to low-capacity mode. When a person returns to the room, the air conditioner returns to the previous operation mode.

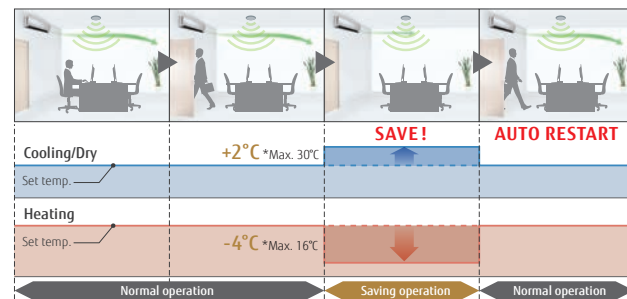

Occupancy sensor equipment needs to be purchased separately.
Occupancy sensor is not mounted on an External switch controller.

Signal amplifier

UTY-VSGXZ1

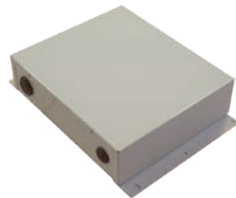

- The transmission line can be extended up to 3,600 m using multiple Signal amplifiers.
- Up to 8 Signal amplifiers can be added in a VRF network system.
- A Signal amplifier is required.
 - (1) When the total wiring length of the transmission line exceeds 500 m.
 - (2) When the total number of units on the transmission line exceeds 64.

Installation example

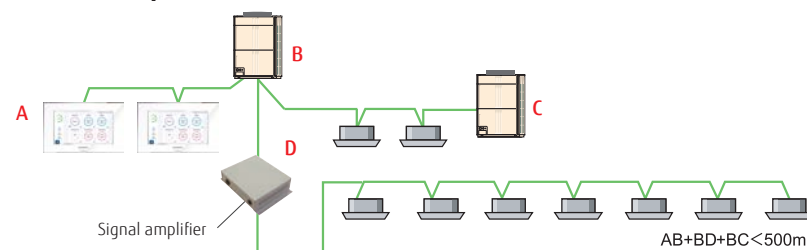

Specifications

Model name	UTY-VSGXZ1	UTY-TERX
Power supply	Single phase ~208 to 240 V 50/60 Hz	6.5 to 16 V DC
Power consumption (W)	4.5	-
Dimensions (H × W × D) (mm)	67 × 288 × 211	140 × 117 × 43
Weight (g)	1,500	250

12 V DC supplied by an indoor unit



Controller system list (available) for Split/Multi-split

Controller Options/Accessories:



Type	Refrigerant	Indoor unit														Indoor unit				Outdoor unit				
		Wall-mounted							Cassette		Duct		Duct			Floor	Ceiling	Multi-split			Single phase			
		Designer Series		Standard Series			ECO Series	Compact 4-way flow Series	Circular flow Series	Slim	Medium static pressure (High Efficiency & Comfort)	Medium static pressure (Compact)	Medium static pressure (Standard)	High static pressure		BIG			Wall-mounted	Compact cassette	Mini duct	Slim duct	5/6-unit multi-split	
		ASHG 07/09/12/14 KGTF, KGTE	ASHG 07/09/12/14 KETF, KETF-B, KETE, KETE-B	ASHG 07/09/12/14 KMCF, KMCE	ASHG 18/24KMTE	ASHH 30/36KMTB	ASHG 07/09/12 KPCE	AUXG 09/12/14/18/22/24 KVLA	AUXG 18/22/24/30/36/45/54 KRLB	ARXG 09/12/14/18 KLLAP	ARXH 22/24/30/36/45/54 KMTAP	ARXG 12/14/18/22/24/30/36/45/54 KHTAP	ARXG22KMLB, ARXG 24/30/36/45 KMLA	ARXG 45/54KHTB	ARHG 60LHTA	ARHG 72/90LHTA	AGHG 09/12/14 KVCA	ABHG 18/22/24/30/36/45/54 KR1A	ASHG 22KMTE	AUXG 07KVLA	ARXG 07/09/12/14/18 KSLAP	ARXG 07KLLAP	AOHG36KBTA5	
																							AOHG45LBA6	
Wired remote controller		● UTY-RNRGZ5+ UTY-TWRXZ2							● UTY-RNRGZ5			● UTY-RNRGZ5				● UTY-RNRGZ5	● UTY-RNRGZ5+ UTY-TWRXZ3	● UTY-RNRGZ5	● UTY-RNRGZ5+ UTY-TWRXZ2			● UTY-RNRGZ5		
		● UTY-RLRG+ UTY-TWRXZ2							● UTY-RLRG			● UTY-RLRG				● UTY-RLRG	● UTY-RLRG+ UTY-TWRXZ3	● UTY-RLRG	● UTY-RLRG+ UTY-TWRXZ2			● UTY-RLRG		
		● UTY-RCRGZ1+ UTY-TWRXZ2							● UTY-RCRGZ1			● UTY-RCRGZ1				● UTY-RCRGZ1	● UTY-RCRGZ1+ UTY-TWRXZ3	● UTY-RCRGZ1	● UTY-RCRGZ1+ UTY-TWRXZ2			● UTY-RCRGZ1		
								● UTY-RVNGM			● UTY-RVNGM			● UTY-RVNGM								● UTY-RVNGM		
								● UTY-RNNGM			● UTY-RNNGM			● UTY-RNNGM								● UTY-RNNGM		
Simple remote controller		● UTY-RSRG UTY-RHRG+ UTY-TWRXZ2							● UTY-RSRG, UTY-RHRG, UTY-RSNGM		● UTY-RSRG UTY-RHRG		● UTY-RSRG, UTY-RHRG, UTY-RSNGM	● UTY-RSRG UTY-RHRG	● UTY-RSNGM	● UTY-RSRG UTY-RHRG UTY-RSNGM	● UTY-RSRG UTY-RHRG+ UTY-TWRXZ3	● UTY-RSRG UTY-RHRG	● UTY-RSRG UTY-RHRG+ UTY-TWRXZ2			● UTY-RSRG UTY-RHRG UTY-RSNGM		
Home central remote controller																							● UTY-DMMGM1*3 (KBTA5) ● UTY-DMMGM*3 (LBA6)	
Wireless remote controller								● UTY-LNTG													● UTY-LNTG			
IR receiver unit with Wireless remote controller															● UTY-LRHGM									
								● UTY-LBTGC	● UTY-LBTGM			● UTY-LBTGM			● UTY-LBTGM		● UTY-LBTGH					● UTY-LBTGM		

*1: Available only when the WLAN adapter (UY-TFSXF2) is removed. *2 Available only when the WLAN adapter (UY-TFSXZ1) is removed. *3 Consult your dealer for conditions of use.

Controller system list (available) for Split/Multi-split

Controller Options/Accessories:



Type	Refrigerant	Indoor unit														Indoor unit				Multi-split			
		Wall-mounted						Cassette		Duct		Duct				Floor	Ceiling	Wall-mounted	Compact cassette	Mini duct	Slim duct		
		Designer Series	Standard Series		ECO Series		Compact 4-way flow Series	Circular flow Series	Slim	Medium static pressure (High Efficiency & Comfort)	Medium static pressure (Compact)	Medium static pressure (Standard)	High static pressure		BIG			ASHG 22KMTE	AUXG 07KVLA	ARXG 07/09/12/14/18 KSLAP	ARXG 07KLLAP		
ASHG 07/09/12/14 KGT, KGTB	ASHG 07/09/12/14 KET, KETB	ASHG 07/09/12/14 KMCF, KMCE	ASHG 18/24KMTE	ASHG 30/36KMTE	ASHG 07/09/12 KPCE	ASHG 18/24KLCA	AUXG 09/12/14/18/22/24 KVLA	AUXG 18/22/24/30/36/45/54 KRLB	ARXG 09/12/14/18 KLLAP	ARXH 22/24/30/36/45/54 KMTP	ARXG 12/14/18/22/24/30/36/45/54 KHTAP	ARXG22KMLB, ARXG 24/30/36/45 KMLA	ARXG 45/54KH1B	ARHG 60LHTA	ARHG 72/90LHTA	AGHG 09/12/14 KVCA	ABHG 18/22/24/30/36/45/54 KR1A						
Interfaces	MODBUS® Converter	● UTY-VMSX						● UTY-VMSX		● UTY-VMSX		● UTY-VMSX		● UTY-VMSX	● UTY-VMSX*2	● UTY-VMSX	● UTY-VMSX*1	● UTY-VMSX					
	MODBUS® interface	● FG-AC-MBS1Z1						● FG-RC-MBS1Z1 ● FG-AC-MBS1Z1		● FG-RC-MBS1Z1 ● FG-AC-MBS1Z1		● FG-AC-MBS1Z1	● FG-RC-MBS1Z1	● FG-AC-MBS1Z1	● FG-AC-MBS1Z1		● FG-RC-MBS1Z1 ● FG-AC-MBS1Z1						
WLAN adapter	IR type	● FG-IR-BMG1Z1						● FG-IR-BMG1Z1+ UTY-LBTGC	● FG-IR-BMG1Z1+ UTY-LBTGM	● FG-IR-BMG1Z1+ UTY-LBTGM		● FG-IR-BMG1Z1+ UTY-LRHGM		● FG-IR-BMG1Z1	● FG-IR-BMG1Z1+ UTY-LBTGH	● FG-IR-BMG1Z1		● FG-IR-BMG1Z1+ UTY-LBTGM					
	3-wire RC-line type CN connector type	● FG-AC-KNX1Z1						● FG-RC-KNX1Z1 ● FG-AC-KNX1Z1		● FG-RC-KNX1Z1 ● FG-AC-KNX1Z1		● FG-AC-KNX1Z1	● FG-RC-KNX1Z1	● FG-AC-KNX1Z1	● FG-AC-KNX1Z1		● FG-RC-KNX1Z1 ● FG-AC-KNX1Z1						
External switch controller	IR type	● UTY-VKSX						● UTY-VKSX		● UTY-VKSX		● UTY-VKSX		● UTY-VKSX	● UTY-VKSX*2	● UTY-VKSX	● UTY-VKSX*1	● UTY-VKSX					
	3-wire RC-line type CN connector type	● FG-AC-KNX1Z1						● FG-RC-KNX1Z1 ● FG-AC-KNX1Z1		● FG-RC-KNX1Z1 ● FG-AC-KNX1Z1		● FG-AC-KNX1Z1	● FG-RC-KNX1Z1	● FG-AC-KNX1Z1	● FG-AC-KNX1Z1		● FG-RC-KNX1Z1 ● FG-AC-KNX1Z1						
Network converter for single-split type	3-wire RC-line type ¹ CN connector type	● UTY-TFSXJ3 UTY-TFSXZ1						● UTY-TFSXJ3 UTY-TFSXZ1		● UTY-TFSXJ3 UTY-TFSXZ1		● UTY-TFNXZ1	● UTY-TFSXJ3 UTY-TFSXZ1		● UTY-TFSXJ3 UTY-TFSXZ1								
	USB type ¹	● Accessory (KGT, KET, KET-B, KMCF) UTY-TFSXH3, UTY-TFSXF2 (KGT, KET, KET-B, KMCF)		● UTY-TFSXH3 UTY-TFSXF2												● UTY-TFSXH3 UTY-TFSXF2							
Network converter for single-split type	3-wire RC-line type CN connector type	● FG-AC-WIF1Z1						● FG-RC-WIF1Z2 ● FG-AC-WIF1Z1		● FG-RC-WIF1Z2 ● FG-AC-WIF1Z1		● FG-AC-WIF1Z1	● FG-RC-WIF1Z2	● FG-AC-WIF1Z1	● FG-AC-WIF1Z1		● FG-RC-WIF1Z2 ● FG-AC-WIF1Z1						
	IR type	● FG-IR-WIF1Z1						● FG-IR-WIF1Z1+ UTY-LBTGC	● FG-IR-WIF1Z1+ UTY-LBTGM	● FG-IR-WIF1Z1+ UTY-LBTGM		● FG-IR-WIF1Z1+ UTY-LRHGM		● FG-IR-WIF1Z1	● FG-IR-WIF1Z1+ UTY-LBTGH	● FG-IR-WIF1Z1		● FG-IR-WIF1Z1+ UTY-LBTGM					
Network converter for single-split type	3-wire RC-line type CN connector type	● FG-AC-WMP1Z1						● FG-RC-WMP1Z1 ● FG-AC-WMP1Z1		● FG-RC-WMP1Z1 ● FG-AC-WMP1Z1		● FG-AC-WMP1Z1	● FG-RC-WMP1Z1	● FG-AC-WMP1Z1	● FG-AC-WMP1Z1		● FG-RC-WMP1Z1 ● FG-AC-WMP1Z1						
	IR type	● FG-IR-WMP1Z1						● FG-IR-WMP1Z1+ UTY-LBTGC	● FG-IR-WMP1Z1+ UTY-LBTGM	● FG-IR-WMP1Z1+ UTY-LBTGM		● FG-IR-WMP1Z1+ UTY-LRHGM		● FG-IR-WMP1Z1	● FG-IR-WMP1Z1+ UTY-LBTGH	● FG-IR-WMP1Z1		● FG-IR-WMP1Z1+ UTY-LBTGM					
Network converter for single-split type	DC power supply type	● UTY-TERX+UTY-TWRXZ2						● UTY-TERX		● UTY-TERX		● UTY-TERX		● UTY-TERX	● UTY-TERX*2	● UTY-TERX	● UTY-TERX*2	● UTY-TERX					
	AC power supply type	● UTY-VTGX+UTY-TWRXZ2 or UTY-VTGXV+UTY-TWRXZ2						● UTY-VTGX UTY-VTGXV		● UTY-VTGX UTY-VTGXV		● UTY-VTGX UTY-VTGXV		● UTY-VTGX	● UTY-VTGX+ UTY-TWRXZ3 or UTY-TWRXZ2	● UTY-VTGX UTY-VTGXV	● UTY-VTGX+ UTY-TWRXZ2 or UTY-TWRXZ3	● UTY-VTGX UTY-VTGXV					

*1: Available only when the WLAN adapter (UY-TFSXF2) is removed. *2: Available only when the WLAN adapter (UTY-TFSXZ1) is removed.
*3: For compatibility of the new WLAN adapters with the indoor units which are not listed in this catalogue, please refer to page C-019.

Controller System List (available) for VRF

Controller Options:



Type	Refrigerant	Indoor unit												Indoor unit						
		Cassette			Duct			Duct			Floor		Ceiling/ Floor	Ceiling	Wall-mounted					
		One-way flow	3D flow	Compact Grid type/ Standard type	Circular flow		Mini (With drain pump)	Low static pressure duct		High Efficiency	Medium static pressure				-	External EEV	-	External EEV	-	External EEV
					ARXK 004/007/009/ 012/014/018/ 024GLEH	ARXD 007/009/012/ 014/018/024 GLEH		ARXD 04GALH	ARXD 007/009/012/ 014/018/024 GLEH		ARXP 018/030 GLFH	ARXA 024/030/ 036/045 GLEH	ARXC 036/045/060/ 072/090/096 GTEH	AGHA 004/007/ 009/012/014 GCGH						
Controllers		Indoor unit																		
			● UTY-RNRGZ5												● UTY-RNRGZ5					
			● UTY-RLRG												● UTY-RLRG					
			● UTY-RCRGZ1												● UTY-RCRGZ1					
			● UTY-RSRG ● UTY-RHRG												● UTY-RSRG ● UTY-RHRG					
			● UTY-LNHG												● UTY-LNHG					
IR receiver unit		● UTY-TRHX		● UTY-LBHXD	● UTY-TRHX	● UTB-YWC	● UTY-TRHX			● UTY-TRHX										
Central remote controller		● UTY-DCGGZ2												● UTY-DCGGZ2						
Touch panel controller		● UTY-DTGGZ1												● UTY-DTGGZ1						
System controller, System controller Lite		● UTY-APGXZ1, UTY-ALGXZ1												● UTY-APGXZ1, UTY-ALGXZ1						

Controller System List (available) for VRF

Controller Options:



Type	Refrigerant	Indoor unit										Indoor unit										
		Cassette		Duct				Duct				Floor		Ceiling/ Floor	Ceiling	Wall-mounted						
		One-way flow	3D flow	Compact Grid type/ Standard type	Slim type		Large type		Low static pressure duct		Medium static pressure		High static pressure			-	external EEV	-	external EEV	-	external EEV	-
		AUXV 004/007/009/ 012/014/018/ 024GLEH	AUXS 018/024 GLEH	AUXB 004/007/009/ 012/014/018/ 024GLEH	AUXM 018/024/030 GLEH	AUXK 018/024/030/ 034/036/045/ 054GLEH	ARXK 004/007/009/ 012/014/018/ 024GLGH	ARXD 04GALH	ARXD 007/009/012/ 014/018/024 GLEH	ARXP 018/030 GLFH	ARXA 024/030/ 036/045 GLEH	ARXC 036/045/060/ 072/090/096 GTEH	AGHA 004/007/ 009/012/014 GCGH	AGHE 004/007/ 009/012/014 GCEH	ABHA 012/014/ 018/024 GTEH	ABHA 030/036/ 045/054 GTEH	ASHA 004/007/009 GCGH	ASHE 004/007/009 GCEH	ASHA 012/014GCGH	ASHE 012/014GCEH	ASHA 18/24GBCH	ASHA 030/034GTEH
Interfaces		UTY-ABGXZ1, UTY-VBGX																				
		FG-AC-BAC1Z1										FG-AC-BAC1Z1										
BACnet gateway		FG-AC-BAC1Z1										FG-AC-BAC1Z1										
		FG-IR-BMG1Z1+ UTY-TRHX	FG-IR-BMG1Z1	FG-IR-BMG1Z1+ UTY-LBHXD	FG-IR-BMG1Z1+ UTY-TRHX	FG-IR-BMG1Z1+ UTB-YWC	FG-IR-BMG1Z1+ UTY-TRHX	FG-IR-BMG1Z1+ UTY-TRHX	FG-IR-BMG1Z1+ UTY-TRHX	FG-IR-BMG1Z1+ UTY-TRHX	FG-IR-BMG1Z1+ UTY-TRHX	FG-IR-BMG1Z1+ UTY-TRHX	FG-IR-BMG1Z1+ UTY-TRHX	FG-IR-BMG1Z1+ UTY-TRHX	FG-IR-BMG1Z1+ UTY-TRHX	FG-IR-BMG1Z1	FG-IR-BMG1Z1	FG-IR-BMG1Z1	FG-IR-BMG1Z1	FG-IR-BMG1Z1	FG-IR-BMG1Z1	FG-IR-BMG1Z1
Network converter for LonWorks™		UTY-VLGX																				
MODBUS® Converter		UTY-VMSX																				
		UTY-VMGX FG-TL-MBS16Z1																				
MODBUS® interface		FG-AC-MBS1Z1										FG-RC-MBS1Z1	FG-AC-MBS1Z1	FG-AC-MBS1Z1	FG-AC-MBS1Z1	FG-AC-MBS1Z1	FG-RC-MBS1Z1	FG-RC-MBS1Z1	FG-RC-MBS1Z1	FG-RC-MBS1Z1	FG-RC-MBS1Z1	FG-RC-MBS1Z1
		FG-IR-BMG1Z1+ UTY-TRHX	FG-IR-BMG1Z1	FG-IR-BMG1Z1+ UTY-LBHXD	FG-IR-BMG1Z1+ UTY-TRHX	FG-IR-BMG1Z1+ UTB-YWC	FG-IR-BMG1Z1+ UTY-TRHX	FG-IR-BMG1Z1+ UTY-TRHX	FG-IR-BMG1Z1+ UTY-TRHX	FG-IR-BMG1Z1+ UTY-TRHX	FG-IR-BMG1Z1+ UTY-TRHX	FG-IR-BMG1Z1+ UTY-TRHX	FG-IR-BMG1Z1+ UTY-TRHX	FG-IR-BMG1Z1+ UTY-TRHX	FG-IR-BMG1Z1+ UTY-TRHX	FG-IR-BMG1Z1	FG-IR-BMG1Z1	FG-IR-BMG1Z1	FG-IR-BMG1Z1	FG-IR-BMG1Z1	FG-IR-BMG1Z1	FG-IR-BMG1Z1
KNX® converter		UTY-VKSX																				
		UTY-VKGX FG-TL-KNX16Z1																				
KNX® interface		FG-AC-KNX1Z1										FG-RC-KNX1Z1	FG-AC-KNX1Z1	FG-AC-KNX1Z1	FG-AC-KNX1Z1	FG-AC-KNX1Z1	FG-RC-KNX1Z1	FG-RC-KNX1Z1	FG-RC-KNX1Z1	FG-RC-KNX1Z1	FG-RC-KNX1Z1	
		FG-IR-KNX1Z1+ UTY-TRHX	FG-IR-KNX1Z1	FG-IR-KNX1Z1+ UTY-LBHXD	FG-IR-KNX1Z1+ UTY-TRHX	FG-IR-KNX1Z1+ UTB-YWC	FG-IR-KNX1Z1+ UTY-TRHX	FG-IR-KNX1Z1+ UTY-TRHX	FG-IR-KNX1Z1+ UTY-TRHX	FG-IR-KNX1Z1+ UTY-TRHX	FG-IR-KNX1Z1+ UTY-TRHX	FG-IR-KNX1Z1+ UTY-TRHX	FG-IR-KNX1Z1+ UTY-TRHX	FG-IR-KNX1Z1+ UTY-TRHX	FG-IR-KNX1Z1+ UTY-TRHX	FG-IR-KNX1Z1	FG-IR-KNX1Z1	FG-IR-KNX1Z1	FG-IR-KNX1Z1	FG-IR-KNX1Z1	FG-IR-KNX1Z1	FG-IR-KNX1Z1
WLAN adapter		UTY-TFSXJ3 UTY-TFSXZ1										UTY-TFSXJ3 UTY-TFSXZ1 (007-024)	UTY-TFSXJ3 UTY-TFSXZ1	UTY-TFSXJ3 UTY-TFSXZ1	UTY-TFSXJ3 UTY-TFSXZ1	UTY-TFSXJ3 UTY-TFSXZ1	UTY-TFSXJ3 UTY-TFSXZ1	UTY-TFSXJ3 UTY-TFSXZ1	UTY-TFSXJ3 UTY-TFSXZ1	UTY-TFSXJ3 UTY-TFSXZ1	UTY-TFSXJ3 UTY-TFSXZ1	UTY-TFSXJ3 UTY-TFSXZ1
		FG-AC-WIF1Z1										FG-RC-WIF1Z2	FG-AC-WIF1Z1	FG-AC-WIF1Z1	FG-AC-WIF1Z1	FG-AC-WIF1Z1	FG-RC-WIF1Z2	FG-RC-WIF1Z2	FG-RC-WIF1Z2	FG-RC-WIF1Z2	FG-RC-WIF1Z2	
		FG-IR-WIF1Z1+ UTY-TRHX	FG-IR-WIF1Z1	FG-IR-WIF1Z1+ UTY-LBHXD	FG-IR-WIF1Z1+ UTY-TRHX	FG-IR-WIF1Z1+ UTB-YWC	FG-IR-WIF1Z1+ UTY-TRHX	FG-IR-WIF1Z1+ UTY-TRHX	FG-IR-WIF1Z1+ UTY-TRHX	FG-IR-WIF1Z1+ UTY-TRHX	FG-IR-WIF1Z1+ UTY-TRHX	FG-IR-WIF1Z1+ UTY-TRHX	FG-IR-WIF1Z1+ UTY-TRHX	FG-IR-WIF1Z1+ UTY-TRHX	FG-IR-WIF1Z1	FG-IR-WIF1Z1	FG-IR-WIF1Z1	FG-IR-WIF1Z1	FG-IR-WIF1Z1	FG-IR-WIF1Z1	FG-IR-WIF1Z1	FG-IR-WIF1Z1
		FG-AC-WMP1Z1										FG-RC-WMP1Z1	FG-AC-WMP1Z1	FG-AC-WMP1Z1	FG-AC-WMP1Z1	FG-AC-WMP1Z1	FG-RC-WMP1Z1	FG-RC-WMP1Z1	FG-RC-WMP1Z1	FG-RC-WMP1Z1	FG-RC-WMP1Z1	
		FG-IR-WMP1Z1+ UTY-TRHX	FG-IR-WMP1Z1	FG-IR-WMP1Z1+ UTY-LBHXD	FG-IR-WMP1Z1+ UTY-TRHX	FG-IR-WMP1Z1+ UTB-YWC	FG-IR-WMP1Z1+ UTY-TRHX	FG-IR-WMP1Z1+ UTY-TRHX	FG-IR-WMP1Z1+ UTY-TRHX	FG-IR-WMP1Z1+ UTY-TRHX	FG-IR-WMP1Z1+ UTY-TRHX	FG-IR-WMP1Z1+ UTY-TRHX	FG-IR-WMP1Z1+ UTY-TRHX	FG-IR-WMP1Z1+ UTY-TRHX	FG-IR-WMP1Z1	FG-IR-WMP1Z1	FG-IR-WMP1Z1	FG-IR-WMP1Z1	FG-IR-WMP1Z1	FG-IR-WMP1Z1	FG-IR-WMP1Z1	FG-IR-WMP1Z1
External switch controller		UTY-TERX																				

*1: For compatibility of the new WLAN adapters with the indoor units which are not listed in this catalogue, please refer to page C-019.

Optional parts overview

For Split & Multi-split, VRF

A variety of optional parts are available to enable installation of the selected indoor unit properly according to the environment.

Optional Parts For Cassette



Occupancy sensor kit
A built-in thermo sensor monitors and controls room temperature accurately.



Cassette grille
A lineup of cassette grilles that match a variety of interiors. A grid ceiling-type cassette grille has been added to the lineup.

For Compact cassette For Cassette type
For Cassette type Circular flow



Silver ion filter
The Silver ion filter helps to keep indoor air free from viruses, bacteria and molds.*



Fresh air intake kit
Fresh air can be taken in by a fan connected to an external control unit.

For Compact cassette For Circular flow cassette



Insulation kit for high humidity
Insulation kit for high humidity is used when the installation location is in a high humidity environment.



Air outlet shutter plate
Airflow directions can be changed to 3 directions using the Air outlet shutter plate depending on the installation location.

For Compact cassette For Circular flow cassette



Wide Panel
When a cassette type is installed in a narrow space in the ceiling, the wide panel fills in that space.

Indoor unit 950
Panel 600 (mm)
600



Panel spacer
If the ceiling space is tight and the main body protrudes from the ceiling surface, a panel spacer can be used as a decorative trim.

242 mm
Panel spacer

Optional Parts For V-IV



Pressure sensor kit
The height difference of the pressure sensor kit can be extended up to 110 m.

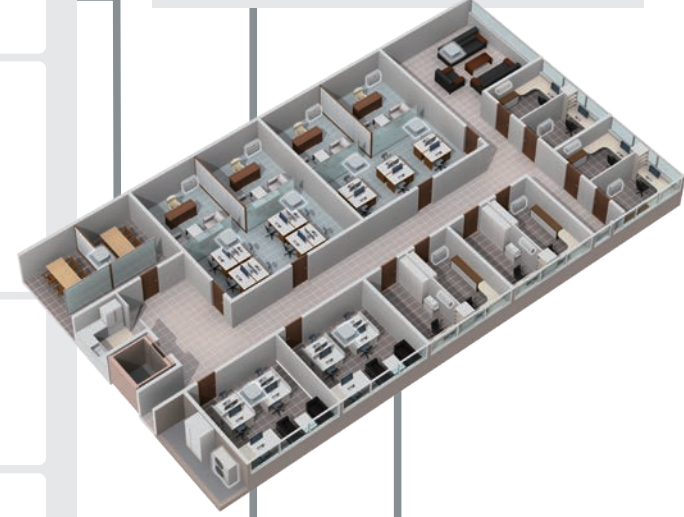



Optional Parts For Floor

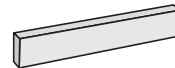

Half concealed kit
Used to half conceal a floor type indoor unit in the wall.



Silver ion filter
The Silver ion filter helps to keep indoor air free from viruses, bacteria and molds.*



Optional Parts For Duct & Ceiling



Auto louver grille kit
The optional clean-looking flat Auto louver grille blends into any interior and provides a comfortable airflow.



Remote sensor unit
The remote sensor provides additional convenience.

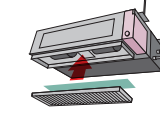

Silver ion filter
The Silver ion filter helps to keep indoor air free from viruses, bacteria and molds.*



Long-life filter
Captures grit and dust. Long-life design with consideration of running costs.



Flange
Flanges are used when connecting a medium static pressure duct type and a ceiling type with air intake and exhaust ducts.



Drain pump unit
Drains water that has accumulated during operation.

Connection Parts



Communication kit
Required for a wall-mounted type when the External connect kit set or a Wired remote controller is connected to the indoor unit.

For wall-mounted type

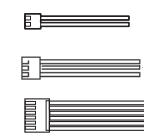

External connect kit & set
Connect the printed circuit board (PCB) to external devices.



Connection Units
Connection units are available to separate the pipes when connecting multiple indoor units in a Multi-split type or VRF system.



External power supply unit
The External power supply unit protects the increment in the system even if the power supply for some of the indoor units is shut down.



External input and output PCB
For Wall-mounted, Duct, or Cassette type, these parts are required when the external input and output function is used.

For wall-mounted type



External input and output PCB box & bracket
Box and bracket for installing the External input and output PCB.

For Duct type and Cassette type

*Not a result of experiments in an actual use environment. Silver ion filter inhibits activity or growth of microorganism, but do not prevent infection.

Silver Ion Filter

UTR-FA16-5 / UTR-FA13-3 / UTR-FA03-5 / UTD-HFAA / UTD-HFRA / UTD-HFTA / UTD-HFTB / UTD-HFTC / UTD-HFNC / UTD-HFNB / UTD-HFNA / UTD-HFND / UTD-HFKB / UTD-HFKA



For Wall mounted / Floor
UTR-FA16-5 / UTR-FA13-3
UTR-FA03-5

For Cassette
UTD-HFAA / UTD-HFRA

For Duct
UTD-HFTA / UTD-HFTB
UTD-HFTC / UTD-HFNC
UTD-HFNB / UTD-HFNA
UTD-HFND / UTD-HFKB
UTD-HFKA

The Silver ion filter helps to keep indoor air free from viruses, bacteria and molds.

(Not a result of experiments in an actual use environment. Silver ion filter inhibits activity or growth of microorganism, but do not prevent infection.)

The silver ion filter inhibits the activities of viruses*1, bacteria*2 and molds*3 trapped on the filter.

(Only effective when the microorganism is trapped on the filter with dust or droplet)

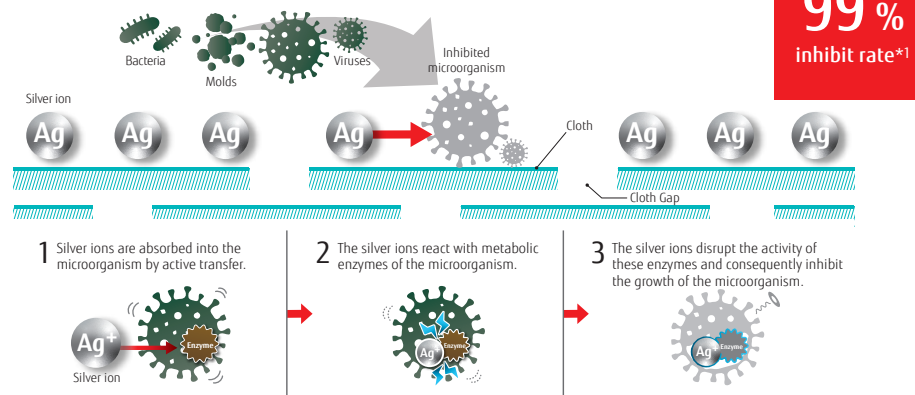

*1 [Testing organization] Kitasato Research Center for Environmental Science [Test Report] No. 2020_0408 [Test virus] Escherichia coli phage Qbeta NBRC 20012 (1 type) [Test Method] Based on the antiviral test method for textile products (JIS L 1922) [Test results] Inhibited by at least 99% in 24 hours. Not tested to prevent transmission of SARS-CoV-2.
*2 [Testing organization] Kitasato Research Center for Environmental Science [Test Report] No. 2020_0409 [Test bacteria] Escherichia coli NBRC 3972 (1 type) [Test Method] Based on the determination of antibacterial activity and efficacy of textile products (JIS L 1902) [Test results] The growth of the test bacteria was inhibited by 24 hours testing
*3 [Testing organization] Kitasato Research Center for Environmental Science [Test Report] No. 2020_0410 [Test fungi] Aspergillus Niger NBRC 105649 and other fungi (3 types) [Test Method] Based on the test for fungus resistance (JIS Z 2911) [Test results] The growth of the fungus was inhibited by 28 days testing

The filter is easily removable* and hand-washable.

(*Wall mounted and floor models only)



*4 Hand-washing or vacuuming by 3 months is recommended. Cleaning frequency varies depending on the environment of use.

Specifications

Model name	For Wall mounted / Floor			for Cassette		
	UTR-FA16-5	UTR-FA13-3	UTR-FA03-5	UTD-HFAA	UTD-HFRA	
Net Dimension (H x W x D)	mm	35 x 210 x 6	50 x 364 x 6	43 x 272 x 6	350 x 125 x 6	550 x 136 x 6
Weight	g	2	2	2	7	23
Quantity		2	2	2	1	1

Model name	for Duct									
	UTD-HFTA	UTD-HFTB	UTD-HFTC	UTD-HFNC	UTD-HFNB	UTD-HFNA	UTD-HFND	UTD-HFKB	UTD-HFKA	
Net Dimension (H x W x D)	mm	290 x 70 x 6	390 x 70 x 6	290 x 70 x 6 390 x 70 x 6	620 x 88 x 6	420 x 88 x 6	620 x 88 x 6	500 x 79 x 6	420 x 125 x 6	620 x 108 x 6
Weight	g	6	8	10	8	10	16	12	16	20
Quantity		2	2	3	1	2	2	2	2	2

Auto louver grille kit

UTD-GXTA-W / UTD-GXTB-W / UTD-GXTC-W



The optional clean-looking flat Auto louver grille kit blends into any interior and provides a comfortable airflow.



Flexible Control

- The Auto louver grille of the indoor unit can be operated in conjunction with the remote control of the indoor unit.
- Vertical auto swing**
 - Auto airflow direction and auto swing
 - 4 steps selectable
- Auto-closing louver**
 - The louvers will automatically close when the indoor unit stops operating.

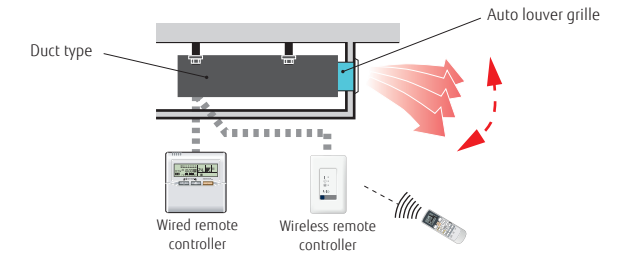

Dimensions

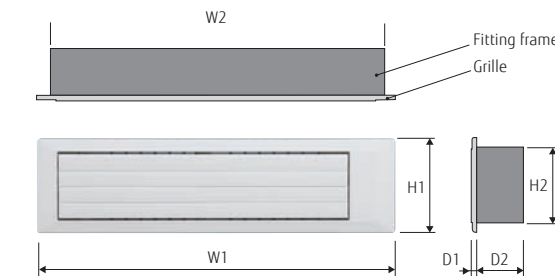

Model name	W1	W2	H1	H2	D1	D2
UTD-GXTA-W	683	645	180	148	9	84
UTD-GXTB-W	883	845	180	148	9	84
UTD-GXTC-W	1,083	1,045	180	148	9	84

Unit: mm

Specifications

Model name	UTD-GXTA-W	UTD-GXTB-W	UTD-GXTC-W		
Applicable indoor unit	ARHG07/09LLTA ARHG12/14LLTB ARXG09/12/14KLLAP ARHG07/09/12/14LSLAP ARXD007/009/012/014GLEH (for VRF) ARXK004/007/009/012/014GLEH (for VRF) ARXD04GALH (for VRF)	ARHG18LLTB ARXG18KLLAP ARHG18LSLAP ARXD018GLEH (for VRF) ARXK018GLEH (for VRF)	ARXD024GLEH (for VRF) ARXK024GLEH (for VRF)		
Power supply	Connecting with Control box of indoor unit				
Fixing Auto louver grille	Screwed to Flange or Square duct				
Extension Square duct limit	1.0 m (Max. duct length between indoor unit and Auto louver grille)				
Net Dimensions (H x W x D)	mm	180 x 683 x (84 + 9)	180 x 883 x (84 + 9)	180 x 1,083 x (84 + 9)	
Weight	Net	kg	2.0 (4.4)	2.5 (5.6)	3.0 (6.7)
	Gross	(lbs)	3.0 (6.7)	3.5 (7.8)	4.0 (8.9)
Color	White				
Louver motor	Stepping motor				
Accessories	Fitting Flame, etc.				
Operating range	Cooling	°C	18 to 32		
		% RH	80 % or less		
Operating range	Heating	°C	16 to 30		

Pressure sensor kit

UTY-SPWX



Design flexibility

The height difference between the outdoor unit and the indoor unit is normally 50 m for the V-IV Series, but can be extended to 110 m by installing the Pressure sensor kit. (Can only be connected to the V-IV Series. Also, it can only be connected to outdoor units using outdoor unit software compatible with the product.)

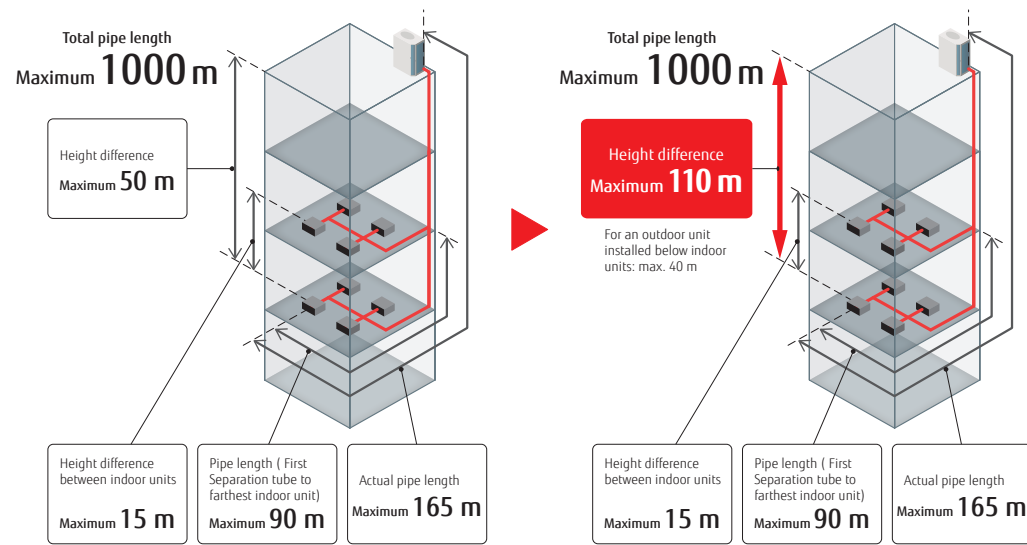

System overview

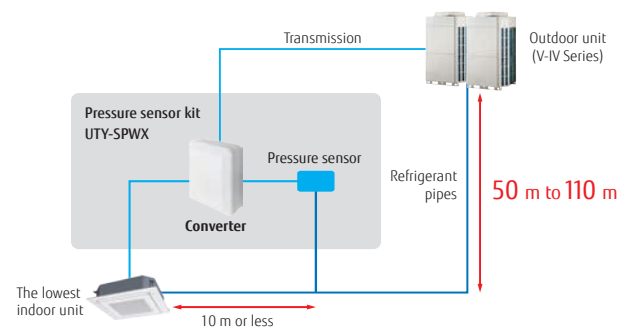

Pressure sensor kit

Pressure sensor kit (Converter)	Refrigerant pressure sensor	Joint pipe

Specifications

Model name	UTY-SPWX
Power supply	9 to 16 V DC
Dimensions (H × W × D) (mm)	140 × 117 × 43
Weight (g)	200

External power supply unit

UTZ-GXXA / UTZ-GXXC



The External power supply unit protects the increment in the system even if the power supply for some of the indoor units is shut down.

Connects to the External power supply unit to supply power to the indoor unit from the auxiliary power supply. This allows for continuous operation without system errors. Built-in relays reduce installation time and cost. The UTZ-GXXC has a built-in relay, which reduces installation time and cost.

High reliability

- A: Interruption of the main power supply is detected by the power cut-off detection part.
- B: Supplies power for driving the expansion valve of the indoor unit. (12 V or 5 V DC)
- C: Gives notification of the power supply from the External power supply unit.

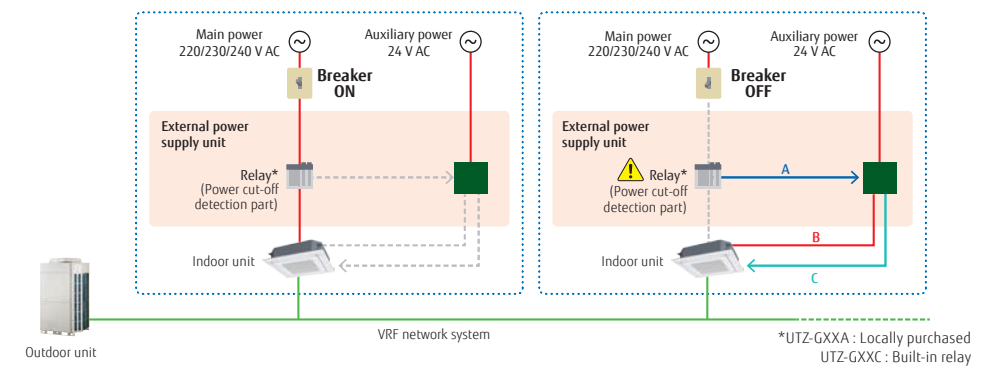

Note

- When changing the power supply voltage to 24 V AC, use a power transformer with an insulated structure that complies with the regulations* of the installation region.
- A powered-off indoor unit driven by the External power supply unit is treated in the same way as an operation-off unit in the electricity charge appointment function. If standby power is generated, the result of the electricity charge appointment may not be zero.

*UL Class II or IEC 61558 Class III, for example.

Specifications

Model name	UTZ-GXXA	UTZ-GXXC
Power supply	24 V AC 50/60 Hz	
Dimensions (H × W × D) (mm)	97 × 200 × 178	
Weight (g)	800	

AIR BEAM Radiation air outlet unit

*Production by order
Contact us for more details.



Key component

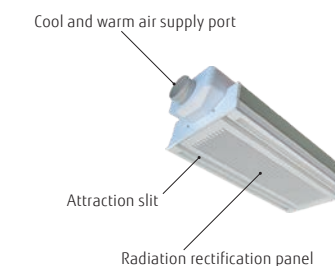

Cross-section view

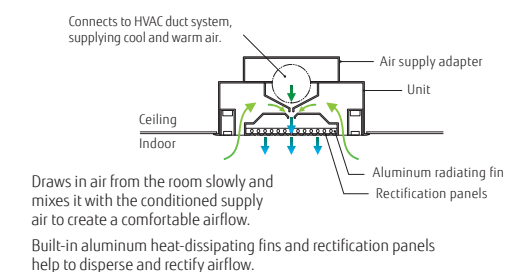

Airflow rate (m ³ /h)	180 (160-215)	270 (240-325)
Grid	600 × 2	600 × 3
AIR BEAM For system ceiling (Integrated type)	KS-180	KS-270

Optional parts list for Split/Multi-split



Type	Refrigerant	Indoor unit																					
		Wall-mounted						Cassette		Duct					Indoor unit			Multi-split					
		Designer Series		Standard Series		ECO Series		4-way flow Compact	Circular flow	Slim	Medium static pressure (High-Efficiency & Comfort)	Medium static pressure (Compact)	Medium static pressure (Standard)	High static pressure	Big	Floor	Ceiling	4-way flow Compact cassette	Mini duct	Slim duct			
		ASHG 07/09/12/14 KGTF, KGTE	ASHG 07/09/12/14 KETF, KETF-B KETE, KETE-B	ASHG 07/09/12/14 KMCF, KMCE ASHG18/24KMT E	ASHH30/36KMTB	ASHG 07/09/12 KPCE	ASHG18/24KLCA	AUXG 09/12/14/18/22/24 KVLA	AUXG 18/22/24/30/36/45/54 KRLB	ARXG 09/12/14/18 KLLAP	ARXH 22/24/30/36/45/54 KMTAP	ARXG 12/14/18/22/24/30/36/45/54 KHTAP	ARXG22KMLB, ARXG 24/30/36/45 KMLA	ARXG45/54KHTB	ARHG60LHTA	ARHG72/90LHTA	AGHG 09/12/14 KVCA	ABHG 18/22/24/30/36/45/54 KRTA	AUXG07KVLA	ARXG 07/09/12/14/18 KSLAP	ARXG07KLLAP		
Occupancy sensor kit									● UTY-SHZXC														
Remote sensor unit	 The remote sensor provides additional convenience.															● UTY-XSZX21						● UTY-XSZX21	
Cassette grille								● UTG-UGFG-W	● UTG-UKGA-W, UTG-UKGC-W, UTG-UKGA-B											● UTG-UGFG-W (KVLA), UTG-UGFG-W (LVLA)			
Auto louver grille kit										● UTD-GXTA-W (09/12/14) UTD-GXTB-W (18)												● UTD-GXTA-W (07/09/12/14), UTD-GXTB-W (18)	
Silver ion filter			● UTR-FA16-5		● UTR-FA13-3		● UTR-FA16-5	● UTD-HFAA	● UTD-HFRA	● UTD-HFTA (09/12/14) UTD-HFTB (18)	● UTD-HFNB (22/24), UTD-HFNA (30/36/45/54)	● UTD-HFNC (12/14) UTD-HFNB (18/22/24/30) UTD-HFNA (36/45/54)	● UTD-HFND	● UTD-HFKB (45/54)	● UTD-HFKA	● UTR-FA03-5		● UTD-HFAA	● UTD-HFTA (07/09/12/14) UTD-HFTB (18)	● UTD-HFTA			
Long-life filter											● UTD-LFDB (22/24), UTD-LFDA(30/36/45/54)	● UTD-LFNA (36/45/54) UTD-LFNB (18/22/24/30) UTD-LFNC (12/14)	● UTD-LF2SNA	● UTD-LF60KA (45/54)	● UTD-LFKA								
Flange														● UTD-SF045T UTD-RF204									
Drain pump unit														● UTZ-PX1NBA		● UTZ-PX1NAB			● UTR-DPB24T				
Wide Panel										● UTG-AKXA-W													
Panel spacer										● UTG-BKXA-W													
Fresh air intake kit								● UTZ-VXAA	● UTZ-VXRA											● UTZ-VXAA			
Air outlet shutter plate								● UTR-YDZB	● UTR-YDZK											● UTR-YDZB			
Insulation kit for high humidity								● UTZ-KXGC	● UTZ-KXRA											● UTZ-KXGC			
Half concealed kit	 Used to half conceal a floor type indoor unit in the wall.																● UTR-STA						
L-type piping kit																				● UTP-FX24A (18/22/24) UTP-FX35A (30/36/45/54)			

Optional parts list for VRF



Type	Refrigerant	Indoor unit														Indoor unit				Outdoor unit				
		Cassette			Slim type		Large type		Duct				Duct		Floor		Floor/Ceiling	Ceiling	Wall-mounted				V-IV Series	
		One-way flow	3D flow	Compact grid type/ Standard type	Circular flow		Mini (With drain pump)	Slim (With drain pump)		High Efficiency	Medium static pressure	High static pressure		-	external EEV	-	external EEV	-	-	-	external EEV	-	-	-
		AUXV 004/007/009/ 012/014/018/ 024GLEH	AUXS 018/024GLEH	AUXB 004/007/009/ 012/014/018/ 024GLEH	AUXM 018/024/030 GLEH	AUXK 018/024/030/ 034/036/045/ 054GLEH	ARXK 004/007/009/ 012/014/018/ 024GLGH	ARXD 04GALH	ARXD 007/009/012/ 014/018/024 GLEH	ARXP 018/030 GLFH	ARXA 024/030/ 036/045 GLEH	ARXC 036/045/060 GTEH	ARXC 072/090/096 GTEH	AGHA 004/007/ 009/012/014 GCGH	AGHE 004/007/ 009/012/014 GCEH	ABHA 012/014/ 018/024 GTEH	ABHA 030/036/ 045/054 GTEH	ASHA 004/007/009 012/014 GCGH	ASHE 004/007/009 012/014 GCEH	ASHA 18/24GBCH	ASHA 030/034GTEH	AJH 072/090/108/ 126/144/162 LALDH		
Occupancy sensor kit					•	UTY-SHZXC																		
Remote sensor unit									•	UTY-XS2XZ1			•	UTY-XS2XZ1										
Cassette grille		•	•	•	•																			
Auto louver grille kit									•	UTD-GXTA-W (4-14), UTD-GXTB-W (18), UTD-GXTC-W (24)														
Silver ion filter				•	•	•	•	•	•	•	•	•	•	•	•	•	•	•	•	•	•	•	•	
Long-life filter													•	•	•									
Flange													•	•							•	•		
Drain Pump Unit													•	•							•	•		
Wide Panel																								
Panel spacer																								
Fresh air intake kit*1																								
Air outlet shutter plate:																								
Insulation kit for high humidity																								
Half concealed kit																								
External power supply unit																								
Pressure sensor kit																								

Function list for Split/Multi-split



External input and output function/External connect kit/communication kit

Type	Refrigerant	Indoor unit											Floor	Ceiling	Multi-split					Outdoor unit																			
		Wall-mounted			Cassette		Duct								Wall-mounted	Mini duct	Slim duct	Compact cassette	Single Split			Simultaneous multi-split																	
		Designer Series	Standard Series		ECO Series	Compact 4-way flow Series	Circular flow Series	Slim	Medium static pressure (High-Efficiency & Comfort)	Medium static pressure (Compact)	Medium static pressure (Standard)	High static pressure							Big	AGHG 09/12/14 KVCA	ABHG 18/22/24/30/36/45/54 KRTA	ASHG 22KMT	ARXG 07/09/12/14/18 KSLAP	ARXG 07KLLAP	AUXG 07KVLA	ADHG 30/36/45/54 KRTB, ADHG 30/36/45/54 KRTA	ADHG 36/45/54 LAT1	ADHG 45/54/61/60 LATA, ADHG 72/90/LRLA	ADHG 36/45/54 KRTA	ADHG 36/45/54 LAT1	ADHG 36/45/54 LAT2								
Indoor	R32 R410A	Operation/Stop							• UTY-XCSXZ2+ UTY-XWZKZ5	• PCB Terminal • UTY-XCSX UTZ-GXDA	• PCB Terminal	• PCB Terminal • UTY-XCSX UTZ-GXDA	• PCB Terminal • UTY-XCSX UTZ-GXDA	• PCB Terminal			• PCB Terminal • UTY-XCSX UTZ-GXEA	• UTD-ECSSA	• PCB Terminal • UTY-XCSX	• UTY-XWZKZ5	• PCB Terminal • UTY-XCSX UTZ-GXEA	• UTY-XCSXZ2+ UTY-XWZKZ5	• PCB Terminal	• UTD-ECSSA	• PCB Terminal														
		Forced stop															• PCB Terminal • UTY-XCSX UTZ-GXEA	• UTD-ECSSA	• PCB Terminal	• UTY-XWZKZ5	• PCB Terminal • UTY-XCSX UTZ-GXEA	• UTY-XCSXZ2+ UTY-XWZKZ5	• PCB Terminal	• UTD-ECSSA	• PCB Terminal														
		Forced Thermostat off									• UTY-XCSX UTZ-GXDA		• UTY-XCSX UTZ-GXDA	• UTY-XCSX UTZ-GXDA				• UTY-XCSX UTZ-GXEA	• UTD-ECSSA	• UTY-XCSX	• UTY-XWZKZ5	• UTY-XCSX UTZ-GXEA	• UTY-XCSXZ2+ UTY-XWZKZ5																
		Low noise mode operation																														• UTY-XWZKZ3	• UTY-XWZKZ2			• UTY-XWZKZ3	• UTY-XWZKZ2	○ UTY-XWZKZ2	
		Outdoor unit operation peak control																															• UTY-XWZKZ3	• UTY-XWZKZ2			• UTY-XWZKZ3	• UTY-XWZKZ2	○ UTY-XWZKZ2
Indoor	R32 R410A	Operation status							○ UTY-XCSXZ2+ UTY-XWZKZ5	○ UTY-XCSX UTZ-GXDA	○ UTY-XWZKZG	○ UTY-XCSX UTZ-GXDA	○ UTY-XWZKZG	○ UTY-XCSX UTZ-GXEA	○ UTY-XWZKZG			○ UTY-XCSX UTZ-GXEA	○ UTD-ECSSA	○ UTY-XWZKZG	○ UTY-XWZKZ5	○ UTY-XWZKZG	○ UTY-XCSXZ2+ UTY-XWZKZ5	○ UTY-XWZKZG	○ UTD-ECSSA	○ UTY-XWZKZG													
		Error status							○ UTY-XCSXZ2+ UTY-XWZKZ5	○ UTY-XCSX UTZ-GXDA	○ UTY-XWZKZG	○ UTY-XCSX UTZ-GXDA	○ UTY-XWZKZG	○ UTY-XCSX UTZ-GXEA	○ UTY-XWZKZG			○ UTY-XCSX UTZ-GXEA	○ UTD-ECSSA	○ UTY-XWZKZG	○ UTY-XWZKZ5	○ UTY-XWZKZG	○ UTY-XCSXZ2+ UTY-XWZKZ5	○ UTY-XWZKZG	○ UTD-ECSSA	○ UTY-XWZKZG													
		Compressor status																																					
		Indoor unit fan operation status								○ UTY-XCSXZ2+ UTY-XWZKZ5	○ UTY-XCSX UTZ-GXDA	○ UTY-XWZKZG	○ UTY-XCSX UTZ-GXDA	○ UTY-XWZKZG	○ UTY-XCSX UTZ-GXEA	○ UTY-XWZKZG			○ UTY-XCSX UTZ-GXEA	○ UTD-ECSSA	○ UTY-XWZKZG	○ UTY-XWZKZ5	○ UTY-XWZKZG	○ UTY-XCSXZ2+ UTY-XWZKZ5	○ UTY-XWZKZG	○ UTD-ECSSA	○ UTY-XWZKZG												
		Setpoint attainment status																																					
		Auxiliary heater output								○ UTY-XCSXZ2+ UTY-XWZKZ5	○ UTY-XCSX UTZ-GXDA	○ UTY-XWZKZG	○ UTY-XCSX UTZ-GXDA	○ UTY-XWZKZG	○ UTY-XCSX UTZ-GXEA	○ UTY-XWZKZG			○ UTY-XCSX UTZ-GXEA	○ UTD-ECSSA	○ UTY-XWZKZG	○ UTY-XWZKZ5	○ UTY-XWZKZG	○ UTY-XCSXZ2+ UTY-XWZKZ5	○ UTY-XWZKZG	○ UTD-ECSSA	○ UTY-XWZKZG												

*1: Included in Fresh air intake kit (UTZ-VXAA or UTZ-VXRA) *2: Functionality for installation in a server room

•: Dry Contact ○: Apply Voltage

For SPLIT/MULTI-SPLIT/SIMULTANEOUS MULTI-SPLIT

<p>Communication kit</p> <p>UTY-TWRXZ3 UTY-TWRXZ2</p>	<p>External input and output PCB</p> <p>UTY-XCSXZ1 (wire length 280 mm) UTY-XCSXZ2 (wire length 80 mm) for Wall-mounted type</p> <p>UTY-XCSX for Duct and Cassette types</p>	<p>External input and output PCB box</p> <p>UTZ-GXDA (for Duct) UTZ-GXRA (for Cassette) UTZ-GXEA (for Ceiling)</p>	<p>External input and output PCB bracket</p> <p>UTZ-GXNA</p>
---	---	---	---

Communication system

External connect kit		
For indoor unit	For outdoor unit	
UTY-XWZX	UTY-XWZXZ2	UTY-XWZXZ3
UTY-XWZXZ5		
UTY-XWZXZG		

External control set

For indoor unit

UTD-ECSSA

Function list for VRF



External input and output function/External connect kit

Type	Refrigerant	Indoor unit												Indoor unit				Outdoor unit					controller	Other							
		One-way flow	3D flow	Cassette		Duct		Low static pressure			Medium static pressure	High static pressure	Floor		Wall-mounted		J-IVL	J-IV	J-IVS	V-IV	VR-IV	Central remote controller	RB unit								
				Compact grid type/Standard type	Slim type	Large type	Mini (With drain pump)	Slim (With drain pump)	High Efficiency	Normal	Normal		EEV external	Floor/Ceiling		EEV external			AH	AH	AH	AH	AH								
		AUXV 004/007/009/ 012/014/018/ 024GLEH	AUXS 018/024/ GLEH	AUXB 004/007/009/ 012/014/018/ 024GLEH	AUXM 018/024/030/ GLEH	AUXK 018/024/030/ 034/036/045/ 054GLEH	ARXK 004/007/009/ 012/014/018/ 024GLEH	ARXD 007/009/012/ 014/018/024/ GLEH, ARXD 04GALH	ARXP 018/030/ GLEH	ARXA 024/030/ 036/045/ GLEH	ARXC 036/045/060/ 072/090/096/ GTEH	AGHA 004/007/ 009/012/014/ GCGH	AGHE 004/007/ 009/012/014/ GCEH	ABHA 012/014/018/ 024GTEH	ABHA 030/036/045/ 054GTEH	ASHA 004/007/009/ 012/014/ GCGH	ASHE 004/007/009/ 012/014/ GCEH	ASHA 18/24GBCH	ASHA 030/034GTEH	AH 072/090/108/ 126/144/162/ LELDH	AH 040/045/054/ LBLDH, AH 040/045/054/ LELDH	AH 040/045/054/ LCLDH	AH 072/090/108/ 126/144/162/ LALDH	AH 072/090/108/ 126/144/ GALDH	UTY-DCGGZ2	UTP-RX01AH UTP-RX01BH UTP-RX01CH UTP-RX04BH UTP-RX08AH UTP-RX12AH					
Input	Operation/Stop	● UTY-XWZXZD ○ UTY-XWZXZB											● UTY-XWZXZD ○ UTY-XWZXZB																		
	All On/All Off																										●UTY-XWZXZ7 ○UTY-XWZXZ8				
	Group stop																											● UTY-XWZXZ6			
	Forced stop																														
	Emergency stop																												●UTY-XWZXZ7 ○UTY-XWZXZ8		
	Forced thermostat off																														
	Low noise mode operation																													● UTY-XWZXZ6	
	Cooling/ Heating priority																														●UTY-XWZXZ6 ○UTY-XWZXZ8
	Outdoor unit operation peak control																														● UTY-XWZXZ6
Output	Power usage information from electricity meter																													● UTY-XWZXZF	
	Operation status																													● UTY-XWZXZC	
	Error status																													● UTY-XWZXZC	
	Indoor unit fan operation status																													● UTY-XWZXZC	
	Auxiliary heater output																													● UTY-XWZXZC	
	Base pan heater																													● UTY-XWZXZ9	
																															● UTY-XWZXZ9

*2: The Touch panel controller has the functions of dry contact and voltage application, but the external connection kit described above is not necessary because the touch panel controller has an external input terminal block.

●: Dry Contact ○: Apply Voltage

Communication system

External connect kit

For indoor unit

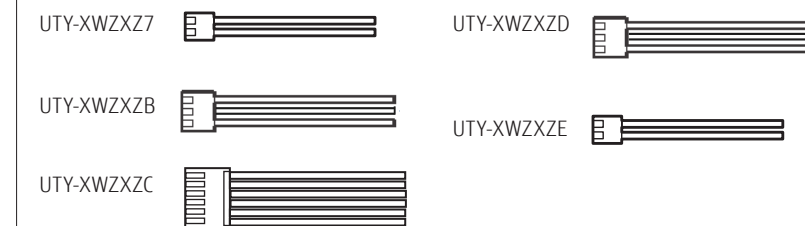

For outdoor unit

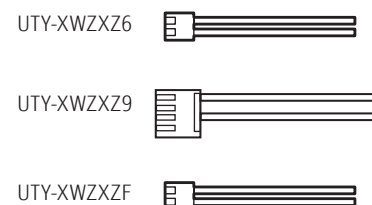

For RB unit

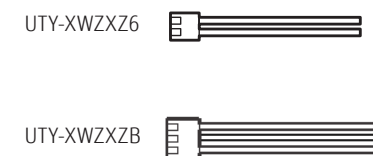

Central remote controller

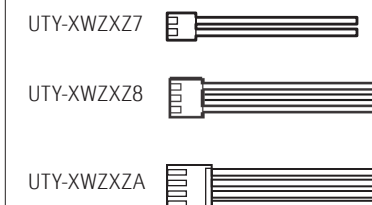



For Touch panel controller





















Separation tube













For SPLIT/MULTI-SPLIT/SIMULTANEOUS MULTI-SPLIT

<p>Separation tube</p> <p>UTP-SX236A / UTP-SX254A For 3-phase simultaneous multi-split</p> <p>UTP-SX272A For Simultaneous multi-split Twin/ Triple/Double Twin</p> 	<p>UTP-SX354A For 3-phase simultaneous multi-split</p> <p>UTP-SX372A For Simultaneous multi-split Twin/ Triple/Double Twin</p> 
--	--







for VRF

<p>Separation tube</p> <p>UTP-AX054A</p> <p>Gas pipe</p>  <p>Liquid pipe</p> 	<p>UTP-AX090A</p> <p>Gas pipe</p>  <p>Liquid pipe</p> 	<p>UTP-AX180A</p> <p>Gas pipe</p>  <p>Liquid pipe</p> 	<p>UTP-AX567A</p> <p>Gas pipe</p>  <p>Liquid pipe</p> 
<p>UTP-BX090A</p> <p>Suction Gas pipe</p>  <p>Discharge Gas pipe</p>  <p>Liquid pipe</p> 	<p>UTP-BX180A</p> <p>Suction Gas pipe</p>  <p>Discharge Gas pipe</p>  <p>Liquid pipe</p> 	<p>UTP-BX567A</p> <p>Suction Gas pipe</p>  <p>Discharge Gas pipe</p>  <p>Liquid pipe</p> 	<p>UTP-LX180A For DX kit</p> 

Header

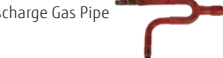
<p>UTR-H0906L / UTR-H1806L</p> <p>Gas pipe</p>  <p>Liquid pipe</p> 	<p>UTR-H0908L / UTR-H1808L</p> <p>Gas pipe</p>  <p>Liquid pipe</p> 	<p>UTP-J0906A / UTP-J1806A</p> <p>Suction gas pipe</p>  <p>Discharge gas pipe</p>  <p>Liquid pipe</p> 	<p>UTP-J0908A / UTP-J1808A</p> <p>Suction gas pipe</p>  <p>Discharge gas pipe</p>  <p>Liquid pipe</p> 
---	---	---	---



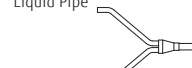

Outdoor unit branch kit

<p>UTP-CX567A</p> <p>Gas Pipe</p>  <p>Liquid Pipe</p> 	<p>UTP-DX567A</p> <p>Suction Gas Pipe</p>  <p>Discharge Gas Pipe</p>  <p>Liquid Pipe</p> 	<p>UTP-EX060A</p> <p>Gas Pipe</p>  <p>Liquid Pipe</p> 	<p>UTP-EX096A</p> <p>Gas Pipe</p>  <p>Liquid Pipe</p> 
--	--	--	--

Separation tube for RB unit

for VRF

<p>EV kit</p> <p>Model name ≤ 09: UTR-EV09XB Model name ≥ 12: UTR-EV14XB for compact wall-mounted type</p> 
--

<p>RB unit</p> <p>UTP-RX01AH / UTP-RX01BH / UTP-RX01CH Single type</p> 	<p>UTP-RX04BH Multi-split type</p> 	<p>UTP-RX08AH Multi-split type</p> 	<p>UTP-RX12AH Multi-split type</p> 
--	--	--	--

Specifications

Separation tube

Model name	UTP-AX054A	UTP-AX090A	UTP-AX180A	UTP-AX567A
Total cooling capacity of indoor unit (kW)	19.6 or less	28.0 or less	28.1 to 56.0	56.1 or more

Model name	UTP-BX090A	UTP-BX180A	UTP-BX567A
Total cooling capacity of indoor unit (kW)	28.0 or less	28.1 to 56.0	56.1 or more

Header

Model name	3-6 Branches	UTR-H0906L	UTR-H1806L
	3-8 Branches	UTR-H0908L	UTR-H1808L
Total cooling capacity of indoor unit (kW)		28.0 or less	28.1 to 56.0

Model name	3-6 Branches	UTP-J0906A	UTP-J1806A
	3-8 Branches	UTP-J0908A	UTP-J1808A
Total cooling capacity of indoor unit (kW)		28.0 or less	28.1 to 56.0

Outdoor unit branch kit

Model name	UTP-CX567A (for V-IV)		UTP-DX567A (for VR-IV)	
Number of outdoor units	2 outdoor units			1
	3 outdoor units			2

EV kit

Model name	UTR-EV09XB		UTR-EV14XB	
Application model	ASHE004GCEH ASHE007GCEH ASHE009GCEH	AGHE004GCEH AGHE007GCEH AGHE009GCEH	ASHE012GCEH ASHE014GCEH	AGHE012GCEH AGHE014GCEH

RB unit

Type		Single type			Multi-split type	
Model name		UTP-RX01AH	UTP-RX01BH	UTP-RX01CH	UTP-RX04BH	UTP-RX08AH / UTP-RX12AH
Power source	V/Ø/Hz	230/1/50				
Input power	W	17	24	31	96	136 / 204
Number of branches		1	1	1	4	8 / 12
Maximum capacity of connectable indoor units (Q)	kW	Q \leq 8.0	Q \leq 18.0	Q \leq 28.0	Q \leq 56.1*1	Q \leq 72.0 / Q \leq 95.0
Maximum capacity of connectable indoor units per branch (Q)	kW	Q \leq 8.0	Q \leq 18.0	Q \leq 28.0	Q \leq 18.0	Q \leq 8.0 / Q \leq 8.0
Maximum Connectable Indoor Units per Branch		3	8	8	8	7 / 7
Dimensions (H x W x D)	mm	198 x 298 x 268			260 x 658 x 428	298 x 660 x 618 / 298 x 990 x 618

*1: When two RB units are connected in series (8 branches in total), the maximum capacity of the connectable indoor units is up to 56.0 kW.

Residential AIR TO WATER

- W-002 WATERSTAGE Overview
- W-004 WATERSTAGE Lineup
- W-006 Benefits
- W-008 Home Heating & Domestic Hot Water Supply
- W-010 High-Efficiency Technology
- W-012 Split Type
 - Comfort Series
 - Super High Power Series
 - High Power Series
- W-018 Split DHW Integrated Type
 - Comfort Series
 - Super High Power Series
 - High Power Series
- W-024 Control Overview
- W-026 Comfort Control
- W-028 System Configuration
- W-030 Case Studies
- W-032 Simple installation
 - Easy Installation & Maintenance
- W-034 Installation Requirements
- W-036 AIR TO WATER Optional Parts



WATERSTAGE™

Innovative solutions for Home Heating

SPLIT TYPE/SPLIT DHW INTEGRATED TYPE

AIR TO WATER
Residential



FUJITSU GENERAL LIMITED

WATERSTAGE Overview

Solutions that meet a variety of needs

Water heated by WATERSTAGE using clean energy is delivered reliably and comfortably throughout the house, including the living room.

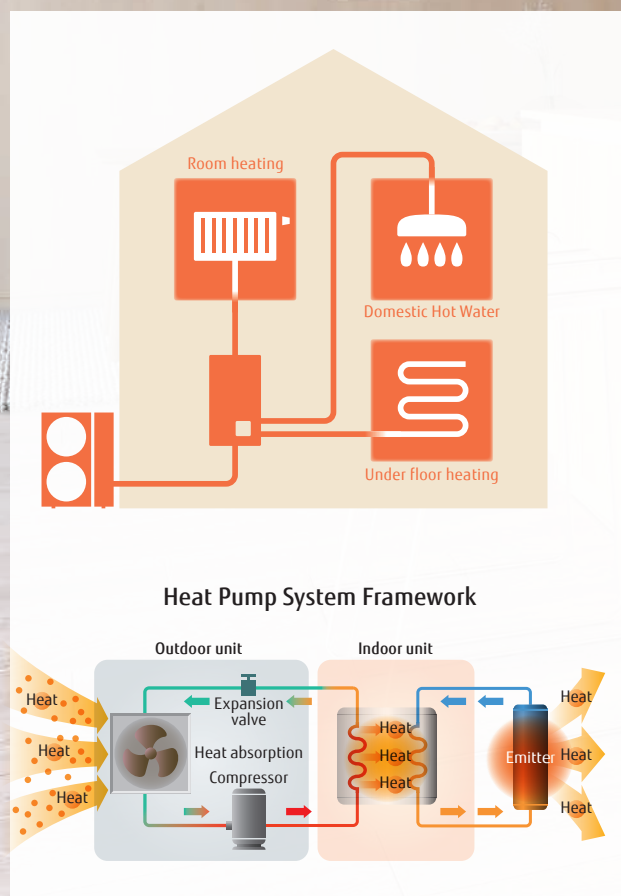

20 Models

Fujitsu General WATERSTAGE heat pumps offer a variety of high-efficiency renewable central heating systems that absorb energy primarily from the air.



Optimized refrigerant cycle operation

Super High Power and High Power Series deliver high performance and efficiency with twin sensors and hot water heating technology.

Split Type

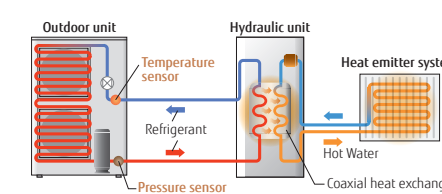

Split DHW Integrated Type

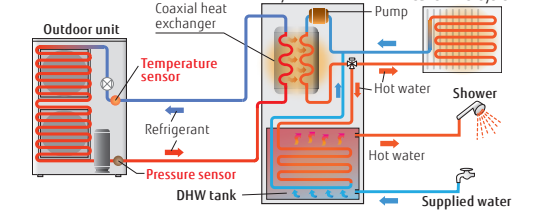

What is a heat pump?

A heat pump extracts heat energy from the atmosphere. It requires only 1 kW of electricity to generate 3 to 5 kW of thermal energy.

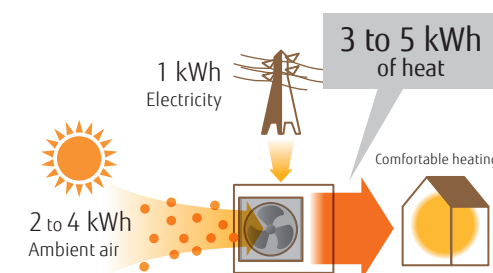

Primary energy usage reduced substantially

Proportion of primary energy converted into heating energy is 100%

Primary Energy Consumption*

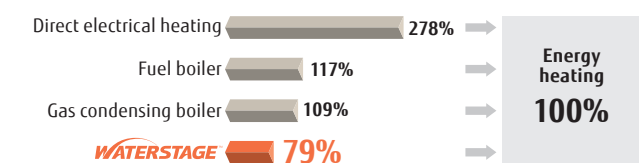

* The amount of electricity loss varies according to the power plant. Typical energy efficiency of a power plant: 36%

WATERSTAGE Lineup



Type	Split Type			Split DHW Integrated Type		
	Super High Power Series	High Power Series	Comfort Series	Super High Power Series	High Power Series	Comfort Series
Hydraulic unit						
Outdoor unit						
Capacity range	16 kW	11/14 kW 11/14/16 kW	5/6 kW 8 kW 10 kW	16 kW	11/14 kW 11/14/16 kW	5/6 kW 8 kW 10 kW
System outline	<ul style="list-style-type: none"> Supplies 60°C hot water even when the outdoor temperature is -20°C. Supplies 55°C hot water even when the outdoor temperature is -22°C. Can be used with a variety of heating systems, including underfloor heating and radiators.* Heating and DHW supply in one system.* Equipped with additional electric heater for backup Up to two independent control circuits.* Cooling operation is possible.* Operating range is -25 to 35°C. 	<ul style="list-style-type: none"> Supplies 60°C hot water even when the outdoor temperature is -20°C. Can be used with a variety of heating systems, including underfloor heating and radiators.* Heating and DHW supply in one system.* Up to two independent control circuits.* Cascade connection is possible for up to three systems.* Cooling operation is possible.* Operating range is -25 to 35°C. 	<ul style="list-style-type: none"> Supplies 55°C hot water even when the outdoor temperature is -10°C. Heating and DHW supply in one system.* Equipped with additional electric heater for backup Up to two independent control circuits.* Cooling operation is possible.* Operating range is -20 to 35°C. Can be used with a variety of heating systems, including underfloor heating and radiators.* 	<ul style="list-style-type: none"> Supplies 60°C hot water even when the outdoor temperature is -20°C. Supplies 55°C hot water even when the outdoor temperature is -22°C. Can be used with a variety of heating systems, including underfloor heating and radiators.* Space saving heating and DHW supply in a single Hydraulic unit Equipped with additional electric heater for backup Up to two independent control circuits.* Cooling operation is possible.* Operating range is -25 to 35°C. 	<ul style="list-style-type: none"> Supplies 60°C hot water even when the outdoor temperature is -20°C. Can be used with a variety of heating systems, including underfloor heating and radiators.* Space saving heating and DHW supply in a single Hydraulic unit Up to two independent control circuits.* Cooling operation is possible.* Operating range is -25 to 35°C. 	<ul style="list-style-type: none"> Supplies 55°C hot water even when the outdoor temperature is -10°C. Heating and DHW supply in one system. Equipped with additional electric heater for backup Up to two independent control circuits.* Cooling operation is possible.* Operating range is -20 to 35°C. Can be used with a variety of heating systems, including underfloor heating and radiators.*
Power source	Single phase, ~230 V, 50 Hz	Single phase, ~230 V, 50 Hz 3-phase, ~400 V, 50 Hz	Single phase, ~230 V, 50 Hz	Single phase, ~230 V, 50 Hz	Single phase, ~230 V, 50 Hz 3-phase, ~400 V, 50 Hz	Single phase, ~230 V, 50 Hz
Capacity	5 kW		WSHA050ML3 WOHA060KLT			WGHA050ML3 WOHA060KLT
	6 kW		WSHA080ML3 WOHA060KLT			WGHA080ML3 WOHA060KLT
	8 kW		WSHA080ML3 WOHA080KLT			WGHA080ML3 WOHA080KLT
	10 kW		WSHA100ML3 WOHA100KLT			WGHA100ML3 WOHA100KLT
	11 kW	WSHG140DG WOHG112LHT	WSHG140DG WOHK112LCTA			WGHG140DG WOHG112LHT
	14 kW	WSHG140DG WOHG140LCTA	WSHG140DG WOHK140LCTA			WGHG140DG WOHG140LCTA
	15 kW					
	16 kW	WSHG160DJ6 WOHG160JL	WSHG140DG WOHK160LCTA		WGHG160DJ6 WOHG160JL	WGHG140DG WOHK160LCTA
17 kW						

* Please refer to page W-036 and W-037 for optional parts information.

Benefits

Less
CO₂ Emissions

WATERSTAGE is an environmentally friendly system that emits substantially less carbon dioxide than conventional gas and hydrocarbon combustion systems.

Average annual CO₂ emissions

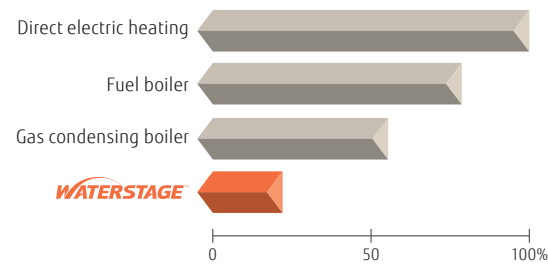

*Calculations based on energy efficiency data provided by the European Programme for Energy Efficiency in EU-27: 89% for fuel boilers; 93% for gas boiler

Low
Running Cost

High-efficiency heat pump technology keeps the running cost of a WATERSTAGE system.

Average annual running cost

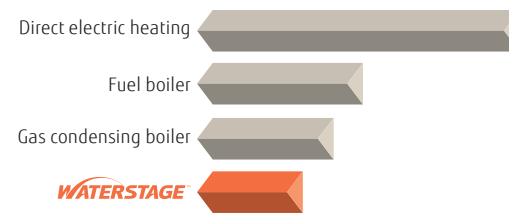

*The running cost may vary depending on a system's installation, geographical location, and operating conditions.

Clean
and Healthy

As a WATERSTAGE system does not use a burner to heat water, it does not produce NO_x or other harmful substances.



Environmentally friendly heating system



Easy
Installation and Maintenance

All components are built into a compact outdoor unit or a Hydraulic unit.



Well-designed Hydraulic unit
The sophisticated arrangement of Hydraulic units makes piping and maintenance work easy.

Energy Efficiency Standards Product labels

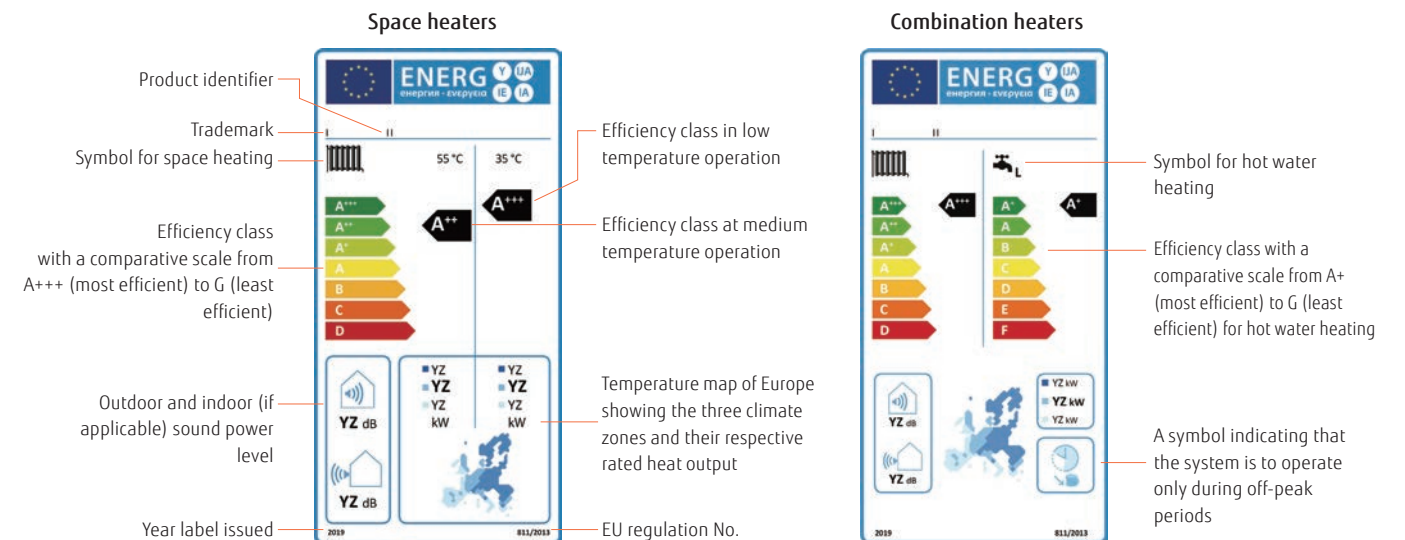

The Ecodesign Directive Lot 1 Regulation 813/2013

The Ecodesign directive defines a regulatory framework for improving the environmental performance of energy-related products (ErP) through design. Since September 26, 2015, the Ecodesign Directive has applied to space heaters, including heat pumps and fossil fuel fired boilers, combination heaters for space and hot water heating, water heaters, and water storage tanks.

All of these products must meet minimum requirements for energy efficiency*¹ and maximum sound power level. The minimum energy efficiency class were raised on September 26, 2017, and the maximum sound levels were lowered on September 26, 2018.

*1: Energy efficiency is expressed in terms of seasonal space heating efficiencies (η_s). The value is based upon the Seasonal Coefficient of Performance (SCOP).

The Energy Labelling Directive (EU) No. 811/2013

Energy label is intended to enable consumers to make direct comparisons of energy use and product features. All labels should indicate the product identifier, efficiency class, sound power level, and heat output. Heat generators are rated A+++ to D. There are two different product labels. One for space heaters and one for combination heaters.

Seasonal space heating Energy efficiency class

Class	Except low temp. HP 55°C	Low temp. HP 35°C
A+++	η _s ≥ 150	η _s ≥ 175
A++	125 ≤ η _s < 150	150 ≤ η _s < 175
A+	98 ≤ η _s < 125	123 ≤ η _s < 150
A	90 ≤ η _s < 98	115 ≤ η _s < 123
B	82 ≤ η _s < 90	107 ≤ η _s < 115
C	75 ≤ η _s < 82	100 ≤ η _s < 107
D	36 ≤ η _s < 75	61 ≤ η _s < 100
E	34 ≤ η _s < 36	59 ≤ η _s < 61
F	30 ≤ η _s < 34	55 ≤ η _s < 59
G	η _s < 30	η _s < 55

EHPA Quality Label



Fujitsu General's WATERSTAGE² has acquired the EHPA Quality Label³ through testing in accordance with the International Standards EN14511 and EN17025. The EHPA Quality Label³ is a label that shows the end-consumer a quality heat pump unit on the market.

*2: 3-phase High Power Series only
*3: Learn more about the validity of the mark at www.ehpa.org/quality/quality-label/

SG ready Label



SG ready is a label issued to heat pumps and their control technologies that meet the requirements set by BWP⁴, and technologies that conform to their standards can be integrated into a smart grid. SG ready labeled heat pumps receive signals from the power grid and PV systems with regard to energy and renewable energy sources such as wind, solar, and water. All of Fujitsu General's new heat pump series are SG ready compatible.

*4: BWP: Bundesverband Wärmepumpe e. V. (Federal German Heat Pump Association)

The CEN Heat Pump KEYMARK



The Heat Pump KEYMARK is a full certificate supporting the quality of heat pumps in the European market. The Heat Pump KEYMARK is a voluntary, independent, European certification mark (ISO Type 5 Certification) for all heat pumps, combination heat pumps, and hot water heaters (as covered by Ecodesign, EU Regulation 813/2013 and 814/2013). Fujitsu General's WATERSTAGE⁵ has acquired the KEYMARK certificate⁶.

*5: R32 refrigerant comfort model only
*6: Learn more about the validity of the mark at www.heatpumpkeymark.com/about/

Home Heating & Domestic Hot Water Supply

A wide range of products to suit regional characteristics, family structures, and usage patterns. We provide a variety of products to meet the needs of customers from the heating-centered High Power Series to the reasonably priced Compact Series.

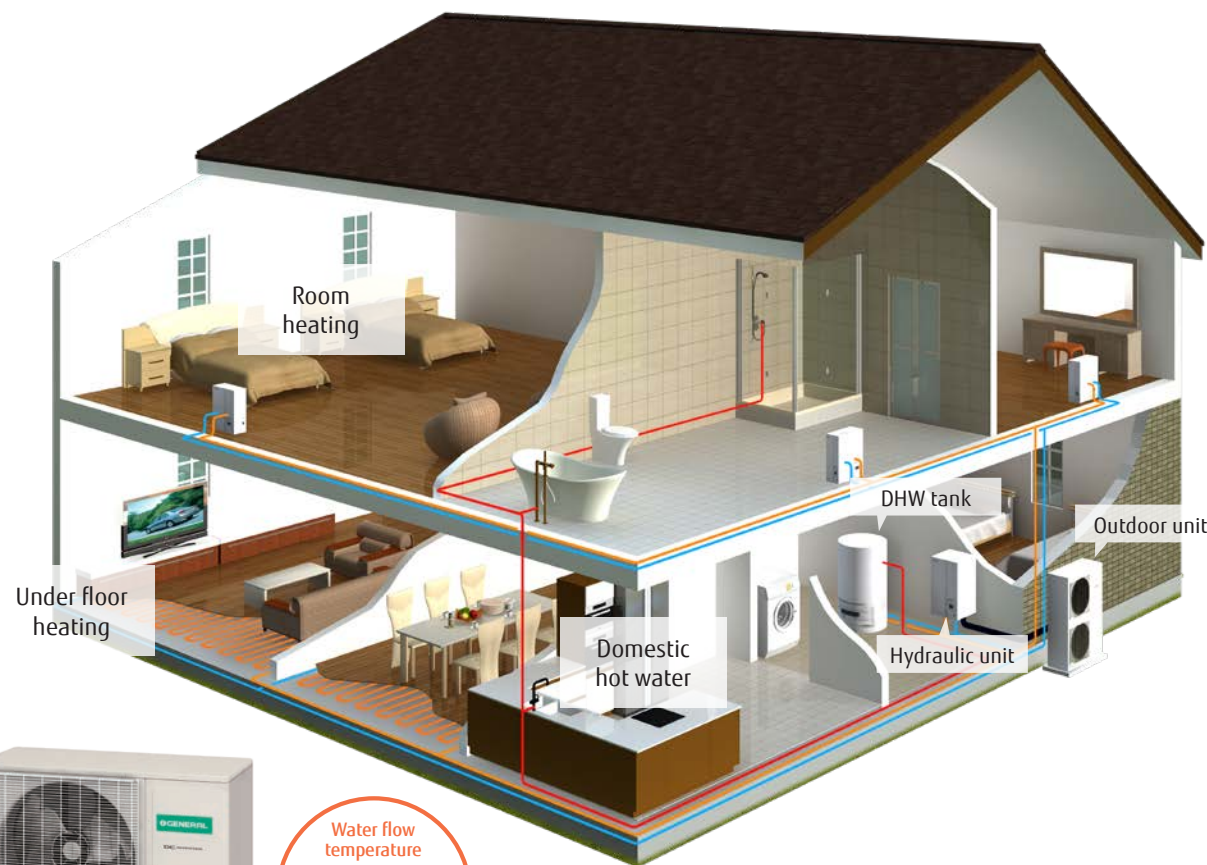

Water flow temperature
60°C

Super High Power Series
Single phase: 16 kW
3-phase: 15/17 kW

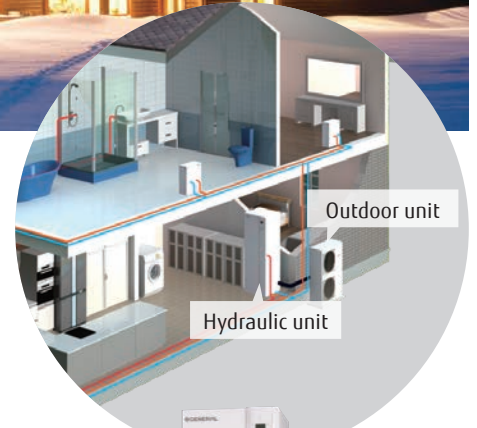

Adopting R32 refrigerant

R32 refrigerant is an environmentally friendly refrigerant with a significantly lower Global Warming Potential (GWP) than conventional refrigerants.

Stylish space saving solution with built-in DHW tank



Built-in DHW tank saves a great deal of space.

Existing boilers can be replaced easily. A higher heating capacity can be achieved with the flexibility to cascade more units.

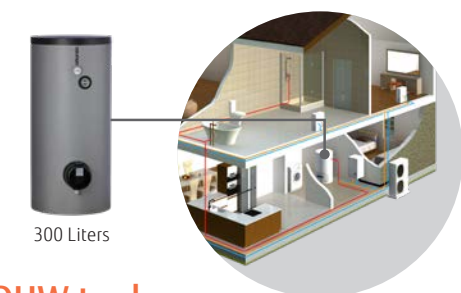

+ DHW tank

A DHW tank (optional) can be connected to supply hot water.

+ Boiler

By combining with an existing boiler, powerful heating can be achieved even at low outdoor temperature.

* Please refer to page W-036 and W-037 for optional parts information.

Floor heating and domestic hot water supply

Outdoor units and hydraulic indoor units can be installed flexibly and easily. Hydraulic units installed inside the house prevent the circulating water from freezing. More units can be cascaded together to provide a greater heating capacity with greater flexibility.¹

*1: High Power Series only

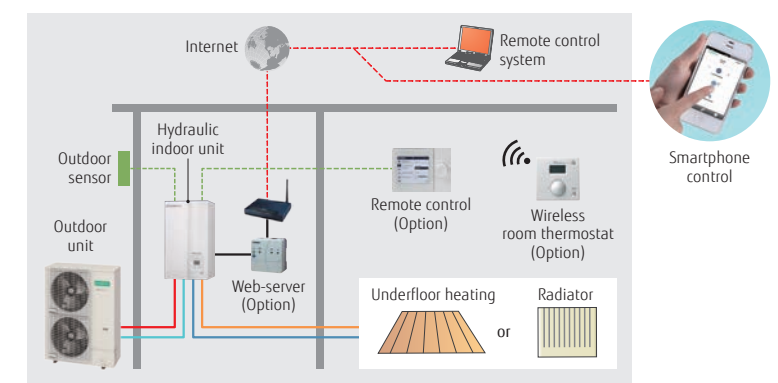

Smart control

To meet the diverse needs of customers, we offer a variety of control options, such as individual control and remote control options.

High-Efficiency Technology

Twin-Rotary Compressor



For Outdoor unit

Twin-Rotary Compressor with Linear Control Injection Port

The compressor achieves a high condensing temperature without overheating the discharge gas temperature due to the Linear control injection process used during compression. This makes the condensing temperature higher than in a normal circuit. Higher water temperatures can be achieved by controlling the injection volume according to usage conditions.

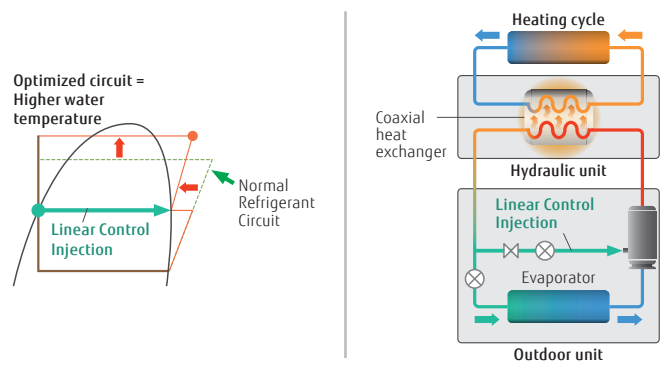

DC inverter technology controls temperatures precisely.

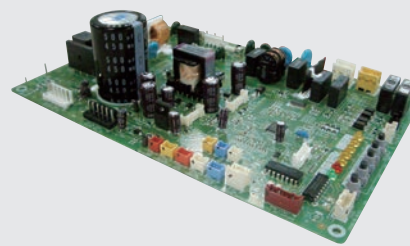
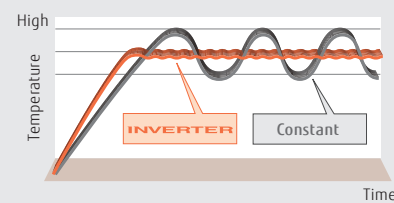

High-durability coaxial heat exchanger

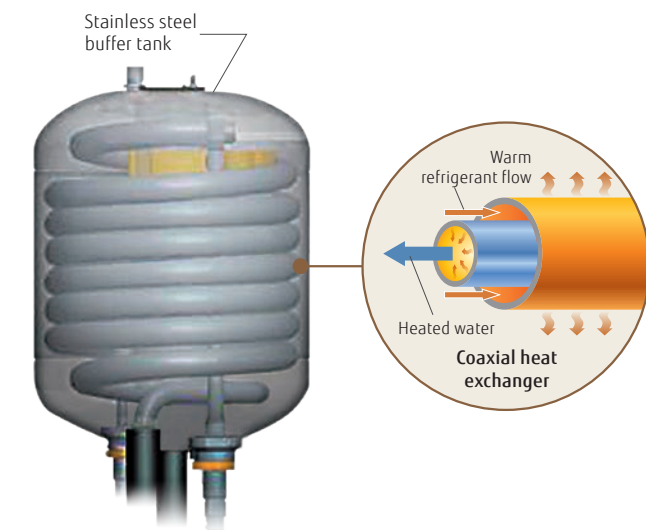

For Hydraulic unit

Stainless steel buffer tank

Heat exchange amount is 25% higher than the previous model. Energy-saving performance has also been improved.

- Anti-corrosion protection
- No flow switch required
- Anti-freeze protection not required

Class A Pump

Energy-saving pump with the ability to adjust the flow rate and pressure to a constant level



Split Type Comfort Series



High water flow temperature

The temperature of water flow is up to 55°C without a backup heater. Hot water supply temperature can be maintained even at -10°C outdoor temperature.

* If you want to raise the temperature of the water supply to above the maximum temperature, use a backup heater to supplement the primary heater.



High COP

Heat pumps of WATERSTAGE ATW Systems work more efficiently and consume less energy than conventional heating systems.

Energy efficiency class **A+++***

*Temperature application: Heating temp. 35°C

Seasonal space heating energy efficiency (η_s)
Conditions: Outdoor Temp. 7°C Heating Temp. 35°C

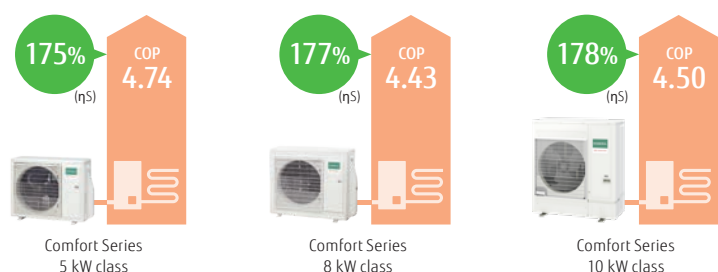

Outdoor unit technology



DC Fan Motor
High-performance, high-efficiency small DC fan motor mounted

DC Twin-Rotary Compressor
High-efficiency DC twin-rotary compressor

DC Inverter
DC inverter provides smooth water temperature control.

Hydraulic indoor unit:
WSHA050ML3 / WSHA080ML3 /
WSHA100ML3
Outdoor unit:
WOHA060KLT / WOHA080KLT /
WOHA100KLT



Specifications

Model Name	Hydraulic unit	Outdoor unit	WSHA050ML3 WOHA060KLT	WSHA080ML3 WOHA080KLT	WSHA080ML3 WOHA080KLT	WSHA100ML3 WOHA100KLT
Capacity Range			5	6	8	10
7°C/35°C floor heating *1	Heating capacity	kW	4.50	5.50	7.50	9.50
	Input power		0.949	1.18	1.69	2.11
	COP		4.74	4.65	4.43	4.50
2°C/35°C floor heating *1	Heating capacity	kW	4.50	5.30	6.30	9.30
	Input power		1.33	1.65	1.96	3.08
	COP		3.39	3.22	3.21	3.02
-7°C/35°C floor heating *1	Heating capacity	kW	4.40	5.00	5.70	8.90
	Input power		1.59	1.90	2.13	3.36
	COP		2.76	2.63	2.68	2.65
-7°C/55°C Radiator *1	Heating capacity	kW	3.90	4.25	5.30	8.00
	Input power		2.11	2.25	2.79	4.10
	COP		1.85	1.89	1.90	1.95

Space heating characteristics*2

Temperature application	°C	55	35	55	35	55	35	55	35
Energy efficiency class		A++	A+++	A++	A+++	A++	A+++	A++	A+++
Rated heat output (P _{rated})	kW	5	5	5	5	6	7	8	9
Seasonal space heating energy efficiency (η_s)	%	125	175	125	175	128	177	130	178
Annual energy consumption	kWh	3,035	2,322	3,411	2,594	3,903	2,982	5,083	3,875
Sound power level*3	Hydraulic unit								
	Outdoor unit	dB(A)	40	-	40	-	40	-	40

Hydraulic unit specifications

Power source	Single phase, ~230 V, 50 Hz								
Dimensions H × W × D	mm	847 × 450 × 493		847 × 450 × 493		847 × 450 × 493		847 × 450 × 493	
Weight (Net)	kg	47		47		47		47	
Water circulation	Min./Max.	L/min		7.6/22.0		8.5/22.0		10.0/22.0	
Buffer tank capacity	L	16		16		16		16	
Expansion vessel capacity	L	8		8		8		8	
Water flow temperature range	Max.	°C		55		55		55	
Water pipe connection diameter	Flow/Return	mm		Ø25.4/Ø25.4		Ø25.4/Ø25.4		Ø25.4/Ø25.4	
Backup heater	Capacity	kW		3.0		3.0		3.0	

Outdoor unit specifications

Power source	Single phase, ~230 V, 50 Hz					
Current	Max.	A	13.0	18.0	19.0	
Dimensions H × W × D	mm	632 × 799 × 290		632 × 799 × 290		
Weight (Net)	kg	39		42		
Refrigerant	Type (Global Warming Potential)	R32 (675)		R32 (675)		
	Charge	kg	0.97	0.97	1.02	
Additional refrigerant charge		g/m	25	25	20	
	Diameter	Liquid	mm	6.35	6.35	6.35
Connection pipe	Gas	mm	12.70	12.70	12.70	
	Length	Min./Max.	m	3/30	3/30	
	Length (Pre-charge)	m	15	15	15	
	Height difference	Max.	m	20	20	
Operating range	Heating	°C	-20 to 35		-20 to 35	

*1: Heating capacity, input power, and COP are measured using the EN14511 standard. Actual usage environments, such as the operating modes of the heating equipment, room temperature, and controller settings, may cause differences in values between those listed in the catalog and the actual performance characteristics.

*2: Information about ErP can be downloaded from our website at www.fujitsu-general.com/global/support/downloads/search/

*3: The sound power level values are based on EN12102 standard measurements under EN14825 standard conditions.

Dimensions

(Unit: mm)

Outdoor Unit:
WOHA060KLT

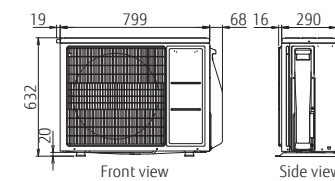

WOHA080KLT

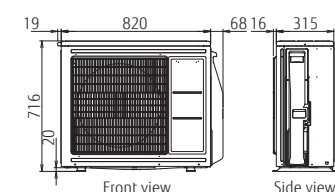

WOHA100KLT

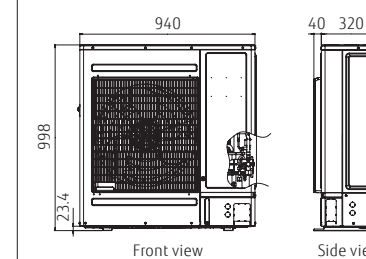

Hydraulic Indoor Unit:
WSHA050ML3/WSHA080ML3/WSHA100ML3

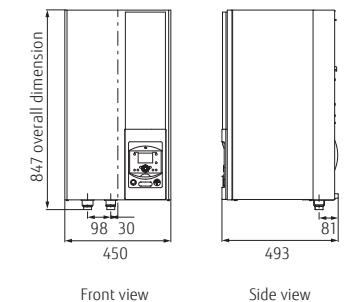

Split Type

Super High Power Series



High water flow temperature

The temperature of water flow can be maintained at 60°C without using a backup heater, even when the outdoor temperature drops to -20°C. The system can supply 55°C water without a backup heater at an outdoor temperature of -22°C.

* If you want to raise the temperature of the water supply to above the maximum temperature, use a backup heater to supplement the primary heater.

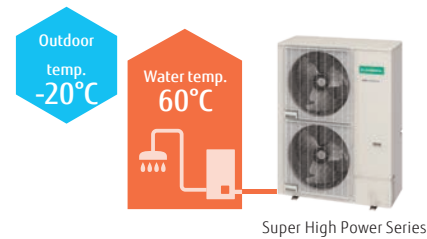

High COP

Heat pumps of WATERSTAGE ATW Systems work more efficiently and consume less energy than conventional heating systems.



Seasonal space heating energy efficiency (η_s)

Conditions: Outdoor Temp. 7°C Heating Temp. 35°C

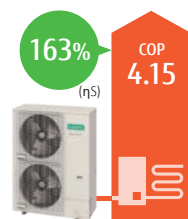

Single phase
16 kW class

Operating range extended to -25°C

Operating range improved down to -25°C outdoor temperature



Hydraulic indoor unit:
WSHG160DJ6
Outdoor unit:
WOHG160LJL



Specifications

Model Name	Hydraulic unit	Outdoor unit	WSHG160DJ6	WOHG160LJL
Capacity range				
7°C/35°C floor heating *1	Heating capacity	kW	16.00	16
	Input power		3.86	
	COP		4.15	
2°C/35°C floor heating *1	Heating capacity	kW	13.30	
	Input power		4.25	
	COP		3.13	
-7°C/35°C floor heating*1	Heating capacity	kW	14.50	
	Input power		5.27	
	COP		2.75	
-7°C/55°C Radiator*1	Heating capacity	kW	10.90	
	Input power		5.89	
	COP		1.85	
Space heating characteristics*2				
Temperature application	°C		55	35
Energy efficiency class			A++	A++
Rated heat output (P _{rated})	kW		14	16
Seasonal space heating energy efficiency (η _s)	%		125	163
Annual energy consumption	kWh		8,757	8,014
Sound power level	Hydraulic unit	dB(A)	45	45
	Outdoor unit		67	66
Hydraulic unit specifications				
Power source	Single phase, ~230 V, 50 Hz			
Dimensions H × W × D	mm	805 × 450 × 471		
Weight (Net)	kg	52.5		
Water circulation	Min./Max.	L/min	26.4/57.8	
Buffer tank capacity	L	22		
Expansion vessel capacity	L	10		
Water flow temperature range	Max.	°C	60	
Water pipe connection diameter	Flow/Return	mm	Ø25.4/Ø25.4	
Backup heater	Capacity	kW	6.0 (3.0 kW × 2 pcs.)	
Outdoor unit specifications				
Power source	Single phase, ~230 V, 50 Hz			
Current	Max.	A	28.0	
Dimensions H × W × D	mm	1,428 × 1,080 × 480		
Weight (Net)	kg	137		
Refrigerant	Type (Global Warming Potential)	R410A (2,088)		
	Charge	kg	3.80	
Additional refrigerant charge		g/m	50	
	Diameter	Liquid	mm	Ø9.52
Connection pipe		Gas	mm	Ø15.88
	Length	Min./Max.	m	5/30
	Length (Pre-charge)		m	15
	Height difference	Max.	m	25/15 (Outdoor unit: Upper/Lower)
Operating range	Heating	°C	-25 to 35	

*1: Heating capacity, input power, and COP are measured using the EN14511 standard. Actual usage environments, such as the operating modes of the heating equipment, room temperature, and controller settings, may cause differences in values between those listed in the catalog and the actual performance characteristics.
*2: Information about ErP can be downloaded from our website at www.fujitsu-general.com/global/support/downloads/search/

Dimensions

(Unit: mm)

Outdoor Unit:
WOHG160LJL

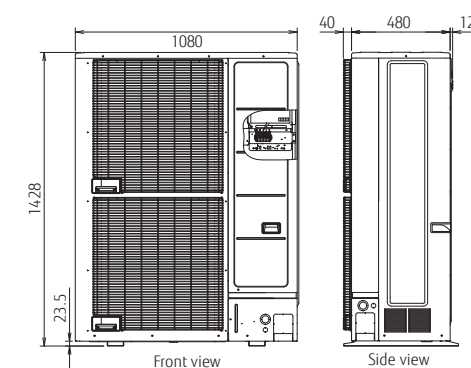

Hydraulic Indoor Unit:
WSHG160DJ6

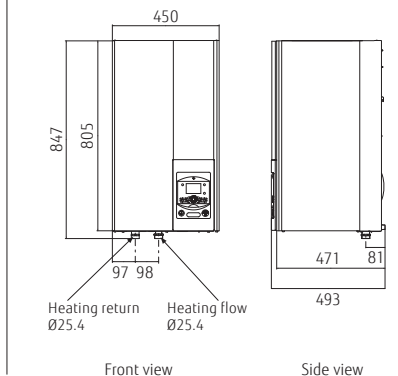

Split Type

High Power Series



High water flow temperature

The temperature of water flow can be maintained at 60°C without using a backup heater, even when the outdoor temperature drops to -20°C.

* If you want to raise the temperature of the water supply to above the maximum temperature, use a backup heater to supplement the primary heater.



High COP

Heat pumps of WATERSTAGE ATW Systems work more efficiently and consume less energy than conventional heating systems.



*Temperature application: Heating temp. 35°C

Seasonal space heating energy efficiency (η_s)

Conditions: Outdoor Temp. 7°C Heating Temp. 35°C

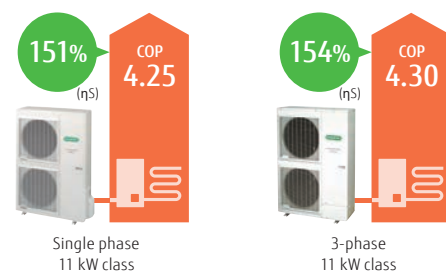

Hydraulic indoor unit:
WSHG140DG
Outdoor unit:
WOHG112LHT / WOHG140LCTA
[3 phase] WOHK112LCTA / WOHK140LCTA /
WOHK160LCTA



Specifications

Model Name	Hydraulic unit	WSHG140DG	WSHG140DG	WSHG140DG	WSHG140DG	WSHG140DG
	Outdoor unit	WOHG112LHT	WOHG140LCTA	WOHK112LCTA	WOHK140LCTA	WOHK160LCTA
Capacity range		11	14	11	14	16
7°C/35°C floor heating *1	Heating capacity	10.80	13.50	10.80	13.50	15.17
	Input power	2.54	3.23	2.51	3.20	3.70
	COP	4.25	4.18	4.30	4.22	4.10
2°C/35°C floor heating *1	Heating capacity	10.77	12.00	10.77	13.00	13.50
	Input power	3.44	3.87	3.40	4.15	4.34
	COP	3.13	3.10	3.17	3.13	3.11
-7°C/35°C floor heating*1	Heating capacity	10.38	11.54	10.38	12.20	13.50
	Input power	4.32	5.08	4.28	5.13	5.40
	COP	2.40	2.27	2.43	2.38	2.50
-7°C/55°C Radiator*1	Heating capacity	7.57	9.20	9.27	10.10	11.00
	Input power	4.57	5.08	5.09	5.65	6.29
	COP	1.66	1.81	1.82	1.79	1.75

Space heating characteristics*2

Temperature application	°C	55	35	55	35	55	35	55	35	55	35
Energy efficiency class		A+	A++	A+	A+	A+	A++	A+	A++	A+	A+
Rated heat output (P _{rated})	kW	9	11	11	13	9	11	11	13	13	14
Seasonal space heating energy efficiency (η _s)	%	112	151	113	148	112	154	117	150	117	149
Annual energy consumption	kWh	6,704	6,062	8,041	6,824	6,669	5,930	7,803	6,738	9,062	7,408
Sound power level	Hydraulic unit	46	46	46	46	46	46	46	46	46	46
	Outdoor unit	68	69	69	69	68	70	68	71	71	71

Hydraulic unit specifications

Power source		Single phase, ~230 V, 50 Hz	3-phase, ~400 V, 50 Hz
Dimensions H × W × D	mm	800 × 450 × 457	800 × 450 × 457
Weight (Net)	kg	40	40
Water circulation	Min./Max. L/min	19.5/39.0	24.4/48.7
Buffer tank capacity	L	16	16
Expansion vessel capacity	L	8	8
Water flow temperature range	Max. °C	60	60
Water pipe connection diameter	Flow/Return mm	Ø25.4/Ø25.4	Ø25.4/Ø25.4
Backup heater	Capacity kW	-	-

Outdoor unit specifications

Power source		Single phase, ~230 V, 50 Hz	3-phase, ~400 V, 50 Hz
Current	Max. A	22.0	25.0
Dimensions H × W × D	mm	1,290 × 900 × 330	1,290 × 900 × 330
Weight (Net)	kg	92	99
Refrigerant	Type (Global Warming Potential)	R410A (2,088)	
Additional refrigerant charge	Charge	kg	2.50
		g/m	50
Connection pipe	Diameter	Liquid mm	Ø9.52
		Gas mm	Ø15.88
	Length	Min./Max. m	5/20
	Length (Pre-charge)	m	15
Height difference	Max. m	15	
	Heating °C	-25 to 35	

*1: Heating capacity, input power, and COP are measured using the EN14511 standard. Actual usage environments, such as the operating modes of the heating equipment, room temperature, and controller settings, may cause differences in values between those listed in the catalog and the actual performance characteristics.
 *2: Information about ERp can be downloaded from our website at www.fujitsu-general.com/global/support/downloads/search/

Dimensions

(Unit: mm)

Outdoor Unit:
 Single phase: WOHG112LHT/WOHG140LCTA

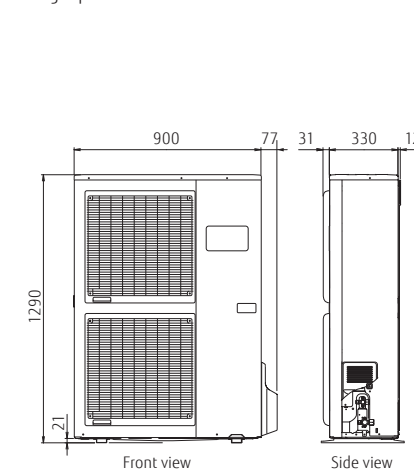

3 phase: WOHK112LCTA/WOHK140LCTA/WOHK160LCTA

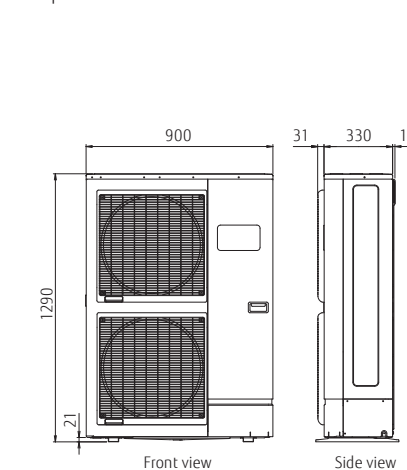

Hydraulic Indoor Unit:
 WSHG140DG

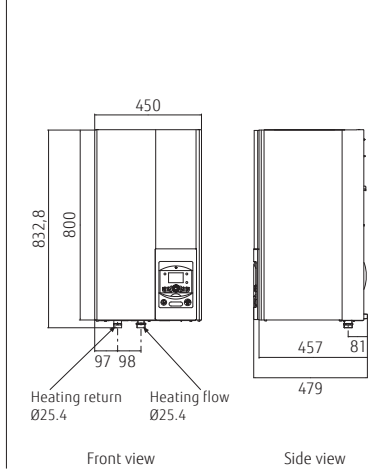

Split DHW Integrated Type

Comfort Series



Hydraulic indoor unit:
WGHA050ML3 / WGHA080ML3 / WGHA100ML3
Outdoor unit:
WOHA060KLT / WOHA080KLT / WOHA100KLT



Specifications

Model Name	Hydraulic unit	WGHA050ML3	WGHA080ML3	WGHA080ML3	WGHA100ML3	
	Outdoor unit	WOHA060KLT	WOHA060KLT	WOHA080KLT	WOHA100KLT	
Capacity range		5	6	8	10	
7°C/35°C floor heating *1	Heating capacity	4.50	5.50	7.50	9.50	
	Input power	0.949	1.18	1.69	2.11	
	COP	4.74	4.65	4.43	4.50	
2°C/35°C floor heating *1	Heating capacity	4.50	5.30	6.30	9.30	
	Input power	1.33	1.65	1.96	3.08	
	COP	3.39	3.22	3.21	3.02	
-7°C/35°C floor heating *1	Heating capacity	4.40	5.00	5.70	8.90	
	Input power	1.59	1.90	2.13	3.36	
	COP	2.76	2.63	2.68	2.65	
-7°C/55°C Radiator *1	Heating capacity	3.90	4.25	5.30	8.00	
	Input power	2.11	2.25	2.79	4.10	
	COP	1.85	1.89	1.90	1.95	
Space heating characteristics**						
Temperature application	°C	55	35	55	35	
Energy efficiency class		A++	A+++	A++	A+++	
Rated heat output (P _{rated})	kW	5	5	6	7	
Seasonal space heating energy efficiency (η _s)	%	125	175	128	177	
Annual energy consumption	kWh	3,035	2,322	3,411	2,594	
Sound power level*3	Hydraulic unit	40	-	40	-	
	Outdoor unit	57	-	57	-	
Domestic hot water characteristics**						
Load profile		L	L	L	L	
Energy efficiency class		A+	A+	A+	A+	
Energy efficiency (η _{wh})	%	130	130	130	130	
Annual electricity consumption	kWh	793	793	793	793	
Hydraulic unit specifications						
Power source		Single phase, ~230 V, 50 Hz				
Dimensions H × W × D	mm	1,863 × 648 × 700	1,863 × 648 × 700	1,863 × 648 × 700	1,863 × 648 × 700	
Weight (Net)	kg	145	145	145	145	
Water circulation	Min./Max. L/min	7.6/22.0	8.5/22.0	10.0/22.0	13.2/30.0	
DHW capacity	L	190	190	190	190	
Electrical heater capacity	Heating	3.0	3.0	3.0	3.0	
	DHW	1.5	1.5	1.5	1.5	
Buffer tank capacity	L	16	16	16	16	
Expansion vessel capacity	L	8	8	8	8	
Water flow temperature range	Max. °C	55	55	55	55	
Water pipe connection diameter	Flow/Return mm	Ø25.4/Ø25.4	Ø25.4/Ø25.4	Ø25.4/Ø25.4	Ø25.4/Ø25.4	
Hot water pipe connection diameter	mm	Ø19.05	Ø19.05	Ø19.05	Ø19.05	
Outdoor unit specifications						
Power source		Single phase, ~230 V, 50 Hz				
Current	Max. A	13.0	13.0	18.0	19.0	
Dimensions H × W × D	mm	632 × 799 × 290	632 × 799 × 290	716 × 820 × 315	998 × 940 × 320	
Weight (Net)	kg	39	39	42	62	
Refrigerant	Type (Global Warming Potential)	R32 (675)				
	Charge	kg	0.97	0.97	1.02	1.63
Additional refrigerant charge		g/m	25	25	20	
	Diameter	Liquid	6.35	6.35	6.35	9.52
Connection pipe		Gas	12.70	12.70	12.70	15.88
	Length	Min./Max.	3/30	3/30	3/30	3/30
	Length (Pre-charge)	m	15	15	15	20
	Height difference	Max. m	20	20	20	20
Operating range	Heating	°C	-20 to 35	-20 to 35	-20 to 35	-20 to 35

High water flow temperature

The temperature of water flow is up to 55°C without a backup heater. Hot water supply temperature can be maintained even at -10°C outdoor temperature.



* If you want to raise the temperature of the water supply to above the maximum temperature, use a backup heater to supplement the primary heater.

High COP

Heat pumps of WATERSTAGE ATW Systems work more efficiently and consume less energy than conventional heating systems.

Energy efficiency class **A+++***

*Temperature application: Heating temp. 35°C

Seasonal space heating energy efficiency (η_s)

Conditions: Outdoor Temp. 7°C Heating Temp. 35°C

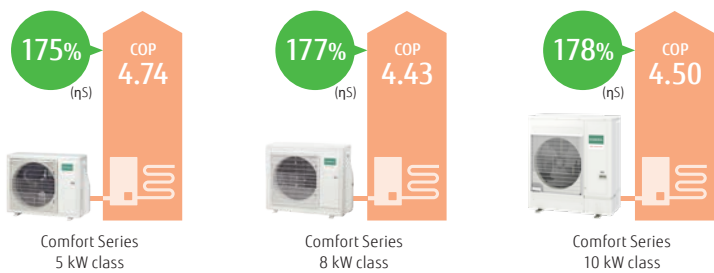

Outdoor unit technology



DC Fan Motor
High-performance, high-efficiency small DC fan motor mounted

DC Twin-Rotary Compressor
High-efficiency DC twin-rotary compressor

DC Inverter
DC inverter provides smooth water temperature control.

*1: Heating capacity, input power, and COP are measured using the EN14511 standard. Actual usage environments, such as the operating modes of the heating equipment, room temperature, and controller settings, may cause differences in values between those listed in the catalog and the actual performance characteristics.
*2: Information about ErP can be downloaded from our website at www.fujitsu-general.com/global/support/downloads/search/
*3: The sound power level values are based on EN12102 standard measurements under EN14825 standard conditions.

Dimensions

(Unit: mm)

Outdoor Unit:
WOHA060KLT

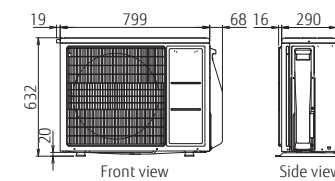

WOHA080KLT

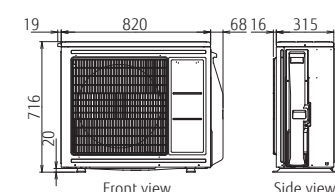

WOHA100KLT

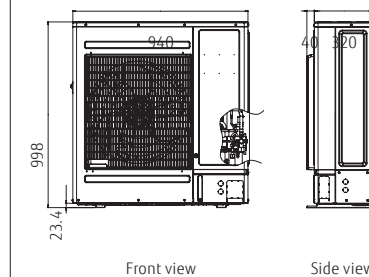

Hydraulic Indoor Unit:
WGHA050ML3/WGHA080ML3/WGHA100ML3

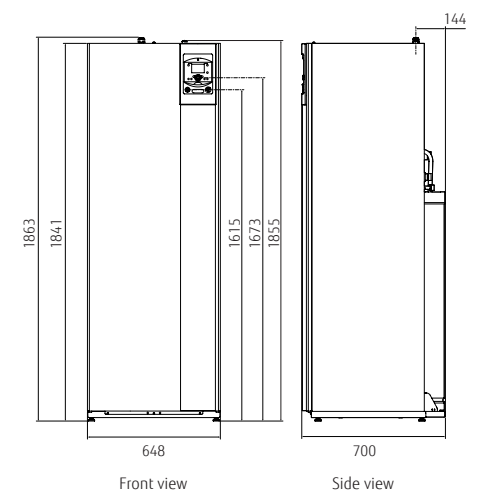

Split DHW Integrated Type

Super High Power Series



High water flow temperature

The temperature of water flow can be maintained at 60°C without using a backup heater, even when the outdoor temperature drops to -20°C. The system can supply 55°C water without a backup heater at an outdoor temperature of -22°C.

* If you want to raise the temperature of the water supply to above the maximum temperature, use a backup heater to supplement the primary heater.

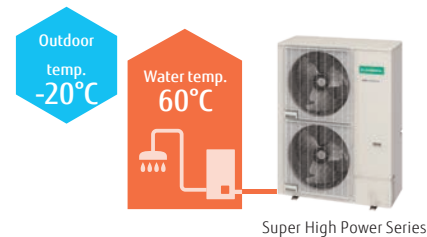

High COP

Heat pumps of WATERSTAGE ATW Systems work more efficiently and consume less energy than conventional heating systems.

Energy efficiency class



Seasonal space heating energy efficiency (η_s)

Conditions: Outdoor Temp. 7°C Heating Temp. 35°C

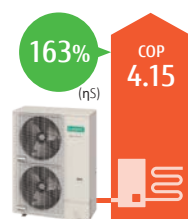

Single phase 16 kW class

Operating range extended to -25°C

Operating range improved down to -25°C outdoor temperature

Stylish space saving solution with **Built-in High-performance DHW tank 190 L**

- Coil heat exchanger optimizes DHW supply performance.
- Temperature rises quickly due to the large surface of the exchanger.

Hydraulic indoor unit:

WGHG160DJ6

Outdoor unit:

WOHG160LJL



Hydraulic unit
Single phase



Outdoor unit
Single phase 16 kW

Specifications

Model Name	Hydraulic unit	WGHG160DJ6	WOHG160LJL
Capacity range		16	
7°C/35°C floor heating *1	Heating capacity	16.00	
	Input power	3.86	
	COP	4.15	
2°C/35°C floor heating *1	Heating capacity	13.30	
	Input power	4.25	
	COP	3.13	
-7°C/35°C floor heating*1	Heating capacity	14.50	
	Input power	5.27	
	COP	2.75	
-7°C/55°C Radiator*1	Heating capacity	10.90	
	Input power	5.89	
	COP	1.85	
Space heating characteristics**			
Temperature application	°C	55	35
Energy efficiency class		A++	A++
Rated heat output (P _{rated})	kW	14	16
Seasonal space heating energy efficiency (η _s)	%	125	163
Annual energy consumption	kWh	8,757	8,014
Sound power level	Hydraulic unit	45	45
	Outdoor unit	67	66
Domestic hot water characteristics**			
Load profile		L	
Energy efficiency class		A	
Energy efficiency (η _{wh})	%	109	
Annual electricity consumption	kWh	941	
Hydraulic unit specifications			
Power source		Single phase, ~230 V, 50 Hz	
Dimensions H × W × D	mm	1,841 × 648 × 698	
Weight (Net)	kg	166	
Water circulation	Min./Max.	L/min	
DHW capacity	L	26.4/57.8	
Electrical heater capacity	Heating	190	
	DHW	6.0 (3.0 kW × 2 pcs.)	
Buffer tank capacity	L	1.5	
Expansion vessel capacity	L	22	
Water flow temperature range	Max.	12	
Water pipe connection diameter	Flow/Return	60	
Hot water pipe connection diameter		Ø25.4/Ø25.4	
		Ø19.05	
Outdoor unit specifications			
Power source		Single phase, ~230 V, 50 Hz	
Current	Max.	A	
Dimensions H × W × D	mm	28.0	
Weight (Net)	kg	1,428 × 1,080 × 480	
Refrigerant	Type (Global Warming Potential)	137	
Additional refrigerant charge	Charge	R410A (2,088)	
		3.80	
Connection pipe	Diameter	Liquid	50
		Gas	Ø9.52
Length	Min./Max.	m	Ø15.88
	Length (Pre-charge)	m	5730
	Height difference	Max.	m
Operating range	Heating	°C	25/15 (Outdoor unit: Upper/Lower)
			-25 to 35

*1: Heating capacity, input power, and COP are measured using the EN14511 standard. Actual usage environments, such as the operating modes of the heating equipment, room temperature, and controller settings, may cause differences in values between those listed in the catalog and the actual performance characteristics.
*2: Information about ErP can be downloaded from our website at www.fujitsu-general.com/global/support/downloads/search/

Dimensions

(Unit: mm)

Outdoor Unit:
WOHG160LJL

Hydraulic Indoor Unit:
WGHG160DJ6

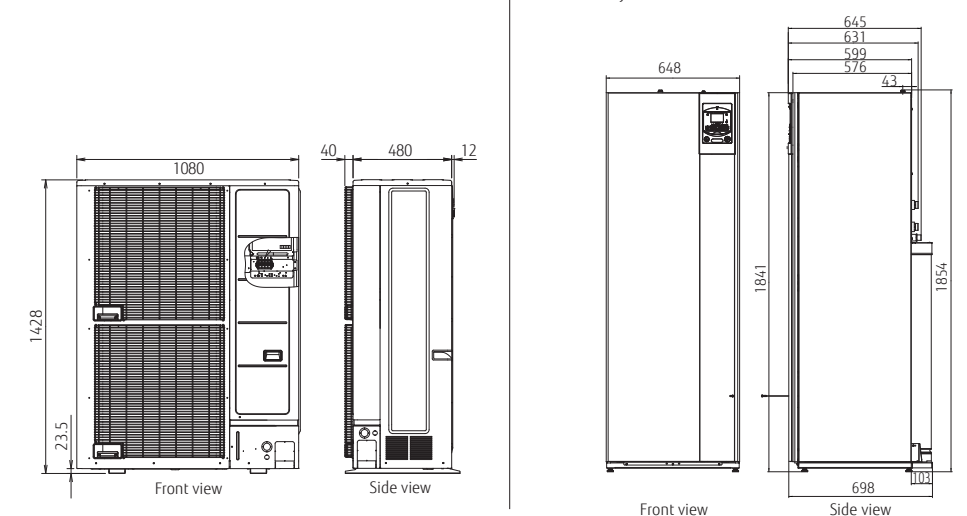

Split DHW Integrated Type

High Power Series



High water flow temperature

The temperature of water flow can be maintained at 60°C without using a backup heater, even when the outdoor temperature drops to -20°C.

* If you want to raise the temperature of the water supply to above the maximum temperature, use a backup heater to supplement the primary heater.



High COP

Heat pumps of WATERSTAGE ATW Systems work more efficiently and consume less energy than conventional heating systems.



*Temperature application: Heating temp. 35°C

Seasonal space heating energy efficiency (η_s)

Conditions: Outdoor Temp. 7°C Heating Temp. 35°C

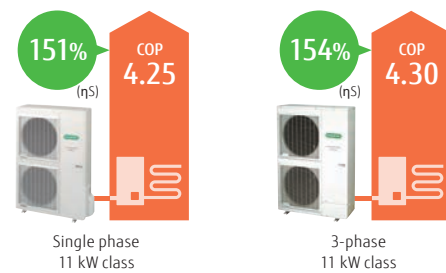

Optimized refrigerant cycle operation

The High Power Series deliver high performance and efficiency with twin sensors and hot water heating technology.

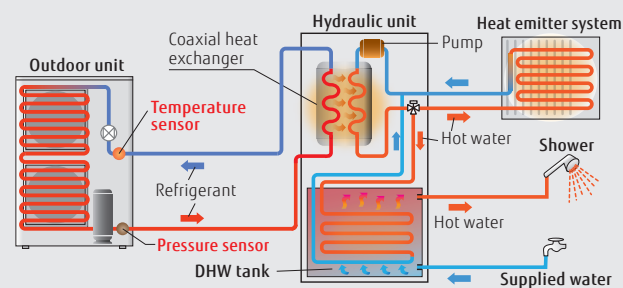

Hydraulic indoor unit:
WGHG140DG
Outdoor unit:
WOHG112LHT / WOHG140LCTA
[3 phase] WOHK112LCTA / WOHK140LCTA / WOHK160LCTA



Specifications

Model Name	Hydraulic unit		WGHG140DG		WGHG140DG		WGHG140DG		WGHG140DG	
	Outdoor unit		WOHG112LHT	WOHG140LCTA	WOHK112LCTA	WOHK140LCTA	WOHK140LCTA	WOHK140LCTA	WOHK160LCTA	
Capacity range			11	14	11	14	14	16		
7°C/35°C floor heating *1	Heating capacity	kW	10.80	13.50	10.80	13.50	13.50	15.17		
	Input power		2.54	3.23	2.51	3.20	3.70			
	COP		4.25	4.18	4.30	4.22	4.10			
2°C/35°C floor heating *1	Heating capacity	kW	10.77	12.00	10.77	13.00	13.50			
	Input power		3.44	3.87	3.40	4.15	4.34			
	COP		3.13	3.10	3.17	3.13	3.11			
-7°C/35°C floor heating*1	Heating capacity	kW	10.38	11.54	10.38	12.20	13.50			
	Input power		4.32	5.08	4.28	5.13	5.40			
	COP		2.40	2.27	2.43	2.38	2.50			
-7°C/55°C Radiator*1	Heating capacity	kW	7.57	9.20	9.27	10.10	11.00			
	Input power		4.57	5.08	5.09	5.65	6.29			
	COP		1.66	1.81	1.82	1.79	1.75			
Space heating characteristics*2										
Temperature application	°C		55	35	55	35	55	35	55	35
Energy efficiency class			A+	A++	A+	A+	A+	A++	A+	A+
Rated heat output (P _{rated})	kW		9	11	11	13	9	11	13	14
Seasonal space heating energy efficiency (η _s)	%		112	151	113	148	112	154	117	149
Annual energy consumption	kWh		6,704	6,062	8,041	6,824	6,669	5,930	7,803	6,738
Sound power level	Hydraulic unit	dB(A)	46		46		46		46	
	Outdoor unit		68		69		69		68	
Domestic hot water characteristics*2										
Load profile			L							
Energy efficiency class			A							
Energy efficiency(η _{dw})	%		88							
Annual electricity consumption	kWh		1166							
Hydraulic unit specifications										
Power source	Single phase, ~230 V, 50 Hz				3-phase, ~400 V, 50 Hz					
Dimensions H × W × D	mm				1,840 × 648 × 698					
Weight (Net)	kg				150					
Water circulation	Min./Max.	L/min	19.5/39.0		24.4/28.7		19.5/39.0		24.4/48.7	
DHW capacity	L		190							
Electrical heater capacity	Heating	kW	-							
	DHW		1.5							
Buffer tank capacity	L		16							
Expansion vessel capacity	L		12							
Water flow temperature range	Max.	°C	60							
Water pipe connection diameter	Flow/Return	mm	Ø25.4/Ø25.4							
Hot water pipe connection diameter	mm		Ø19.05							
Outdoor unit specifications										
Power source	Single phase, ~230 V, 50 Hz				3-phase, ~400 V, 50 Hz					
Current	Max.	A	22.0		25.0		9.0		10.5	
Dimensions H × W × D	mm				1,290 × 900 × 330					
Weight (Net)	kg				92					
Refrigerant	Type (Global Warming Potential)			R410A (2,088)						
	Charge	kg			2.50					
Additional refrigerant charge		g/m			50					
	Diameter	Liquid	mm		Ø9.52					
Connection pipe	Gas	mm		Ø15.88						
	Length	Min./Max.	m		5/20					
	Length (Pre-charge)	m		15						
	Height difference	Max.	m		15					
Operating range	Heating	°C			-25 to 35					

*1: Heating capacity, input power, and COP are measured using the EN14511 standard. Actual usage environments, such as the operating modes of the heating equipment, room temperature, and controller settings, may cause differences in values between those listed in the catalog and the actual performance characteristics.
 *2: Information about ErP can be downloaded from our website at www.fujitsu-general.com/global/support/downloads/search/

Dimensions

(Unit: mm)

Outdoor Unit:

Single phase: WOHG112LHT/WOHG140LCTA

3 phase: WOHK112LCTA/WOHK140LCTA/WOHK160LCTA

Hydraulic Indoor Unit:

WGHG140DG

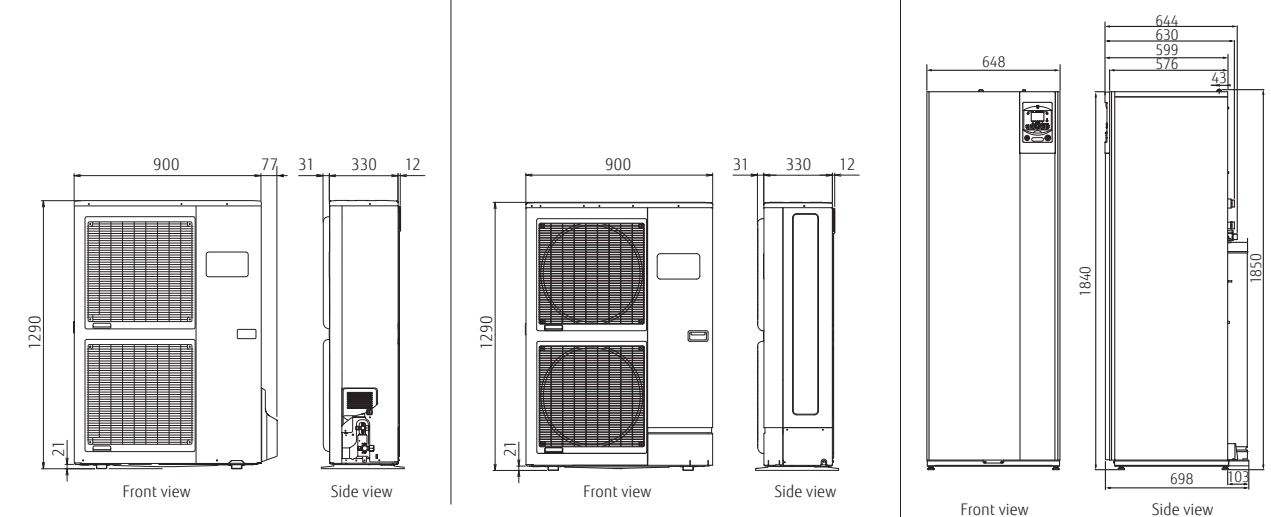

Control Overview

To meet the diverse needs of customers, we offer a variety of control options, such as individual control and remote control options.

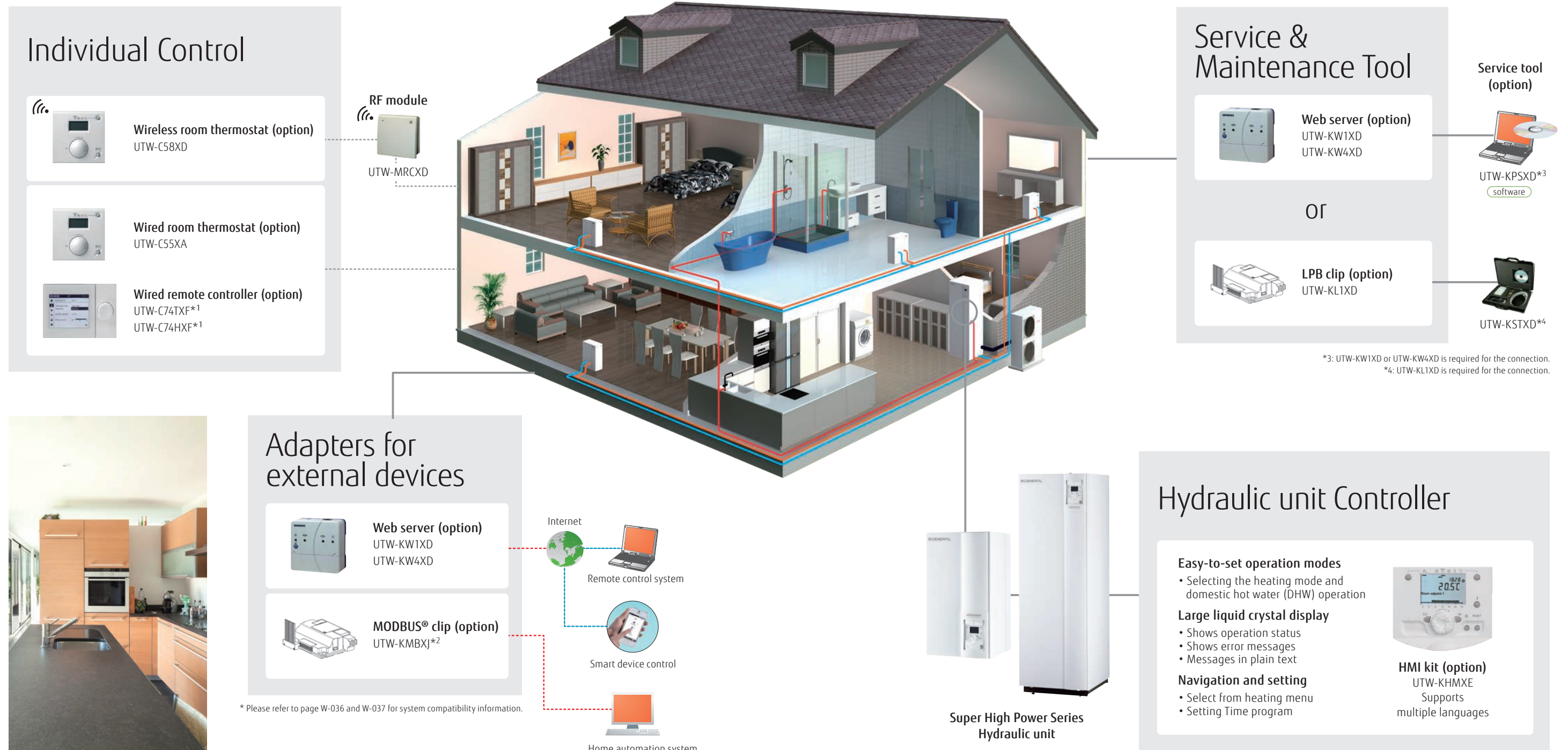

Comfort Control

The high-grade heating controller automatically adjusts the flow temperature according to the climate conditions to maintain the room and domestic hot water temperatures at the desired levels.

Hydraulic unit Controller 4 Heating modes

- 1. Automatic mode**
Enables automatic switching between Comfort mode and Reduce mode according to time program
- 2. Reduce mode**
Maintains water temperature at a lower level
- 3. Comfort mode**
Maintains water temperature at a comfortable level
- 4. Protection mode**
Activates frost protection in standby operation



Useful Features

Automatic heating curve control

Automatic temperature regulation according to heating curve (depending on heating terminal and outdoor temperature)

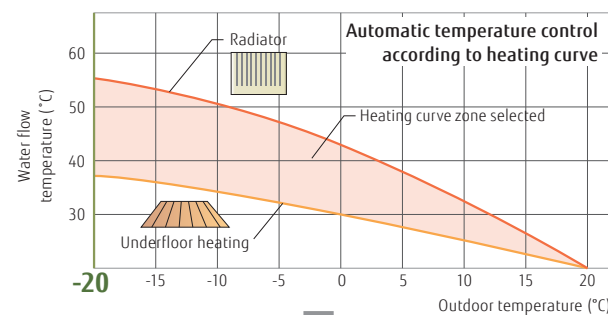

The heating curve will shift to adjust the room temperature setting.

Can be fine-adjusted when it is too warm or too cold.

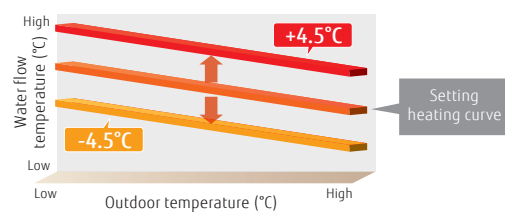

Quick recovery from defrosting

Maintains room temperature by boost start operation during defrosting.

Auto changeover

When cooling mode is selected, the system automatically switches between cooling and heating modes depending on the outdoor temperature to serve as an all-season air conditioner.

2-zone independent control

2-zone independent control (For example, the individual control of 2 underfloor heating zones or the combination of 1 underfloor heating zone and 1 radiator zone)*1

*1: Optional parts required

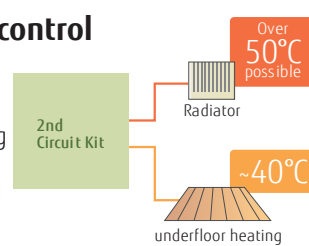

2-stage low-noise mode

The outdoor unit can be switched to quiet mode, depending on the installation environment.

*Effective only for High Power Series

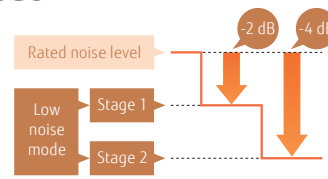

Backup heater operation

Backup heater maintains a comfortable room temperature even when the outside temperature is low. The backup heater is intelligently controlled as a safety backup for very cold days and nights, and only operates when really needed.

* Optional parts is needed for High power Series.

Energy Saving

Time program

- The timer is easy to set.
- You can select the heating mode in conjunction with various times of the day.

Day-weekly timer

- Allows up to 3 settings per day.
- Allows individual settings for each day of the week.

Holiday timer

- Allows up to 8 settings.
- While you are away from home for an extended period during winter, the system prevents your room or house from freezing.

Peak cut Function*2

Sets the peak current value to reduce power consumption.

Mode	Ratio to reduce power consumption
1	100%
2	75%
3	50%
4	Almost 0%

* Please refer to page W-036 and W-037 for optional parts information.

Safety Features

Anti-Legionella function

Prevents the growth of Legionella bacteria in the DHW tank to supply safe and clean hot water at all times.



Anti-freeze function

When the outside temperature drops below a specified level, the compressor will self-activate and water will also be automatically circulated to prevent freezing.

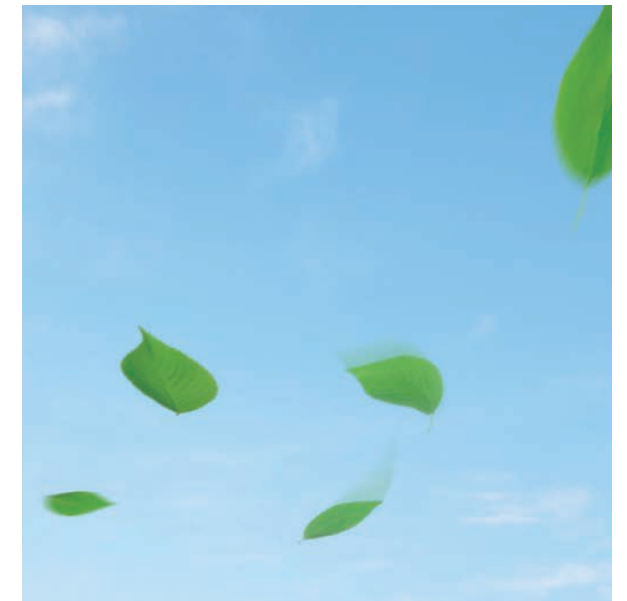
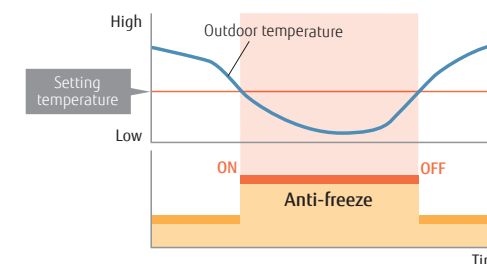

Emergency operation

If an outdoor unit fails to operate, a built-in backup heater or an external boiler is activated to supply an uninterrupted supply of hot water to the house.

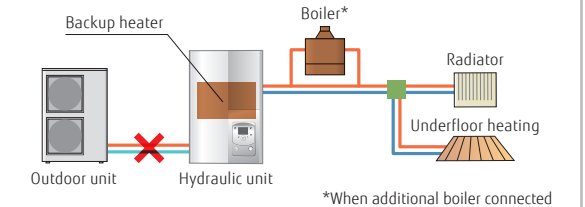

Error and Maintenance Alarm

Enables quick error-handling services and maintenance



- Error history saves 10 errors in memory
- Display telephone number of service company

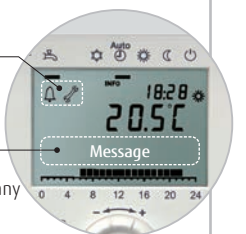

System Configuration

Split Type

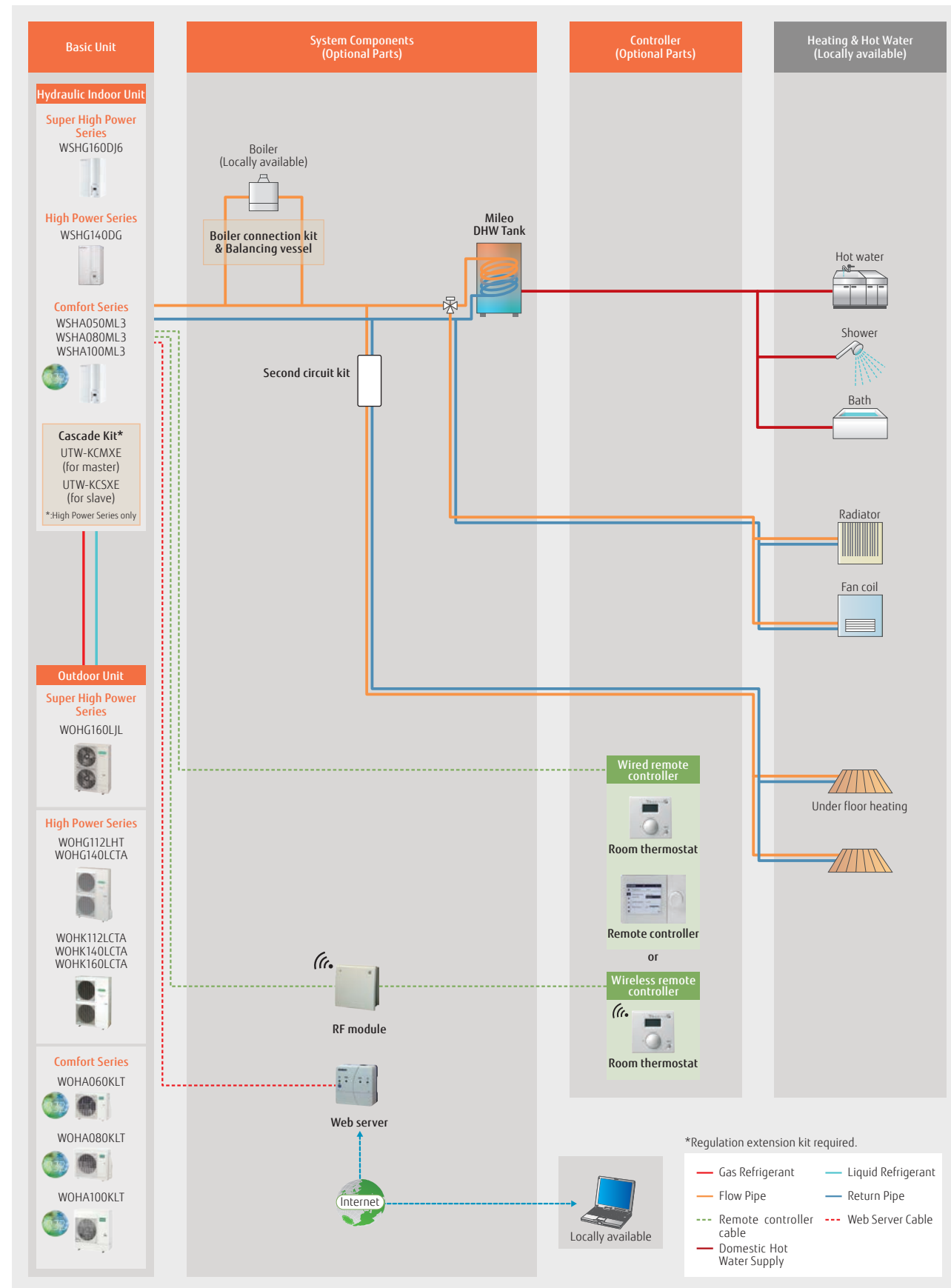

Split DHW Integrated Type

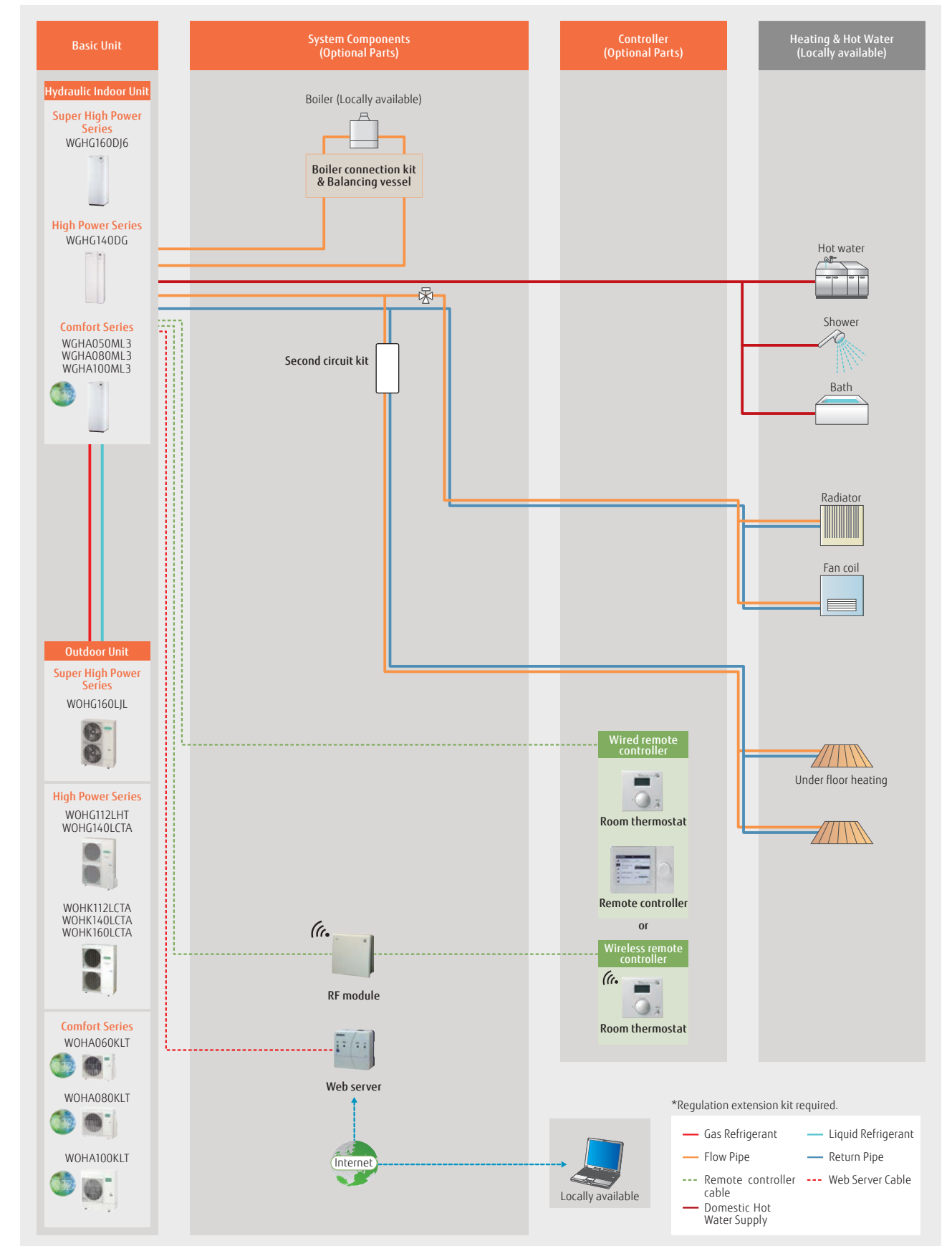

Case Studies

Split Type

2-emitter simultaneous heating (Individual control)
Underfloor heating + Radiator

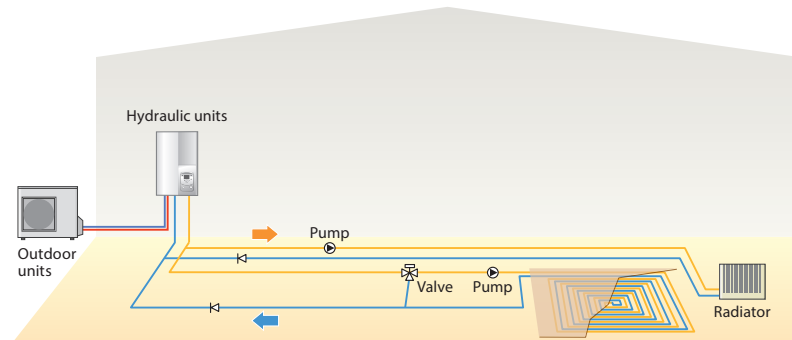

Boiler connected to heating (Boiler + Heating)

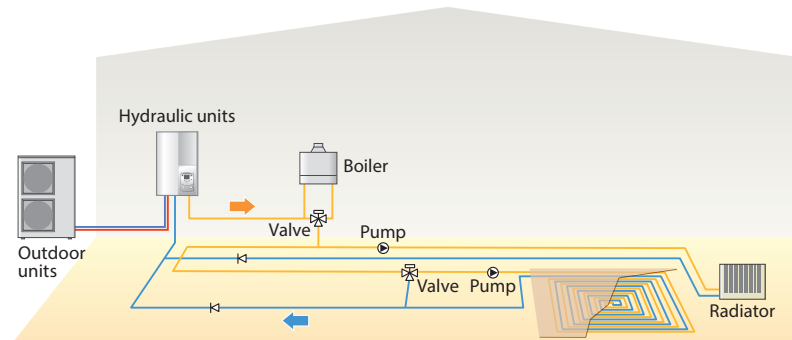

2-emitter simultaneous heating & domestic hot water supply (Cascade)

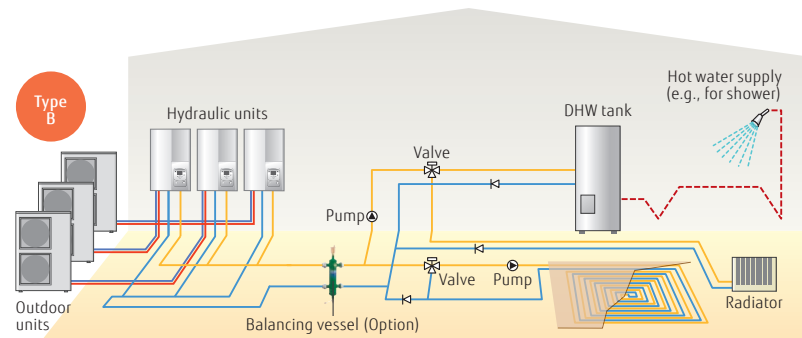
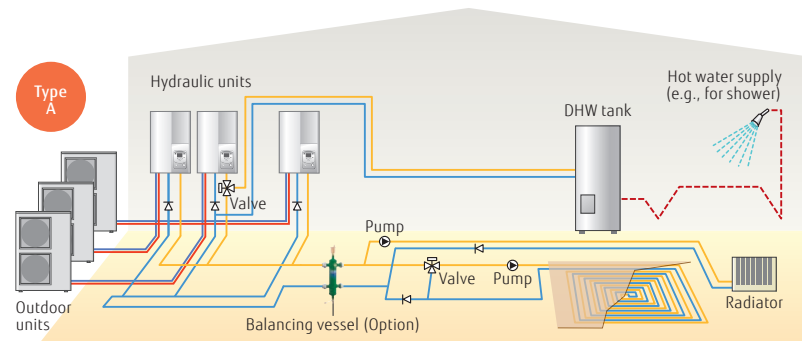

*The hydraulic layouts shown are mainly representation. Please check with local dealer for actual hydraulic connections.

Split DHW Integrated Type

Single heating & domestic hot water supply
Radiator + domestic hot water supply

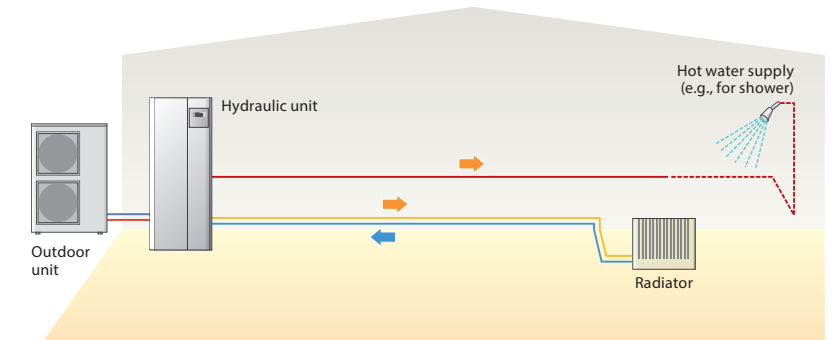

2-emitter simultaneous heating (Individual control) & domestic hot water supply
Radiator + domestic hot water supply

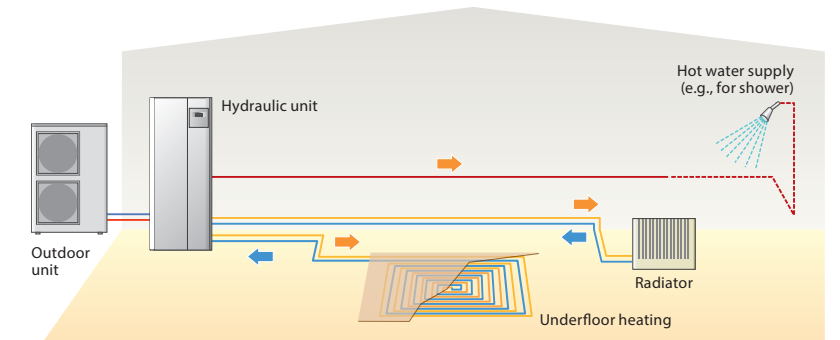

Boiler connected to heating (Boiler + Heating) and domestic hot water supply

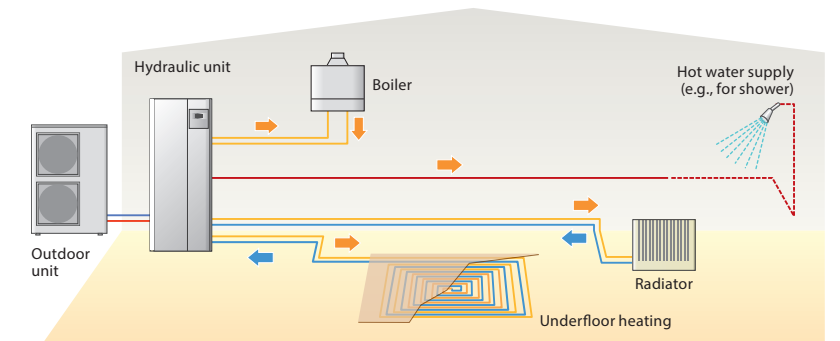

*The hydraulic layouts shown are mainly representation. Please check with local dealer for actual hydraulic connections.

Simple installation

Presetting configurations

A controller installed makes it easy to configure the system without having to set each component or unit individually.

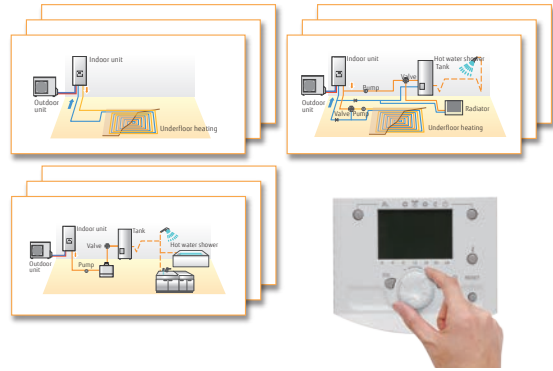

8 simple patterns for system presetting (Duo heating: 12 patterns)

Configuration (Parameter 5700)	Installation type
Presetting 1	1 heating circuit
Presetting 2	2 heating circuits
Presetting 3	1 heating circuit with boiler backup
Presetting 4	2 heating circuits with boiler backup
Presetting 5	1/2 heating circuit with buffer control
Presetting 6	1/2 heating circuit with buffer control and boiler backup
Presetting 7	Cascade connection Primary
Presetting 8	Cascade connection A
Presetting 9	Cascade connection B/C

- DHW & solar control auto detection
- Cascade connection only available in High Power models.

Outdoor temperature simulation

It verifies that each unit operates properly under the set conditions and expected outdoor air temperature when the system is actually assembled.

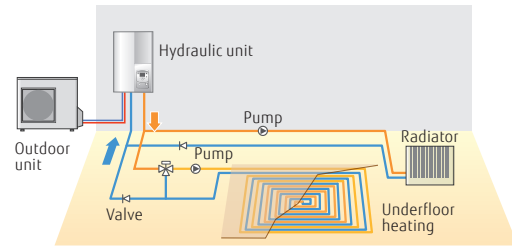

The outdoor temperatures can be simulated in the range of -50°C to +50°C.

Concrete floor drying

Allows the concrete surrounding the hot-water pipes to dry more quickly, shortening the construction period for underfloor heating installations.

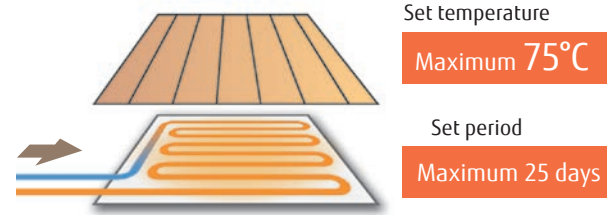

Controller with a large liquid crystal display and buttons for easy function setting

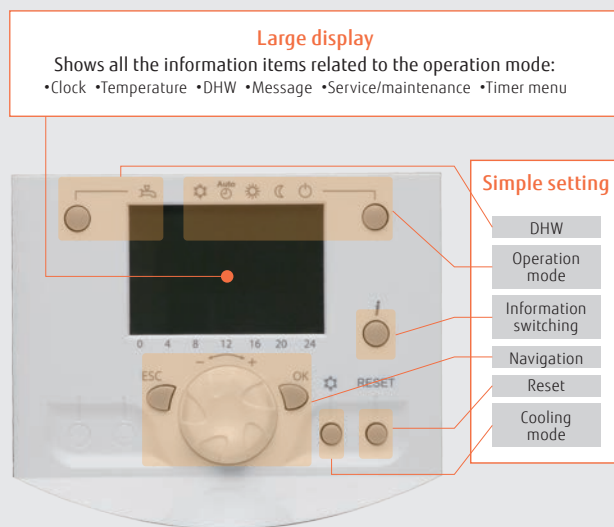

Main operation flow and settings for installers and end users

	Flow Chart	Example Item
Installers	1 Install Setting	Pump speed setting, Configuration, Heating curve setting, Heat pump shut off
	2 Option Setting	Cooling kit, DHW kit, Boiler kit
	3 Convenient Function	Automatic heating curve setting, Underfloor controlled driving, Outdoor temperature adjustment, Maintenance period setting
	4 Workout Setting	Outdoor temperature simulator
	5 Confirmation	Checking operation (Heating and cooling, DHW, option)
End users	6 User Setting	Date and time, Time program, Operation temperature setting

Easy Installation & Maintenance

- All hydraulic safety and control components are built in with no additional selection required.
- Lifting bars for installation free of difficulty or risk
- Easy access for maintenance
- Refrigerant pump down operation

Maintenance Support

Diagnostics functions for troubleshooting

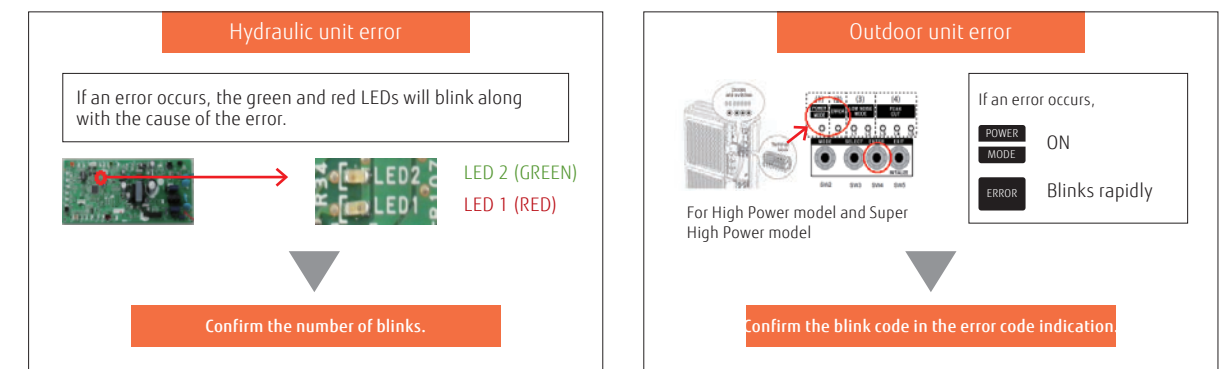
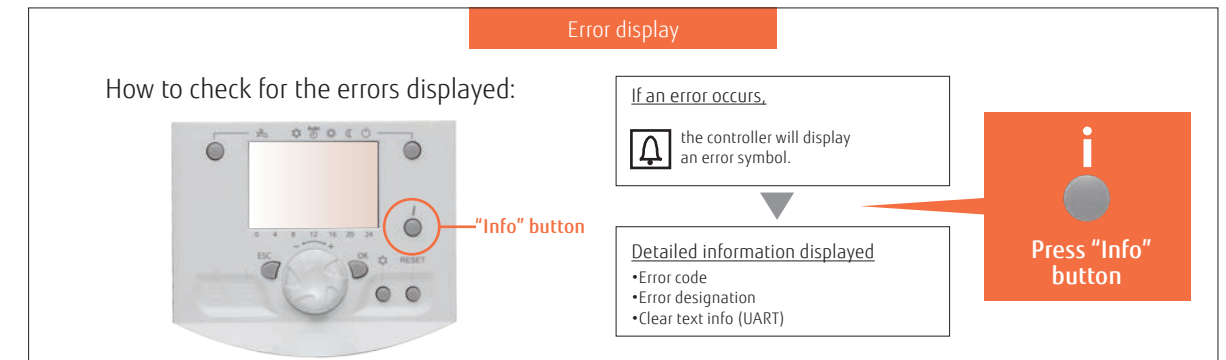

Check the error code table

Installation requirements

Installation of equipment & electrical wiring

Split type Hydraulic unit

- The Hydraulic unit is hung on the wall.
- Weight ≤ 88 kg (including water)
- Space for maintenance needs to be taken into consideration.

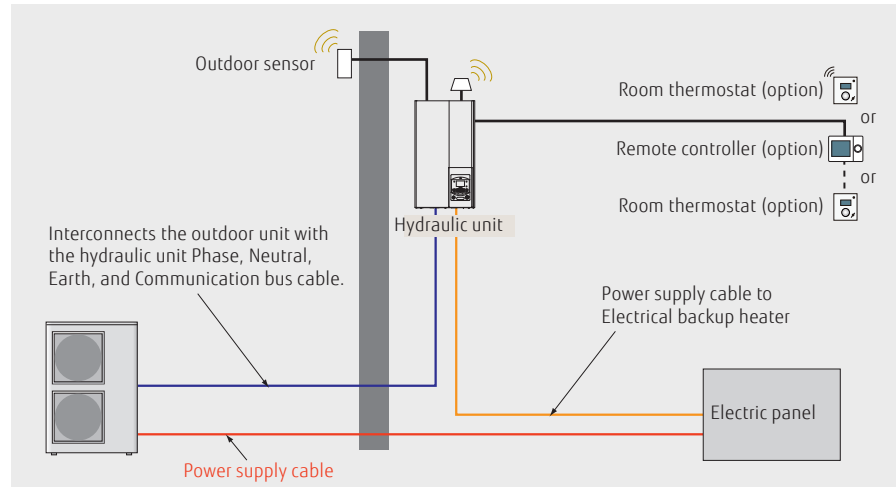
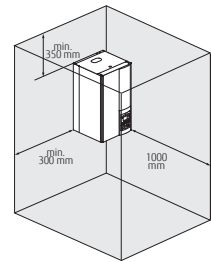

Split DHW Integrated Type Hydraulic Unit

- Floor standing
- Weight ≤ 393 kg (including water)
- Space for maintenance needs to be taken into consideration.

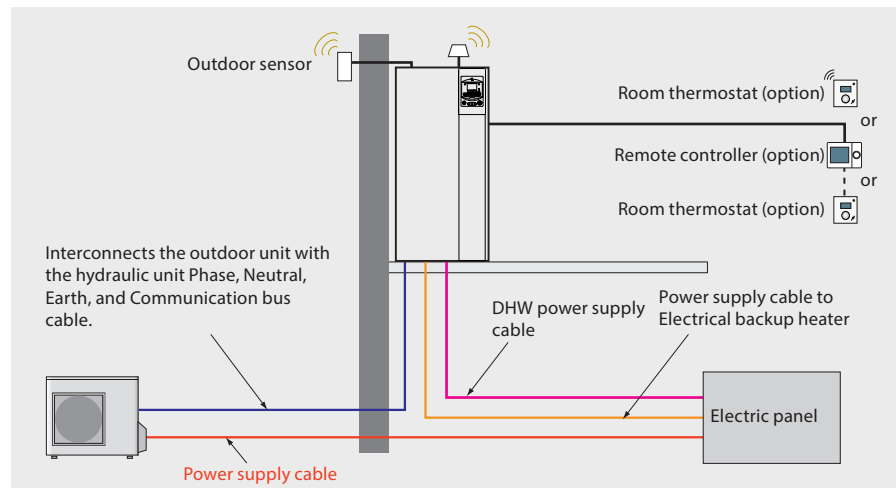
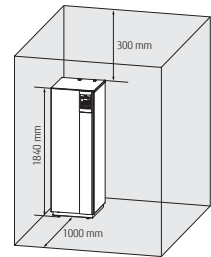

Piping and Wiring split type

Series	Capacity range (kW)	Pipe diameter (Liquid/Gas) (mm)	H1 (m)	H2 (m)	L (m)
R32 Comfort	5	6.35/12.70	+20	-20	3-30
	6				
	8				
	10				
High Power	11	9.52/15.88	+15	-15	5-20
	14				
	16				
Super High Power	16	9.52/15.88	+15	-25	5-30

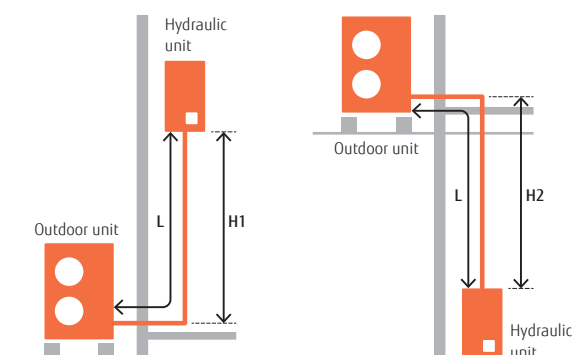

AIR TO WATER Optional Parts

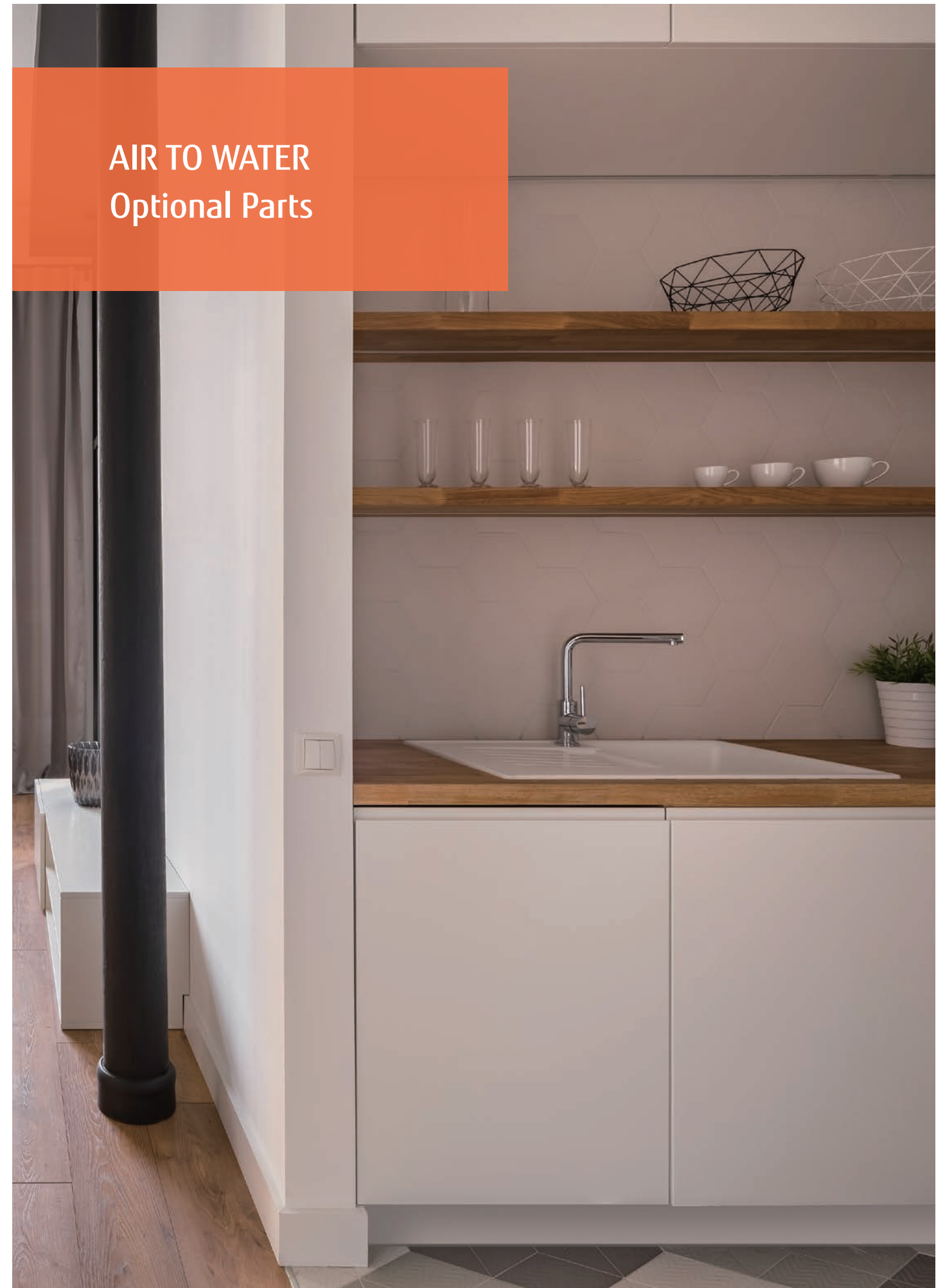

Optional Parts

Product Name	Model Name	Split Type										Split DHW Integrated Type											
		Super High Power		High Power				R32 Comfort				Super High Power		High Power				R32 Comfort					
		10	16	10	14	11	14	16	5	6	8	10	10	16	10	14	11	14	16	5	6	8	10
		10	16	11	14	11	14	16	5	6	8	10	10	16	11	14	11	14	16	5	6	8	10
Second circuit Kit	UTW-KZSXE*6	-	•	•	•	•	•	•	•	•	•	-	-	-	-	-	-	-	-	-	-	-	-
	UTW-KZDXE*6	-	-	-	-	-	-	-	-	-	-	-	•	•	•	•	•	•	•	•	•	•	•
	UTW-KZSXJ	•	-	-	-	-	-	-	-	-	-	-	-	-	-	-	-	-	-	-	-	-	-
	UTW-KZDXJ	-	-	-	-	-	-	-	-	-	-	•	-	-	-	-	-	-	-	-	-	-	-
Boiler connection kit	UTW-KBSXD	-	•	•	•	•	•	•	•	•	•	-	-	-	-	-	-	-	-	-	-	-	-
	UTW-KBDXD	-	-	-	-	-	-	-	-	-	-	•	•	•	•	•	•	•	•	•	•	•	•
Balancing vessel	UTW-KBSXJ	•	-	-	-	-	-	-	-	-	-	•	-	-	-	-	-	-	-	-	-	-	-
	UTW-TEVXA	•	•	•	•	•	•	•	•	•	•	•	•	•	•	•	•	•	•	•	•	•	•
DHW kit	UTW-KDWD (External)	•	•	•	•	•	•	•	•	•	•	_*1	_*1	_*1	_*1	_*1	_*1	_*1	_*1	_*1	_*1	_*1	_*1
DHW tank	200 Liters 300 Liters	•	•	•	•	•	•	•	•	•	•	_*1	_*1	_*1	_*1	_*1	_*1	_*1	_*1	_*1	_*1	_*1	_*1
	200 Liters 300 Liters	•	•	•	•	•	•	•	•	•	•	_*1	_*1	_*1	_*1	_*1	_*1	_*1	_*1	_*1	_*1	_*1	_*1
DHW expansion kit	UTW-KDEXE	-	-	-	-	-	-	-	-	-	-	•	•	•	•	•	-	-	-	-	-	-	-
	UTW-KDEXL	-	-	-	-	-	-	-	-	-	-	-	-	-	-	-	•	•	•	•	•	•	•
Circulating pump	UTW-PHFXG	•	•	•	•	•	•	-	-	-	-	•	•	•	•	•	-	-	-	-	-	-	-
Cooling kit	UTW-KCLXD	•	•	•	•	•	•	•	•	•	•	•	•	•	•	-	-	-	-	-	-	-	-
	UTW-KCLXL	-	-	-	-	-	-	-	-	-	-	-	-	-	-	•	•	•	•	•	•	•	•
Regulation extension kit	UTW-KREXD	•	•	•	•	•	•	•	•	•	•	•	•	•	•	•	•	•	•	•	•	•	•
Drain pan	UTW-KDPXB	-	-	-	-	-	-	•	•	•	•	-	-	-	-	-	•	•	•	•	•	•	•
Cascade master kit (incl. LPB clip)	UTW-KCMXE	-	•	•	•	•	•	-	-	-	-	-	-	-	-	-	-	-	-	-	-	-	-
Cascade slave kit (incl. LPB clip)	UTW-KCSXE	-	•	•	•	•	•	-	-	-	-	-	-	-	-	-	-	-	-	-	-	-	-

Product Name	Model Name	Split Type										Split DHW Integrated Type											
		Super High Power		High Power				R32 Comfort				Super High Power		High Power				R32 Comfort					
		10	16	10	14	11	14	16	5	6	8	10	10	16	10	14	11	14	16	5	6	8	10
		10	16	11	14	11	14	16	5	6	8	10	10	16	11	14	11	14	16	5	6	8	10
HMI kit	UTW-KHMXE*2	•	•	•	•	•	•	•	•	•	•	•	•	•	•	•	•	•	•	•	•	•	•
Remote controller	UTW-C74TXF*2	•	•	•	•	•	•	•	•	•	•	•	•	•	•	•	•	•	•	•	•	•	•
	UTW-C74HXF*2	•	•	•	•	•	•	•	•	•	•	•	•	•	•	•	•	•	•	•	•	•	•
Room thermostat	Wired	•	•	•	•	•	•	•	•	•	•	•	•	•	•	•	•	•	•	•	•	•	•
	Wireless	•	•	•	•	•	•	•	•	•	•	•	•	•	•	•	•	•	•	•	•	•	•
Outdoor sensor transmitter	UTW-MOSXD	•	•	•	•	•	•	•	•	•	•	•	•	•	•	•	•	•	•	•	•	•	•
RF modules for BSB-Port	UTW-MRCXD	•	•	•	•	•	•	•	•	•	•	•	•	•	•	•	•	•	•	•	•	•	•
Web server*7	UTW-KW1XD	•	•	•	•	•	•	•	•	•	•	•	•	•	•	•	•	•	•	•	•	•	•
	UTW-KW4XD	-	•	•	•	•	•	-	-	-	-	-	-	-	-	-	-	-	-	-	-	-	-
LPB clip	UTW-KL1XD	•	•	•	•	•	•	•	•	•	•	•	•	•	•	•	•	•	•	•	•	•	•
MODBUS® clip	UTW-KMBXJ	-	•*5	•*5	•*5	•*5	•*5	-	-	-	-	-	-	-	•*5	•*5	•*5	•*5	•*5	-	-	-	-
Service tool (incl. OCI700 Adapter)	UTW-KSTXD	•*3	•*3	•*3	•*3	•*3	•*3	•*3	•*3	•*3	•*3	•*3	•*3	•*3	•*3	•*3	•*3	•*3	•*3	•*3	•*3	•*3	•*3
Service tool software	UTW-KPSXD	•*4	•*4	•*4	•*4	•*4	•*4	•*4	•*4	•*4	•*4	•*4	•*4	•*4	•*4	•*4	•*4	•*4	•*4	•*4	•*4	•*4	•*4
External connect kit	UTY-XWZXZ2	-	•	•	•	•	•	-	-	-	-	-	-	-	-	-	-	-	-	-	-	-	-
	UTY-XWZXZ3	•	-	-	-	-	-	-	-	-	-	•	•	•	•	•	•	•	•	•	•	•	•
Back-up Heater	UTW-HS6XG	-	•	•	-	-	-	-	-	-	-	-	-	-	-	-	-	-	-	-	-	-	-
	UTW-HT9XG	-	-	-	•	•	•	-	-	-	-	-	-	-	-	-	-	-	-	-	-	-	-
Electrical backup heater relay	UTW-KBHXL	-	-	-	-	-	-	•	•	•	•	-	-	-	-	-	-	-	-	•	•	•	•

•: Available -: Not Available

*1: Split DHW integrated type supplies DHW without the DHW kit and DHW tank.
 *2: Includes 19 languages with no need to prepare an RC for Eastern Europe separately.
 C74TXF has a built-in room temperature sensor.
 C74HXF has a built-in room temperature and humidity sensor.
 *3: UTW-KL1XD is required for the connection.
 *4: UTW-KW1XD or UTW-KW4XD is required for the connection.
 *5: Additional Spare parts 9708302034 (Analogue interface PCB) and 109696 (connection wire) are required.
 *6: The UTW-KREXD (Regulation extension kit) is not included but is required for connection.
 *7: The connection of UTW-KW4XD for simultaneous control of multiple ATW units is only possible for cascade systems.

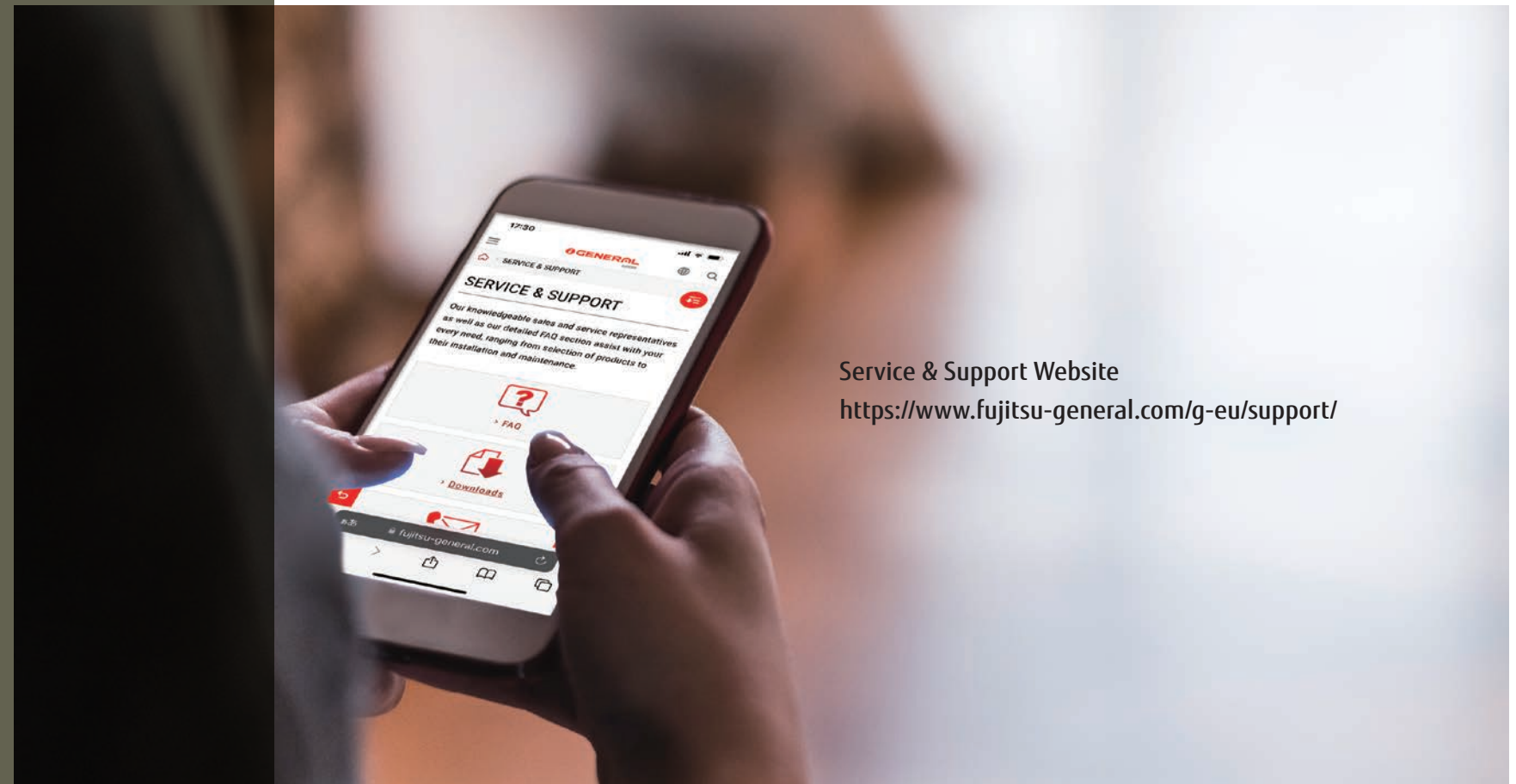

Service & Support Website
<https://www.fujitsu-general.com/g-eu/support/>

SUPPORT

- Sp-002 AIRSTAGE Support
- Sp-004 HVAC system design Support Tool
- Sp-006 WATERSTAGE Support Tool
- Sp-008 Quick Service & Maintenance
- Sp-010 Service Tool
- Sp-011 Web Monitoring Tool

Our knowledgeable sales and service representatives assist you, from product selection to installation and maintenance.

Category	Information material										Tool							
	Product sales training material	Product technical training material	Product news	Brochures	Promotional movies	Operation manuals	Design & Technical manuals	Certification data	2D CAD data	3D CAD (Revit) data	Installation manuals	Service manual	WATERSTAGE Package label creator	Design simulator (Room air conditioner, Packaged air conditioner, and VRF)	WATERSTAGE proposer	CFD simulation	Service tool and Web monitoring tool	Mobile technician
Product training	●	●																
Product information seeking			●	●	●	●	●											
Technical information seeking						●	●					●						
Model selection						●							●	●				
Design						●		●	●									
Verification																●		
Installation						●				●								
After-sales service											●						●	●

AIRSTAGE Support

Fujitsu General provides engineers and consultants with a wide range of product and technical information. In addition, we conduct research on new products and support design activities. We provide a wide range of support services from design to installation to maintain high quality.

Technical information

We provide equipment selection software that facilitates the design of air conditioning systems by providing performance data for the units and estimation for model selection.

Features

- Design & Technical manuals
- Model selection & estimation
- Certification data
- 2D/3D CAD data

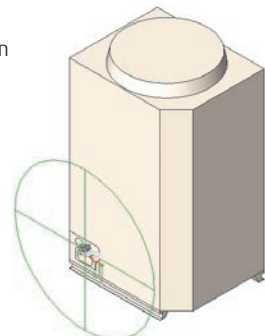

2D/3D CAD data

Product information

Information on new models is provided in the form of documents and movies in a timely manner for release, readily downloadable from the private section of our website. Contact your Fujitsu General representative for access information.

Features

- Product news
- Brochures & manuals
- Promotional movies

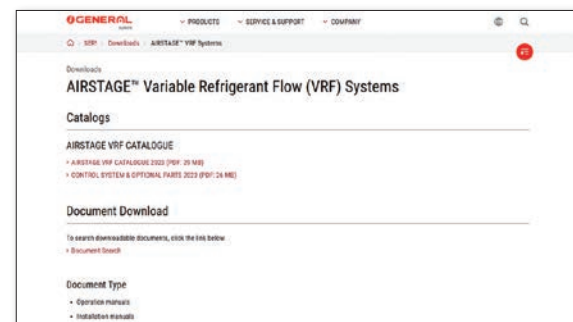

<https://www.fujitsu-general.com/g-eu/support/downloads/vrf/>



Training facilities

Technical support

Technical support is offered at every stage, from design through to installation, to assist in optimizing air conditioning solutions.

Features

- CFD simulation
- Guidelines
- Commissioning support

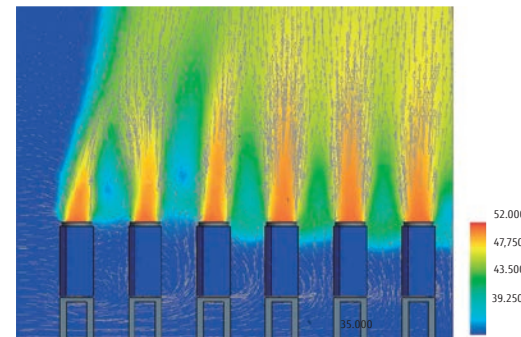

CFD simulation



Commissioning support



Fujitsu General regularly provides professional product, technical and service training at its training facilities worldwide. These research facilities also support the development of human resources with advanced technical skills.

Features

- Designing VRF systems
- On-site training for control systems

- 1 Head office training center in Japan
- 2 Training center in China
- 3 Asia training center in Singapore
- 4 Europe training center in the United Kingdom
- 5 Europe training center in Germany
- 6 America training center in the United States
- 7 Middle East training center in the UAE
- 8 Oceania training center in Australia

HVAC system design Support tool

Put the charts and pens away and design your projects on a computer using the Design simulator. Everything from selecting indoor and outdoor units, allocating controls and optional parts through to designing the piping and wiring systems is made easier using the program's built-in features. Once the project design is complete, the Export function makes it easy to generate material lists, product specifications, and refrigerant calculations, and more. You can also export in Word, Excel, and Acrobat formats, as well as group CAD data related to your project.



Design simulator

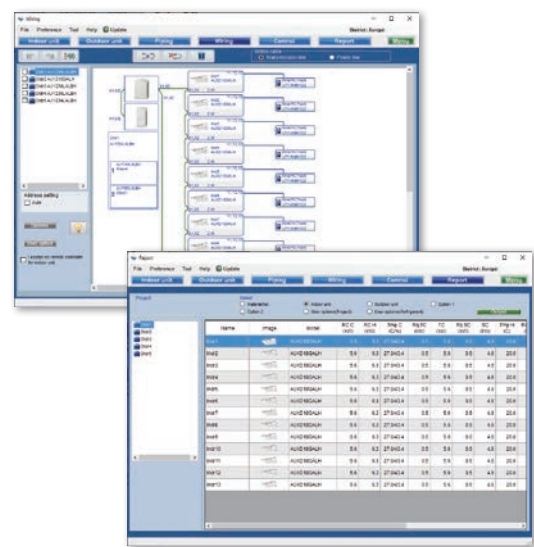

Outputs in the format that matches the application

You can export your project information in a number of industry standard file formats.

- Word format (rtf) (doc)
- Excel format (csv)
- Acrobat format (pdf)
- 2D CAD data (DXF)

Automatically create model selection information

- The required performance, type, and temperature conditions for each indoor unit are entered and then dragged and dropped onto the outdoor unit to automatically set each unit.
- Creates piping and wiring diagrams automatically to facilitate branching, grouping, and option settings.
- The additional refrigerant charging is automatically calculated when the pipe length is entered.
- Easy configuration of remote controller groups, central controller, and converters.
- The equipment list including the equipment information is created automatically.

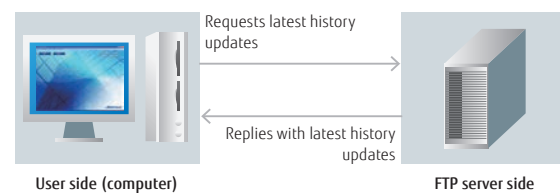

Update your Design simulator

The database can be updated easily online with the AutoUpdate function using FTP.

BIM Building information modeling



BIM files of Fujitsu General's products are available on BIMobject®

Fujitsu General is releasing BIM files of our products on the BIMobject® website BIMobject.com.

Outline of BIMobject®

BIMobject® is a game changer for the construction industry, offering development, maintenance, and syndication of objects on the world's largest BIM platform.

About BIM files

- BIM files can be viewed in Autodesk Revit® 2018 version or later.
- In each BIM file, the location of the connectors for the refrigerant and drain pipe is different.
- Each BIM file includes several family types.
- A catalog and specification sheet is available in Revit file format for each product.

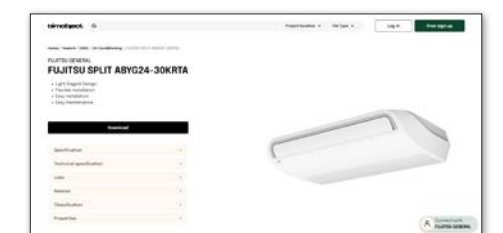
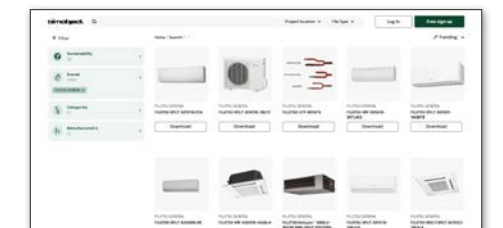
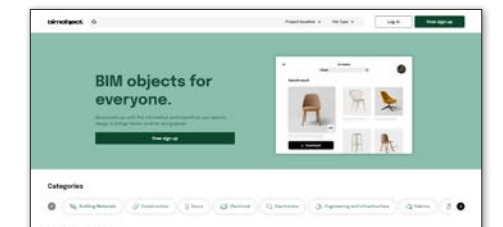

R RFA (Revit data)
A data format available for BIM-designed projects

A DWG
a standard data format used for Autodesk products

Data content

- Shape (Size)
- Drain direction
- Pipe direction
- Power supply location
- It contains information about the above specifications.

Type catalog with product specifications



DXF

Intermediate data commonly available in CAD products

Data content

- Shape (Size)

*To learn more about how to use BIM files, refer to the instructional video on each product page. youtu.be/wfL-hwFQ7dM

WATERSTAGE Support tool

Fujitsu General's software for WATERSTAGE automatically creates a combination of WATERSTAGE equipment by simply providing a few parameters. Supports multiple languages with an automatic update function.

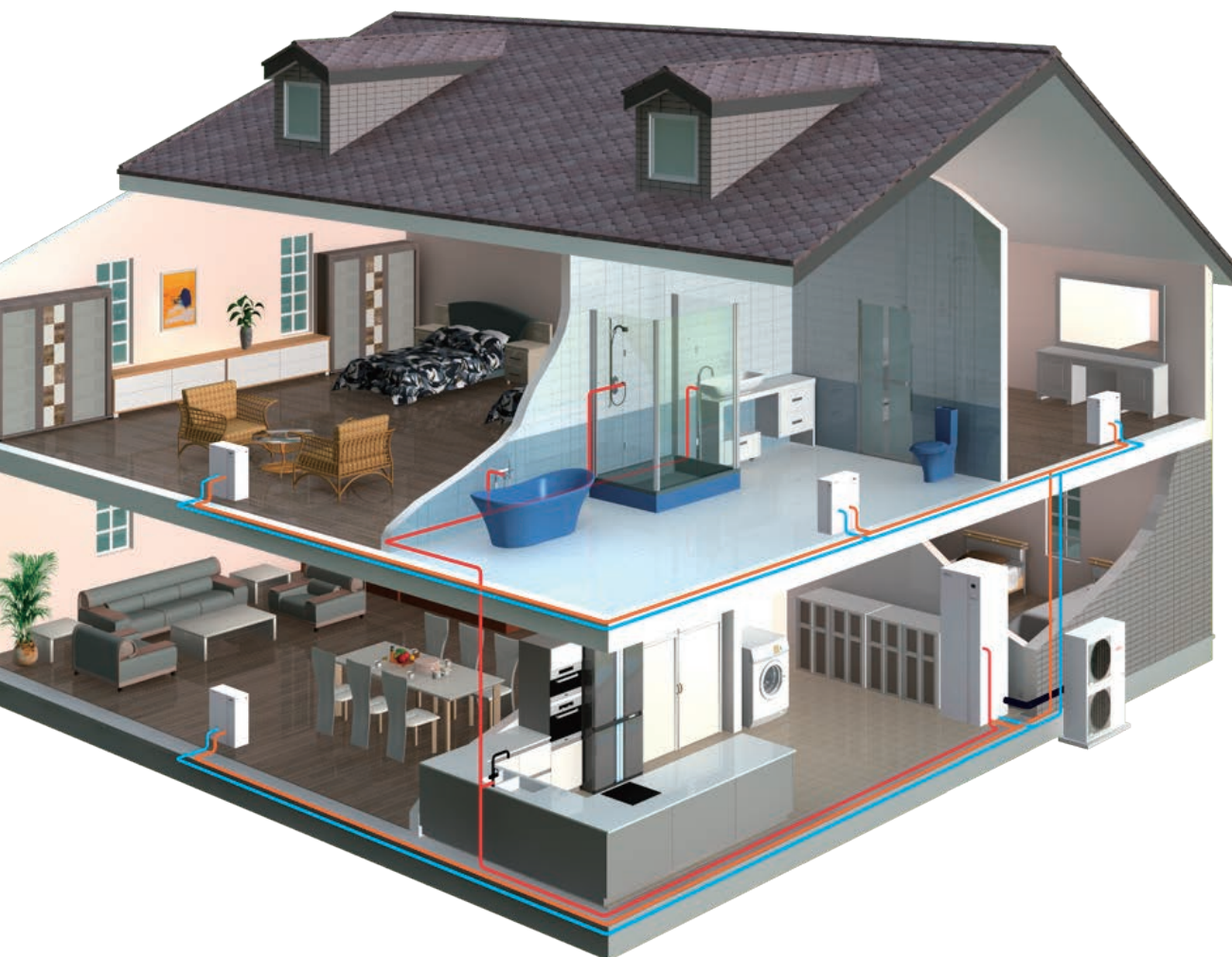
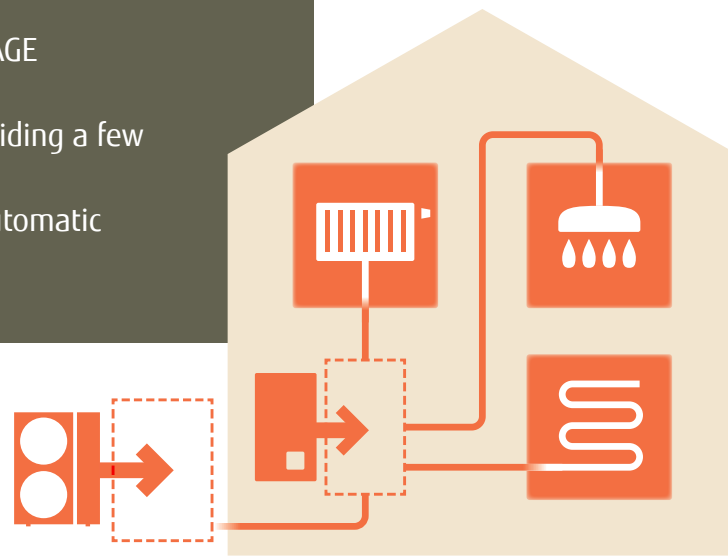

WATERSTAGE proposer

Selecting models with detailed technical information

- Simply enter the region where the equipment will be installed, the required heating capacity, the method of heating and other factors, and the software will select the appropriate equipment automatically.

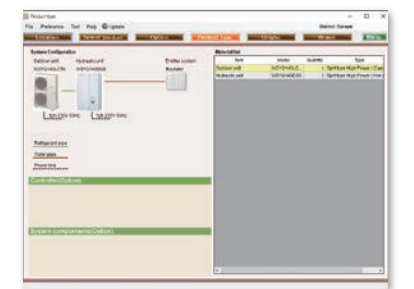

The images of the optional items will help you configure your system correctly. If more than one WATERSTAGE equipment is required, all relevant option items will be selected automatically.

The selected unit can be modified after reviewing the overall system configuration. The images and the list of devices are displayed at the same time, helping to avoid mistakes in device selection.

WATERSTAGE Package label creator

Download Energy labels and Fiches from our website

ErP documents such as Energy labels, Product fiches, Package labels, Package lists, Information sheets, and EC Declarations can be searched for and downloaded from our website.

We will also provide an online service in the future so that installers can easily create various package labels and package fiches for different models.

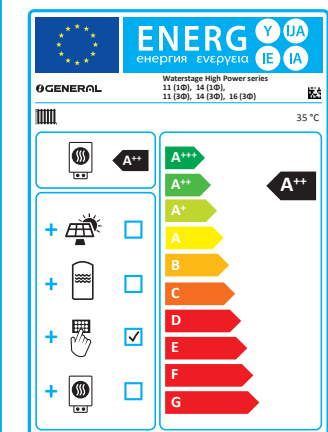
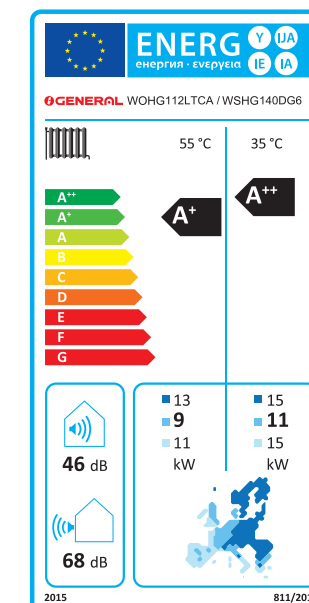

Quick service & maintenance

In the unlikely event that a problem should occur with the unit or system, a wide variety of support tools are available to assist with prompt service and maintenance anytime, anywhere, including error code displays on the product, service tools to check the detailed status of the entire system, and remote monitoring tools using the internet.



Easy maintenance & monitoring

Designed for easy maintenance

The operating status of the air conditioner and detailed trouble conditions are displayed on the 7-segment indicator lamp on the outdoor unit printed circuit board (PCB) and on the screen of the remote controller. Check the status of the unit quickly for a prompt response.

- Display the operation mode at the time.
- Discharge temperature and pressure
- Compressor operation status
- "Address/Type/Number" of the outdoor unit
- Error code

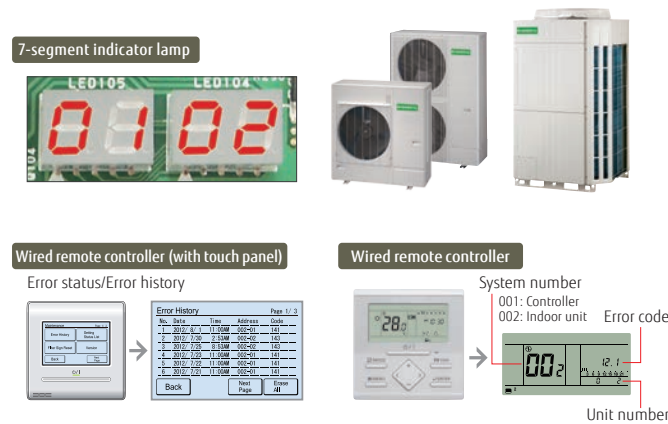

Error diagnosis by Service tool

Connect Service tool to check the status details of units, from single split to VRF, on a computer screen. Check the errors quickly for prompt countermeasures.

- Operating status/control
- Monitoring operating conditions
- Monitoring sensor data
- Indicating trend graphs
- Error history
- Indicating refrigerant circuit diagrams (for VRF)

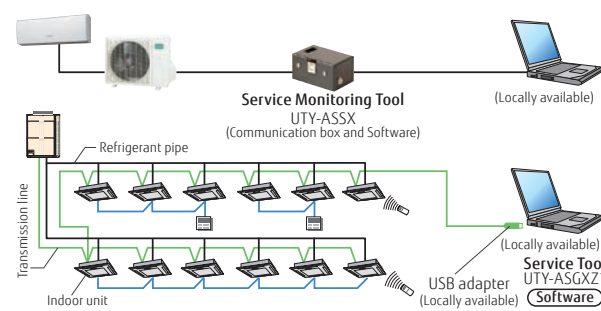

Remote monitoring

VRF system operating status and trouble status details can be monitored remotely at any time via the internet. Prompt coordination is available with service personnel.

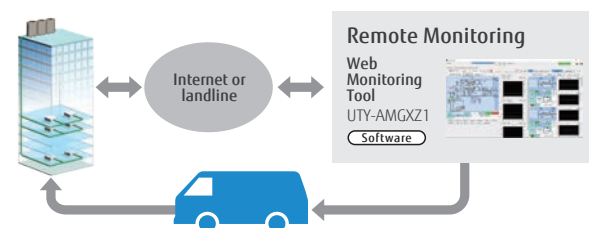

Mobile troubleshooting App for iOS and Android™ devices

We will release an App for troubleshooting tools for iPhone, iPod touch and other Apple devices, and Android products for Fujitsu General air conditioners (Room air conditioner/ Packaged air conditioners VRF and ATW, "AIRSTAGE Mobile", and R32 calculation of allowable refrigerant capacity)

Use Error Code Check, Troubleshooting, and Sensor Check to understand the status of your air conditioner.

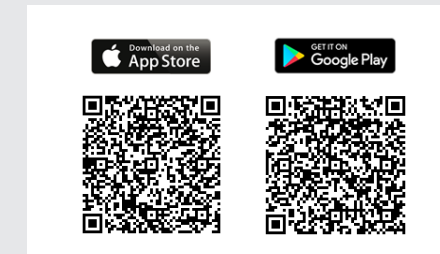

Service monitoring tool for Single split, Multi-split & Air to water



- A quick overview of the temperature sensor readings and the electronic expansion valves (EEVs), fans, compressors and other control components
- It is not always easy to read the temperature sensor and know the status of the control components. So let the Service monitoring tool judge them.
- Visualizes protected operations
- Troubleshoots intermittent problems effectively
- Provides proof of normal operation to customers during periodical maintenance

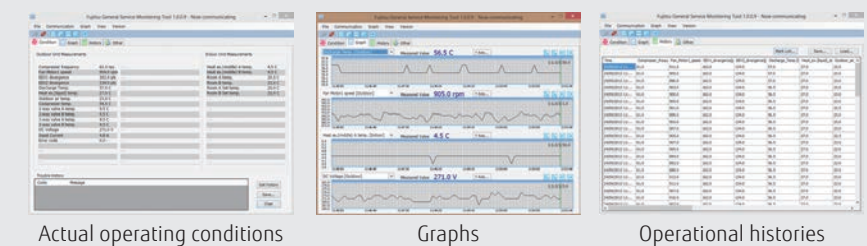

	UTY-ASSX
Dimensions (H × W × D) (mm)	60 × 160 × 160
Weight (g)	500

Service tool

UTY-ASGXZ1

Extensive monitoring and analysis functions that make installation and maintenance easier

- The operation status of the system can be monitored and analyzed to detect any malfunctions.
- Data on the operation status of the system can be stored on a computer to allow for remote access.
- Up to 400 indoor units in a single VRF network system can be controlled and monitored for a large building or hotel.
- This software can be connected to any point of transmission line with a USB adapter (locally available).

* Saved data can be displayed offline. Note that the data saved by the following software applications cannot be displayed.

- UTR-YSTB/UTR-YSTC (Service tool)
- UTR-YMSA (Web monitoring tool)

Automatic operation check for refrigeration cycles

Once installed, the Service tool automatically checks for refrigeration cycles. The self-diagnosis function determines whether each sensor value is normal, which reduces the need for manual checks. The result of a diagnosis can be provided in a report.

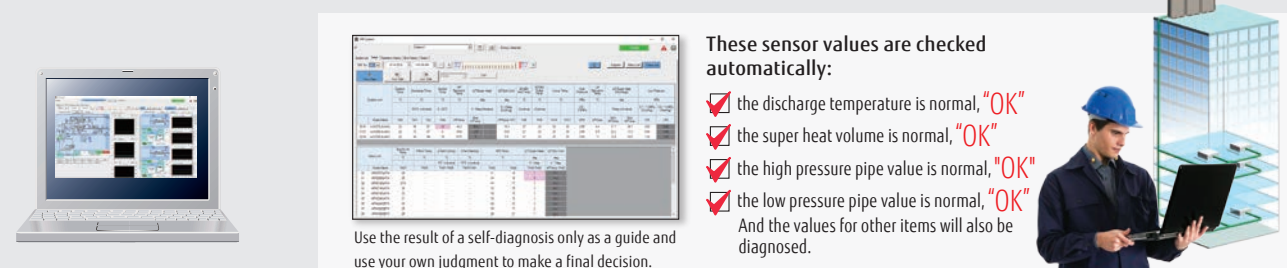

Use the result of a self-diagnosis only as a guide and use your own judgment to make a final decision.

These sensor values are checked automatically:

- ✓ the discharge temperature is normal, "OK"
- ✓ the super heat volume is normal, "OK"
- ✓ the high pressure pipe value is normal, "OK"
- ✓ the low pressure pipe value is normal, "OK"

And the values for other items will also be diagnosed.

Remote technical support and maintenance

On-site check screen can be shared between on-site staff and a service technician in a remote location. When a service technician visits the site for troubleshooting, the system's operation status can be shared in real time with a remote service center for assistance. On-site staff can have an online chat with a remote service center to get further assistance.

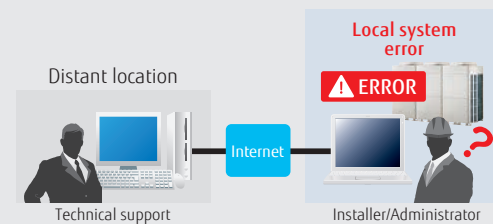

Trend charts

Previous-generation application could display only 3 sets of data from sensors. However, the current generation of the service tool displays multiple charts simultaneously so that refrigeration cycles can be monitored and checked in greater detail.



Computer requirements

UTY-ASGXZ1	
Operating system	• Microsoft® Windows® 7 Professional (32-bit or 64-bit) SP1 • Microsoft® Windows® 8.1 Pro (32-bit or 64-bit) • Microsoft® Windows® 10 Pro (32-bit or 64-bit)
CPU	1 GHz or higher
Memory	• 1 GB or more (for Windows® 7 [32-bit], Windows® 8.1 [32-bit], and Windows® 10 [32-bit]) • 2 GB or more (for Windows® 7 [64-bit], Windows® 8.1 [64-bit], and Windows® 10 [64-bit])
HDD	40 GB or more of free space
Screen resolution	1366 × 768 pixels or higher
Interface	• USB port for U10 USB Network interface and software protection key
Software	Internet Explorer® 11 or Microsoft Edge

Packing list

Name	Quantity	Application
White-USB-key (Software protection key)	1	Software protection key to be connected to a USB port on a Service tool-installed computer. This software runs only on a computer with WibuKey.

*Computer requirements
*Echelon® U10 USB Network Interface – TP/FT-10 Channel (Model name: 75010R) (Required for each VRF Network)

Web monitoring tool

UTY-AMGXZ1

Features

- Troubleshooting is performed by monitoring each air conditioning unit remotely during a periodical system check.
- An error notification is automatically transmitted to several locations via the internet*1.
- Requires either a dedicated internet connection or landline to operate.
- The occurrence of an error can be confirmed through an error alert and equipment status information obtained from a remote location.
- Monitoring data can be downloaded in a remote location. These data can be accessed and displayed even when the service tool is in offline mode.
- Can be viewed on the monitoring computer's Web browser without installing any special software.

*1: Internet e-mail access required.

Web Monitoring System

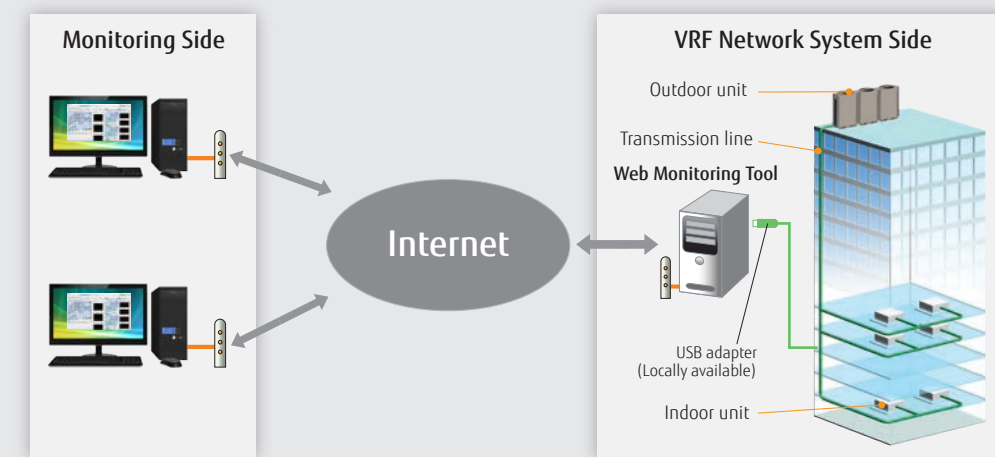

Supporting up to 4 VRF network systems

Up to 4 USB adapters can be connected to a computer, enabling the monitoring of up to 1,600 indoor units.

Suitable for use in a large building or hotel.

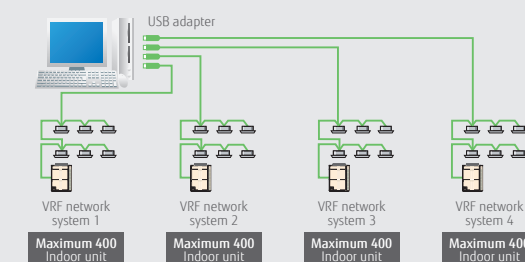

Computer requirements

UTY-AMGXZ1	
Operating system	• Microsoft® Windows® 7 Professional (32-bit or 64-bit) SP1 • Microsoft® Windows® 8.1 Pro (32-bit or 64-bit) • Microsoft® Windows® 10 Pro (32-bit or 64-bit)
CPU	1 GHz or higher
Memory	• 1 GB or more (for Windows® 7 [32-bit], Windows® 8.1 [32-bit], and Windows® 10 [32-bit]) • 2 GB or more (for Windows® 7 [64-bit], Windows® 8.1 [64-bit], and Windows® 10 [64-bit])
HDD	40 GB or more of free space
Screen resolution	1366 × 768 pixels or higher
Interface	• USB ports (one for U10 USB Network interface and up to 4 ports for software protection keys) • Interface for remote connection: - Landline: Modem is required. - Internet using LAN: Ethernet port is required.
Software	Internet Explorer® 11 or Microsoft Edge

Packing list

Name	Quantity	Application
White-USB-key (Software protection key)	1	Software protection key to be connected to a USB port on a Service tool-installed computer. This software runs only on a computer with WibuKey.

*Computer requirements
*Echelon® U10 USB Network Interface – TP/FT-10 Channel (Model name: 75010R) (Required for each VRF Network)