

Residential AIR TO WATER

- W-002 AIR TO WATER Overview
- W-004 Things We can Contribute to
- W-006 Energy Efficiency Standards
- W-008 AIR TO WATER Series Overview
- W-010 AIR TO WATER Lineup
- W-012 Monobloc Type
 - Comfort series
- W-022 Split Type
 - Comfort series
 - High Power series
 - Super High Power series
- W-038 Indoor Unit
 - Type-A, Type-B
- W-042 Optional Parts & Control Overview
- W-044 Optional Parts List for Type-A
- W-050 Control Overview
- W-052 Optional Parts Overview
- W-054 Optional Parts List for Type-B



AIR TO WATER
Residential

AIR TO WATER Overview

Solutions That Meet a Variety of Needs

Water heated by Air to Water, which uses clean energy, can provide a steady supply of comfortable water throughout the home for heating and hot water applications.



Air-to-Water Heat Pump

Outdoor unit

The unit is used to extract heat from the environment, making use of renewable energy resources from the sun and the outside air.

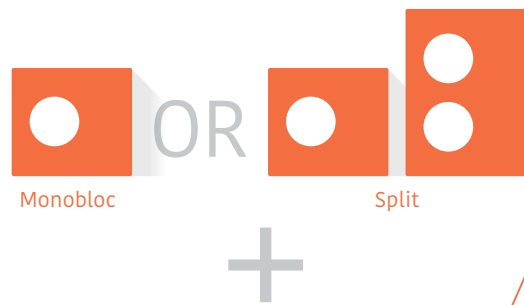

Indoor unit control box*

If you want to update your system by reusing your existing pump and buffer tank, etc., you can do so by installing only the control box.

OR



Indoor unit Wall-mounted

Stands for preparation of heating water for under floor heating and radiators. It can optionally operate with domestic hot water tank.

OR



Indoor unit Domestic Hot Water integrated

Can be used with a variety of heating systems, including under floor heating and radiators. Space saving heating and DHW supply in a single indoor unit.

*The control box can only be selected for Monobloc outdoor unit.

Ecological Consideration in Your Home

Heat pump system framework

Heat is absorbed from the atmosphere by expanding the refrigerant. Higher-temperature heat is generated by compressing the refrigerant, and the indoor unit transfers that heat to the water.

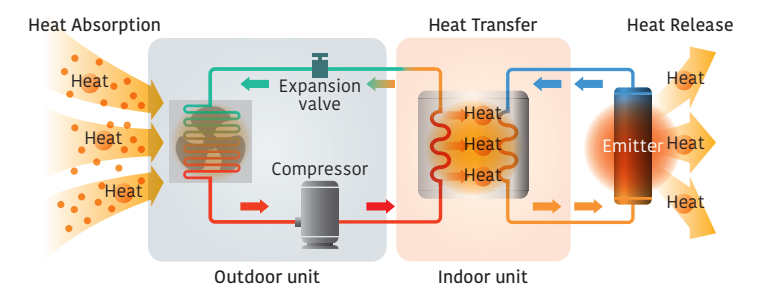

*Split products are listed as examples.

Things We can Contribute to



Our Goal

Decarbonisation

European Commission is committed to decarbonisation and has a national target of “Net Zero” carbon emissions by 2050.

We need to reduce carbon emissions with green technology products and increase carbon absorption by working to extend nature.

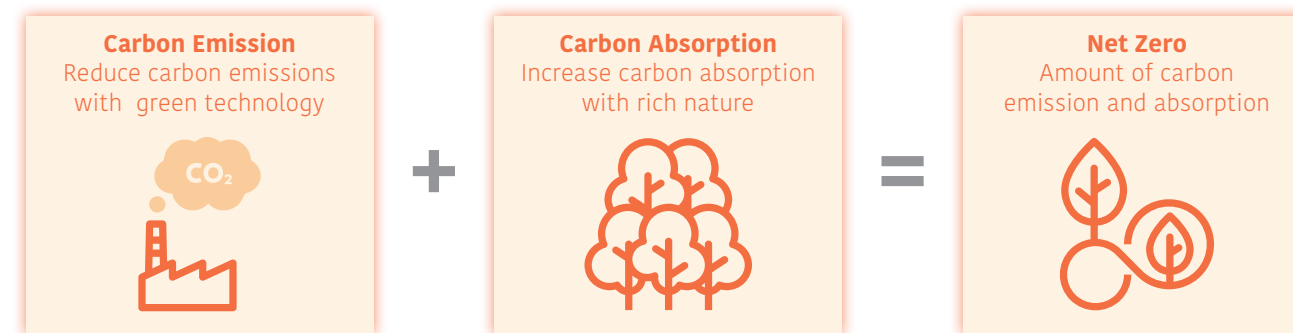

Fujitsu General's ATW system will provide the best solutions that are friendly to the environment and people with products conscious of decarbonisation.

What is a heat pump?

A heat pump extracts heat energy from the atmosphere. It requires only 1 kW of electricity to generate 3 to 5 kW of thermal energy.

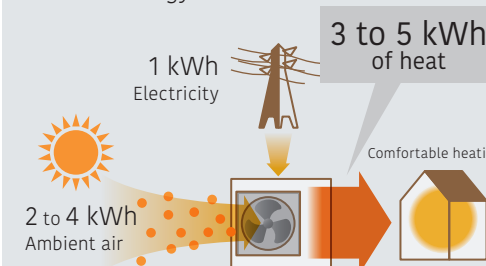

Primary energy usage reduced substantially

Proportion of primary energy converted into heating energy is 100%

Primary Energy Consumption*

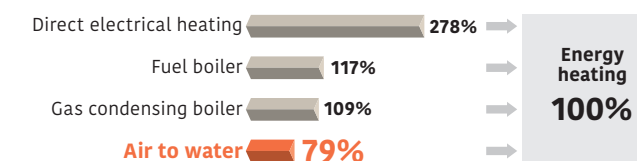

* The amount of electricity loss varies according to the power plant. Typical energy efficiency of a power plant: 36%

The Choice of ATW

Optimized refrigerant cycle operation

Split Type

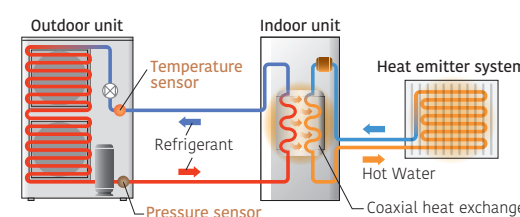

Monobloc Type

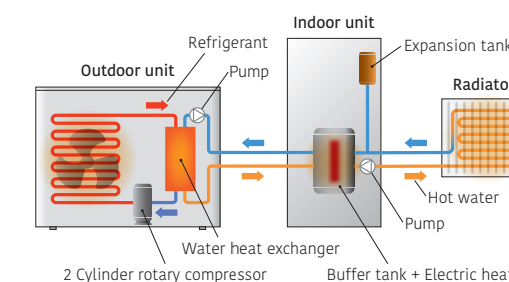

Energy Efficiency Standards Product Labels

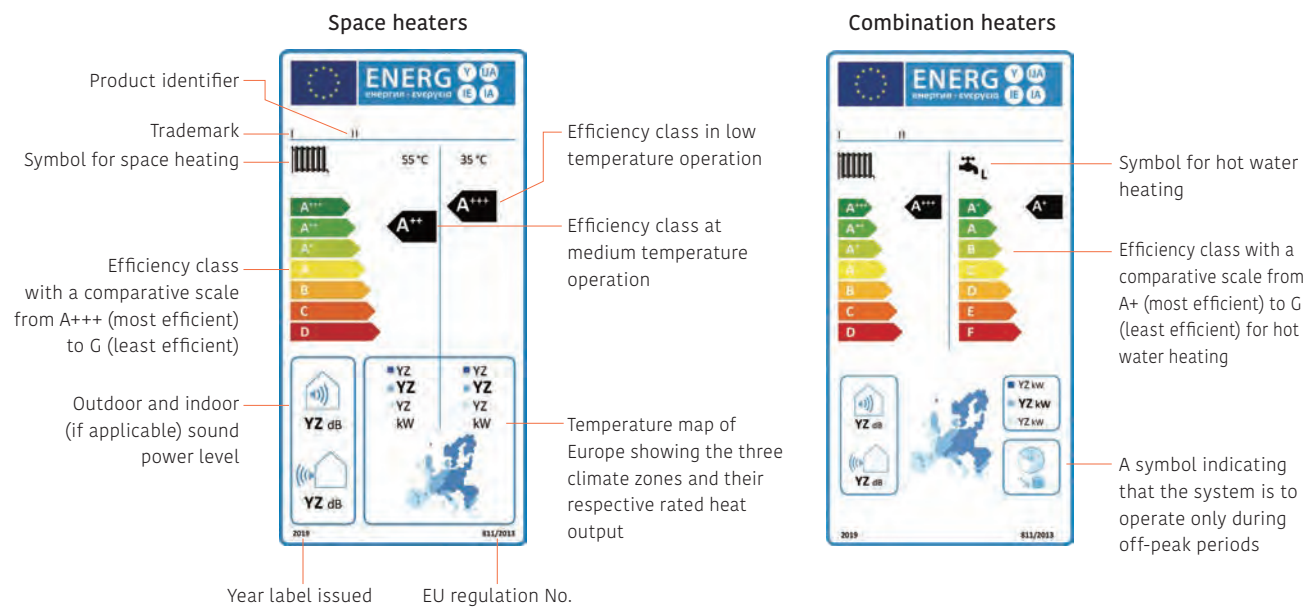

Due to restrictions on the use of fossil fuels in Europe and the F-Gas regulations, the use of environmentally friendly heating equipment is required not only for new buildings but also for renovated properties. Let's consider installing high energy efficiency products that will be essential for future living environments.

Heating Equipment



The Ecodesign Directive Lot 1 Regulation 813/2013

The Ecodesign directive defines a regulatory framework for improving the environmental performance of energy-related products (ErP) through design. Since September 26, 2015, the Ecodesign Directive has applied to space heaters, including heat pumps and fossil fuel fired boilers, combination heaters for space and hot water heating, water heaters, and water storage tanks. All of these products must meet minimum requirements for energy efficiency*1 and maximum sound power level. The minimum energy efficiency class were raised on September 26, 2017, and the maximum sound levels were lowered on September 26, 2018.

*1: Energy efficiency is expressed in terms of seasonal space heating efficiencies (η_s). The value is based upon the Seasonal Coefficient of Performance (SCOP).

The Energy Labelling Directive (EU) No. 811/2013

Energy label is intended to enable consumers to make direct comparisons of energy use and product features. All labels should indicate the product identifier, efficiency class, sound power level, and heat output. Heat generators are rated A+++ to G. There are two different product labels. One for space heaters and one for combination heaters.









Seasonal space heating Energy efficiency class	
Except low temp. HP 55°C	Low temp. HP 35°C
A+++ $\eta_s \geq 150$	$\eta_s \geq 175$
A++ $125 \leq \eta_s < 150$	$150 \leq \eta_s < 175$
A+ $98 \leq \eta_s < 125$	$123 \leq \eta_s < 150$
A $90 \leq \eta_s < 98$	$115 \leq \eta_s < 123$
B $82 \leq \eta_s < 90$	$107 \leq \eta_s < 115$
C $75 \leq \eta_s < 82$	$100 \leq \eta_s < 107$
D $36 \leq \eta_s < 75$	$61 \leq \eta_s < 100$
E $34 \leq \eta_s < 36$	$59 \leq \eta_s < 61$
F $30 \leq \eta_s < 34$	$55 \leq \eta_s < 59$
G $\eta_s < 30$	$\eta_s < 55$

AIR TO WATER Series Overview

RESIDENTIAL

For New construction  For Renovation 

Monobloc type

Series	System Outline	Refrigerant	Recommended Buildings for Installation
Comfort series  Control box  Wall mounted  DHW integrated  5kW  8/10kW	Indoor unit Control box consists of the hot water circuit controller and the user interface. It is not connected to the water pipe. Outdoor unit <ul style="list-style-type: none"> Supplies 60°C hot water even when the outdoor temperature is -5°C. Supplies 55°C hot water even when the outdoor temperature is -10°C. Can be used with a variety of heating systems, including under floor heating and radiators.* Heating and DHW supply in one system.* Up to Three independent control circuits.* Operating range is -20 to 35°C in heating. Cooling operation is possible 	 REFRIGERANT R32	 

* Please refer to page W-042 to W-045 for optional parts information.

ATW Product Simplified Selection Method

Please select a product based on the amount of heat required to maintain a comfortable temperature in the house, just as with air conditioners. For example, the Split comfort series with a low Capacity Range is recommended for newly built houses, as they tend to have high thermal insulation performance.

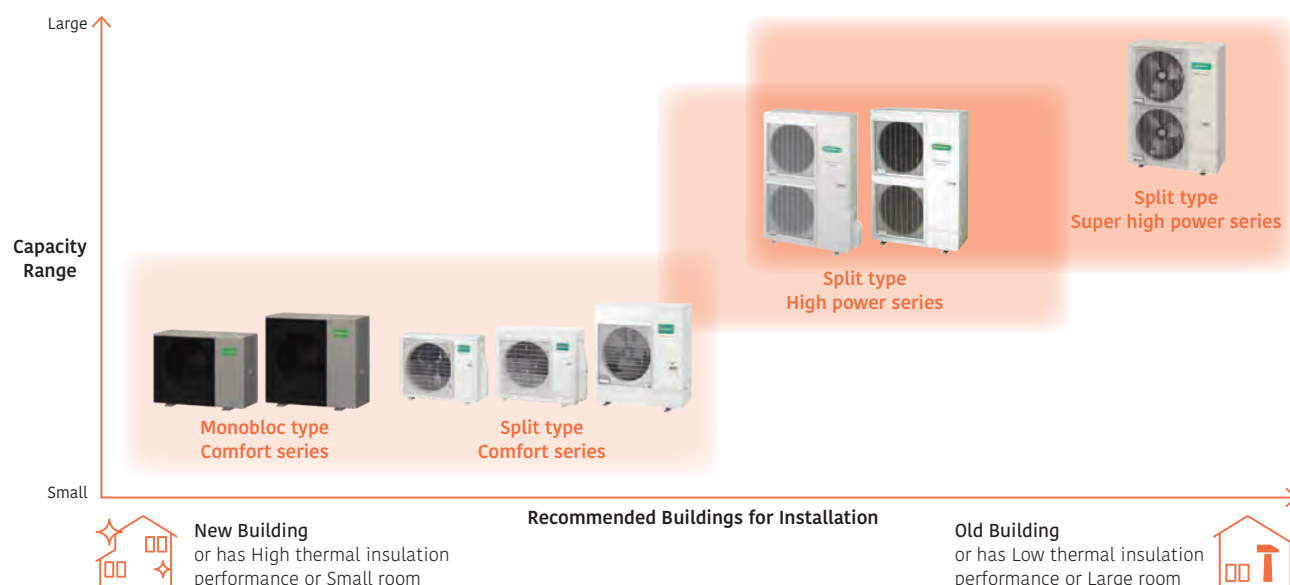

RESIDENTIAL

For New construction  For Renovation 

Split type

Series	System Outline	Refrigerant	Recommended Buildings for Installation
Comfort series  Wall mounted  DHW integrated  5/6kW  8kW  10kW	<ul style="list-style-type: none"> Supplies 55°C hot water even when the outdoor temperature is -10°C. Heating and DHW supply in one system.* Equipped with additional electric heater for backup Up to two independent control circuits.* Cooling operation is possible.* Operating range is -20 to 35°C. Can be used with a variety of heating systems, including under floor heating and radiators.* 	 REFRIGERANT R32	
High power series  Wall mounted  DHW integrated  11/14kW  11/14/16kW	<ul style="list-style-type: none"> Supplies 60°C hot water even when the outdoor temperature is -20°C. Can be used with a variety of heating systems, including under floor heating and radiators.* Heating and DHW supply in one system.* Up to two independent control circuits.* Cascade connection is possible for up to three systems.* Cooling operation is possible.* Operating range is -25 to 35°C. 	 REFRIGERANT R410A	 
Super high power series  Wall mounted  DHW integrated  16kW	<ul style="list-style-type: none"> Supplies 60°C hot water even when the outdoor temperature is -20°C. Can be used with a variety of heating systems, including under floor heating and radiators.* Heating and DHW supply in one system.* Equipped with additional electric heater for backup Up to two independent control circuits.* Cooling operation is possible.* Operating range is -25 to 35°C. 	 REFRIGERANT R410A	

* Please refer to page W-050 to W-055 for optional parts information.

AIR TO WATER Lineup

Type	Series	Refrigerant	Model	Power Source	Capacity							Approval			
					5kw	6kw	8kw	10kw	11kw	14kw	16kw	17kw	CEN KEYMARK	EHPA	
Monobloc type	Comfort series Control box type	R32 Heating & Cooling		Single phase, ~230 V, 50 Hz	UTW-SCBHC WPHG050KRF		UTW-SCBHC WPHG080KRF	UTW-SCBHC WPHG100KRF							
	Comfort series Wall-mounted type	R32 Heating & Cooling		Single phase, ~230 V, 50 Hz	WSHP100KR3 WPHG050KRF		WSHP100KR3 WPHG080KRF	WSHP100KR3 WPHG100KRF							
	Comfort series DHW Integrated type	R32 Heating & Cooling		Single phase, ~230 V, 50 Hz	WGHP100KR3-19 WPHG050KRF		WGHP100KR3-19 WPHG080KRF	WGHP100KR3-19 WPHG100KRF							
Split type	Comfort series Wall-mounted type	R32 Heating*		Single phase, ~230 V, 50 Hz	WSHA050ML3 WOHA060KLT	WSHA080ML3 WOHA060KLT	WSHA080ML3 WOHA080KLT	WSHA100ML3 WOHA100KLT							
	Comfort series DHW Integrated type	R32 Heating*		Single phase, ~230 V, 50 Hz	WGHA050ML3 WOHA060KLT	WGHA080ML3 WOHA060KLT	WGHA080ML3 WOHA080KLT	WGHA100ML3 WOHA100KLT							
	High Power series Wall-mounted type	R410A Heating*		Single phase, ~230 V, 50 Hz					WSHG140DG WOHG112LHT	WSHG140DG WOHG140LCTA					
		R410A Heating*		3-phase, ~400 V, 50 Hz					WSHG140DG WOHK112LCTA	WSHG140DG WOHK140LCTA	WSHG140DG WOHK160LCTA				
	High Power series DHW Integrated type	R410A Heating*		Single phase, ~230 V, 50 Hz					WGHG140DG WOHG112LHT	WGHG140DG WOHG140LCTA					
		R410A Heating*		3-phase, ~400 V, 50 Hz					WGHG140DG WOHK112LCTA	WGHG140DG WOHK140LCTA	WGHG140DG WOHK160LCTA				
	Super High Power series Wall-mounted type	R410A Heating*		Single phase, ~230 V, 50 Hz									WSHG160DJ6 WOHG160LJL		
	Super High Power series DHW Integrated type	R410A Heating*		Single phase, ~230 V, 50 Hz									WGHG160DJ6 WOHG160LJL		

*Cooling is available by using the option

EHPA Quality Label



Fujitsu General's Air to Water² has acquired the EHPA Quality Label³ through testing in accordance with the International Standards EN14511 and EN17025. The EHPA Quality Label³ is a label that shows the end-consumer a quality heat pump unit on the market.

²: 3-phase high power series only
³: Learn more about the validity of the mark at www.ehpa.org/quality/quality-label/

SG ready Label



SG ready is a label issued to heat pumps and their control technologies that meet the requirements set by BWP⁴, and technologies that conform to their standards can be integrated into a smart grid. SG ready labeled heat pumps receive signals from the power grid and PV systems with regard to energy and renewable energy sources such as wind, solar, and water. All of Fujitsu General's heat pump series are SG ready compatible.

⁴: BWP: Bundesverband Wärmepumpe e. V (Federal German Heat Pump Association)

The CEN Heat Pump KEYMARK



The Heat Pump KEYMARK is a full certificate supporting the quality of heat pumps in the European market. The Heat Pump KEYMARK is a voluntary, independent, European certification mark (ISO Type 5 Certification) for all heat pumps, combination heat pumps, and hot water heaters (as covered by Ecodesign, EU Regulation 813/2013 and 814/2013). Fujitsu General's Air to Water⁵ has acquired the KEYMARK certificate⁶.

⁵: R32 refrigerant comfort model only
⁶: Learn more about the validity of the mark at www.heatpumpkeymark.com/about/





Monobloc Type

Comfort series

Fits into Your Life



Monobloc type with fewer pipe works and easy installation. It provides a wide variety of solutions to meet the usage environment.

Aesthetic and Compact Design

By changing from the conventional two-fan system to a large-diameter single-fan system, we have been able to keep the height down. Because it is lower than a house window, you won't have any trouble finding a place to install the outdoor unit.



8 & 10 kW Classes

System configuration example

No refrigerant pipe is required as outdoor unit and indoor unit (or tank) are connected by water pipe

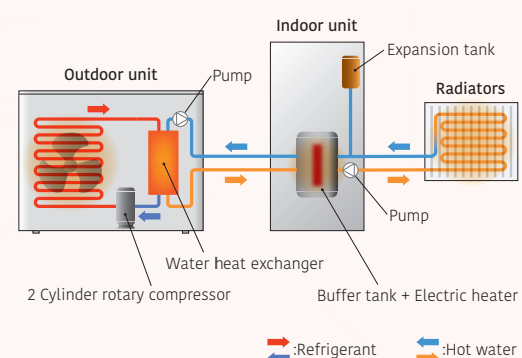

*System configuration when using Wall-mounted indoor unit

High Energy Efficiency

Energy Efficiency Class



*Temperature application: Heating temp. 35°C

Plate heat exchanger with high heat exchange performance improves energy-related product performance, achieving high energy efficiency. All classes achieved top rank A+++* energy efficiency class.

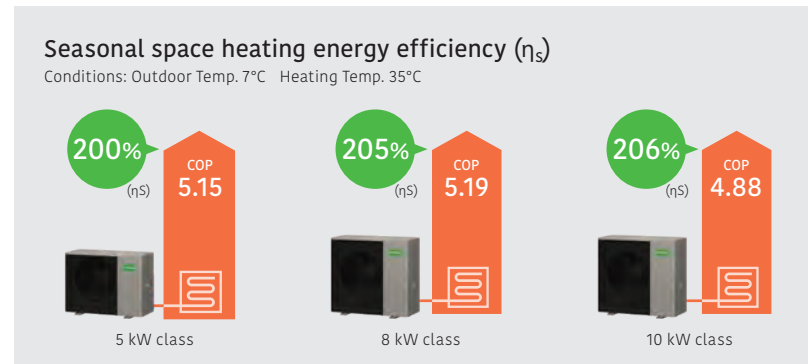

* Value when the control box is connected

5 kW class

Compact & High efficiency Plate heat exchanger

Transmitting the heat of the Refrigerant to the Water.



Inverter Technology

Inverter-equipped models operate at a capacity suited to the heat load. Because they can respond to heat loads in details inverter-equipped models are more economical and comfortable than non-inverter models. Compared to a non-inverter, it reaches the set temperature more quickly, operates at the minimum capacity and responds to slight changes in water temperature. The range of water temperature fluctuation is small, and a comfortable temperature is maintained.

Inverter technology controls temperatures precisely.

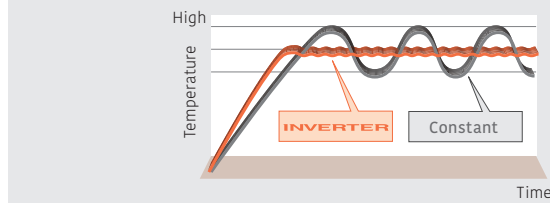

Technology to Achieve high Efficiency

High-precision parts

The precision machining of parts has improved the degree of adhesion between parts. Refrigerant leakage from gaps has been reduced, leading to improved compression efficiency and high-efficiency operation. In addition, the contact surfaces between parts have been smoothed and the amount of wear has been reduced, resulting in stable performance over a long period of time.

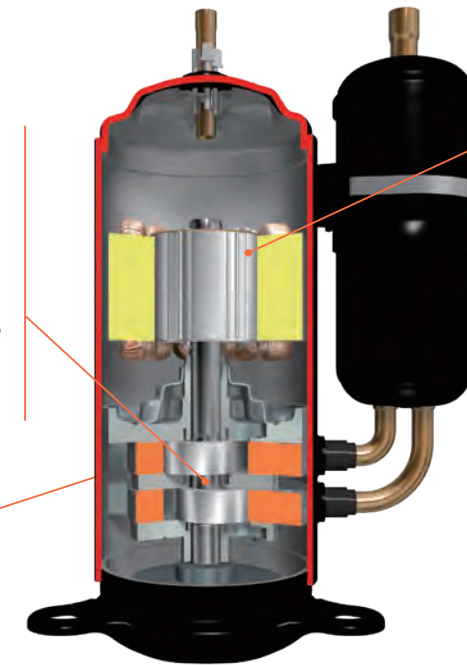

2 Cylinder rotary compressor

High-magnetic flux motor

Copper and iron losses are thoroughly suppressed to realize high magnetic flux of the motor. The high magnetic flux produces stronger torque than ever before. Thanks to this, operation with less current is possible, bringing out high-efficiency operation.



Smooth gas flow

The arrangement of parts that do not obstruct refrigerant flow in the compressor leads to highly efficient operation. Broad interpretation of the optimization of refrigerant flow paths has resulted in about 13 patents.

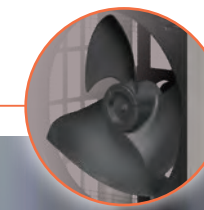

Larger fan

Low Noise Operation

In the outdoor unit, a larger fan and a sound-insulating structure in the compressor part reduce the maximum operating noise. The Monobloc outdoor unit can operate silently at 52 dB(A)* with high energy efficiency. *050 models

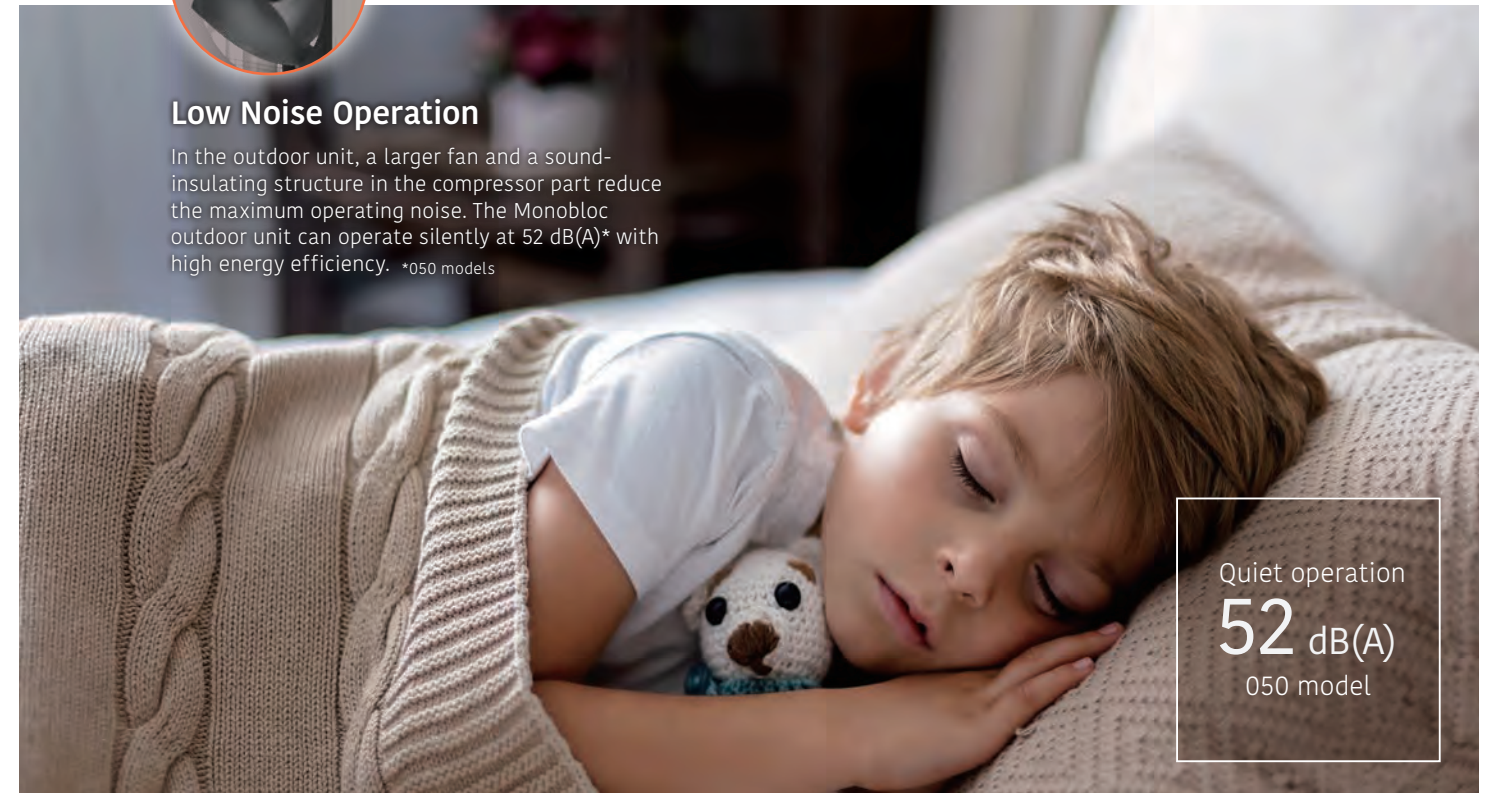

Quiet operation
52 dB(A)
050 model

Durability and Reliability

We take care to ensure that our products can be used by our customers for a long time. We have taken measures to reduce damage to our products even in the event of problems with the installation environment or during operation.



8 & 10 kW classes

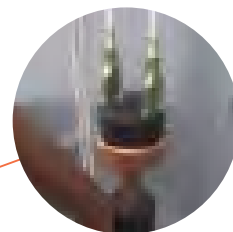

Pressure Switch

The pressure switch equipped on the refrigerant cycle protects the system from malfunction that may be caused by abnormal refrigerant pressure.



Silicon Coating of PCBs

The silicon coating protects the PCBs and their components from damage caused by small animals living in the electrical box and salt.

Optimized shaft design

- The stress on specific parts is reduced, reducing the risk of wear and damage
- Vibration during rotation is reduced, reducing wear and fatigue damage, and ultimately improving durability

DLC coating vane

- It has a very high hardness and low wear coefficient, and shows excellent resistance to wear
- It is chemically stable and has excellent resistance to various working fluids and environmental conditions, so it protects the vanes from corrosion and chemical degradation, contributing to a longer lifespan

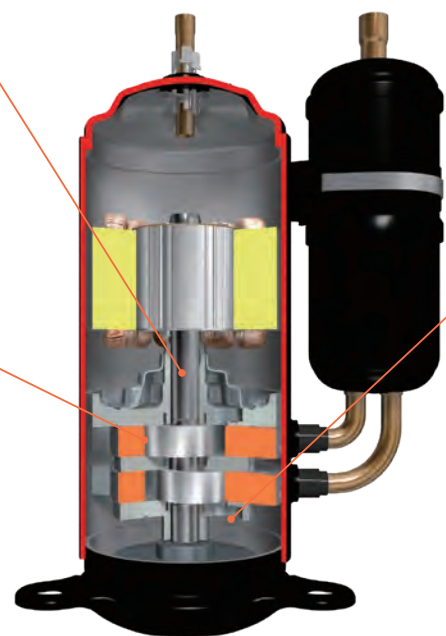

2 Cylinder rotary compressor

Technology to Increase Durability

Optimal lubricant

- Prevents friction and heating of parts, improving durability
- Contains rust-proofing and antioxidant agents, protecting metal parts from corrosion and preventing breakdowns and performance degradation
- Reduces impact between parts, suppresses vibration, and prevents excessive stress on parts, improving durability



*The values in the pictures are examples.

Service Monitor Tool

UTY-ASSXZ1



Faster & Efficient

Outdoor unit

Bluetooth Communication

AIRSTAGE Service Monitor Tool can diagnose using a smart device and reduce the working time compared with diagnosis by PC. No need to connect a PC making diagnosis easier even in narrow spaces.

Application with simple design

Application for smart devices has been released. The stylish design makes the application easy to use for everyone.



AIRSTAGE Service Monitor Tool

Refrigerant cycle diagram display

The operating status can be displayed with a simple, clear diagram*2 on the smart device. It reduces the time for diagnosis and makes diagnosis easier. It can complement abundant experience and advanced knowledge of refrigerant cycle. This shortens the training time for service personnel.

*2: List and graph displays are also available

Compact and Lightweight Design

This model is easy to carry by compact and lightweight design. The service personnel can visit the maintenance site with small luggage.



Function List

		UTY-ASSXZ1	
Product specification	Installation	Outdoor unit PCB	
	Communication	Bluetooth	
Function	Product distinction		
		Signal-type distinction	●
	Operating status display	List	●
		Graph	●
		Refrigerant cycle diagram	●
	Operating history records	●	
Adapter firmware update	●		
Adapter status monitoring	●		
Input and output of history data	●		

Specifications

	UTY-ASSXZ1
Dimensions (H x W x D) (mm)	20 x 35 x 60 (adapter)
Communication cable (cm)	60
Weight (g)	25 (adapter)
Communication method	Bluetooth 5.3
Max. communication distance (m)	10*3
Compatible device	Android8.0, iOS17 or later

*3: Depends on the environment

Serviceability and Maintainability

Easy Pipe Work

No refrigerant pipe work is required as the outdoor unit is an integrated unit. The hot water unit comes standard with the outdoor unit. Installation requires only hydraulic connection work, making installation easy.

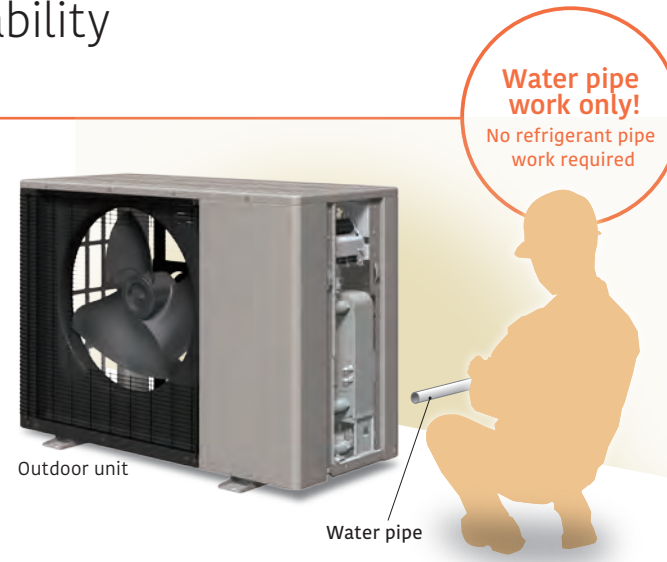

Easy Installation

Wire connections can be made simply by removing the side panel, so installation work can be easily carried out from a single direction. The compact, lightweight panel is easy to remove.



Improved Workability

- The indoor unit is equipped with a buffer tank, DHW connection 3-way valve*, as well as an expansion tank and backup heater
- This improves system reliability and ease of installation

*Wall-mounted only

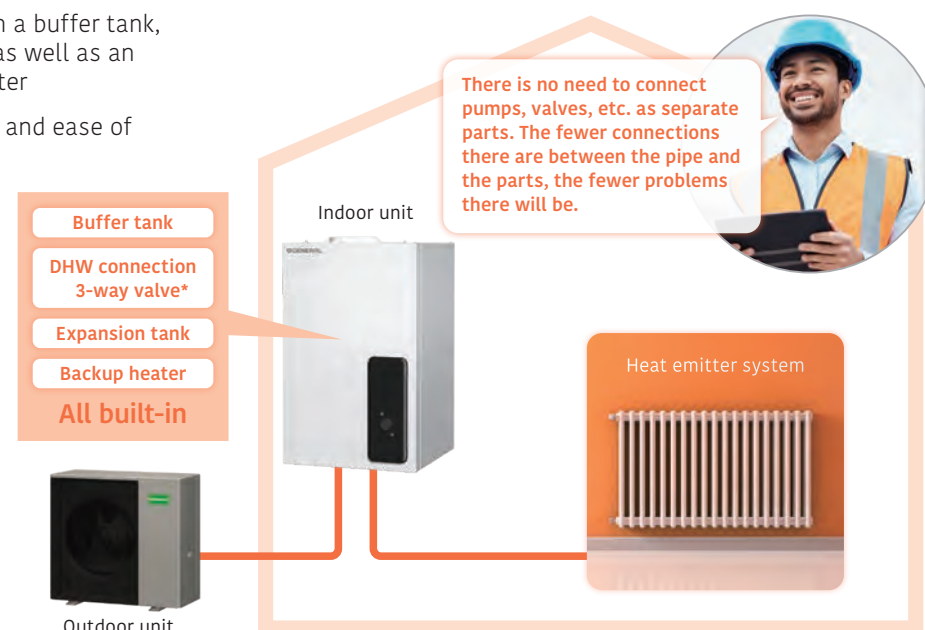

Useful Features

Features	Explanation
Quick recovery from defrosting	Maintains room temperature by boost start operation during defrosting
Auto changeover	When auto mode is selected, the system automatically switches between cooling and heating modes depending on the outside temperature.
2-zone independent control	2-zone independent control
Backup heater operation	Backup heater maintains a comfortable room temperature even when the outside temperature is low. It is intelligently controlled as a safety backup for very cold days and nights, and only operates when really needed.
Peak cut function	Sets the peak current value to reduce power consumption. Mode 1 -> 100% Mode 2 -> 75% Mode 3 -> 50% Mode 4 -> Almost 0%
Anti-Freezing function	When the outside temperature drops below a specified level, the compressor will self-activate and water will also be automatically circulated to prevent freezing.
Anti-Legionella function	Prevents the growth of Legionella bacteria in the DHW tank to supply safe and clean hot water at all times.
Emergency operation	If an outdoor unit fails to operate, a built-in backup heater or an external boiler is activated to supply an uninterrupted supply of hot water to the house.



Indoor unit:
UTW-SCBHC
 Outdoor unit:
WPHG050KRF / WPHG080KRF
WPHG100KRF



Specifications

Model Name	Indoor unit		Control box			
	Outdoor unit		WPHG050KRF	WPHG080KRF	WPHG100KRF	
Capacity Range			5	8	10	
7°C/35°C floor heating*1	Heating capacity (Max.)	kW	5.00 (8.31)	8.00 (13.28)	10.00 (15.20)	
	Input power (Max.)		0.97 (1.97)	1.54 (2.96)	2.05 (3.53)	
	COP (Max.)		5.15 (4.22)	5.19 (4.48)	4.88 (4.30)	
7°C/55°C radiator*1	Heating capacity (Max.)	kW	5.00 (7.21)	8.00 (10.60)	10.00 (11.56)	
	Input power (Max.)		1.64 (2.44)	2.62 (3.51)	3.36 (3.94)	
	COP (Max.)		3.04 (2.95)	3.05 (3.02)	2.98 (2.93)	
-7°C/55°C radiator*1	Heating capacity (Max.)	kW	4.80 (5.36)	7.50 (8.15)	8.50 (9.00)	
	Input power (Max.)		2.25 (2.57)	3.50 (3.94)	3.97 (3.94)	
	COP (Max.)		2.13 (2.09)	2.14 (2.07)	2.14 (2.93)	
35°C/18°C cooling mode*1	Cooling capacity (Max.)	kW	5.45 (6.55)	7.79 (10.87)	9.40 (10.87)	
	Input power (Max.)		1.25 (1.82)	1.69 (3.22)	2.40 (3.22)	
	EER (Max.)		4.35 (3.60)	4.62 (3.37)	3.91 (3.37)	
Space heating characteristics**						
Temperature application	°C		55	35	55	35
Energy efficiency class			A++	A+++	A++	A+++
Rated heat output (P _{rated})	kW		6	6	9	10
Seasonal space heating energy efficiency (η _s)	%		133	189	139	195
Annual energy consumption	kWh		3,110	2,364	4,880	4,018
Sound power level**3	Outdoor unit		52	52	56	57
Indoor unit specifications						
Power source	Single phase, 230 V, 50 Hz					
Dimensions H × W × D	mm		483 × 370 × 222			
Weight (Net)	kg		10			
Outdoor unit specifications						
Power source	Single phase, 230 V, 50 Hz					
Current	Max. A		14.6		19.1	
Water flow temperature range	Max. °C		60		60	
Dimensions H × W × D	mm		798 × 1,080 × 480		1,008 × 1,080 × 480	
Weight (Net)	kg		85		109	
Refrigerant	Type (Global Warming Potential)		R32 (675)		R32 (675)	
	Charge		kg		1.47	
Connection pipe	Diameter		mm		Ø25.4	
	Heating		°C		-20 to 35	

*1: Heating capacity, input power, and COP are measured using the EN14511 standard. Actual usage environments, such as the operating modes of the heating equipment, room temperature, and controller settings, may cause differences in values between those listed in the catalog and the actual performance characteristics.
 *2: Information about ErP can be downloaded from our website at www.fujitsu-general.com/global/support/downloads/search/
 *3: The sound power level values are based on EN12102 standard measurements under EN14825 standard conditions.

Dimensions

(Unit: mm)

Control box:
 UTW-SCBHC

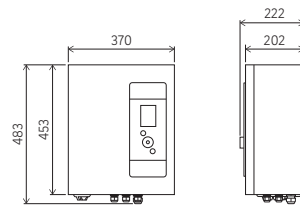

Wall Mounted:
 WSHP100KR3

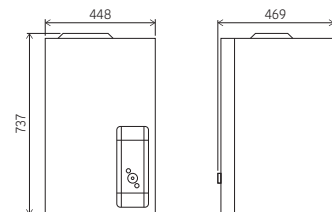

DHW Integrated:
 WGHP100KR3-19

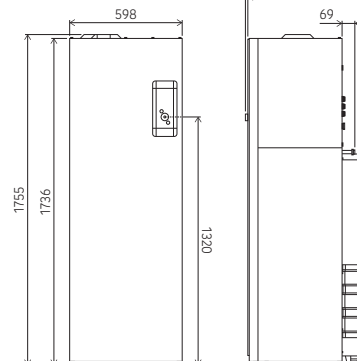

Outdoor unit:
 WPHG050KRF

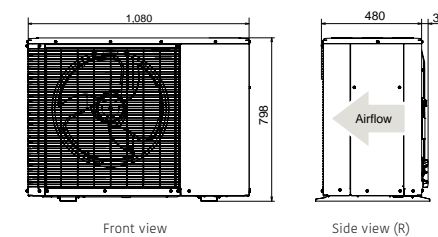

WPHG080KRF/WPHG100KRF

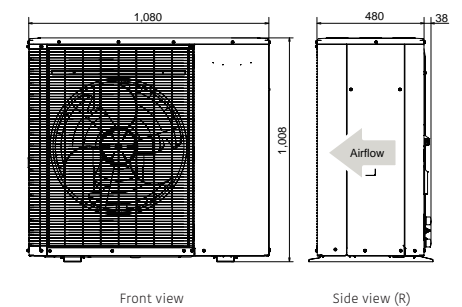

Indoor unit:
WSHP100KR3
WGHP100KR3-19
 Outdoor unit:
WPHG050KRF / WPHG080KRF
WPHG100KRF



Specifications

Model Name	Indoor unit		Wall Mounted			DHW Integrated		
	Outdoor unit		WSHP100KR3 WPHG050KRF	WSHP100KR3 WPHG080KRF	WSHP100KR3 WPHG100KRF	WGHP100KR3-19 WPHG050KRF	WGHP100KR3-19 WPHG080KRF	WGHP100KR3-19 WPHG100KRF
Capacity Range			5	8	10	5	8	10
7°C/35°C floor heating*1	Heating capacity (Max.)	kW	5.00 (8.10)	8.00 (13.07)	10.00 (14.99)	5.00 (8.10)	8.00 (13.07)	10.00 (14.99)
	Input power (Max.)		1.00 (2.00)	1.57 (3.08)	2.13 (3.64)	1.00 (2.00)	1.57 (3.08)	2.13 (3.64)
	COP (Max.)		4.99 (4.05)	5.08 (4.24)	4.70 (4.11)	4.99 (4.05)	5.08 (4.24)	4.70 (4.11)
7°C/55°C radiator*1	Heating capacity (Max.)	kW	5.00 (6.86)	8.00 (10.24)	10.00 (11.20)	5.00 (6.86)	8.00 (10.24)	10.00 (11.20)
	Input power (Max.)		1.72 (2.47)	2.62 (3.55)	3.40 (3.99)	1.72 (2.47)	2.62 (3.55)	3.40 (3.99)
	COP (Max.)		2.91 (2.77)	3.05 (2.89)	2.94 (2.81)	2.91 (2.77)	3.05 (2.89)	2.94 (2.81)
-7°C/55°C radiator*1	Heating capacity (Max.)	kW	4.80 (4.90)	7.50 (7.69)	8.50 (8.54)	4.80 (4.90)	7.50 (7.69)	8.50 (8.54)
	Input power (Max.)		2.51 (2.62)	3.62 (3.99)	4.11 (4.35)	2.51 (2.62)	3.62 (3.99)	4.11 (4.35)
	COP (Max.)		1.91 (1.87)	2.07 (1.93)	2.07 (1.96)	1.91 (1.87)	2.07 (1.93)	2.07 (1.96)
35°C/18°C cooling mode*1	Cooling capacity (Max.)	kW	5.35 (6.42)	7.69 (10.75)	9.30 (10.75)	5.35 (6.42)	7.69 (10.75)	9.30 (10.75)
	Input power (Max.)		1.26 (1.85)	1.72 (3.32)	2.47 (3.32)	1.26 (1.85)	1.72 (3.32)	2.47 (3.32)
	EER (Max.)		4.23 (3.48)	4.47 (3.24)	3.77 (3.24)	4.23 (3.48)	4.47 (3.24)	3.77 (3.24)
Space heating characteristics**								
Temperature application	°C		55	35	55	35	55	35
Energy efficiency class			A++	A+++	A++	A+++	A++	A+++
Rated heat output (P _{rated})	kW		6	6	9	10	10	10
Seasonal space heating energy efficiency (η _s)	%		133	189	139	195	141	195
Annual energy consumption	kWh		3,355	2,503	5,078	3,764	5,685	4,269
Sound power level**3	Outdoor unit		52	52	56	56	57	57
Indoor unit specifications								
Power source	Single phase, 230 V, 50 Hz							
Dimensions H × W × D	mm		737 × 448 × 469			1755 × 598 × 623		
Weight (Net)	kg		34.0			130.0		
Water circulation	Min./Max. L/min		8.5			14.5		
DHW tank volume	L		-			190		
Buffer tank capacity	L		16			16		
Expansion vessel capacity	L		12			12		
Water flow temperature range	Max. °C		60			60		
Water pipe connection diameter	Flow/Return		mm			mm		
Electrical heater capacity	Heating		kW			kW		
	DHW		-			1.2		
Declared load profile			-			L		
Efficiency η _{DHW}	%		-			124		
Heating up time			-			1h45min		
COP(EN16147)			-			3.10		
Outdoor unit specifications								
Power source	Single phase, 230 V, 50 Hz							
Current	Max. A		14.6		19.1		20.6	
Water flow temperature range	Max. °C		60		60		60	
Dimensions H × W × D	mm		798 × 1,080 × 480		1,008 × 1,080 × 480		1,008 × 1,080 × 480	
Weight (Net)	kg		85		109		109	
Refrigerant	Type (Global Warming Potential)		R32 (675)		R32 (675)		R32 (675)	
	Charge		kg		1.47		1.47	
Connection pipe	Diameter		mm		Ø25.4		Ø25.4	
	Heating		°C		-20 to 35		-20 to 35	

*1: Heating capacity, input power, and COP are measured using the EN14511 standard. Actual usage environments, such as the operating modes of the heating equipment, room temperature, and controller settings, may cause differences in values between those listed in the catalog and the actual performance characteristics.
 *2: Information about ErP can be downloaded from our website at www.fujitsu-general.com/global/support/downloads/search/
 *3: The sound power level values are based on EN12102 standard measurements under EN14825 standard conditions.



Split Type Comfort series



Split Type High Power series Super High Power series

This is a split type that exchanges heat from Air to Water inside the indoor unit.

A wide range of products to suit regional characteristics, family structures, and usage patterns. We provide a variety of products to meet the needs of customers from the heating-centered high power series to the reasonably priced compact series.

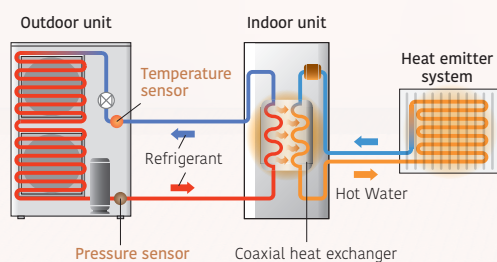

*Indoor unit : Wall-mounted

High Energy Efficiency

All classes achieved top rank A+++* energy efficiency class.



For Outdoor Unit

Twin-Rotary Compressor with Linear Control Injection Port

The compressor achieves a high condensing temperature without overheating the discharge gas temperature due to the Linear control injection process used during compression. This makes the condensing temperature higher than in a normal circuit. Higher water temperatures can be achieved by controlling the injection volume according to usage conditions.

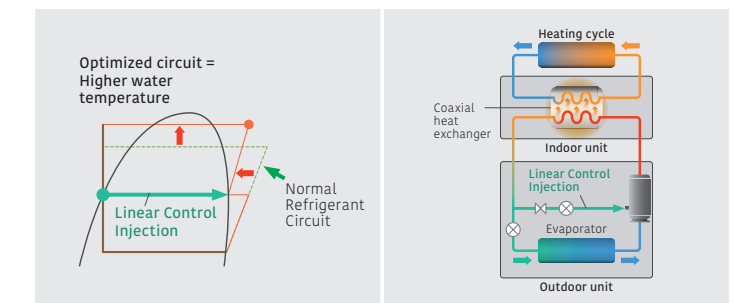

*High power and super high power only

For Indoor Unit

High-durability coaxial heat exchanger

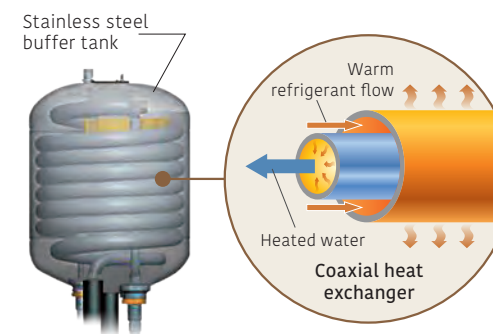

Stainless Steel Buffer Tank

Heat exchange amount is 25% higher than the previous model. Energy-saving performance has also been improved. The buffer tank has anti-corrosion protection thanks to stainless steel material.

Class A Pump

Energy-saving pump with the ability to adjust the flow rate and pressure to a constant level



Durability and Reliability

We take care to ensure that our products can be used by our customers for a long time. We have taken measures to reduce damage to our products even in the event of problems with the installation environment or during operation.



For Outdoor Unit

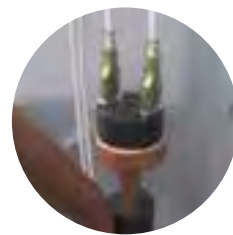

Pressure Switch

The pressure switch equipped on the refrigerant cycle protects the system from malfunction that may be caused by abnormal refrigerant pressure.

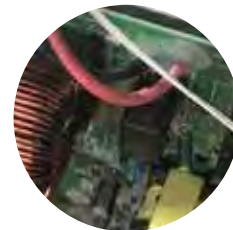

Silicon Coating of PCBs

The silicon coating protects the PCBs and their components from damage caused by small animals living in the electrical box and salt.

2 Cylinder Rotary Compressor

Optimal bearings

Reduced stress on specific parts of the body reduces the risk of wear and tear. Reduced vibration during rotation reduces wear and fatigue damage, resulting in increased durability.

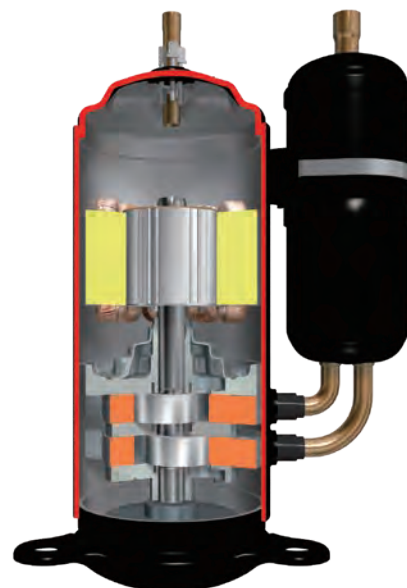

Coated vane

• Very high hardness and low coefficient of wear, providing excellent resistance to abrasion. Scientifically stable and highly resistant to a wide range of working fluids and environmental conditions, it protects vanes from corrosion and chemical degradation, contributing to longer service life.

Optimal lubricating oil

• Improves durability by preventing friction and heating of parts
 • Contains rust inhibitors and antioxidants to protect metal parts from corrosion, which can cause failure and loss of performance.
 • Reduces shock and vibration between parts, preventing overstressing of parts and increasing durability

Useful Features

Features	Explanation
Quick recovery from defrosting	Maintains room temperature by boost start operation during defrosting
Auto changeover	When cooling mode is selected, the system automatically switches between cooling and heating modes depending on the outside temperature.
2-zone independent control	2-zone independent control
Backup heater operation	Backup heater maintains a comfortable room temperature even when the outside temperature is low. It is intelligently controlled as a safety backup for very cold days and nights, and only operates when really needed.
Peak cut function	Sets the peak current value to reduce power consumption. Mode 1 -> 100% Mode 2 -> 75% Mode 3 -> 50% Mode 4 -> Almost 0%
Anti-Freezing function	When the outside temperature drops below a specified level, the compressor will self-activate and water will also be automatically circulated to prevent freezing.
Anti-Legionella function	Prevents the growth of Legionella bacteria in the DHW tank to supply safe and clean hot water at all times.
Emergency operation	If an outdoor unit fails to operate, a built-in backup heater or an external boiler is activated to supply an uninterrupted supply of hot water to the house.

Smart Control

To meet the diverse needs of customers, we offer a variety of control options, such as individual control and remote control options.

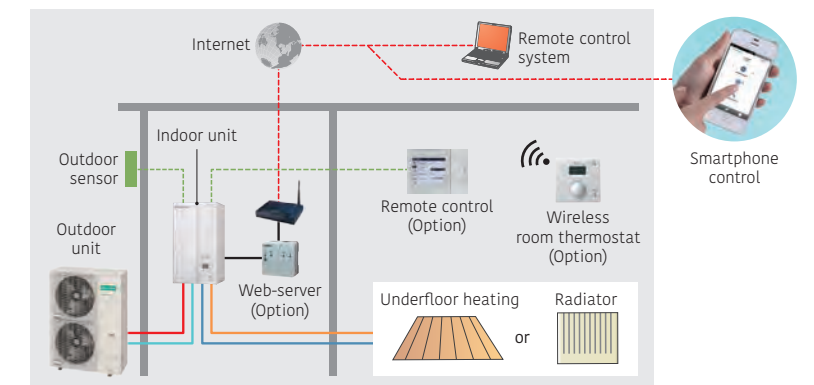

Split Type

Wall Mounted type

Comfort series



Indoor unit:
WSHA050ML3 / WSHA080ML3 /
WSHA100ML3
Outdoor unit:
WOHA060KLT / WOHA080KLT /
WOHA100KLT



Specifications

Model Name	Indoor unit	Outdoor unit	WSHA050ML3	WSHA080ML3	WSHA080ML3	WSHA100ML3				
Capacity Range			5	6	8	10				
7°C/35°C floor heating *1	Heating capacity (Max.)	kW	4.50 (7.64)	5.50 (8.93)	7.50 (9.64)	9.50 (15.29)				
	Input power (Max.)		0.949 (1.80)	1.18 (2.24)	1.69 (2.46)	2.11 (3.89)				
	COP (Max.)		4.74 (4.24)	4.65 (3.99)	4.43 (3.92)	4.50 (3.93)				
2°C/35°C floor heating *1	Heating capacity	kW	4.50	5.30	6.30	9.30				
	Input power		1.33	1.65	1.96	3.08				
	COP		3.39	3.22	3.21	3.02				
-7°C/35°C floor heating *1	Heating capacity (Max.)	kW	4.40 (4.97)	5.00 (6.13)	5.70 (7.05)	8.90 (10.40)				
	Input power (Max.)		1.59 (1.67)	1.90 (2.12)	2.13 (2.55)	3.36 (3.62)				
	COP (Max.)		2.76 (2.98)	2.63 (2.89)	2.68 (2.76)	2.65 (2.87)				
-7°C/55°C Radiator *1	Heating capacity (Max.)	kW	3.90 (4.24)	4.25 (4.86)	5.30 (5.85)	8.00 (8.00)				
	Input power (Max.)		2.11 (2.25)	2.25 (2.69)	2.79 (3.26)	4.10 (4.10)				
	COP (Max.)		1.85 (1.88)	1.89 (1.81)	1.90 (1.79)	1.95 (1.95)				
Space heating characteristics*2										
Temperature application	°C		55	35	55	35	55	35	55	35
Energy efficiency class			A++	A+++	A++	A+++	A++	A+++	A++	A+++
Rated heat output (P _{rated})	kW		5	5	6	6	7	8	9	9
Seasonal space heating energy efficiency (η _s)	%		125	175	125	175	128	177	130	178
Annual energy consumption	kWh		3,035	2,322	3,411	2,594	3,903	2,982	5,083	3,875
Sound power level*3	Indoor unit	dB(A)	40	-	40	-	40	-	40	-
	Outdoor unit		57	-	57	-	60	-	62	-
Indoor unit specifications										
Power source	Single phase, ~230 V, 50 Hz									
Dimensions H × W × D	mm		847 × 450 × 493	847 × 450 × 493	847 × 450 × 493	847 × 450 × 493				
Weight (Net)	kg		47	47	47	47				
Water circulation	Min./Max.	L/min	7.6/22.0	8.5/22.0	10.0/22.0	13.2/30.0				
Buffer tank capacity		L	16	16	16	16				
Expansion vessel capacity		L	8	8	8	8				
Water flow temperature range	Max.	°C	55	55	55	55				
Water pipe connection diameter	Flow/Return	mm	Ø25.4/Ø25.4	Ø25.4/Ø25.4	Ø25.4/Ø25.4	Ø25.4/Ø25.4				
Electrical heater capacity	Heating	kW	3.0	3.0	3.0	3.0				
Outdoor unit specifications										
Power source	Single phase, ~230 V, 50 Hz									
Current	Max.	A	13.0	13.0	18.0	19.0				
Dimensions H × W × D	mm		632 × 799 × 290	632 × 799 × 290	716 × 820 × 315	998 × 940 × 320				
Weight (Net)	kg		39	39	42	62				
Refrigerant	Type (Global Warming Potential)		R32 (675)	R32 (675)	R32 (675)	R32 (675)				
	Charge	kg	0.97	0.97	1.02	1.63				
Additional refrigerant charge		g/m	25	25	25	20				
Connection pipe	Diameter	Liquid	mm	6.35	6.35	6.35	9.52			
		Gas		12.70	12.70	12.70	15.88			
	Length	Min./Max.	m	3/30	3/30	3/30	3/30			
		Length (Pre-charge)	m	15	15	15	20			
Height difference	Max.	m	20	20	20	20				
Operating range	Heating	°C	-20 to 35	-20 to 35	-20 to 35	-20 to 35				

High Water Flow Temperature

The temperature of water flow is up to 55°C without a backup heater. Hot water supply temperature can be maintained even at -10°C outdoor temperature.

* If you want to raise the temperature of the water supply to above the maximum temperature, use a backup heater to supplement the primary heater.



High COP

Heat pumps of ATW Systems work more efficiently and consume less energy than conventional heating systems.

Energy efficiency class



*Temperature application: Heating temp. 35°C

Seasonal space heating energy efficiency (η_s)

Conditions: Outdoor Temp. 7°C Heating Temp. 35°C

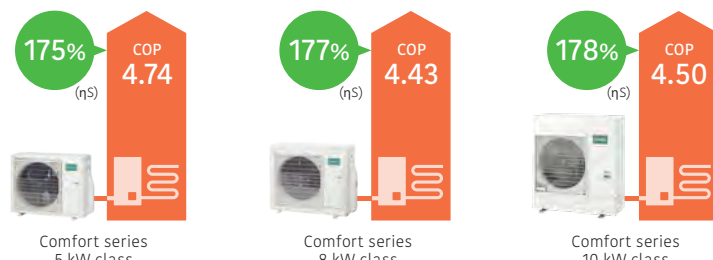

Outdoor unit technology



DC Fan Motor
 High-performance, high-efficiency small DC fan motor mounted

DC Twin-Rotary Compressor
 High-efficiency DC twin-rotary compressor

DC Inverter
 DC inverter provides smooth water temperature control.

*1: Heating capacity, input power, and COP are measured using the EN14511 standard. Actual usage environments, such as the operating modes of the heating equipment, room temperature, and controller settings, may cause differences in values between those listed in the catalog and the actual performance characteristics.
 *2: Information about ErP can be downloaded from our website at www.fujitsu-general.com/global/support/downloads/search/
 *3: The sound power level values are based on EN12102 standard measurements under EN14825 standard conditions.

Dimensions

(Unit: mm)

Outdoor Unit:
 WOHA060KLT

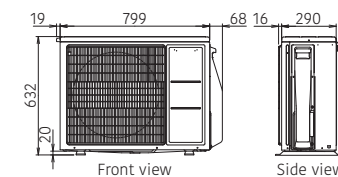

WOHA080KLT

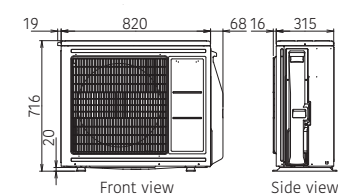

WOHA100KLT

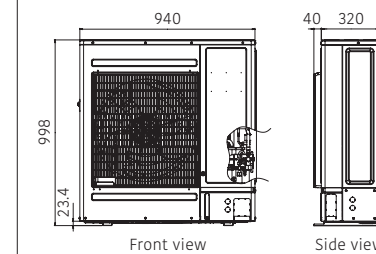

Indoor Unit:
 WSHA050ML3/WSHA080ML3/WSHA100ML3

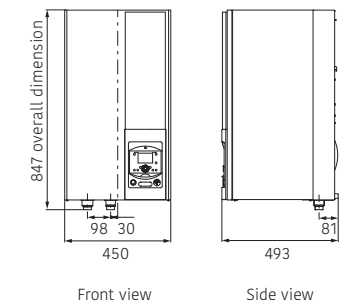

Split Type

DHW Integrated type

Comfort series



Indoor unit:
WGHA050ML3 / WGHA080ML3 /
WGHA100ML3
Outdoor unit:
WOHA060KLT / WOHA080KLT /
WOHA100KLT



Specifications

Model Name	Indoor unit	Outdoor unit	WGHA050ML3 WOHA060KLT	WGHA080ML3 WOHA080KLT	WGHA080ML3 WOHA080KLT	WGHA100ML3 WOHA100KLT
Capacity range			5	6	8	10
7°C/35°C floor heating *1	Heating capacity (Max.)	kW	4.50 (7.64)	5.50 (8.93)	7.50 (9.64)	9.50 (15.29)
	Input power (Max.)		0.949 (1.80)	1.18 (2.24)	1.69 (2.46)	2.11 (3.89)
	COP (Max.)		4.74 (4.24)	4.65 (3.99)	4.43 (3.92)	4.50 (3.93)
2°C/35°C floor heating *1	Heating capacity	kW	4.50	5.30	6.30	9.30
	Input power		1.33	1.65	1.96	3.08
	COP		3.39	3.22	3.21	3.02
-7°C/35°C floor heating *1	Heating capacity (Max.)	kW	4.40 (4.97)	5.00 (6.13)	5.70 (7.05)	8.90 (10.40)
	Input power (Max.)		1.59 (1.67)	1.90 (2.12)	2.13 (2.55)	3.36 (3.62)
	COP (Max.)		2.76 (2.98)	2.63 (2.89)	2.68 (2.76)	2.65 (2.87)
-7°C/55°C Radiator *1	Heating capacity (Max.)	kW	3.90 (4.24)	4.25 (4.86)	5.30 (5.85)	8.00 (8.00)
	Input power (Max.)		2.11 (2.25)	2.25 (2.69)	2.79 (3.26)	4.10 (4.10)
	COP (Max.)		1.85 (1.88)	1.89 (1.81)	1.90 (1.79)	1.95 (1.95)
Space heating characteristics*2						
Temperature application	°C		55	35	55	35
Energy efficiency class			A++	A+++	A++	A+++
Rated heat output (P _{rated})	kW		5	5	6	7
Seasonal space heating energy efficiency (η _s)	%		125	175	125	177
Annual energy consumption	kWh		3,035	2,322	3,411	2,594
Sound power level*3	Indoor unit	dB(A)	40	-	40	-
	Outdoor unit		57	-	60	-
Domestic hot water characteristics*2						
Load profile			L	L	L	L
Energy efficiency class			A+	A+	A+	A+
Energy efficiency (n _{wh})	%		130	130	130	130
Annual electricity consumption	kWh		793	793	793	793
Indoor unit specifications						
Power source	Single phase, ~230 V, 50 Hz					
Dimensions H × W × D	mm		1,863 × 648 × 700	1,863 × 648 × 700	1,863 × 648 × 700	1,863 × 648 × 700
Weight (Net)	kg		145	145	145	145
Water circulation	Min./Max.	L/min	7.6/22.0	8.5/22.0	10.0/22.0	13.2/30.0
DHW tank volume		L	190	190	190	190
Electrical heater capacity	Heating	kW	3.0	3.0	3.0	3.0
	DHW		1.5	1.5	1.5	1.5
Buffer tank capacity		L	16	16	16	16
Expansion vessel capacity		L	8	8	8	8
Water flow temperature range	Max.	°C	55	55	55	55
Water pipe connection diameter	Flow/Return	mm	Ø25.4/Ø25.4	Ø25.4/Ø25.4	Ø25.4/Ø25.4	Ø25.4/Ø25.4
Hot water pipe connection diameter		mm	Ø19.05	Ø19.05	Ø19.05	Ø19.05
Outdoor unit specifications						
Power source	Single phase, ~230 V, 50 Hz					
Current	Max.	A	13.0	13.0	18.0	19.0
Dimensions H × W × D	mm		632 × 799 × 290	632 × 799 × 290	716 × 820 × 315	998 × 940 × 320
Weight (Net)	kg		39	39	42	62
Refrigerant	Type (Global Warming Potential)		R32 (675)	R32 (675)	R32 (675)	R32 (675)
	Charge	kg	0.97	0.97	1.02	1.63
Additional refrigerant charge		g/m	25	25	25	20
	Diameter	Liquid	6.35	6.35	6.35	9.52
Connection pipe		Gas	12.70	12.70	12.70	15.88
	Length	Min./Max.	m	3/30	3/30	3/30
	Length (Pre-charge)		m	15	15	20
	Height difference	Max.	m	20	20	20
Operating range	Heating	°C	-20 to 35	-20 to 35	-20 to 35	-20 to 35

High Water Flow Temperature

The temperature of water flow is up to 55°C without a backup heater. Hot water supply temperature can be maintained even at -10°C outdoor temperature.

* If you want to raise the temperature of the water supply to above the maximum temperature, use a backup heater to supplement the primary heater.



High COP

Heat pumps of ATW Systems work more efficiently and consume less energy than conventional heating systems.

Energy efficiency class



*Temperature application: Heating temp. 35°C

Seasonal space heating energy efficiency (η_s)

Conditions: Outdoor Temp. 7°C Heating Temp. 35°C

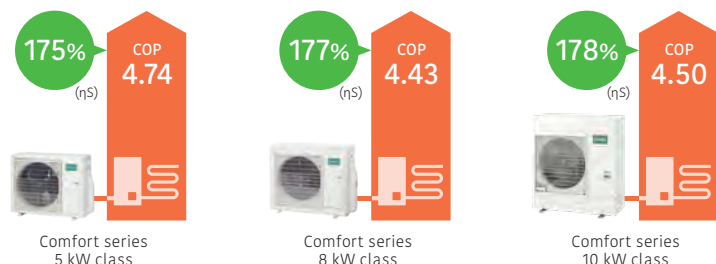

Outdoor Unit Technology



DC Fan Motor
High-performance, high-efficiency small DC fan motor mounted

DC Twin-Rotary Compressor
High-efficiency DC twin-rotary compressor

DC Inverter
DC inverter provides smooth water temperature control.

*1: Heating capacity, input power, and COP are measured using the EN14511 standard. Actual usage environments, such as the operating modes of the heating equipment, room temperature, and controller settings, may cause differences in values between those listed in the catalog and the actual performance characteristics.
 *2: Information about ERP can be downloaded from our website at www.fujitsu-general.com/global/support/downloads/search/
 *3: The sound power level values are based on EN12102 standard measurements under EN14825 standard conditions.

Dimensions

(Unit: mm)

Outdoor Unit:
 WOHA060KLT

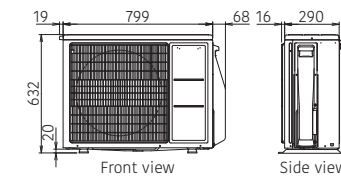

WOHA080KLT

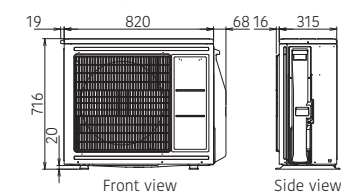

WOHA100KLT

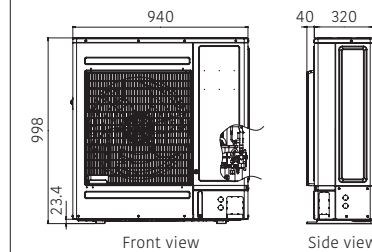

Indoor Unit:
 WGHA050ML3/WGHA080ML3/WGHA100ML3

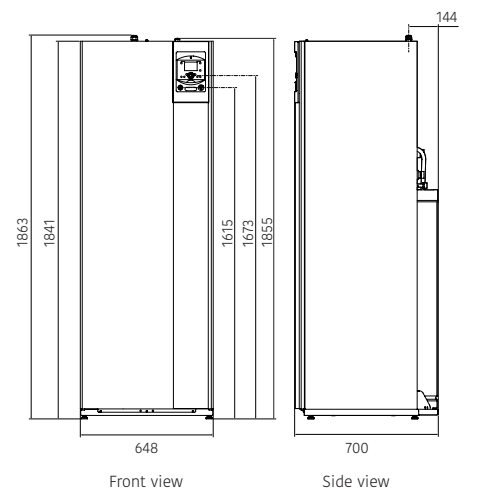

Split Type

Wall-Mounted type

High Power series



REFRIGERANT R410A

A+

A++

Max 60°C

High Water Flow Temperature

The temperature of water flow can be maintained at 60°C without using a backup heater, even when the outdoor temperature drops to -20°C.

* If you want to raise the temperature of the water supply to above the maximum temperature, use a backup heater to supplement the primary heater.



High COP

Heat pumps of ATW Systems work more efficiently and consume less energy than conventional heating systems.

Energy efficiency class

A++*

*Temperature application: Heating temp. 35°C

Seasonal space heating energy efficiency (η_s)

Conditions: Outdoor Temp. 7°C Heating Temp. 35°C

151% (η_s) COP 4.25

154% (η_s) COP 4.30

Single phase 11 kW class

3-phase 11 kW class



Indoor unit:
WSHG140DG

Outdoor unit:
WOHG112LHT / WOHG140LCTA
[3-phase] WOHK112LCTA /
WOHK140LCTA /WOHK160LCTA



Specifications

Model Name	Indoor unit	Outdoor unit	WSHG140DG WOHG112LHT	WSHG140DG WOHG140LCTA	WSHG140DG WOHK112LCTA	WSHG140DG WOHK140LCTA	WSHG140DG WOHK160LCTA
Capacity range			11	14	11	14	16
7°C/35°C floor heating *1	Heating capacity	kW	10.80	13.50	10.80	13.50	15.17
	Input power		2.54	3.23	2.51	3.20	3.70
	COP		4.25	4.18	4.30	4.22	4.10
2°C/35°C floor heating *1	Heating capacity	kW	10.77	12.00	10.77	13.00	13.50
	Input power		3.44	3.87	3.40	4.15	4.34
	COP		3.13	3.10	3.17	3.13	3.11
-7°C/35°C floor heating*1	Heating capacity	kW	10.38	11.54	10.38	12.20	13.50
	Input power		4.32	5.08	4.28	5.13	5.40
	COP		2.40	2.27	2.43	2.38	2.50
-7°C/55°C Radiator*1	Heating capacity	kW	7.57	9.20	9.27	10.10	11.00
	Input power		4.57	5.08	5.09	5.65	6.29
	COP		1.66	1.81	1.82	1.79	1.75

Space heating characteristics*2

Temperature application	°C	55	35	55	35	55	35	55	35	55	35
Energy efficiency class		A+	A++	A+	A+	A+	A++	A+	A++	A+	A+
Rated heat output (P _{rated})	kW	9	11	11	13	9	11	11	13	13	14
Seasonal space heating energy efficiency (η _s)	%	112	151	113	148	112	154	117	150	117	149
Annual energy consumption	kWh	6,704	6,062	8,041	6,824	6,669	5,930	7,803	6,738	9,062	7,408
Sound power level	Indoor unit	46		46		46		46		46	
	Outdoor unit	68		69		69		70		68	

Indoor unit specifications

Power source		Single phase, ~230 V, 50 Hz	3-phase, ~400 V, 50 Hz
Dimensions H × W × D	mm	800 × 450 × 457	
Weight (Net)	kg	40	
Water circulation	Min./Max. L/min	19.5/39.0	24.4/48.7
Buffer tank capacity	L	16	
Expansion vessel capacity	L	8	
Water flow temperature range	Max. °C	60	
Water pipe connection diameter	Flow/Return mm	Ø25.4/Ø25.4	
Electrical heater capacity	heating kW	-	

Outdoor unit specifications

Power source		Single phase, ~230 V, 50 Hz	3-phase, ~400 V, 50 Hz
Current	Max. A	22.0	25.0
Dimensions H × W × D	mm	1,290 × 900 × 330	
Weight (Net)	kg	92	99
Refrigerant	Type (Global Warming Potential)	R410A (2,088)	
	Charge	kg	
Additional refrigerant charge	Liquid	g/m	
	Gas	g/m	
Connection pipe	Diameter	Liquid mm	Ø9.52
		Gas mm	Ø15.88
	Length	Min./Max. m	5/20
	Length (Pre-charge)	m	15
Height difference	Max. m	15	
	Heating °C	-25 to 35	

*1: Heating capacity, input power, and COP are measured using the EN14511 standard. Actual usage environments, such as the operating modes of the heating equipment, room temperature, and controller settings, may cause differences in values between those listed in the catalog and the actual performance characteristics.

*2: Information about ErP can be downloaded from our website at www.fujitsu-general.com/global/support/downloads/search/

Dimensions

(Unit: mm)

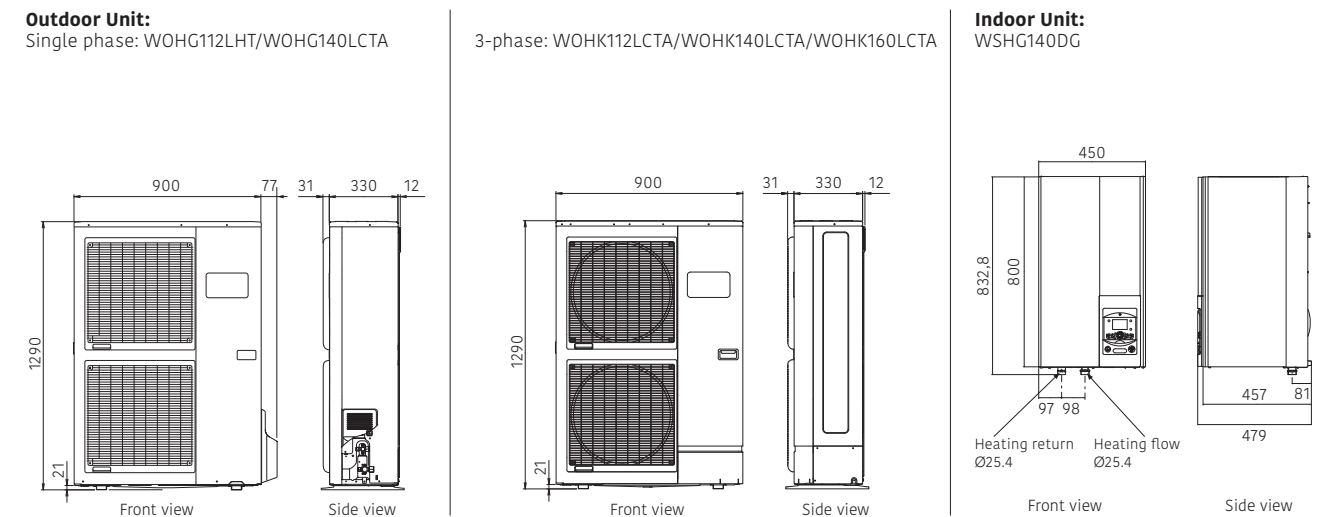

Split Type

DHW Integrated type

High Power series



High Water Flow Temperature

The temperature of water flow can be maintained at 60°C without using a backup heater, even when the outdoor temperature drops to -20°C.

* If you want to raise the temperature of the water supply to above the maximum temperature, use a backup heater to supplement the primary heater.



High COP

Heat pumps of ATW Systems work more efficiently and consume less energy than conventional heating systems.



*Temperature application: Heating temp. 35°C

Seasonal space heating energy efficiency (η_s)

Conditions: Outdoor Temp. 7°C Heating Temp. 35°C

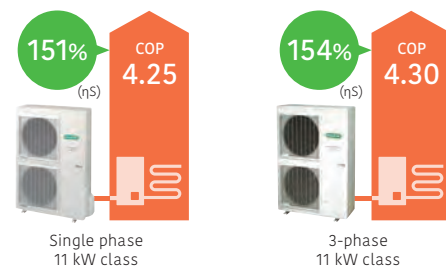

Optimized Refrigerant Cycle Operation

The high power series deliver high performance and efficiency with twin sensors and hot water heating technology.

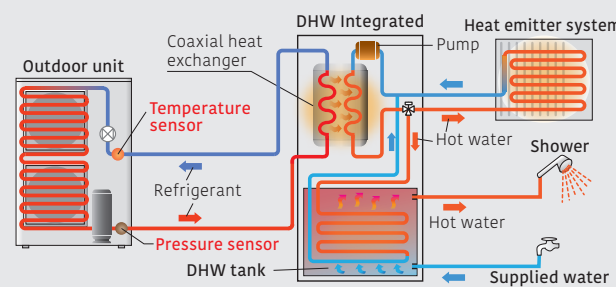

Indoor unit:
WGHG140DG
Outdoor unit:
WOHG112LHT / WOHG140LCTA
[3-phase] WOHK112LCTA / WOHK140LCTA / WOHK160LCTA



Specifications

Model Name	Indoor unit		WGHG140DG		WGHG140DG		WGHG140DG		WGHG140DG	
	Outdoor unit		WOHG112LHT	WOHG140LCTA	WOHK112LCTA	WOHK140LCTA	WOHK140LCTA	WOHK160LCTA		
Capacity range			11	14	11	14	14	16		
7°C/35°C floor heating *1	Heating capacity	kW	10.80	13.50	10.80	13.50	13.50	15.17		
	Input power		2.54	3.23	2.51	3.20	3.70	4.10		
	COP		4.25	4.18	4.30	4.22	4.10	4.10		
2°C/35°C floor heating *1	Heating capacity	kW	10.77	12.00	10.77	13.00	13.50	13.50		
	Input power		3.44	3.87	3.40	4.15	4.34	4.34		
	COP		3.13	3.10	3.17	3.13	3.11	3.11		
-7°C/35°C floor heating*1	Heating capacity	kW	10.38	11.54	10.38	12.20	13.50	13.50		
	Input power		4.32	5.08	4.28	5.13	5.40	5.40		
	COP		2.40	2.27	2.43	2.38	2.50	2.50		
-7°C/55°C Radiator*1	Heating capacity	kW	7.57	9.20	9.27	10.10	11.00	11.00		
	Input power		4.57	5.08	5.09	5.65	6.29	6.29		
	COP		1.66	1.81	1.82	1.79	1.75	1.75		
Space heating characteristics*2										
Temperature application	°C		55	35	55	35	55	35	55	35
Energy efficiency class			A+	A++	A+	A+	A+	A++	A+	A+
Rated heat output (P _{rated})	kW		9	11	11	13	9	11	13	14
Seasonal space heating energy efficiency (η_s)	%		112	151	113	148	112	154	117	149
Annual energy consumption	kWh		6,704	6,062	8,041	6,824	6,669	5,930	7,803	6,738
Sound power level	Indoor unit	dB(A)	46		46		46		46	
	Outdoor unit		68		69		69		68	
Domestic hot water characteristics*2										
Load profile	L									
Energy efficiency class	A									
Energy efficiency (η_w)	%									
Annual electricity consumption	kWh									
Indoor unit specifications										
Power source	Single phase, ~230 V, 50 Hz					3-phase, ~400 V, 50 Hz				
Dimensions H × W × D	mm		1,840 × 648 × 698							
Weight (Net)	kg		150							
Water circulation	Min./Max.	L/min	19.5/39.0	24.4/28.7	19.5/39.0	24.4/48.7	27.4/54.8			
DHW tank volume	L		190							
Electrical heater capacity	Heating	kW	-							
	DHW		1.5							
Buffer tank capacity	L		16							
Expansion vessel capacity	L		12							
Water flow temperature range	Max.	°C	60							
Water pipe connection diameter	Flow/Return	mm	Ø25.4/Ø25.4							
Hot water pipe connection diameter	mm		Ø19.05							
Outdoor unit specifications										
Power source	Single phase, ~230 V, 50 Hz					3-phase, ~400 V, 50 Hz				
Current	Max.	A	22.0	25.0	9.0	9.5	10.5			
Dimensions H × W × D	mm		1,290 × 900 × 330							
Weight (Net)	kg		92							
Refrigerant	Type (Global Warming Potential)	R410A (2,088)								
	Charge	kg	2.50							
Additional refrigerant charge	g/m		50							
	Diameter	Liquid	Ø9.52							
Connection pipe	Gas	mm	Ø15.88							
	Length	Min./Max.	m							
	Length (Pre-charge)	m	5/20							
	Height difference	Max.	m							
Operating range	Heating	°C	-25 to 35							

*1: Heating capacity, input power, and COP are measured using the EN14511 standard. Actual usage environments, such as the operating modes of the heating equipment, room temperature, and controller settings, may cause differences in values between those listed in the catalog and the actual performance characteristics.
 *2: Information about ErP can be downloaded from our website at www.fujitsu-general.com/global/support/downloads/search/

Dimensions

(Unit: mm)

Outdoor Unit:

Single phase: WOHG112LHT/WOHG140LCTA

3-phase: WOHK112LCTA/WOHK140LCTA/WOHK160LCTA

Indoor Unit:

WGHG140DG

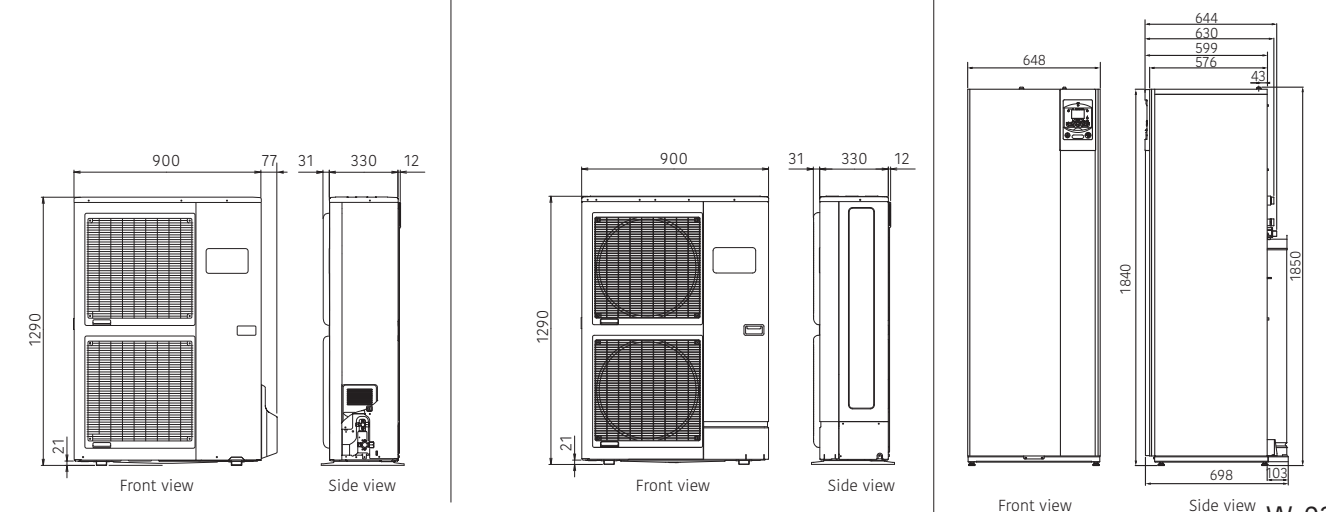

Split Type

Wall-Mounted type

Super High Power series



REFRIGERANT R410A

A++

A++

Max 60°C

High Water Flow Temperature

The temperature of water flow can be maintained at 60°C without using a backup heater, even when the outdoor temperature drops to -20°C. The system can supply 55°C water without a backup heater at an outdoor temperature of -22°C.

* If you want to raise the temperature of the water supply to above the maximum temperature, use a backup heater to supplement the primary heater.

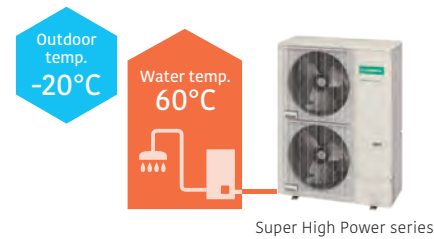

High COP

Heat pumps of ATW Systems work more efficiently and consume less energy than conventional heating systems.

Energy efficiency class

A++

Seasonal space heating energy efficiency (η_s)

Conditions: Outdoor Temp. 7°C Heating Temp. 35°C

163% (η_s)

COP 4.15

Single phase 16 kW class

Operating Range extended to -25°C

Operating range improved down to -25°C outdoor temperature



Indoor unit:
WSHG160DJ6

Outdoor unit:
WOHG160LJL



Specifications

Model Name	Indoor unit	Outdoor unit	WSHG160DJ6	WOHG160LJL	
Capacity range			16		
7°C/35°C floor heating *1	Heating capacity	kW	16.00		
	Input power		3.86		
	COP		4.15		
2°C/35°C floor heating *1	Heating capacity	kW	13.30		
	Input power		4.25		
	COP		3.13		
-7°C/35°C floor heating*1	Heating capacity	kW	14.50		
	Input power		5.27		
	COP		2.75		
-7°C/55°C Radiator*1	Heating capacity	kW	10.90		
	Input power		5.89		
	COP		1.85		
Space heating characteristics*2					
Temperature application	°C		55	35	
Energy efficiency class			A++	A++	
Rated heat output (P _{rated})	kW		14	16	
Seasonal space heating energy efficiency (η_s)	%		125	163	
Annual energy consumption	kWh		8,757	8,014	
Sound power level	Indoor unit	dB(A)	45	45	
	Outdoor unit		67	66	
Indoor unit specifications					
Power source	Single phase, ~230 V, 50 Hz				
Dimensions H × W × D	mm	805 × 450 × 471			
Weight (Net)	kg	52.5			
Water circulation	Min./Max.	L/min	26.4/57.8		
Buffer tank capacity	L	22			
Expansion vessel capacity	L	10			
Water flow temperature range	Max.	°C	60		
Water pipe connection diameter	Flow/Return	mm	Ø25.4/Ø25.4		
Electrical heater capacity	Heating	kW	6.0 (3.0 kW × 2 pcs.)		
Outdoor unit specifications					
Power source	Single phase, ~230 V, 50 Hz				
Current	Max.	A	28.0		
Dimensions H × W × D	mm	1,428 × 1,080 × 480			
Weight (Net)	kg	137			
Refrigerant	Type (Global Warming Potential)	R410A (2,088)			
	Charge	kg	3.80		
Additional refrigerant charge		g/m	50		
Connection pipe	Diameter	Liquid	mm	Ø9.52	
		Gas		Ø15.88	
	Length	Min./Max.	m	5/30	
	Length (Pre-charge)		m	15	
Height difference	Max.	m	25/15 (Outdoor unit: Upper/Lower)		
	Heating	°C	-25 to 35		

*1: Heating capacity, input power, and COP are measured using the EN14511 standard. Actual usage environments, such as the operating modes of the heating equipment, room temperature, and controller settings, may cause differences in values between those listed in the catalog and the actual performance characteristics.

*2: Information about ErP can be downloaded from our website at www.fujitsu-general.com/global/support/downloads/search/

Dimensions

(Unit: mm)

Outdoor Unit:
WOHG160LJL

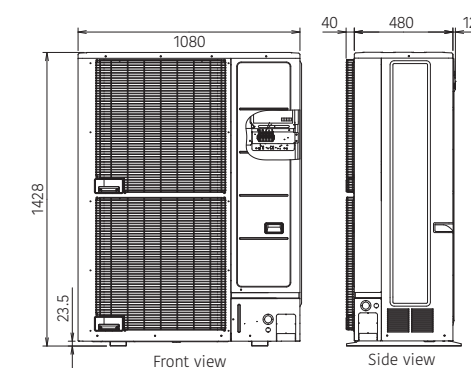

Indoor Unit:
WSHG160DJ6

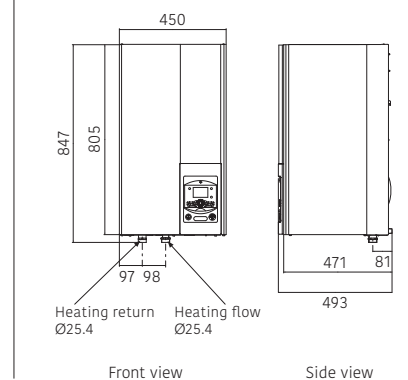

Split Type

DHW Integrated type
Super High Power series



High Water Flow Temperature

The temperature of water flow can be maintained at 60°C without using a backup heater, even when the outdoor temperature drops to -20°C. The system can supply 55°C water without a backup heater at an outdoor temperature of -22°C.

* If you want to raise the temperature of the water supply to above the maximum temperature, use a backup heater to supplement the primary heater.

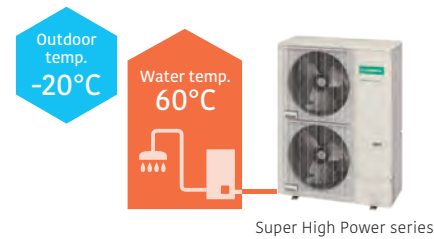

High COP

Heat pumps of ATW Systems work more efficiently and consume less energy than conventional heating systems.



Seasonal space heating energy efficiency (η_s)

Conditions: Outdoor Temp. 7°C Heating Temp. 35°C

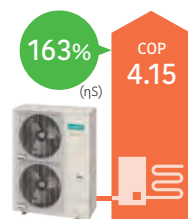

Single phase
16 kW class

Operating Range extended to -25°C

Operating range improved down to -25°C outdoor temperature

Stylish space saving solution with **Built-in High-performance DHW tank 190 L**

- Coil heat exchanger optimizes DHW supply performance.
- Temperature rises quickly due to the large surface of the exchanger.

Indoor unit:
WGHG160DJ6
Outdoor unit:
WOHG160LJL



Specifications

Model Name	Indoor unit	WGHG160DJ6	
Capacity range	Outdoor unit	WOHG160LJL	
Space heating characteristics*2			
Temperature application °C			
Energy efficiency class			
Rated heat output (P _{rated}) kW			
Seasonal space heating energy efficiency (η_s) %			
Annual energy consumption kWh			
Sound power level Indoor unit dB(A)			
Sound power level Outdoor unit dB(A)			
Domestic hot water characteristics*2			
Load profile			
Energy efficiency class			
Energy efficiency (n _{wh}) %			
Annual electricity consumption kWh			
Indoor unit specifications			
Power source			
Dimensions H × W × D mm			
Weight (Net) kg			
Water circulation Min./Max. L/min			
DHW tank volume L			
Electrical heater capacity Heating kW			
Electrical heater capacity DHW kW			
Buffer tank capacity L			
Expansion vessel capacity L			
Water flow temperature range Max. °C			
Water pipe connection diameter Flow/Return mm			
Hot water pipe connection diameter mm			
Outdoor unit specifications			
Power source			
Current Max. A			
Dimensions H × W × D mm			
Weight (Net) kg			
Refrigerant Type (Global Warming Potential)			
Refrigerant Charge kg			
Additional refrigerant charge g/m			
Connection pipe Diameter Liquid mm			
Connection pipe Diameter Gas mm			
Connection pipe Length Min./Max. m			
Connection pipe Length (Pre-charge) m			
Connection pipe Height difference Max. m			
Operating range Heating °C			

*1: Heating capacity, input power, and COP are measured using the EN14511 standard. Actual usage environments, such as the operating modes of the heating equipment, room temperature, and controller settings, may cause differences in values between those listed in the catalog and the actual performance characteristics.
*2: Information about ErP can be downloaded from our website at www.fujitsu-general.com/global/support/downloads/search/

Dimensions

(Unit: mm)

Outdoor Unit:
WOHG160LJL

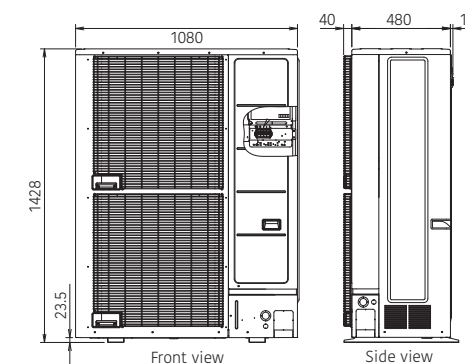

Indoor Unit:
WGHG160DJ6

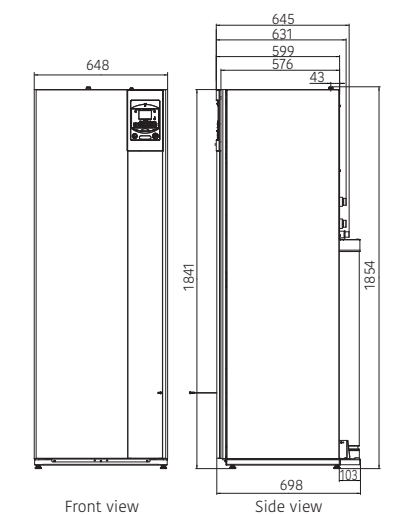



Indoor Unit

Type-A
Type-B

Selecting the indoor unit

- This is a device for storing hot water and circulating it to housing equipment.
- Selection criteria for the indoor unit is which housing equipment it will be connected to, such as a radiator or shower.
- Indoor unit you choose will also depend on whether you already own devices such as a pump or tank.



Radiator, Fan coil



Shower, Bath



Under floor heating

Domestic hot water



What Each Indoor Unit Can Do



Indoor unit control box*

If you want to update your system by reusing your existing pump and buffer tank, etc., you can do so by installing only the control box.



Indoor unit Wall-mounted

Stands for preparation of heating water for under floor heating and radiators. It can optionally operate with domestic hot water tank.



Indoor unit Domestic Hot Water (DHW) integrated

Can be used with a variety of heating systems, including under floor heating and radiators. Space saving heating and DHW supply in a single indoor unit.

*The control box can only be selected for Monobloc outdoor unit.

Types of Indoor Units



Compatibility for Monobloc type Comfort series



Indoor unit type	Control box	Wall-mounted	DHW integrated
Housing Equipment			
Under floor heating	○	●	●
Radiator	○	●	●
Fan coil	○	●	●
Bath	○	○	●
Shower	○	○	●
Hot Water	○	○	●



Compatibility for Split type Comfort series, High power series Super high power series



Indoor unit type	Wall-mounted	DHW integrated
Housing Equipment		
Under floor heating	●	●
Radiator	●	●
Fan coil	●	●
Bath	○	●
Shower	○	●
Hot water	○	●

● : It can be used by constructing a system using options and carrying out water pipe work.

○ : It can be used by constructing a system using options and carrying out water pipe work, by reusing (or locally procuring) existing pumps and tanks, etc.

Housing Equipment requires the preparation of separately sold products.

Type-A

Comfort Control

Useful Features

Flow temperature control with climate compensation

Automatic Heating Curve Control

Automatic temperature regulation according to heating curve (depending on heating terminal and outdoor temperature)

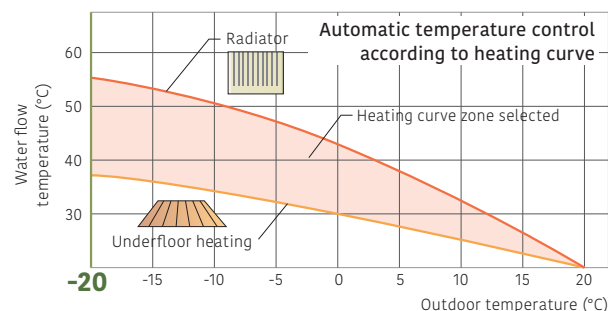

Auto Changeover

When Auto mode is selected, the system automatically switches between cooling and heating modes depending on the outdoor temperature to serve as an all-season air conditioner.

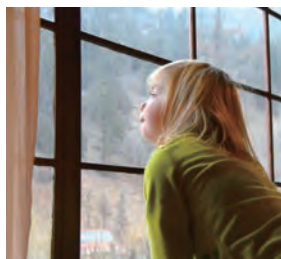

Quick Recovery from Defrosting

Maintains room temperature by boost start operation during defrosting.

2-zone Independent Control

2-zone independent control (For example, the individual control of 2 underfloor heating zones or the combination of 1 underfloor heating zone and 1 radiator zone)**2

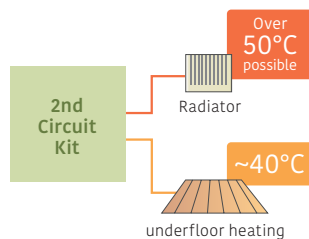

*1: Optional parts such as 2-zone kits, 3-zone kits, and thermostats are required
*2: 3 Zones can be controlled in the Control Box

Backup Heater Operation

Backup heater maintains a comfortable room temperature even when the outside temperature is low. The backup heater is intelligently controlled as a safety backup for very cold days and nights, and only operates when really needed.

Controller with a clear color display and simple icons for easy function settings

Color display

Shows all the information items related to the operation mode:
WLAN Connectivity / Operation / Pressure / Set temperature (DHW / Flow) / Clock / Message / Service maintenance



- Operation indicator
Fixed white: Normal operation
Flashing orange: Error
- Menu access button
- Navigation knob:
Rotation: Menu navigation
Press: Validation
- Back button

Main operation flow and settings for installers and end users

	Flow Chart	Example Item
Installers	1 Install Settings	Pump speed setting, Configuration, Heating curve setting, Heat pump shut off
	2 Option Settings	Cooling Kit, DHW Kit, Boiler Kit
	3 Convenient Function	Automatic heating curve settings, Underfloor controlled driving, Outdoor temperature adjustment, Maintenance period settings
	4 Workout Settings	Outdoor temperature simulator
	5 Confirmation	Checking operation (Heating and cooling, DHW, option)
End users	6 User Settings	Date and time, Time program, Operation temperature settings

Energy Saving

Away mode

It will set heating and DHW mode to the frost protection* during the selected period:

- If you activate away mode on HMI: You can choose start and end time/date.
- If you activate away mode on Room thermostat (option): You can choose start and end time/date, as well as room setpoint during away period.

*: The protection mode automatically prevents an excessively sharp drop in room temperature.

Safety Features

Anti-freeze function

When the outside temperature drops below a specified level, the outdoor unit water pump will self-activate and water will also be automatically circulated to prevent freezing.

Easy Installation & Maintenance

- All hydraulic safety and control components are built in with no additional selection required.
- Easy access for maintenance
- Refrigerant pump down operation

Error and Maintenance Alarm

Enables quick error-handling services and maintenance



Maintenance Support

Diagnostics functions for troubleshooting



Easy to Set Up

Easy Start
Choose language, set date and time. Answer questions from Easy Start.

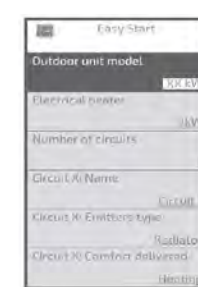

Remote Connectivity and Control

Via app "Cozy touch", you can manage and control of electric heaters, electric water heaters, heat pump water heaters, heat pumps.
* Cozytouch is a service of Group Atlantic



Type-A

Optional Parts & Control Overview

To meet the diverse needs of customers, we offer a variety of control options, such as individual control and remote control options.

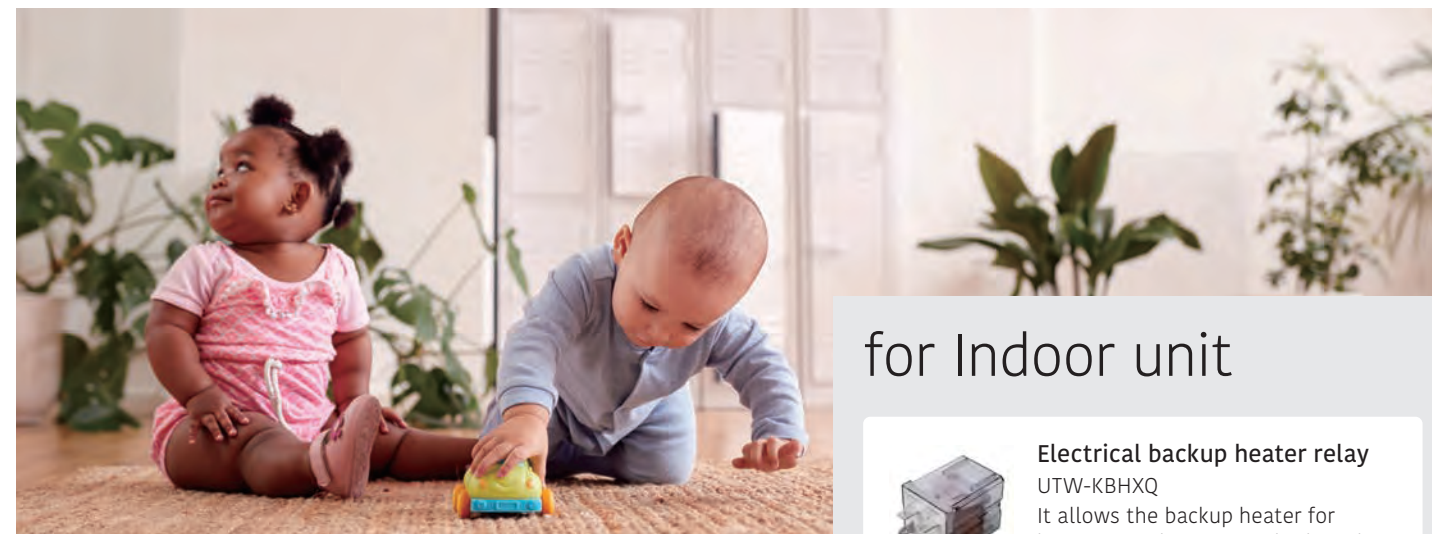

for Indoor unit



Electrical backup heater relay
UTW-KBHXQ
It allows the backup heater for heating at 3 kW as standard can be used at 6 kW.

for Locally units



Second Circuit Kit
UTW-KZSXQ
It can supply hot water at different temperatures to each two types of heating equipment, such as radiators and underfloor heating.



UTW-KZC2XQ

UTW-KZDXQ

Boiler Connection Kit

It can build hybrid systems using both boilers and heat pumps. Boiler and heat pumps are switched according to outside air temperature.



UTW-KBCXQ

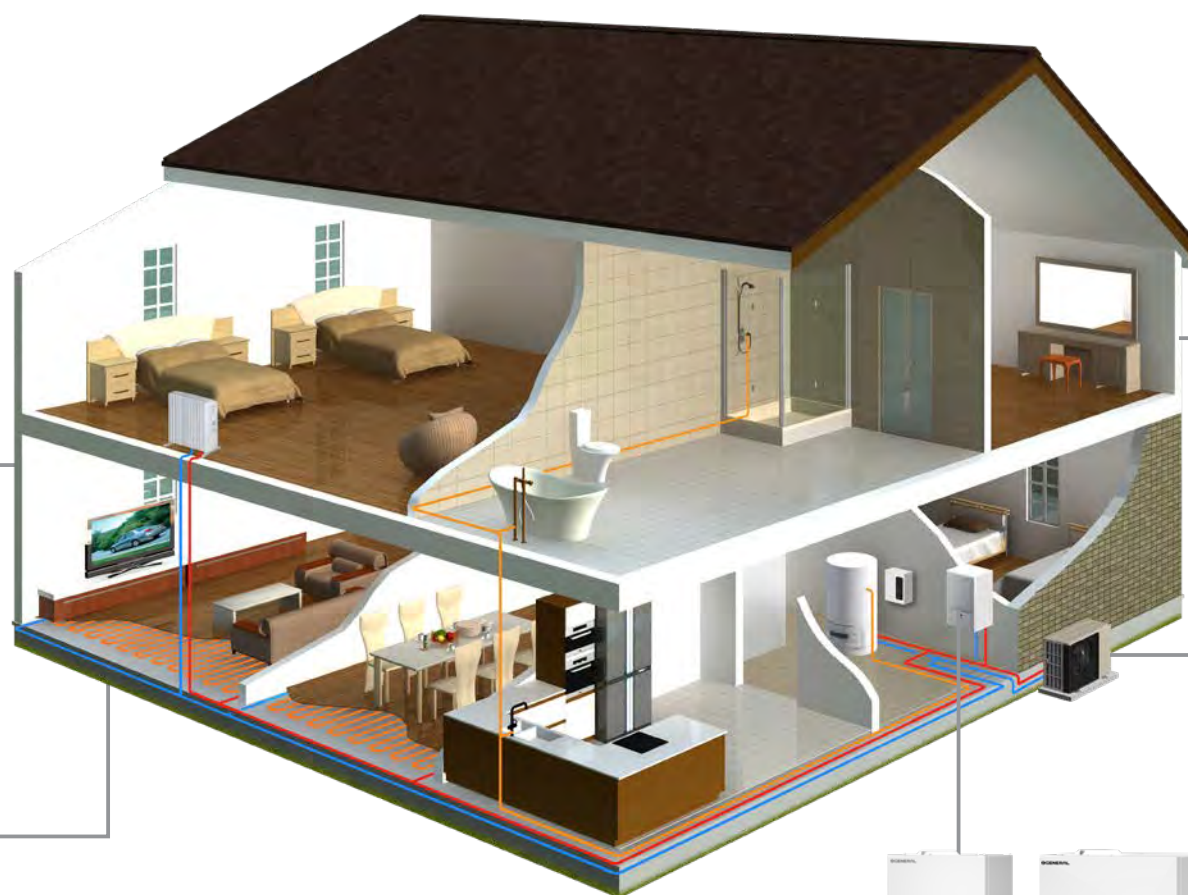

for Outdoor unit



Drain pan
UTW-KDPXQ
It is used to collect and drain condensation water generated by outdoor unit.



Antivibration Rubber feet
UTW-KARXQ
It reduces vibration caused by the operation of compressors and other equipment, and suppresses the generation of noise.



Antifreezing valve for Monobloc
UTW-KAVXQ
When water pipes freeze, the internal pressure increases and the pipes are purged to prevent parts from breaking.

for DHW



DHW Kit
Required to connect locally purchased DHW tanks to Air to Water.

UTW-KDWXQ

UTW-KDWCXQ



DHW tank
200 Liters: UTW-T20AXH / UTW-T20BXH
300 Liters: UTW-T30AXH / UTW-T30BXH
The BXH series is a more efficient tank than the AXH series.



DHW Expansion Kit
UTW-KDEXQ
The expansion vessel(18L) for connection to DHW water pipe.

Service & Maintenance Tool

Service Monitor Tool
UTY-ASSXZ1



Wall-mounted



Indoor unit Controller



DHW Integrated

Monobloc type Comfort series

Individual Control

Room thermostat
An optional wireless thermostat allows remote control of the ATW system away from the indoor unit. Can also be operated from mobile apps.



Wired power supply
UTW-C225XQ



























Battery power supply
UTW-C228XQ

Cozy tough (Application)
* Cozytouch is a service of Group Atlantic



Type-A Optional Parts List

Product Name	Model Name	Monobloc Type			
		Comfort series			
		10			
		Contoll Box	Wall-mounted	DHW Integrated	Outdoor Unit
Second Circuit Kit 	UTW-KZSXQ		•*		
DHW Kit 	UTW-KDWXQ		•		
Second Circuit Kit 	UTW-KZDXQ			•*	
DHW Loop Kit 	UTW-KDLXQ			•	
DHW Expansion Kit 	UTW-KDEXQ			•	
Outdoor temperature sensor 	UTW-KESXQ	•	•	•	
Condensation detection sensor 	UTW-KCDXQ	•	•	•	
Regulation Extension Kit 	UTW-KREXQ	•	•	•	
Electrical Backup heater relay 	UTW-KBHXQ		•	•	
Wired power supply 	UTW-C225XQ	•	•	•	
Battery power supply 	UTW-C228XQ	•	•	•	
Cover Plate for thermostat 	UTW-KCPXQ	•	•	•	
Drain pan 	UTW-KDPXQ				•
Antivibration Rubber feet 	UTW-KARXQ				•
Antifreezing valve for Monobloc 	UTW-KAVXQ				•

Product Name	Model Name	Monobloc Type			
		Comfort series			
		10			
		Contoll Box	Wall-mounted	DHW Integrated	Outdoor Unit
Single Circuit Kit 	UTW-KZC1XQ	•			
Second Circuit Kit 	UTW-KZC2XQ	•			
Third Circuit Kit 	UTW-KZC3XQ	•			
Third Circuit Kit 	UTW-KZC3XQ	•			
Third Circuit Kit 	UTW-KZC3XQ	•			
Third Circuit Kit 	UTW-KZC3XQ	•			
Boiler Connection Kit 	UTW-KBCXQ	•			
DHW Kit 	UTW-KDWCXQ	•			
Backup Heater Kit 	UTW-HB6CXQ	•			
DHW tank	UTW-T20AXH UTW-T30AXH	•	•		
DHW tank	UTW-T20BXH UTW-T30BXH	•	•		

*1: Regulation extension kit (UTW-KREXQ) is not included but is required for connection.

Type-**B**

Comfort Control

The high-grade heating controller automatically adjusts the flow temperature according to the climate conditions to maintain the room and domestic hot water temperatures at the desired levels.

Indoor unit Controller

4 Heating modes

1. Automatic mode

Enables automatic switching between Comfort mode and Reduce mode according to time program

2. Reduce mode

Maintains water temperature at a lower level

3. Comfort mode

Maintains water temperature at a comfortable level

4. Protection mode

Activates frost protection in standby operation



Useful Features

Automatic Heating Curve Control

Automatic temperature regulation according to heating curve (depending on heating terminal and outdoor temperature)

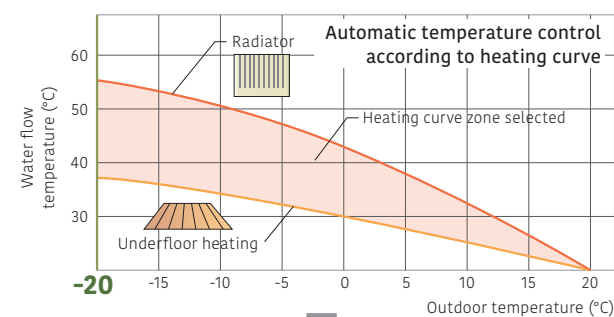

The heating curve will shift to adjust the room temperature setting.

Can be fine-adjusted when it is too warm or too cold.

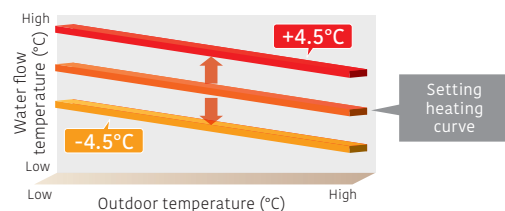

Quick Recovery from Defrosting

Maintains room temperature by boost start operation during defrosting.

Auto Changeover

When cooling mode is selected, the system automatically switches between cooling and heating modes depending on the outdoor temperature to serve as an all-season air conditioner.

2-Zone Independent Control

2-zone independent control (For example, the individual control of 2 underfloor heating zones or the combination of 1 underfloor heating zone and 1 radiator zone)*1

*1: Optional parts required

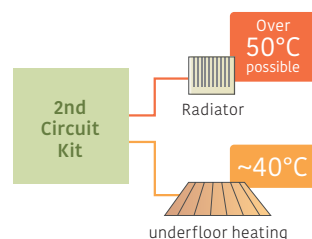

2-Stage Low-Noise Mode

The outdoor unit can be switched to quiet mode, depending on the installation environment.

*Effective only for high power series

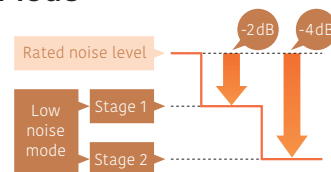

Backup Heater Operation

Backup heater maintains a comfortable room temperature even when the outside temperature is low. The backup heater is intelligently controlled as a safety backup for very cold days and nights, and only operates when really needed.

* Optional parts is needed for high power series.

Energy Saving

Time Program

- The timer is easy to set.
- You can select the heating mode in conjunction with various times of the day.

Day-weekly timer

- Allows up to 3 settings per day.
- Allows individual settings for each day of the week.

Holiday timer

- Allows up to 8 settings.
- While you are away from home for an extended period during winter, the system prevents your room or house from freezing.

Peak Cut Function*2

Sets the peak current value to reduce power consumption.

Mode	Ratio to reduce power consumption
1	100%
2	75%
3	50%
4	Almost 0%

* Please refer to page W-054 and W-055 for optional parts information.

Safety Features

Anti-Legionella Function

Prevents the growth of Legionella bacteria in the DHW tank to supply safe and clean hot water at all times.

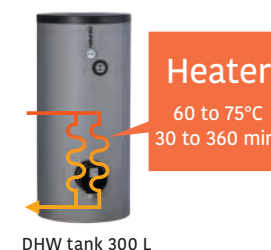

Anti-Freeze Function

When the outside temperature drops below a specified level, the compressor will self-activate and water will also be automatically circulated to prevent freezing.

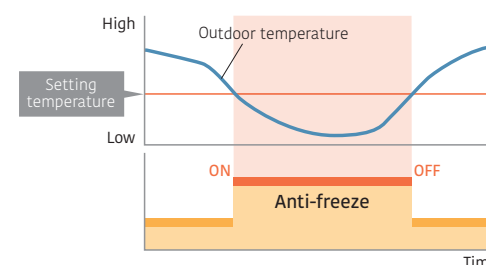

Emergency Operation

If an outdoor unit fails to operate, a built-in backup heater or an external boiler is activated to supply an uninterrupted supply of hot water to the house.

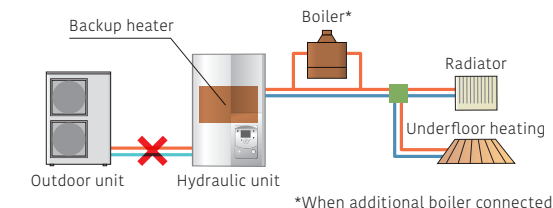

Error and Maintenance Alarm

Enables quick error-handling services and maintenance



- Error history saves 10 errors in memory
- Display telephone number of service company

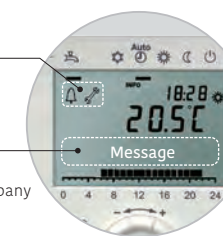

Type-**B**

Simple Installation

Presetting Configurations

A controller installed makes it easy to configure the system without having to set each component or unit individually.

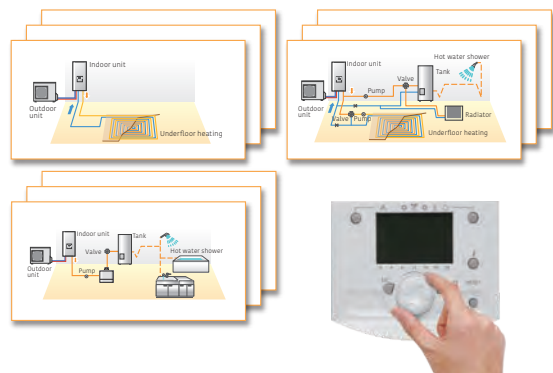

8 simple patterns for system presetting (Pair of heating: 12 patterns)

Configuration (Parameter 5700)	Installation type
Presetting 1	1 heating circuit
Presetting 2	2 heating circuits
Presetting 3	1 heating circuit with boiler backup
Presetting 4	2 heating circuits with boiler backup
Presetting 5	1/2 heating circuit with buffer control
Presetting 6	1/2 heating circuit with buffer control and boiler backup
Presetting 7	Cascade connection Primary
Presetting 8	Cascade connection A
Presetting 9	Cascade connection B/C

- DHW & solar control auto detection
- Cascade connection only available in High Power models.

Outdoor Temperature Simulation

It verifies that each unit operates properly under the set conditions and expected outdoor air temperature when the system is actually assembled.

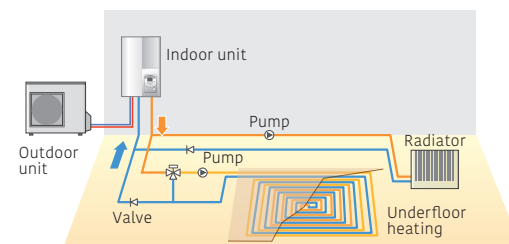

The outdoor temperatures can be simulated in the range of -50°C to +50°C.

Concrete Floor Drying

Allows the concrete surrounding the hot-water pipes to dry more quickly, shortening the construction period for underfloor heating installations.

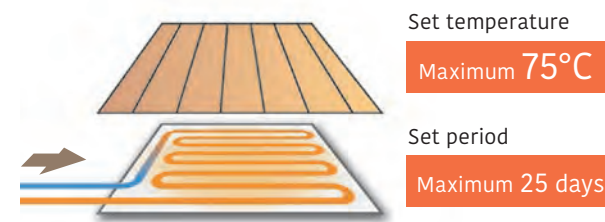

Controller with a large liquid crystal display and buttons for easy function settings

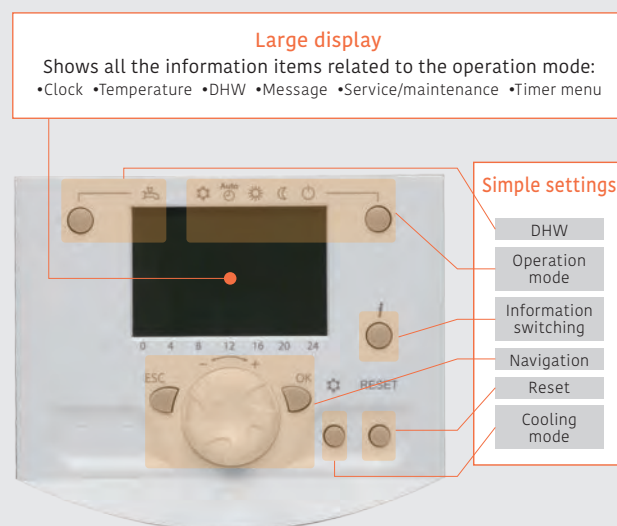

Main operation flow and settings for installers and end users

	Flow Chart	Example Item
Installers	1 Install Settings	Pump speed setting, Configuration, Heating curve setting, Heat pump shut off
	2 Option Settings	Cooling Kit, DHW Kit, Boiler Kit
	3 Convenent Function	Automatic heating curve settings, Underfloor controlled driving, Outdoor temperature adjustment, Maintenance period settings
	4 Workout Settings	Outdoor temperature simulator
	5 Confirmation	Checking operation (Heating and cooling, DHW, option)
End users	6 User Settings	Date and time, Time program, Operation temperature settings

Easy Installation & Maintenance

- All hydraulic safety and control components are built in with no additional selection required.
- Lifting bars for installation free of difficulty or risk
- Easy access for maintenance
- Refrigerant pump down operation

Maintenance Support

Diagnostics functions for troubleshooting

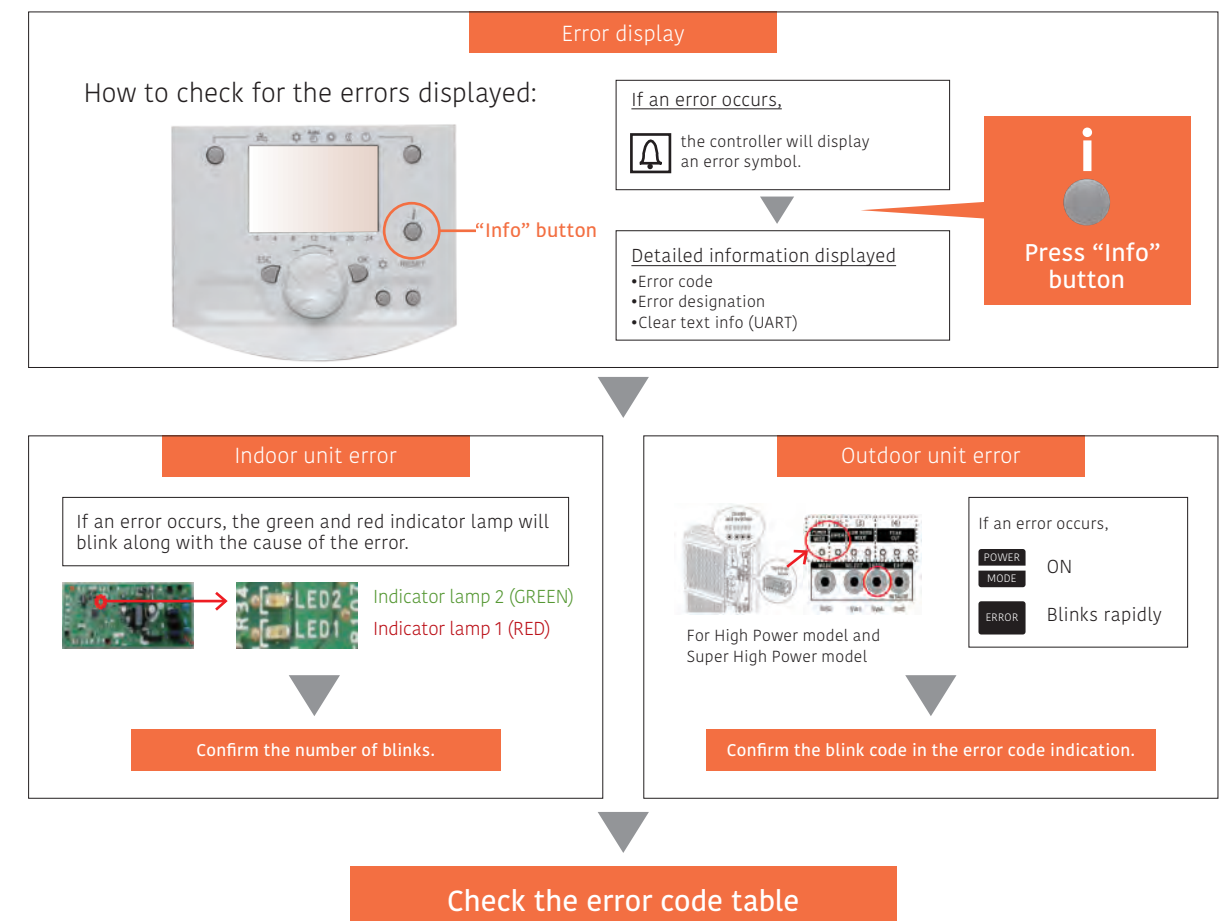

Type-**B**

Control Overview

To meet the diverse needs of customers, we offer a variety of control options, such as individual control and remote control options.

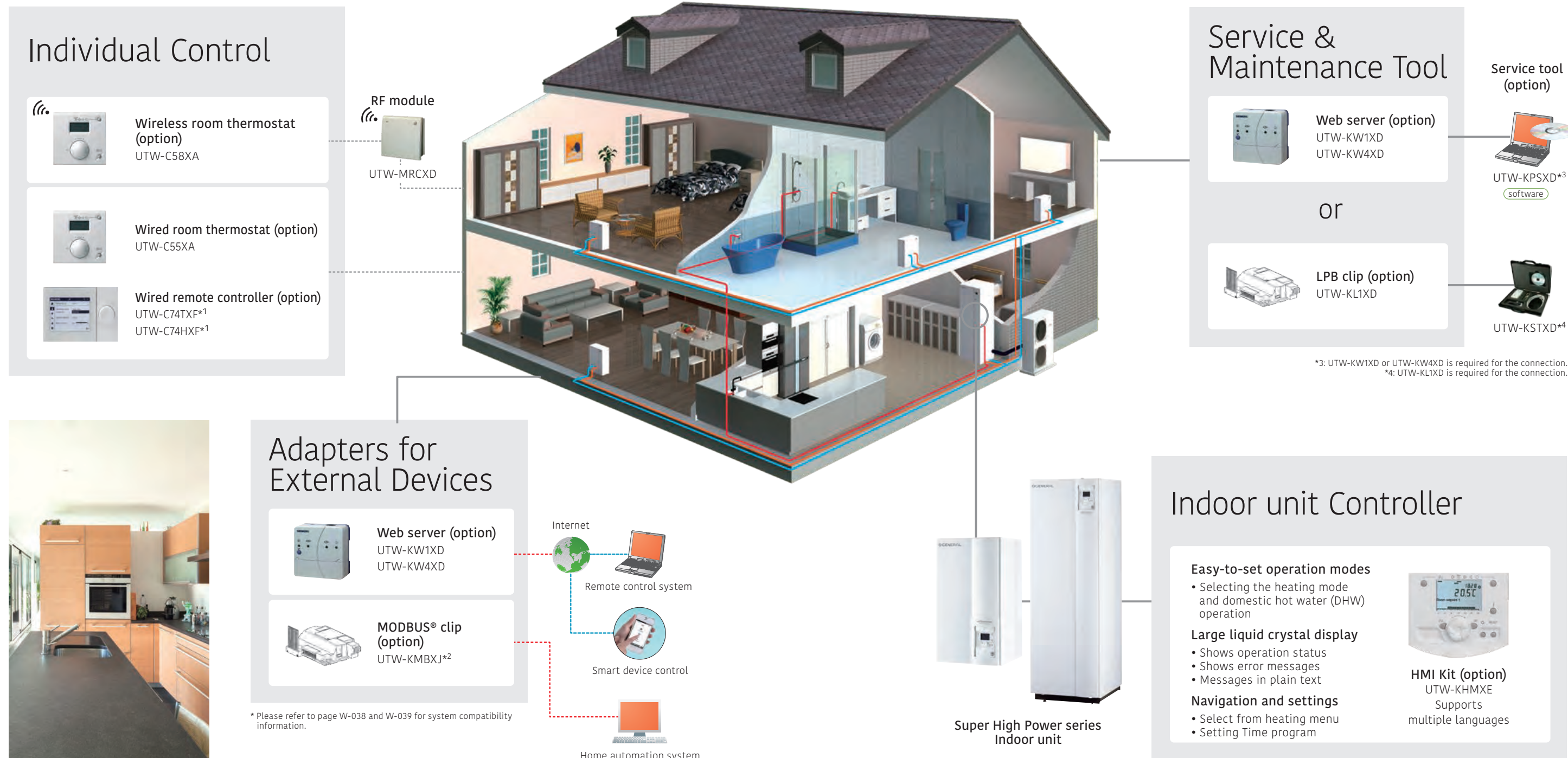

Type-**B**

Optional Parts Overview

Various optional parts are available to use ATW according to needs and environments.



for Locally units



UTW-KZSXE*1

Second Circuit Kit

It can supply hot water at different temperatures to each two types of heating equipment, such as radiators and underfloor heating.



UTW-KZDXE*1



UTW-KZSXJ



UTW-KZDXJ

Boiler Connection Kit

It can build hybrid systems using both boilers and heat pumps. Boiler and heat pumps are switched according to outside air temperature.



UTW-KBSXD



UTW-KBDXD



UTW-KBSXJ

*1: The UTW-KREXD (Regulation Extension Kit) is not included but is required for connection.



for Indoor unit



Circulating pump

UTW-PHFYG

The high-output pump for replacement of the standard pump in the hydraulic unit. It can be used in properties with longer and more complex water pipe.

Cascade Master/Slave Kit

Up to 3 indoor units can be connected for large-capacity use. It is need to install a primary kit in one unit and a secondary kit in one or two other units.



Cascade Master Kit (incl. LPB clip)



Cascade Slave Kit (incl. LPB clip)

Cooling Kit

Required when using ATW also for cooling operation. It is used to prevent condensation occurring in the indoor unit.



UTW-KCLXD



UTW-KCLXL

for Outdoor unit



Drain pan

UTW-KDPXB

It is used to collect and drain condensation water generated by outdoor unit.



External Connection Kit

UTY-XWZXZ2 / UTY-XWZXZ3

The signal input (low noise mode, peak cut) and signal output (compressor operation, base pan heater control) for outdoor unit are possible externally.

for DHW



DHW Kit

UTW-KDWXD (External)

Required to connect locally purchased DHW tanks to Air to Water.



DHW tank

200 Liters: UTW-T20AXH / UTW-T20BXH

300 Liters: UTW-T30AXH / UTW-T30BXH

The BXH series is a more efficient tank than the AXH series.

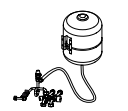

UTW-KDEXE



UTW-KDEXL

DHW Expansion Kit

The expansion vessel(18L) for connection to DHW water pipe.



