

Light Commercial & Residential MULTI-SPLIT

- M-002 Multi-Split Overview
- M-004 Multi-Split Outdoor Units Lineup
- M-006 2-unit to 3-unit Multi-Split (Eco range) Connectable Indoor Units
- M-008 2-unit to 5-unit Multi-Split Connectable Indoor Units
- M-012 6-unit Multi-Split Connectable Indoor Units
- M-014 Simultaneous Multi-Split Connectable Indoor Units
- M-062 Feature Summary



Refrigerant type R32 Models

- M-016 2-unit,3-unit,Multi-Split (Eco range)
-
- M-018 2-unit to 3-unit Multi-Split (Eco range)
Indoor Units Specifications
-
- M-020 2-unit to 5-unit Multi-Split
- M-026 Simultaneous Multi-Split Twin/Triple
-
- M-030 2-unit to 5-unit Multi-Split Indoor Units Specifications
-
- M-036 2-unit to 3-unit Multi-Split (Eco range) Combination Table
- M-040 2-unit to 5-unit Multi-Split Combination Table



Refrigerant type R410A Models

- M-024 6-unit Multi-Split
- M-028 Simultaneous Multi-Split Twin/Triple/Double Twin
-
- M-034 6-unit Multi-Split Indoor Units Specifications
-
- M-056 6-unit Multi-Split Combination Table



A single outdoor unit drives multiple indoor units, offering greater flexibility in system configuration.

If you wish to keep an entire floor or two or more rooms comfortable, we recommend you choose a multi-split air conditioning system with a single outdoor unit. Choose one that meets your air conditioning requirements from the variety of models we offer. You can mix and match indoor and outdoor units as you wish to build the system that best suits your needs.



Multi-Split Overview

Multi-split's space-saving outdoor unit allows for connections of up to eight indoor units for multiple rooms. Added to the lineup are models compatible with the R32 refrigerant, offering environmentally friendly comfort in homes, offices, stores, and various other settings.



3-unit, 4-unit, 5-unit Multi-split Types



2-unit Multi-split



2-unit to 6-unit Multi-split

Recommended for residences, offices, and other situations where multiple rooms require air conditioning. Each of the 2 to 6 connected indoor units can also be operated individually. Operation control, time scheduling for each room, and energy-saving options can be set on both individual and central remote controllers. The outdoor unit is designed to save space and is flexible enough to be installed on a balcony or underneath a waist-high window.

6-unit Multi-split



Twin / Triple



Twin / Triple / Double Twin



Twin / Triple / Double Twin



NEW

2-unit to 3-unit Multi-split Eco range model

Multi-split systems for 2 and 3 rooms are ideal for environments requiring air conditioning in multiple rooms, such as homes and offices, delivering energy-saving performance. Connectable indoor units come standard with WLAN, enabling individual operation via an app. The outdoor unit features a space-saving design, allowing flexible installation on balconies or beneath windows up to waist height.

2-unit Multi-split

3-unit Multi-split



Simultaneous Multi-split Type

Suitable for a small building, the entrance hall of a small office, meeting rooms, educational facilities, and other roomy areas where multiple indoor units need to be operated simultaneously. Up to 4 indoor units can be operated simultaneously, making the system perfect for air conditioning not only offices with large spaces, but also spaces with atypical layouts.



Multi-Split Outdoor Units Lineup



GENERAL HVAC Solutions Euro GmbH participates in the ECP program for AC. Check ongoing validity of certificate: www.eurovent-certification.com
*Models so marked are not ECC certified.

		Class		14		18		18		24		30		36		45		54		72		90				
		Cooling rated capacity (kW)		4.0		5.0		5.4		6.8		8.0		10.0		12.5		14.0		14.0		19.0		22.0		
Eco Range	NEW 2-unit, 3-unit, Multi-split (Eco range)	2-unit Multi-split Up to 2 units	R32		AOHH14KACB2	AOHH18KACB2																				
		3-unit Multi-split Up to 3 units				AOHH18KACB3																				
Standard Range	2-unit, 3-unit, 4-unit, 5-unit Multi-split	2-unit Multi-split Up to 2 units	R32		AOHG14KBTA2	AOHG18KBTA2																				
		3-unit Multi-split Up to 3 units				AOHG18KBTA3		AOHG24KBTA3																		
		4-unit Multi-split Up to 4 units							AOHG30KBTA4																	
		5-unit Multi-split Up to 5 units									AOHG36KBTA5*1															
	6-unit Multi-split	6-unit Multi-split Up to 6 units	R410A											AOHG45LBA6*												
	Simultaneous Multi-split	Twin Single-phase 3-phase	R32										AOHG36KBTB AOHG36KRTA		AOHG45KBTB AOHG45KRTA											
		Twin/Triple Single-phase 3-phase																AOHG54KBTB AOHG54KRTA								
		NEW Twin/Triple/ Double Twin 3-phase																				AOHH72KRTA		AOHH90KRTA		
Twin/Triple/ Double Twin 3-phase		R410A																				AOHG72LRLA		AOHG90LRLA		

Notes:
1. 2-unit Multi-split:
 Connectable indoor units are 2 units.
 AOHG14KBTA2: Total capacity of indoor units connected must be between 10000Btu/h and 21000Btu/h.
 AOHH14KACB2: Total capacity of indoor units connected must be between 14000Btu/h and 21000Btu/h.
 AOHG18KBTA2: Total capacity of indoor units connected must be between 10000Btu/h and 26000Btu/h.
 AOHH18KACB2: Total capacity of indoor units connected must be between 14000Btu/h and 24000Btu/h.

2. 3-unit Multi-split:
 Connectable indoor units are 2 to 3 units.
 AOHG18KBTA3: Total capacity of indoor units connected must be between 14000Btu/h and 30000Btu/h.
 AOHG24KBTA3: Total capacity of indoor units connected must be between 14000Btu/h and 36000Btu/h.
 AOHH18KACB3: Total capacity of indoor units connected must be between 14000Btu/h and 30000Btu/h.

3. 4-unit Multi-split:
 Connectable indoor units are 2 to 4 units.
 AOHG30KBTA4: Total capacity of indoor units connected must be between 27000Btu/h and 48000Btu/h.

4. 5-unit Multi-split:
 Connectable indoor units are 2 to 5 units.
 AOHG36KBTA5: Total capacity of indoor units connected must be between 27000Btu/h and 54000Btu/h.





5. 6-unit Multi-split:
 Connectable indoor units are 2 to 6 units.
 AOHG45LBA6: Total capacity of indoor units connected must be between 36000Btu/h and 60000Btu/h.

*For compatible Outdoor Units with 5,000BTU models, please refer to the Design & Technical Manual Part. 1-1

Cooling rated capacity: *1: 9.5 kW

2-unit to 3-unit Multi-Split (Eco range) Connectable Indoor Units



Type		2-unit		3-unit
Model name		AOHH14KACB2	AOHH18KACB2	AOHH18KACB3
Multi-split Type Outdoor Unit				
Capacity (kW)				
		Cooling	4.0	5.0
		Heating	4.2	5.3
				5.3
				6.4
Indoor Unit	BTU	kW Class		
 ASHH07/09/12KLTBL	7,000	2.0	●	●
	9,000	2.5	●	●
	12,000	3.5	●	●





2-unit to 5-unit Multi-Split Connectable Indoor Units



Type		2-unit		3-unit		4-unit	5-unit					
Model name		AOHG14KBTA2	AOHG18KBTA2	AOHG18KBTA3	AOHG24KBTA3	AOHG30KBTA4	AOHG36KBTA5					
Multi-split Type Outdoor Unit												
Capacity (kW)		Cooling	Heating	Cooling	Heating	Cooling	Heating					
		4.0	4.4	5.0	5.6	5.4	6.8	6.8	8.0	9.6	9.5	10.6
Indoor Unit	BTU	kW Class	2-unit		3-unit		4-unit	5-unit				
NEW ASHH 05/07/09/12/14KJCAL ASHH 05/07/09/12/14KJCA ASHH 05/07/09/12/14KJCALB ASHH 05/07/09/12/14KJCA-B	5,000	1.5	●*	●*	●*	●*	●*	●*				
	7,000	2.0	●	●	●	●	●	●				
	9,000	2.5	●	●	●	●	●	●				
	12,000	3.5	●	●	●	●	●	●				
	14,000	4.0	—	●	●	●	●	●				
 ASHH07/09/12/14KMCG ASHG07/09/12/14KMCF ASHH07/09/12/14KMCG-B	7,000	2.0	●	●	●	●	●	●				
	9,000	2.5	●	●	●	●	●	●				
	12,000	3.5	●	●	●	●	●	●				
	14,000	4.0	—	●	●	●	●	●				
 ASHH05/07/09/12KNCA	5,000	1.5	●*	●*	●*	●*	●*	●*				
	7,000	2.0	●	●	●	●	●	●				
	9,000	2.5	●	●	●	●	●	●				
	12,000	3.5	●	●	●	●	●	●				
NEW ASHH18/22/24KMTGL	18,000	5.0	—	—	—	●	●	●				
	22,000	6.0	—	—	—	—	●	●				
	24,000	7.0	—	—	—	—	●	●				
 AGHG09/12/14KVCA	9,000	2.5	●	●	●	●	●	●				
	12,000	3.5	●	●	●	●	●	●				
	14,000	4.0	—	●	●	●	●	●				

*For compatible Outer Units with 5,000BTU models, please refer to the Design & Technical Manual Part. 1-1



2-unit to 5-unit Multi-Split Connectable Indoor Units



Type	2-unit		3-unit		4-unit	5-unit	
Model name	AOHG14KBTA2	AOHG18KBTA2	AOHG18KBTA3	AOHG24KBTA3	AOHG30KBTA4	AOHG36KBTA5	
Multi-split Type Outdoor Unit							
Capacity (kW)	Cooling	4.0	5.0	5.4	6.8	8.0	9.5
	Heating	4.4	5.6	6.8	8.0	9.6	10.6

Indoor Unit	BTU	kW Class	2-unit					3-unit		4-unit	5-unit
			AOHG14KBTA2	AOHG18KBTA2	AOHG18KBTA3	AOHG24KBTA3	AOHG30KBTA4	AOHG36KBTA5			
 AUXG07/09/12/14/18/22KVLA	7,000	2.0	●	●		●	●	●	●		
	9,000	2.5	●	●		●	●	●	●		
	12,000	3.5	●	●		●	●	●	●		
	14,000	4.0	—	●		●	●	●	●		
	18,000	5.0	—	—		—	●	●	●		
	22,000	6.0	—	—		—	—	●	●		
 ARXG07/09/12/14/18KSLAP	7,000	2.0	●	●		●	—	●	●		
	9,000	2.5	●	●		●	●	●	●		
	12,000	3.5	●	●		●	●	●	●		
	14,000	4.0	—	●		●	●	●	●		
	18,000	5.0	—	—		—	●	●	●		
 ARXG07/09/12/14/18KLLAP	7,000	2.0	●	●		●	●	●	●		
	9,000	2.5	●	●		●	●	●	●		
	12,000	3.5	●	●		●	●	●	●		
	14,000	4.0	—	●		●	●	●	●		
	18,000	5.0	—	—		—	●	●	●		
 ARXH12/14/18/22KMTAP	12,000	3.5	●	●		●	●	●	●		
	14,000	4.0	—	●		●	●	●	●		
	18,000	5.0	—	—		—	●	●	●		
	22,000	6.0	—	—		—	—	●	●		
 ARXG22KMLB	22,000	6.0	—	—		—	—	●	●		
 ABHG18/22KRTA	18,000	5.0	—	—		—	●	●	●		
	22,000	6.0	—	—		—	—	●	●		

6-unit Multi-Split Connectable Indoor Units



Type	6-unit	
Model name	AOHG45LBA6	
Multi-split Type Outdoor Unit		
Capacity (kW)	Cooling	12.5
	Heating	13.5

Indoor Unit	BTU	kW Class	
 ASHG07/09/12/14LMCA	7,000	2.0	●
	9,000	2.5	●
 ASHG07/09/12/14LUCA	12,000	3.5	●
	14,000	4.0	●
 ASHG18/24LF	18,000	5.0	●
	24,000	7.0	●
 AGHG09/12/14LV	9,000	2.5	●
	12,000	3.5	●
	14,000	4.0	●
 AUHG07/09/12/14/18LV	7,000	2.0	●
	9,000	2.5	●
	12,000	3.5	●
	14,000	4.0	●
 ABHG14LVTA ABHG18LVTB	14,000	4.0	●
	18,000	5.0	●
 ARHG07/09/12/14/18LSLAP	7,000	2.0	●
	9,000	2.5	●
	12,000	3.5	●
	14,000	4.0	●
 ARHG07/09/12/14/18LL	18,000	5.0	●
	7,000	2.0	●
	9,000	2.5	●
	12,000	3.5	●
 ARHG07/09/12/14/18LL	14,000	4.0	●
	18,000	5.0	●







Simultaneous Multi-Split Connectable Indoor Units





Type		4HP	5HP	6HP
Model name	Single	AOHG36KBTB	AOHG45KBTB	AOHG54KBTB
	3-phase	AOHG36KRTA	AOHG45KRTA	AOHG54KRTA
Simultaneous Multi-split Type Outdoor Unit				
Capacity (kW)	Cooling	9.5	12.1	13.4
	Heating	10.8	13.5	15.5

Indoor Unit	BTU	kW Class	Twin			Triple
 AUXG18/22/24KVLA	18,000	5.0	● × 2	—	—	● × 3
	22,000	6.5	—	● × 2	—	—
	24,000	7.0	—	—	● × 2	—
 ARXG18KLLAP	18,000	5.0	● × 2	—	—	● × 3
	22,000	6.5	—	● × 2	—	—
 ARXG22KMLB ARXG24KMLA	24,000	7.0	—	—	● × 2	—
	Separation tube			UTP-SX236A (18/22/24)		

Note : Please be aware that 2-wired group control is not possible with Simultaneous Multi-split. The WLAN modules from Airstage Mobile are not compatible with Simultaneous Multi

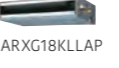
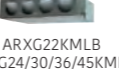
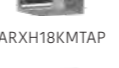
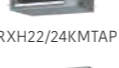

Type		8HP	10HP
Model name		AOHH72KRTA	AOHH90KRTA
Simultaneous Multi-split Outdoor Unit			
	Capacity (kW)	Cooling Heating	19.0 22.4

Indoor Unit	BTU	kW Class	Twin	Triple	Double Twin	Twin	Triple	Double Twin
 AUXG18/22/24KVLA	18,000	5.0	—	—	● × 4	—	—	—
	22,000	6.5	—	—	—	—	—	● × 4
	24,000	7.0	—	● × 3	—	—	—	—
 AUXG18/22/24KRLB	18,000	5.0	—	—	● × 4	—	—	—
	22,000	6.5	—	—	—	—	—	● × 4
	24,000	7.0	—	● × 3	—	—	—	—
 AUXG30/36/45KRLB	30,000	8.8	—	—	—	—	● × 3	—
	36,000	10.6	● × 2	—	—	—	—	—
	45,000	12.5	—	—	—	● × 2	—	—
 ARXG18KLLAP	18,000	5.0	—	—	● × 4	—	—	—
	22,000	6.5	—	—	—	—	—	● × 4
 ARXG22KMLB ARXG24/30/36/45KMLA	24,000	7.0	—	● × 3	—	—	—	—
	30,000	8.8	—	—	—	—	● × 3	—
	36,000	10.6	● × 2	—	—	—	—	—
	45,000	12.5	—	—	—	● × 2	—	—
 ARXH18KMTAP  ARXH22/24KMTAP  ARXH30/36/45KMTAP	18,000	5.0	—	—	● × 4	—	—	—
	22,000	6.5	—	—	—	—	—	● × 4
	24,000	7.0	—	● × 3	—	—	—	—
	30,000	8.8	—	—	—	—	● × 3	—
	36,000	10.6	● × 2	—	—	—	—	—
45,000	12.5	—	—	—	—	● × 2	—	
Separation tube			UTP-SX272A x1	UTP-SX372A x1	UTP-SX272A x1, UTP-SX236A x2	UTP-SX272A x1	UTP-SX372A x1	UTP-SX272A x1, UTP-SX254A x2



Simultaneous Multi-Split Connectable Indoor Units



Type	8HP	10HP	
Model name	AOHG72LRLA	AOHG90LRLA	
Simultaneous Multi-split Outdoor Unit			
Capacity (kW)	Cooling	19.0	22.0
	Heating	22.4	27.0

Indoor Unit	BTU	kW Class	Twin	Triple	Double Twin	Twin	Triple	Double Twin
 AUHG18/22/24LV	18,000	5.0	—	—	● × 4	—	—	—
	22,000	6.5	—	—	—	—	—	● × 4
	24,000	7.0	—	● × 3	—	—	—	—
 AUHG30/36/45LR	30,000	8.8	—	—	—	—	● × 3	—
	36,000	10.6	● × 2	—	—	—	—	—
	45,000	12.5	—	—	—	● × 2	—	—
 ARHG18LLTB	18,000	5.0	—	—	● × 4	—	—	—
 ARHG22/24/30/36/45LM	22,000	6.5	—	—	—	—	—	● × 4
	24,000	7.0	—	● × 3	—	—	—	—
	30,000	8.8	—	—	—	—	● × 3	—
	36,000	10.6	● × 2	—	—	—	—	—
	45,000	12.5	—	—	—	● × 2	—	—
 ABHG18/22/24LV	18,000	5.0	—	—	● × 4	—	—	—
	22,000	6.5	—	—	—	—	—	● × 4
	24,000	7.0	—	● × 3	—	—	—	—
 ABHG30/36/45LR	30,000	8.8	—	—	—	—	● × 3	—
	36,000	10.6	● × 2	—	—	—	—	—
	45,000	12.5	—	—	—	● × 2	—	—
Separation tube			UTP-SX272A × 1	UTP-SX372A × 1	UTP-SX272A × 1, UTP-SX236A × 2	UTP-SX272A × 1	UTP-SX372A × 1	UTP-SX272A × 1, UTP-SX254A × 2

MULTI-SPLIT

NEW

2-unit, 3-unit, Multi-Split (Eco range)



2-unit: AOHH14KACB2 / AOHH18KACB2
3-unit: AOHH18KACB3



Specifications (2-unit)

Model name	AOHH14KACB2		AOHH18KACB2	
Power Source	Single phase, ~230 V, 50 Hz			
Rated Capacity	Cooling	Rated Min.-Max.	kW	
	Heating	Rated Min.-Max.		
EER	Cooling		W/W	
COP	Heating			
Sound Pressure Level (High)	Cooling		dB(A)	
	Heating			
Sound Power Level (High)	Cooling			
	Heating			
Airflow Rate	Cooling/Heating		m ³ /h	
Net Dimensions H x W x D			mm	
Weight			kg	
Connection Pipe Diameter	Liquid		mm	
	Gas			
Max. Pipe Length	Total/Each			
Max. Height Difference	Between Outdoor Unit and Each Indoor Unit		m	
	Between Indoor Units			
Operating Range	Cooling		°CDB	
	Heating			
Refrigerant	Type (Global Warming Potential)		kg (CO2eq-T)	
	Charge			

High Energy Saving

With the adoption of a high-efficiency DC twinrotary* compressor, all models achieved an energy efficiency scale of A++ for cooling and A+ for heating.

*3-units 18 class only

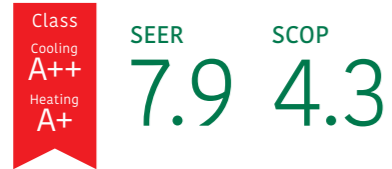

MINIMAL SMART Design

The smart design eliminates mechanical elements and offers a sophisticated, premium impression. Its compact size, with a width of 770 mm, allows for flexible installation in limited room space.



Smart Device Control (Indoor unit)

A WLAN adapter is included as standard equipment. By installing the AIRSTAGE mobile app on your smart device, you can check and control the operating status of the air conditioner from anywhere indoors or outdoors.

* For more information about smart device control, please refer to the page C-022.

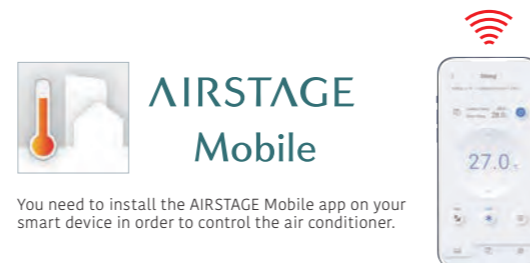

You need to install the AIRSTAGE Mobile app on your smart device in order to control the air conditioner.

Specifications (3-unit)

Model name	AOHH18KACB3			
Power Source	Single phase, ~230 V, 50 Hz			
Rated Capacity	Cooling	Rated Min.-Max.	kW	
	Heating	Rated Min.-Max.		
EER	Cooling		W/W	
COP	Heating			
Sound Pressure Level (High)	Cooling		dB(A)	
	Heating			
Sound Power Level (High)	Cooling			
	Heating			
Airflow Rate	Cooling/Heating		m ³ /h	
Net Dimensions H x W x D			mm	
Weight			kg	
Connection Pipe Diameter	Liquid		mm	
	Gas			
Max. Pipe Length	Total/Each			
Max. Height Difference	Between Outdoor Unit and Each Indoor Unit		m	
	Between Indoor Units			
Operating Range	Cooling		°CDB	
	Heating			
Refrigerant	Type (Global Warming Potential)		kg (CO2eq-T)	
	Charge			

Dimensions

(Unit: mm)

2-unit: AOHH14KACB2 / AOHH18KACB2

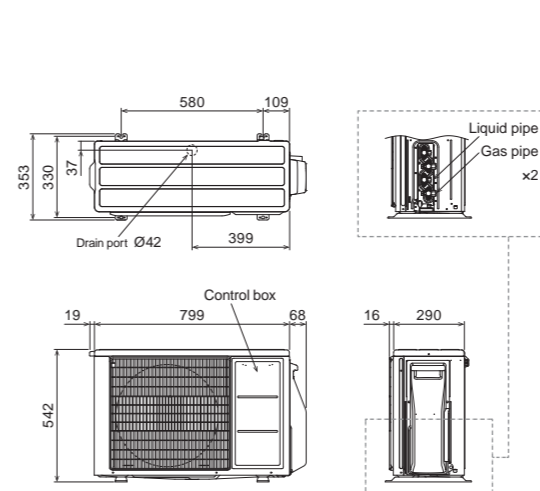

3-unit: AOHH18KACB3

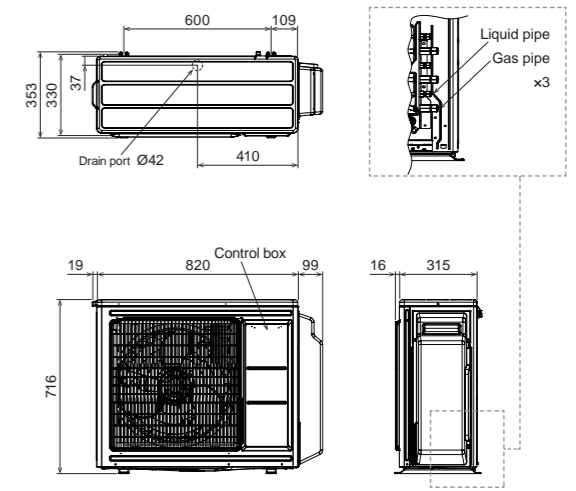

2-unit to 3-unit Multi-Split (Eco range) Indoor Units Specifications

Wall-mounted



Model name	Indoor unit		ASHH07KLTBL	ASHH09KLTBL	ASHH12KLTBL
kW Class	kW		2.0	2.5	3.5
Power Source	Single phase, ~230 V, 50 Hz				
Sound Pressure Level	Cooling	H/M/L/Q	41 / 36 / 29 / 21	43 / 36 / 29 / 21	43 / 37 / 30 / 21
	Heating		41 / 37 / 32 / 23	43 / 37 / 32 / 23	43 / 37 / 32 / 23
Sound Power Level	Cooling	H	56	56	57
	Heating		56	56	57
Airflow Rate	Cooling	H/M/L/Q	600 / 490 / 360 / 240	630 / 490 / 360 / 240	640 / 490 / 370 / 240
	Heating		600 / 510 / 410 / 260	630 / 510 / 410 / 260	640 / 490 / 400 / 260
Net Dimensions	mm		250x770x218	250x770x218	250x770x218
Weight	kg		7.0	7.0	7.5
Connection Pipe Diameter	Liquid/Gas	mm	6.35 / 9.52	6.35 / 9.52	6.35 / 9.52



2-unit,
3-unit,
4-unit,
5-unit,
Multi-Split



High Energy Saving

With the adoption of a high-efficiency DC twin-rotary compressor, all models achieved an energy efficiency scale of A+++ for cooling and A++ for heating.

Class Cooling A+++ Heating A++
SEER 8.7* SCOP 4.7

*: 2-units 14 class when connected with a wall mounted [KG/KM] unit.

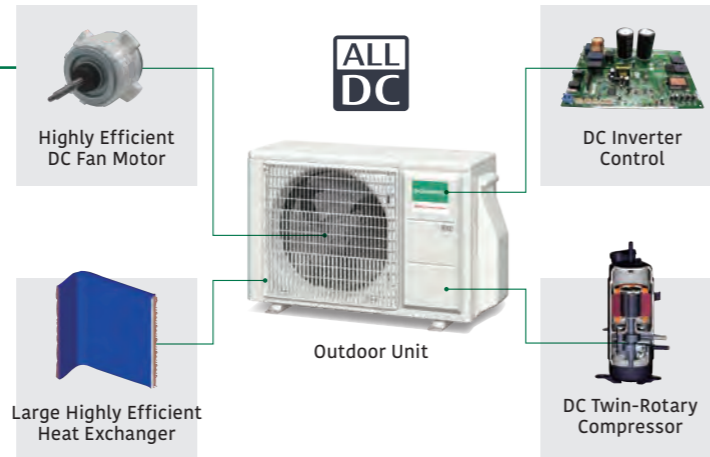

R32 Refrigerant Model

In addition to its high energy efficiency, the R32 refrigerant has a larger volumetric capacity than the R410A refrigerant, which means the R32 refrigerant models require less refrigerant charge than the R410A models.

	Pre-charge refrigerant amount (kg)	
	R32	R410A
2-unit 14 class	0.9	1.25
2-unit 18 class	1.02	1.30
3-unit 18 class	1.8	2.2
3-unit 24 class	1.8	2.2
4-unit 30 class	2.2	3.3
5-unit 36 class	2.5	4.0

Quiet Operation

The sound power level is reduced by up to 7 dB compared to the current R410 models.

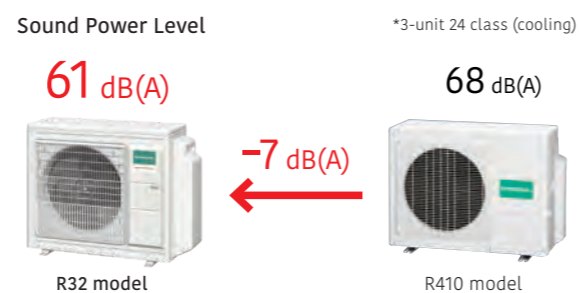

Space-Saving Installation

Multiple indoor units can be connected to 1 outdoor unit by long pipe as well. Unlike a single type, the outdoor unit can be installed in the most space-saving location.



Compact Design

Unlike a single type, the outdoor unit can be installed in the most space-saving location.

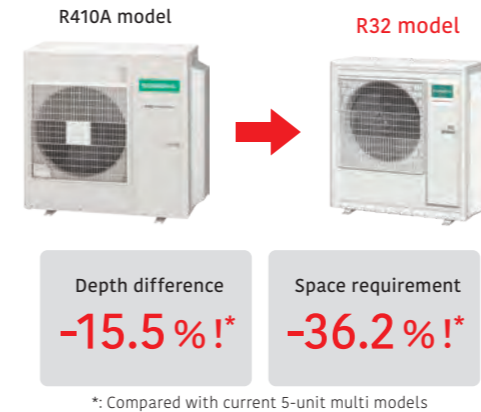

Easy Evacuation

All connected pipes and indoor units can be evacuated quickly via our centralized valve method. Requires evacuation only once.

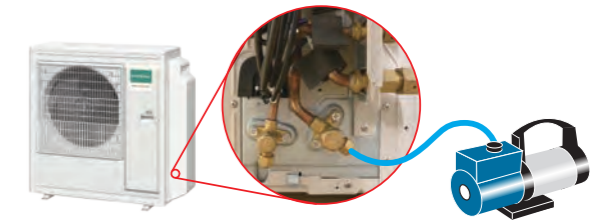

Wide Range of Indoor Units with Various Models

We offer 42 models in 5 types in a capacity range from 2.0 kW to 6.0 kW. Wide range of requirements can be realized from private homes through to large shops and hotels



Models Equipped with the R32 Refrigerant

Wall-mounted with sophisticated design

Designer series



Standard series

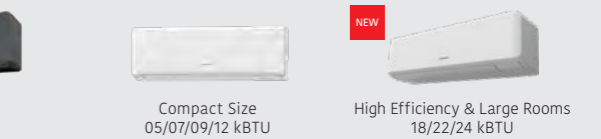

Middle and small capacity models are available. This makes installation easier in small spaces.



2-unit: AOHG14KBTA2 / AOHG18KBTA2
 3-unit: AOHG18KBTA3 / AOHG24KBTA3
 4-unit: AOHG30KBTA4
 5-unit: AOHG36KBTA5



Specifications (2-unit)

Model name		AOHG14KBTA2		AOHG18KBTA2	
Power Source					
Single phase, ~230 V, 50 Hz					
Rated Capacity	Cooling	Rated	kW	4.0	5.0
		Min.-Max.		1.4-4.6	1.7-5.8
Rated Capacity	Heating	Rated	kW	4.4	5.6
		Min.-Max.		1.1-5.5	1.8-6.6
EER	Cooling	W/W	4.12	4.03	
	Heating		4.63	4.59	
COP	Cooling	dB(A)	47	47	
	Heating		49	50	
Sound Pressure Level (High)	Cooling	dB(A)	60	60	
	Heating		62	62	
Sound Power Level (High)	Cooling/Heating	m ³ /h	1,670/1,670	1,960/2,020	
	Net Dimensions H × W × D		mm	542 × 799 × 290	632 × 799 × 290
Weight		kg	33	37	
Connection Pipe Diameter	Liquid	mm	6.35 × 2	6.35 × 2	
	Gas		9.52 × 2	9.52 × 2	
Max. Pipe Length		Total/Each	30/20	30/20	
Max. Height Difference	Between Outdoor Unit and Each Indoor Unit		15	15	
	Between Indoor Units		10	10	
	Cooling	°CDB	-10 to 46	-10 to 46	
Heating	-15 to 24		-15 to 24		
Refrigerant	Type (Global Warming Potential)	kg (CO ₂ eq-T)	R32 (675)	R32 (675)	
	Charge		0.9 (0.608)	1.02 (0.689)	

Specifications (3-unit)

Model name		AOHG18KBTA3		AOHG24KBTA3	
Power Source					
Single phase, ~230 V, 50 Hz					
Rated Capacity	Cooling	Rated	kW	5.4	6.8
		Min.-Max.		1.8-7.0	1.8-8.5
Rated Capacity	Heating	Rated	kW	6.8	8.0
		Min.-Max.		2.0-8.0	2.0-9.2
EER	Cooling	W/W	4.78	3.90	
	Heating		4.89	4.40	
COP	Cooling	dB(A)	46	48	
	Heating		49	53	
Sound Pressure Level (High)	Cooling	dB(A)	59	61	
	Heating		61	67	
Sound Power Level (High)	Cooling/Heating	m ³ /h	2,220/2,160	2,270/2,730	
	Net Dimensions H × W × D		mm	716 × 820 × 315	716 × 820 × 315
Weight		kg	46	46	
Connection Pipe Diameter	Liquid	mm	6.35 × 3	6.35 × 3	
	Gas		9.52 × 3	9.52 × 2, 12.70 × 1 adapter [12.70 → 9.52] × 1	
Max. Pipe Length		Total/Each	50/25	50/25	
Max. Height Difference	Between Outdoor Unit and Each Indoor Unit		15	15	
	Between Indoor Units		10	10	
	Cooling	°CDB	-10 to 46	-10 to 46	
Heating	-15 to 24		-15 to 24		
Refrigerant	Type (Global Warming Potential)	kg (CO ₂ eq-T)	R32 (675)	R32 (675)	
	Charge		1.8 (1.215)	1.8 (1.215)	

Specifications (4-unit, 5-unit)

Model name		AOHG30KBTA4		AOHG36KBTA5	
Power Source					
Single phase, ~230 V, 50 Hz					
Rated Capacity	Cooling	Rated	kW	8.0	9.5
		Min.-Max.		2.4-10.1	3.0-11.0
Rated Capacity	Heating	Rated	kW	9.6	10.6
		Min.-Max.		3.0-11.2	3.5-12.0
EER	Cooling	W/W	3.90	3.80	
	Heating		4.55	4.50	
COP	Cooling	dB(A)	50	52	
	Heating		54	55	
Sound Pressure Level (High)	Cooling	dB(A)	63	65	
	Heating		66	68	
Sound Power Level (High)	Cooling/Heating	m ³ /h	2,400/2,950	2,450/2,900	
	Net Dimensions H × W × D		mm	884 × 820 × 315	884 × 820 × 315
Weight		kg	55	59	
Connection Pipe Diameter	Liquid	mm	6.35 × 4	6.35 × 5	
	Gas		9.52 × 2, 12.70 × 2 adapter [12.70 → 9.52] × 2	9.52 × 3, 12.70 × 2 adapter [12.70 → 9.52] × 2 adapter [9.52 → 12.70] × 1	
Max. Pipe Length*		Total/Each	70/25	75/25	
Max. Height Difference	Between Outdoor Unit and Each Indoor Unit		15	15	
	Between Indoor Units		10	10	
	Cooling	°CDB	-10 to 46	-10 to 46	
Heating	-15 to 24		-15 to 24		
Refrigerant	Type (Global Warming Potential)	kg (CO ₂ eq-T)	R32 (675)	R32 (675)	
	Charge		2.2 (1.485)	2.5 (1.688)	

*Length not applicable when floor units are connected. For details, refer to the installation manual.

Dimensions

(Unit: mm)

2-unit: AOHG14KBTA2

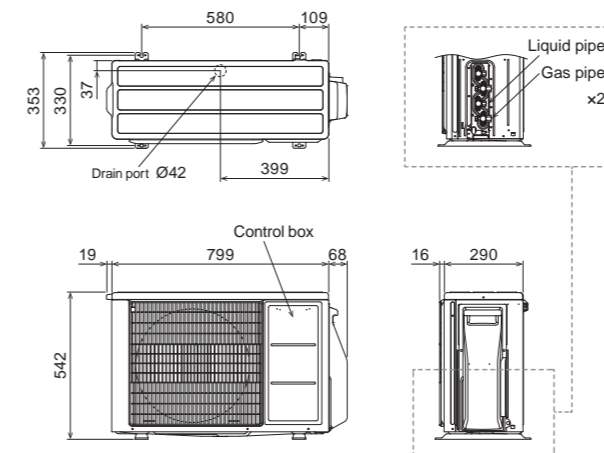

2-unit: AOHG18KBTA2

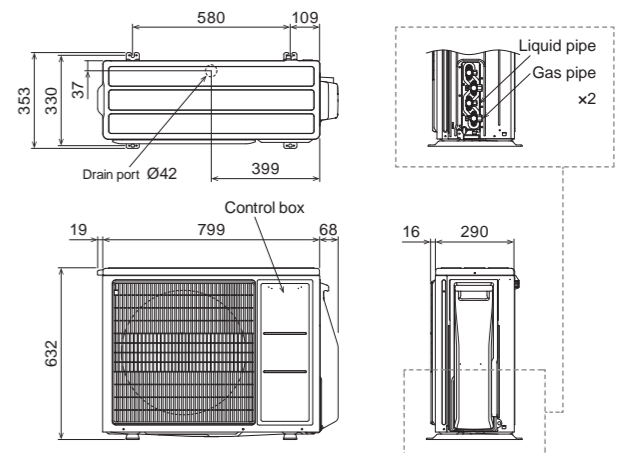

3-unit: AOHG18KBTA3 / AOHG24KBTA3

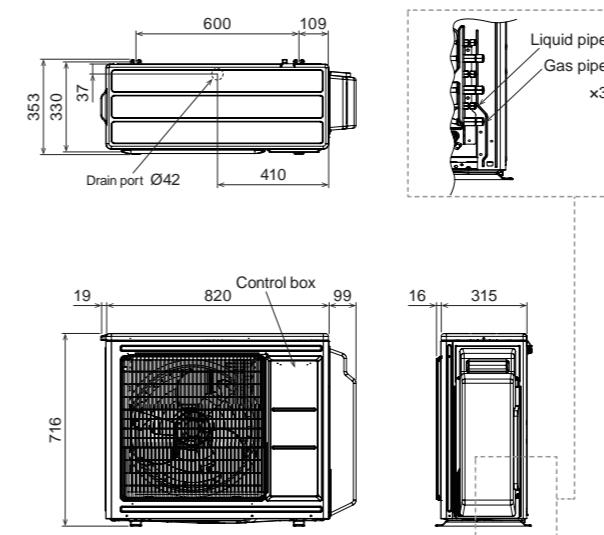

**4-unit: AOHG30KBTA4
5-unit: AOHG36KBTA5**

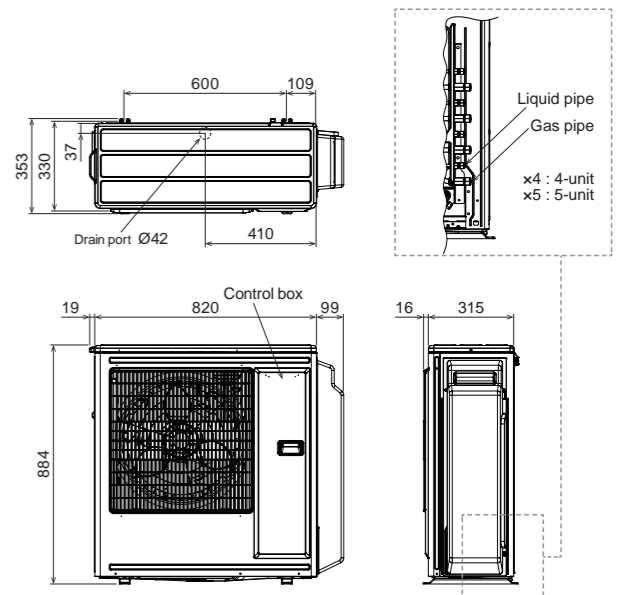

MULTI-SPLIT

6-unit Multi-Split



6-unit: AOHG45LBA6

Specifications

Model name			AOHG45LBA6	
Power Source			Single phase, ~230 V, 50 Hz	
Rated Capacity	Cooling	Rated	kW	12.5
		Min.-Max.		3.5-14.0
	Heating	Rated		13.5
		Min.-Max.		3.5-16.0
EER	Cooling	W/W	3.50	
COP	Heating	W/W	4.00	
Sound Pressure Level (High)	Cooling	dB(A)	53	
	Heating		55	
Sound Power Level (High)	Cooling		-	
	Heating		-	
Airflow Rate	Cooling/Heating	m ³ /h	4,200/4,200	
Net Dimensions H × W × D			mm	998 × 970 × 370
Weight			kg	94
Connection Pipe Diameter	Liquid	mm	6.35 × 6	
	Gas		9.52 × 4, 12.70 × 2	
Max. Pipe Length	Total/Each		80/25	
	Between Outdoor Unit and Each Indoor Unit.		15	
Max. Height Difference	Between Indoor Units.		10	
	Cooling	°CDB	-10 to 46	
Heating	-15 to 24			
Refrigerant	Type (Global Warming Potential)		R410A (2,088)	
	Charge	kg (CO ₂ eq-T)	4.00 (8.352)	

A Wide Variety of Models to Choose from

We offer 26 models in 5 types in a capacity range from 2.0 kW to 7.0 kW. A wide range of requirements can be realized from private homes through to large shops and hotels.

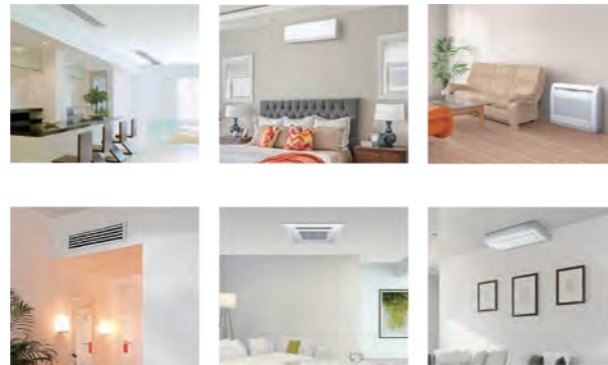

Compact Design

Multiple indoor units can be connected to 1 outdoor unit by long pipe as well. Unlike a single type, the outdoor unit can be installed in the most space-saving location.



Easy Installation

All connected pipes and indoor units can be evacuated quickly via our centralized valve method. Requires evacuation only once.

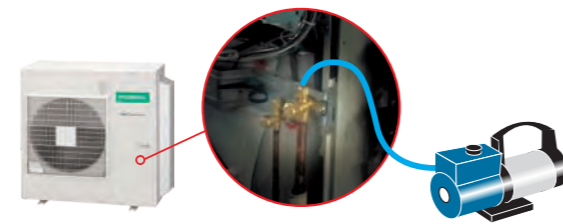

Central & Individual Control

- Batched control of up to 6 indoor units. Unified setting of room temperature, airflow volume, and local control restrictions across units.
- Language can be selected from English, French, German, Greek, Italian, Portuguese, Russian, Spanish, or Turkish.
- Large backlit indicator lamp screen
- Large easy-to-see operation panel

Max. Controllable
1 multi-system
Max. Controllable
6 indoor units



Dimensions

(Unit: mm)

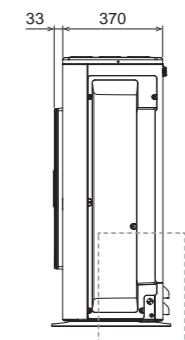
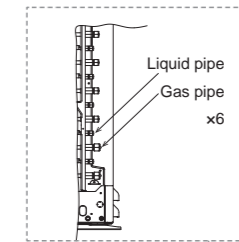
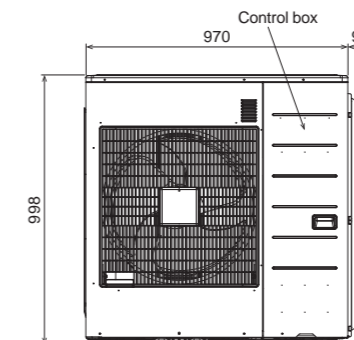
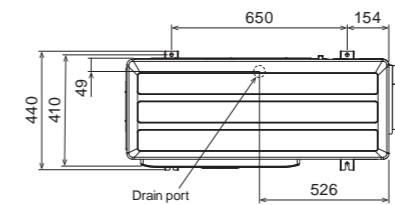

Simultaneous Multi-Split Type

Twin / Triple



Meets a variety of installation needs from offices to commercial spaces, with up to 3 indoor units in the same room connected to an outdoor unit.

Select indoor units according to floor layout and heat load estimated by the number of people working in the room and the direction and intensity of sunlight entering the room. Perfect airflow distribution can be achieved for optimum comfort.

Installation according to floor layout

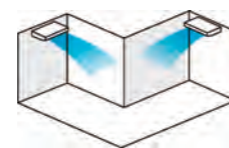

Installation according to lighting conditions

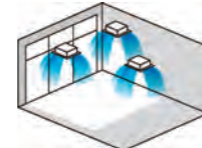

Design Flexibility

Slim & Compact Design

The outdoor unit in this series is 22.7% shorter* than a twin-fan outdoor unit. The reduced height makes it easy to install in tight spaces.

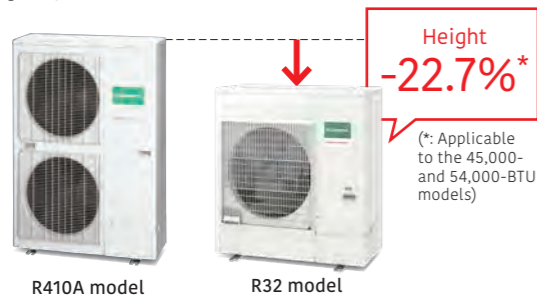

Flexible Installation

Pipe length of up to 50 m and a height difference of up to 30 m can be accommodated. Multi-split systems can be installed in large residences and multi-story buildings.

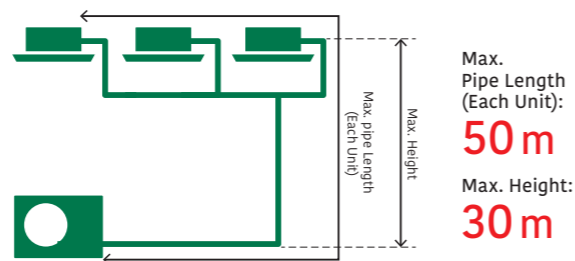

Lineup of Indoor Units

The indoor units, available in 6 models of 3 types, can be selected according to room size and conditions.



Note : Please be aware that 2-wired group control is not possible with Simultaneous Multi-split.

Model: AOHG36KBTB / AOHG45KBTB / AOHG54KBTB
AOHG36KRTA [3-phase] / AOHG45KRTA [3-phase] / AOHG54KRTA [3-phase]



Specifications (Indoor units/Outdoor units)

Indoor Units Model name	Compact Cassette		
	AUXG18KVLA	AUXG22KVLA	AUXG24KVLA
Power Source	Single phase, ~230 V, 50 Hz		
Airflow Rate	Cooling H/M/L/Q 800/680/580/450	830/740/600/450	930/830/600/450
Net Dimensions H × W × D	245 × 570 × 570	245 × 570 × 570	245 × 570 × 570
Weight	15	16	16
Cassette Grille	UTG-UFGF-W	UTG-UFGF-W	UTG-UFGF-W

Indoor Units Model name	Duct		
	ARXC18KLLAP	ARXG22KMLB	ARXG24KMLA
Power Source	Single phase, ~230 V, 50 Hz		
Airflow Rate	Cooling H/M/L/Q 940/880/820/750	1,100/910/750/580	1,100/910/750/580
Net Dimensions H × W × D	198 × 900 × 620	270 × 1,135 × 700	270 × 1,135 × 700
Weight	20	35	35

Outdoor Units Model name	AOHG36KBTB	AOHG45KBTB	AOHG54KBTB	AOHG36KRTA	AOHG45KRTA	AOHG54KRTA
	Capacity	Cooling 9.5	12.1	13.4	9.5	12.1
Power Source	Single phase, ~230 V, 50 Hz			3-phase, ~400 V, 50 Hz		
Pdesign	Cooling 8.7	-	-	8.7	-	-
SEER	Cooling 6.10	-	-	6.10	-	-
SCOP	Heating 4.00	-	-	4.00	-	-
Annual Energy Consumption	Cooling 545	-	-	545	-	-
Energy Efficiency Class	Heating A+	-	-	A+	-	-
Sound Pressure Level (High)	Cooling 55	57	57	55	57	57
Sound Power Level (High)	Heating 70	71	73	70	71	73
Airflow Rate	Cooling/Heating 3,750/3,750	4,450/4,450	4,450/4,450	3,750/3,750	4,450/4,450	4,450/4,450
Net Dimensions H × W × D	788 × 940 × 320	998 × 940 × 320	998 × 940 × 320	788 × 940 × 320	998 × 940 × 320	998 × 940 × 320
Weight	52	67	67	53	67	67
Connection Pipe Diameter (Liquid/Gas)	9.52/15.88	9.52/15.88	9.52/15.88	9.52/15.88	9.52/15.88	9.52/15.88
Max. Pipe Length (Pre-Charge)	50 (30)	50 (30)	50 (30)	50 (30)	50 (30)	50 (30)
Max. Height Difference	30	30	30	30	30	30
Operating Range	Cooling -15 to 46	-15 to 46	-15 to 46	-15 to 46	-15 to 46	-15 to 46
Refrigerant	Heating R32 (675)	R32 (675)	R32 (675)	R32 (675)	R32 (675)	R32 (675)
Charge	1.90 (1.283)	2.70 (1.823)	2.70 (1.823)	1.90 (1.283)	2.70 (1.823)	2.70 (1.823)
Separation tube	UTP-SX236A (Twin)	UTP-SX236A (Twin)	UTP-SX236A (Twin) UTP-SX354A (Triple)	UTP-SX236A (Twin)	UTP-SX236A (Twin)	UTP-SX236A (Twin) UTP-SX354A (Triple)

* Indoor units of different types and capacity cannot be connected.
• The above specifications apply when used with a cassette type indoor unit.

Dimensions

(Unit: mm)

AOHG36KBTB / AOHG36KRTA

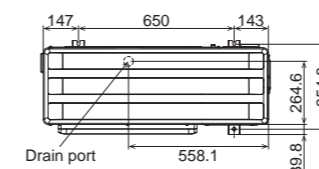

AOHG45KBTB / AOHG54KBTB AOHG45KRTA / AOHG54KRTA

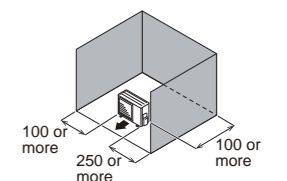
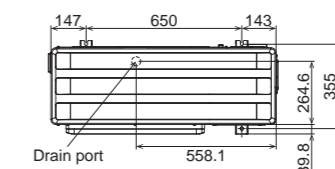

Installation restriction
*One example is shown. Installation restrictions vary depending on the installation environment. For details on installation restrictions under other conditions, refer to the installation manual.

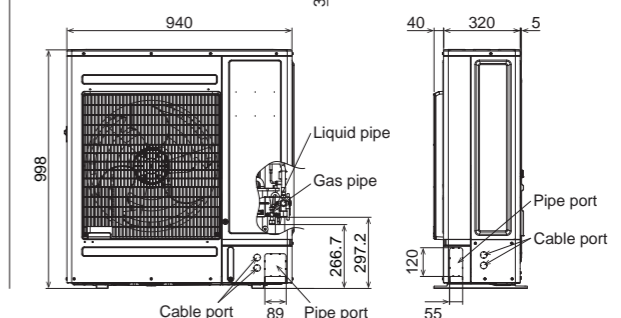
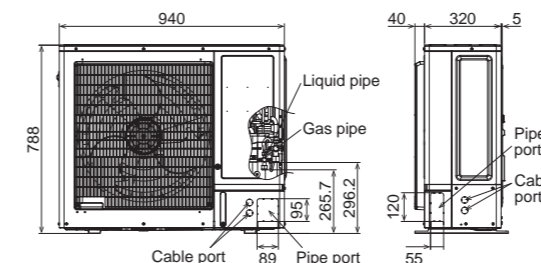

MULTI-SPLIT

NEW

Simultaneous Multi-Split Type

Twin / Triple / Double Twin



Meets a variety of installation needs from an open-plan office to a retail store, with up to 4 indoor units connected to an outdoor unit.

Select indoor units according to floor layout and heat load estimated by the number of people working in the room and the direction and intensity of sunlight entering the room. Perfect airflow distribution can be achieved for optimum comfort.



Simultaneous Control

Up to 16 indoor units can be controlled simultaneously with a wired remote controller.

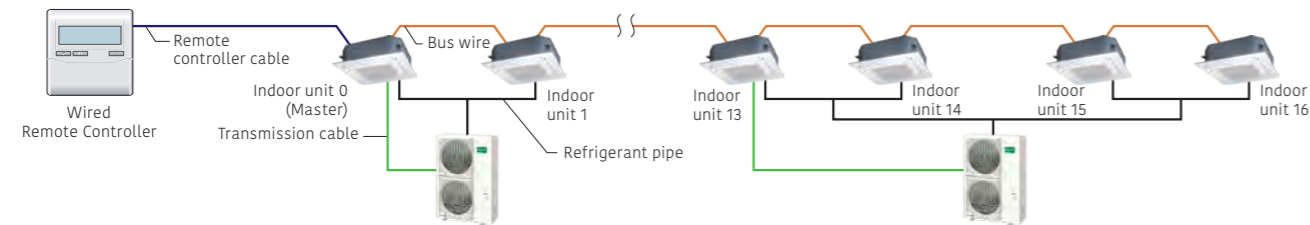

*The following wireless remote controller functions are not available for Compact Cassette, Circular Flow Cassette, Duct (A**G models):
 Timer Operation, Sleep Timer Operation, 10°C Heating Operation
 *The following function is not available for Medium Static Pressure Duct (ARXH**KMTAP): 10°C Heating Operation
 *The connectable remote controllers differ depending on the indoor unit.
 *The KMTAP is compatible with nonpolar 2-core types (UTY-RVRG/UTY-RNRGZ6/UTY-RLRG/UTY-RCRGZ1/UTY-RSRGZ1 / UTY-RHRGZ1).
 For all other types, the polarised three-wire remote controller (UTY-RNNGM) is compatible.

Indoor Unit Lineup

The indoor units, available in 21 models of 6 types, can be selected according to room size and conditions.



Model: AOHH72KRTA [3-phase] / AOHH90KRTA [3-phase]



Specifications (Indoor units/Outdoor units)

Indoor Units Model name	Compact Cassette		
	AUXG18KVLA	AUXG22KVLA	AUXG24KVLA
Power Source	Single phase, ~230 V, 50 Hz		
Airflow Rate	680/580/490/410	830/740/600/450	930/830/600/450
Net Dimensions H x W x D	245 x 570 x 570	245 x 570 x 570	245 x 570 x 570
Weight	15	16	16
Cassette Grille	UTG-UFGF-W		

Indoor Units Model name	Circular flow cassette				
	AUXG18KRLB	AUXG22KRLB	AUXG30KRLB	AUXG36KRLB	AUXG45KRLB
Power Source	Single phase, ~230 V, 50 Hz				
Airflow Rate	1,050/960/900/780	1,050/960/900/780	1,150/1,050/980/870	1,600/1,400/1,270/1,150	1,870/1,560/1,410/1,160
Net Dimensions H x W x D	246 x 840 x 840	246 x 840 x 840	246 x 840 x 840	288 x 840 x 840	288 x 840 x 840
Weight	23	23	24	26	29
Cassette Grille	UTG-UKGA-W: White wired remote controller (touch panel) / UTG-UKGC-W: White / UTG-UKGA-B*1: Black				

*1: IR Receiver Kit and Occupancy Sensor Kit cannot be connected.

Indoor Units Model name	Duct					
	ARXG18KLLAP	ARXG22KMLB	ARXG24KMLA	ARXG30KMLA	ARXG36KMLA	ARXG45KMLA
Power Source	Single phase, ~230 V, 50 Hz					
Airflow Rate	940/880/820/750	1,100/910/750/580	1,100/910/750/580	1,900/1,620/1,270/980	1,900/1,620/1,270/980	2,100/1,750/1,350/1,070
Net Dimensions H x W x D	198 x 900 x 620	270 x 1,135 x 700	270 x 1,135 x 700	270 x 1,135 x 700	270 x 1,135 x 700	270 x 1,135 x 700
Weight	20	35	35	38	38	39

Indoor Units Model name	Duct					
	ARXH18KMTAP	ARXH22KMTAP	ARXH24KMTAP	ARXH30KMTAP	ARXH36KMTAP	ARXH45KMTAP
Power Source	Single phase, ~230 V, 50 Hz					
Airflow Rate	840/720/630/540	1,150/920/800/700	1,230/980/860/740	1,950/1,540/1,340/1,210	2,070/1,660/1,450/1,280	2,160/1,730/1,510/1,320
Net Dimensions H x W x D	240 x 700 x 700	240 x 1,000 x 700	240 x 1,000 x 700	240 x 1,400 x 700	240 x 1,400 x 700	240 x 1,400 x 700
Weight	24	31	31	42	42	42

Outdoor Units Model name	AOHH72KRTA		AOHH90KRTA		
	Capacity	Power Source	Capacity	Power Source	
Capacity	22.0	3-phase, ~400 V, 50 Hz	19.0	3-phase, ~400 V, 50 Hz	
Power Source	24.0		22.4		
Sound Pressure Level (High)	61/64		61/64		
Sound Power Level (High)	77/77		75/75		
Airflow Rate	9,300 / 9,300		9,300 / 9,300		
Net Dimensions H x W x D	1,418 x 970 x 370		1,418 x 970 x 370		
Weight	103		103		
Connection Pipe Diameter (Liquid/Gas)	12.7 / 19.05		12.7 / 19.05		
Max. Pipe Length (Pre-Charge)	100 (40)		100 (40)		
Max. Height Difference	30		30		
Operating Range	-15 to 50		-15 to 50		
Refrigerant	R32 (675)		R32 (675)		
Charge	4.00 (2.700)		4.00 (2.700)		
Separation tube	UTP-SX290A x 1 (Twin)	UTP-SX372B x 1 (Triple)	UTP-SX290A x 1 (Twin)	UTP-SX390A x 1 (Triple)	UTP-SX290A x 1 (Twin) UTP-SX236A x 2 (Double Twin)

*: That specification is not fixed yet.

• Indoor units of different types and capacity cannot be connected.
 • The above specifications apply when used with a cassette type indoor unit.

Dimensions

(Unit: mm)

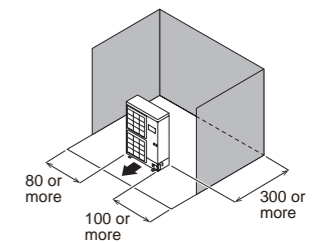
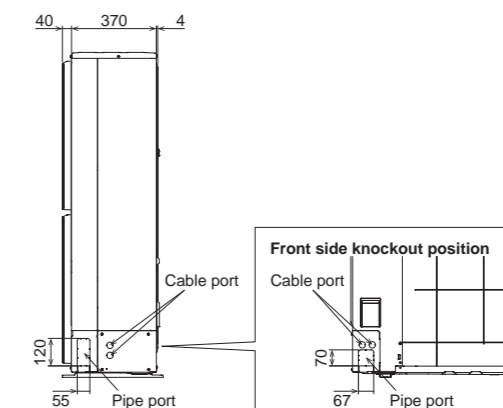
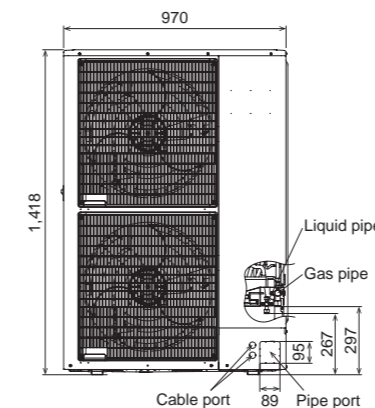
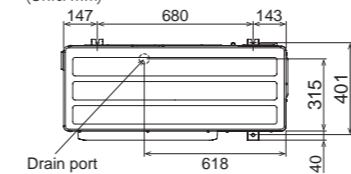

Installation restriction
 *One example is shown. Installation restrictions vary depending on the installation environment. For details on installation restrictions under other conditions, refer to the installation manual.

MULTI-SPLIT

Simultaneous Multi-Split Type

Twin / Triple / Double Twin



Meets a variety of installation needs from an open-plan office to a retail store, with up to 4 indoor units connected to an outdoor unit.

Select indoor units according to floor layout and heat load estimated by the number of people working in the room and the direction and intensity of sunlight entering the room. Perfect airflow distribution can be achieved for optimum comfort.

Installation according to floor layout

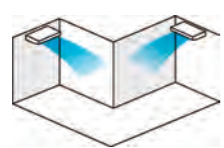

Installation according to lighting conditions

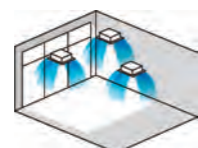

Installation according to layout and lighting conditions

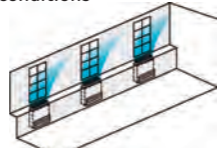

Installation according to large space



Simultaneous Control

Up to 16 indoor units can be controlled simultaneously with a wired remote controller.

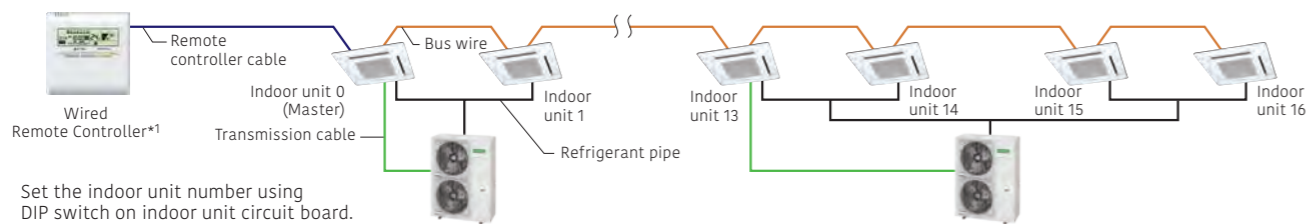

Set the indoor unit number using DIP switch on indoor unit circuit board.

*The following functions are not provided by a wireless remote controller: Timer operation, Sleep Timer operation, 10°C Heat operation
*1: Only the 3-wire remote control (UTY-RVNGM/UTY-RNNGM) can be used.

Indoor Unit Lineup

The indoor units, available in 18 models of 6 types, can be selected according to room size and conditions.



Model: AOHG72LRLA [3-phase] / AOHG90LRLA [3-phase]



Specifications (Indoor units/Outdoor units)

Indoor Units Model name	Compact Cassette, Cassette					
	AUHG18VLB	AUHG22VLA	AUHG24VLA	AUHG30LRE	AUHG36LRE	AUHG45LRLA
Power Source	Single phase, ~230 V, 50 Hz					
Airflow Rate	Cooling H/M/L/Q Heating H/M/L/Q	m ³ /h	750/610/520/410 800/710/600/450	930/830/600/450 930/860/700/530	930/830/600/450 1,800/1,400/1,270/1,150	1,600/1,400/1,270/1,150 1,800/1,400/1,270/1,150
Net Dimensions H × W × D	mm		245 × 570 × 570	245 × 570 × 570	245 × 570 × 570	288 × 840 × 840
Weight	kg		15	16	16	26
Cassette Grille	UTG-UFGD-W			UTG-UGGA-W		

Indoor Units Model name	Duct					
	ARHG18LLTB	ARHG22MLA	ARHG24MLA	ARHG30LMLE	ARHG36LMLE	ARHG45LMLA
Power Source	Single phase, ~230 V, 50 Hz					
Airflow Rate	Cooling H/M/L/Q Heating H/M/L/Q	m ³ /h	940/880/820/750 940/880/820/750	1,100/910/750/580 1,100/910/750/580	1,100/910/750/580 1,900/1,620/1,270/980	1,900/1,620/1,270/980 2,100/1,620/1,270/980
Net Dimensions H × W × D	mm		198 × 900 × 620	270 × 1135 × 700	270 × 1135 × 700	270 × 1135 × 700
Weight	kg		23	38	40	40 (88)

Indoor Units Model name	Floor/Ceiling, Ceiling					
	ABHG18LVTB	ABHG22LVTA	ABHG24LVTA	ABHG30LRTE	ABHG36LRTE	ABHG45LRTA
Power Source	Single phase, ~230 V, 50 Hz					
Airflow Rate	Cooling H/M/L/Q Heating H/M/L/Q	m ³ /h	780/700/560/500 780/700/560/500	980/820/680/540 980/820/680/540	980/820/680/540 1,660/1,500/1,200/1,000	1,660/1,500/1,200/1,000 1,900/1,500/1,200/1,000
Net Dimensions H × W × D	mm		199 × 990 × 655	199 × 990 × 655	199 × 990 × 655	240 × 1660 × 700
Weight	kg		27	27	27	46

Outdoor Units Model name	AOHG72LRLA		AOHG90LRLA	
	Capacity	Cooling Heating	kW	19.0 22.4
Power Source	3-phase, ~400 V, 50 Hz			
Sound Pressure Level (High)	Cooling/Heating	dB(A)	55/55	55/57
Airflow Rate	Cooling/Heating	m ³ /h	8,400/8,400	8,400/9,000
Net Dimensions H × W × D	mm		1,428 × 1,080 × 480	1,428 × 1,080 × 480
Weight	kg		163	172
Connection Pipe Diameter (Liquid/Gas)	mm		12.7/25.4	12.7/25.4
Max. Pipe Length (Pre-Charge)	m		100 (30)	100 (30)
Max. Height Difference	m		30	30
Operating Range	Cooling Heating	°CDB	-15 to 46 -20 to 24	-15 to 46 -20 to 24
Refrigerant	Type (Global Warming Potential) Charge	kg (CO ₂ eq-T)	R410A (2,088) 5.6 (11.693)	R410A (2,088) 7.1 (14.825)
Separation tube			UTP-SX272A × 1 (Twin)	UTP-SX372A × 1 (Triple)
			UTP-SX272A × 1 UTP-SX236A × 2 (Double Twin)	UTP-SX272A × 1 (Twin) UTP-SX372A × 1 (Triple) UTP-SX254A × 2 (Double Twin)

*: That specification is not fixed yet.

• Indoor units of different types and capacity cannot be connected.
• The above specifications apply when used with a cassette type indoor unit.

Dimensions

(Unit: mm)

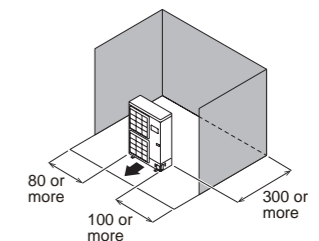
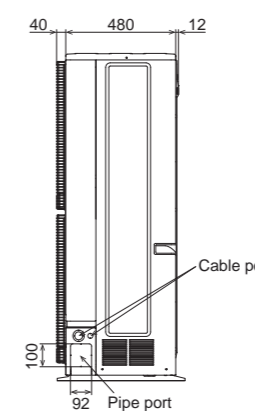
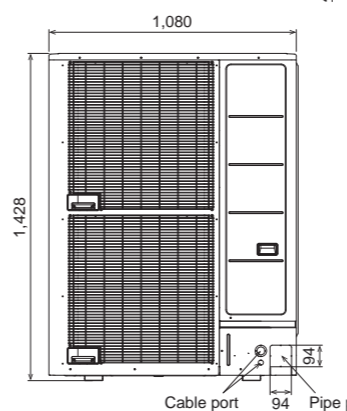
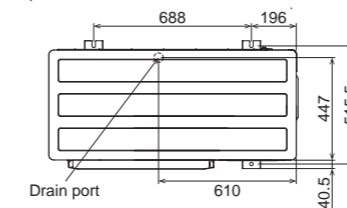

Installation restriction
*One example is shown. Installation restrictions vary depending on the installation environment. For details on installation restrictions under other conditions, refer to the installation manual.

2-unit to 5-unit Multi-Split Indoor Units Specifications



Wall-mounted

NEW



Model name	Indoor unit			ASHH05KJCAL ASHH05KJCALB ASHH05KJCA ASHH05KJCA-B	ASHH07KJCAL ASHH07KJCALB ASHH07KJCA ASHH07KJCA-B	ASHH09KJCAL ASHH09KJCALB ASHH09KJCA ASHH09KJCA-B	ASHH12KJCAL ASHH12KJCALB ASHH12KJCA ASHH12KJCA-B	ASHH14KJCAL ASHH14KJCALB ASHH14KJCA ASHH14KJCA-B
kW Class	kW			1.5	2.0	2.5	3.5	4.0
Power Source				Single phase, 230V, ~50Hz				
Sound Pressure Level	Cooling	H/M/L/Q	dB(A)	34/31/24/21	36/31/24/21	40/31/24/21	41/34/26/22	45/35/26/22
	Heating			34/31/24/22	36/31/24/22	40/31/24/22	41/34/25/22	44/35/25/22
Sound Power Level	Cooling	H	dB(A)	50	51	55	56	59
	Heating			50	51	56	56	59
Airflow Rate	Cooling	H/M/L/Q	m³/h	500/430/330/260	540/430/330/260	640/430/330/260	630/470/340/290	720/490/340/290
	Heating			500/430/330/260	540/430/330/260	640/430/330/260	630/470/320/250	720/490/320/250
Net Dimensions	mm			270 × 798 × 240	270 × 798 × 240	270 × 798 × 240	270 × 798 × 240	270 × 798 × 240
Weight	kg			10	10	10	10.5	10.5
Connection Pipe Diameter	Liquid/Gas	mm		6.35/9.52	6.35/9.52	6.35/9.52	6.35/9.52	6.35/9.52

Wall-mounted

NEW



Model name	Indoor unit			ASHH07KMCG ASHH07KMCG-B ASHG07KMCF	ASHH09KMCG ASHH09KMCG-B ASHG09KMCF	ASHH12KMCG ASHH12KMCG-B ASHG12KMCF	ASHH14KMCG ASHH14KMCG-B ASHG14KMCF
kW Class	kW			2.0	2.5	3.5	4.0
Power Source				Single phase, ~230 V, 50 Hz			
Sound Pressure Level	Cooling	H/M/L/Q	dB(A)	38/33/29/21	40/34/29/21	40/35/30/21	43/36/30/21
	Heating			41/35/31/22	42/36/31/22	42/38/33/22	44/39/33/24
Sound Power Level	Cooling	H	dB(A)	54	55	55	57
	Heating			56	57	58	59
Airflow Rate	Cooling	H/M/L/Q	m³/h	650/540/430/320	700/560/430/320	700/560/430/320	770/600/450/310
	Heating			720/580/460/330	750/610/470/330	780/640/520/330	820/660/520/340
Net Dimensions	mm			270 × 834 × 215	270 × 834 × 215	270 × 834 × 215	270 × 834 × 215
Weight	kg			10	10	10	10
Connection Pipe Diameter	Liquid/Gas	mm		6.35/9.52	6.35/9.52	6.35/9.52	6.35/9.52

Wall-mounted

NEW



Model name	Indoor unit			ASHH05KNCA	ASHH07KNCA	ASHH09KNCA	ASHH12KNCA
kW Class	kW			1.5	2.0	2.5	3.5
Power Source				Single phase, ~230 V, 50 Hz			
Sound Pressure Level	Cooling	H/M/L/Q	dB(A)	34 / 33 / 29 / 21	36 / 33 / 29 / 21	41 / 35 / 29 / 21	42 / 36 / 32 / 21
	Heating			34 / 32 / 30 / 22	36 / 33 / 30 / 22	41 / 34 / 30 / 22	42 / 35 / 31 / 22
Sound Power Level	Cooling	H	dB(A)	50	51	56	57
	Heating			50	51	56	57
Airflow Rate	Cooling	H/M/L/Q	m³/h	500 / 450 / 390 / 250	530 / 460 / 390 / 250	640 / 500 / 390 / 250	660 / 520 / 440 / 250
	Heating			500 / 450 / 420 / 280	530 / 460 / 420 / 280	640 / 500 / 420 / 280	660 / 520 / 440 / 280
Net Dimensions	mm			270 × 784 × 222	270 × 784 × 222	270 × 784 × 222	270 × 784 × 222
Weight	kg			9	9	9	9
Connection Pipe Diameter	Liquid/Gas	mm		6.35 / 9.52	6.35 / 9.52	6.35 / 9.52	6.35 / 9.52

Wall-mounted

NEW



Model name	Indoor unit			ASHH18KMTGL	ASHH22KMTGL	ASHH24KMTGL
kW Class	kW			5.0	6.0	7.0
Power Source				Single phase, ~230 V, 50 Hz		
Sound Pressure Level	Cooling	H/M/L/Q	dB(A)	45/40/35/29	48/40/35/29	49/40/35/29
	Heating			46/40/35/29	48/40/35/29	49/40/35/29
Sound Power Level	Cooling	H	dB(A)	60	62	65
	Heating			61	62	65
Airflow Rate	Cooling	H/M/L/Q	m³/h	980/810/640/510	1,060/810/640/510	1,170/850/640/510
	Heating			1,020/850/640/510	1,060/850/640/510	1,170/850/640/510
Net Dimensions	mm			280 × 980 × 240	280 × 980 × 240	280 × 980 × 240
Weight	kg			12.5	12.5	12.5
Connection Pipe Diameter	Liquid/Gas	mm		6.35/12.70	6.35/12.70	6.35/12.70

Floor

NEW



Model name	Indoor unit			AGHG09KVCA	AGHG12KVCA	AGHG14KVCA
kW Class	kW			2.5	3.5	4.0
Power Source				Single phase, ~230 V, 50 Hz		
Sound Pressure Level	Cooling	H/M/L/Q	dB(A)	39/34/28/22	42/36/30/22	44/38/31/22
	Heating			39/35/30/22	42/38/32/22	44/39/33/22
Sound Power Level	Cooling	H	dB(A)	52	55	56
	Heating			52	55	56
Airflow Rate	Cooling	H/M/L/Q	m³/h	530/440/360/270	600/490/380/270	650/520/400/270
	Heating			530/460/380/270	600/510/410/270	650/540/430/270
Net Dimensions	mm			600 × 740 × 200	600 × 740 × 200	600 × 740 × 200
Weight	kg			14	14	14
Connection Pipe Diameter	Liquid/Gas	mm		6.35/9.52	6.35/9.52	6.35/9.52

Ceiling

NEW



Model name	Indoor unit			ABHG18KRTA	ABHG22KRTA
kW Class	kW			5.0	6.0
Power Source				Single phase, ~230 V, 50 Hz	
Sound Pressure Level	Cooling	H/M/L/Q	dB(A)	38/36/33/31	42/37/34/31
	Heating			38/36/33/31	42/37/34/31
Sound Power Level	Cooling	H	dB(A)	53	57
	Heating			53	57
Airflow Rate	Cooling	H/M/L/Q	m³/h	840/790/710/650	900/790/710/650
	Heating			840/790/710/650	900/790/710/650
Net Dimensions	mm			235 × 1,080 × 705	235 × 1,080 × 705
Weight	kg			24	24
Connection Pipe Diameter	Liquid/Gas	mm		6.35/12.70	6.35/12.70



2-unit to 5-unit Multi-Split Indoor Units Specifications

Compact Cassette Grid Type



Model name	Indoor unit		AUXG07KVLA	AUXG09KVLA	AUXG12KVLA	AUXG14KVLA	AUXG18KVLA	AUXG22KVLA	
kW Class	kW		2.0	2.5	3.5	4.0	5.0	6.0	
Power Source	Single phase, ~230 V, 50 Hz								
Sound Pressure Level	Cooling	H/M/L/Q	dB(A)	33/31/29/27	33/31/29/27	37/34/31/28	38/35/32/29	38/35/32/29	44/42/36/30
	Heating			34/32/29/27	34/32/29/27	37/34/31/29	43/38/34/30	43/38/34/30	45/43/40/33
Sound Power Level	Cooling	H	dB(A)	46	46	49	50	50	56
	Heating			47	47	49	55	55	57
Airflow Rate	Cooling	H/M/L/Q	m³/h	540/490/440/390	540/490/440/390	610/530/470/410	680/580/490/410	680/580/490/410	830/740/600/450
	Heating			540/490/440/390	540/490/440/390	610/530/470/410	790/680/580/450	790/680/580/450	860/760/700/530
Net Dimensions	mm		245 × 570 × 570		245 × 570 × 570		245 × 570 × 570		
Weight	kg		15		15		16		
Panel			UTG-UFGF-W		UTG-UFGF-W		UTG-UFGF-W		
Connection Pipe Diameter	Liquid/Gas	mm	6.35/9.52		6.35/9.52		6.35/12.70		

Medium Static Pressure Duct



Model name	Indoor unit		ARXG22KMLB			
kW Class	kW		6.0			
Power Source	Single phase, ~230 V, 50 Hz					
Sound Pressure Level	Cooling	H/M/L/Q	dB(A)	31/29/27/25		
	Heating			31/29/27/25		
Sound Power Level	Cooling	H	dB(A)	60		
	Heating			62		
Airflow Rate	Cooling	H/M/L/Q	m³/h	1,100/910/750/580		
	Heating			1,100/910/750/580		
Net Dimensions	mm		270 × 1,135 × 700			
Weight	kg		35			
Connection Pipe Diameter	Liquid/Gas	mm	6.35/12.70			
External static pressure	Pa		30 to 150			
Drain pump			Option			

Mini duct

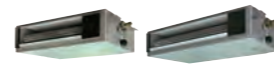

Model name	Indoor unit		ARXG07KSLAP	ARXG09KSLAP	ARXG12KSLAP	ARXG14KSLAP	ARXG18KSLAP	
kW Class	kW		2.0	2.5	3.5	4.0	5.0	
Power Source	Single phase, ~230 V, 50 Hz							
Sound Pressure Level	Cooling	H/M/L/Q	dB(A)	29/26/24/23	29/26/24/23	31/27/25/23	35/30/27/23	33/29/26/23
	Heating			29/26/24/23	29/26/24/23	31/27/25/23	35/30/27/23	33/29/26/23
Sound Power Level	Cooling	H	dB(A)	52	54	55	60	58
	Heating			53	56	57	62	59
Airflow Rate	Cooling	H/M/L/Q	m³/h	550/440/390/360	600/450/400/360	650/490/430/360	800/640/530/360	940/750/540/480
	Heating			550/440/390/360	600/450/400/360	650/490/430/360	800/640/530/360	940/750/540/480
Net Dimensions	mm		198 × 700 × 450		198 × 700 × 450		198 × 900 × 450	
Weight	kg		15.5		15.5		18.5	
Connection Pipe Diameter	Liquid/Gas	mm	6.35/9.52		6.35/9.52		6.35/12.70	
External static pressure	Pa		0 to 30		0 to 30		0 to 50	
Drain pump			Standard		Standard		Standard	

Slim duct



Model name	Indoor unit		ARXG07KLLAP	ARXG09KLLAP	ARXG12KLLAP	ARXG14KLLAP	ARXG18KLLAP	
kW Class	kW		2.0	2.5	3.5	4.0	5.0	
Power Source	Single phase, ~230 V, 50 Hz							
Sound Pressure Level	Cooling	H/M/L/Q	dB(A)	28/26/25/24	28/27/26/25	29/28/27/26	32/30/28/26	32/30/29/27
	Heating			28/26/25/24	28/26/25/24	29/28/27/24	32/30/28/25	32/30/29/27
Sound Power Level	Cooling	H	dB(A)	57	57	58	60	58
	Heating			57	57	58	60	58
Airflow Rate	Cooling	H/M/L/Q	m³/h	550/490/470/440	600/550/500/450	650/600/550/480	800/700/600/480	940/880/820/750
	Heating			550/490/470/440	600/550/500/450	650/600/550/480	800/700/600/480	940/880/820/750
Net Dimensions	mm		198 × 700 × 620		198 × 700 × 620		198 × 900 × 620	
Weight	kg		16		17		20	
Connection Pipe Diameter	Liquid/Gas	mm	6.35/9.52		6.35/9.52		6.35/12.70	
External static pressure	Pa		0 to 90		0 to 90		0 to 90	
Drain pump			Standard		Standard		Standard	

Medium Static Pressure Duct



Model name	Indoor unit		ARXH12KMTAP	ARXH14KMTAP	ARXH18KMTAP	ARXH22KMTAP		
kW Class	kW		3.5	4.0	5.0	6.0		
Power Source	Single-phase, ~230V, 50Hz							
Sound Pressure Level	Cooling	H/M/L/Q	dB(A)	29 / 27 / 25 / 23	32 / 29 / 27 / 25	33 / 30 / 28 / 26	32/28/25/24	
	Heating			29 / 27 / 25 / 23	32 / 29 / 27 / 25	33 / 30 / 28 / 26	32/28/25/24	
Sound Power Level	Cooling	H	dB(A)	58	59	60	58	
	Heating			58	59	60	58	
Airflow Rate	Cooling	H/M/L/Q	m³/h	650 / 520 / 460 / 390	800 / 640 / 560 / 480	840 / 720 / 630 / 540	1,150 / 920 / 800 / 700	
	Heating			650 / 520 / 460 / 390	800 / 640 / 560 / 480	840 / 720 / 630 / 540	1,150 / 920 / 800 / 700	
Net Dimensions	mm		240 × 700 × 700		240 × 700 × 700		240 × 1,000 × 700	
Weight	kg		24		24		31	
Connection Pipe Diameter	Liquid/Gas	mm	6.35 / 9.52		6.35 / 12.7		6.35/12.70	
External static pressure	Pa		30 to 150		30 to 150		30 to 150	
Drain pump			Standard		Standard		Standard	



6-unit Multi-Split Indoor Units Specifications

Compact wall-mounted



Model name	Indoor unit			ASHG07LUCA	ASHG09LUCA	ASHG12LUCA	ASHG14LUCA
kW Class	kW			2.0	2.5	3.5	4.0
Power Source	Single phase, ~230 V, 50 Hz						
Sound Pressure Level	Cooling	H/M/L/Q	dB(A)	35/30/28/21	36/32/28/21	37/34/31/21	41/36/33/25
	Heating			35/30/28/21	36/32/28/21	37/34/31/21	41/36/34/27
Sound Power Level	Cooling	H	dB(A)	53	54	55	59
	Heating			53	54	55	59
Airflow Rate	Cooling	H/M/L/Q	m³/h	570/520/470/330	600/550/470/330	660/600/530/330	710/640/570/390
	Heating			570/520/470/330	600/550/470/330	660/600/530/330	710/640/590/430
Net Dimensions	mm			282 × 870 × 185	282 × 870 × 185	282 × 870 × 185	282 × 870 × 185
Weight	kg			9.5	9.5	9.5	9.5
Connection Pipe Diameter	Liquid/Gas	mm		6.35/9.52	6.35/9.52	6.35/9.52	6.35/12.70

Wall-mounted



Model name	Indoor unit			ASHG18LFCA	ASHG24LFCC
kW Class	kW			5.0	7.0
Power Source	Single phase, ~230 V, 50 Hz				
Sound Pressure Level	Cooling	H/M/L/Q	dB(A)	43/37/33/26	49/42/37/33
	Heating			42/37/33/25	48/42/37/33
Sound Power Level	Cooling	H	dB(A)	58	64
	Heating			58	64
Airflow Rate	Cooling	H/M/L/Q	m³/h	900/740/620/550	1,120/900/740/620
	Heating			900/740/620/550	1,100/900/740/620
Net Dimensions	mm			320 × 998 × 238	320 × 998 × 238
Weight	kg			14	14
Connection Pipe Diameter	Liquid/Gas	mm		6.35/12.70	6.35/15.88

Compact wall-mounted



Model name	Indoor unit			ASHG07LMCA	ASHG09LMCA	ASHG12LMCA	ASHG14LMCA
kW Class	kW			2.0	2.5	3.5	4.0
Power Source	Single phase, ~230 V, 50 Hz						
Sound Pressure Level	Cooling	H/M/L/Q	dB(A)	36/32/29/21	37/33/29/21	40/36/30/21	42/38/33/25
	Heating			36/32/29/22	37/33/29/22	40/36/31/22	42/38/35/27
Sound Power Level	Cooling	H	dB(A)	51	52	54	56
	Heating			51	52	55	57
Airflow Rate	Cooling	H/M/L/Q	m³/h	560/500/430/310	600/520/430/310	660/560/450/310	730/600/530/360
	Heating			560/500/430/330	600/520/430/330	660/560/470/330	730/615/560/375
Net Dimensions	mm			268 × 840 × 203	268 × 840 × 203	268 × 840 × 203	268 × 840 × 203
Weight	kg			8.5	8.5	8.5	8.5
Connection Pipe Diameter	Liquid/Gas	mm		6.35/9.52	6.35/9.52	6.35/9.52	6.35/12.70

Floor



Model name	Indoor unit			AGHG09LVCA	AGHG12LVCA	AGHG14LVCA
kW Class	kW			2.5	3.5	4.0
Power Source	Single phase, ~230 V, 50 Hz					
Sound Pressure Level	Cooling	H/M/L/Q	dB(A)	39/34/28/22	42/36/30/22	44/38/31/22
	Heating			39/35/30/22	42/38/32/22	44/39/33/22
Sound Power Level	Cooling	H	dB(A)	52	55	56
	Heating			52	55	56
Airflow Rate	Cooling	H/M/L/Q	m³/h	530/440/360/270	600/490/380/270	650/520/400/270
	Heating			530/460/380/270	600/510/410/270	650/540/430/270
Net Dimensions	mm			600 × 740 × 200	600 × 740 × 200	600 × 740 × 200
Weight	kg			14	14	14
Connection Pipe Diameter	Liquid/Gas	mm		6.35/9.52	6.35/9.52	6.35/12.70

Floor ceiling



Model name	Indoor unit			ABHG14LVTA	ABHG18LVTB
kW Class	kW			4.0	5.0
Power Source	Single phase, ~230 V, 50 Hz				
Sound Pressure Level	Cooling	H/M/L/Q	dB(A)	36/34/33/29 (Under ceiling) 39/37/36/32 (Floor console)	41/38/34/32 (Under ceiling) 44/41/37/35 (Floor console)
	Heating			36/34/33/29 (Under ceiling) 39/37/36/32 (Floor console)	41/38/34/32 (Under ceiling) 44/41/37/35 (Floor console)
Sound Power Level	Cooling	H	dB(A)	51	55
	Heating			51	55
Airflow Rate	Cooling	H/M/L/Q	m³/h	640/590/540/480	780/700/560/500
	Heating			640/590/540/480	780/700/560/500
Net Dimensions	mm			199 × 990 × 655	199 × 990 × 655
Weight	kg			27	27
Connection Pipe Diameter	Liquid/Gas	mm		6.35/12.70	6.35/12.70

Compact cassette



Model name	Indoor unit			AUHG07LVLA	AUHG09LVLA	AUHG12LVLB	AUHG14LVLB	AUHG18LVLB
kW Class	kW			2.0	2.5	3.5	4.0	5.0
Power Source	Single phase, ~230 V, 50 Hz							
Sound Pressure Level	Cooling	H/M/L/Q	dB(A)	33/31/29/27	33/31/29/27	37/33/31/28	40/35/32/29	42/37/33/29
	Heating			34/32/29/27	34/32/29/27	37/33/31/28	40/37/34/29	44/40/37/30
Sound Power Level	Cooling	H	dB(A)	46	46	49	52	54
	Heating			47	47	49	52	56
Airflow Rate	Cooling	H/M/L/Q	m³/h	540/490/440/390	540/490/440/390	610/530/470/410	680/580/490/410	750/610/520/410
	Heating			540/490/440/390	540/490/440/390	610/530/470/410	700/620/550/430	800/710/600/450
Net Dimensions	mm			245 × 570 × 570	245 × 570 × 570	245 × 570 × 570	245 × 570 × 570	245 × 570 × 570
Weight	kg			15	15	15	15	15
Panel	UTG-UFGD-W							
Connection Pipe Diameter	Liquid/Gas	mm		6.35/9.52	6.35/9.52	6.35/9.52	6.35/12.70	6.35/12.70

Mini duct



Model name	Indoor unit			ARHG07LSLAP	ARHG09LSLAP	ARHG12LSLAP	ARHG14LSLAP	ARHG18LSLAP
kW Class	kW			2.0	2.5	3.5	4.0	5.0
Power Source	Single phase, ~230 V, 50 Hz							
Sound Pressure Level	Cooling	H/M/L/Q	dB(A)	29/26/24/23	29/26/24/23	31/27/25/23	35/30/27/23	33/29/26/23
	Heating			29/26/24/23	29/26/24/23	31/27/25/23	35/30/27/23	33/29/26/23
Sound Power Level	Cooling	H	dB(A)	52	54	55	60	58
	Heating			53	56	57	62	59
Airflow Rate	Cooling	H/M/L/Q	m³/h	550/440/390/360	600/450/400/360	650/490/430/360	800/640/530/360	940/750/540/480
	Heating			550/440/390/360	600/450/400/360	650/490/430/360	800/640/530/360	940/750/540/480
Net Dimensions	mm			198 × 700 × 450	198 × 700 × 450	198 × 700 × 450	198 × 700 × 450	198 × 900 × 450
Weight	kg			15.5				18.5
Connection Pipe Diameter	Liquid/Gas	mm		6.35/9.52			6.35/12.70	
External static pressure	Pa			0 to 30			0 to 50	
Drain pump	Standard							

Slim duct

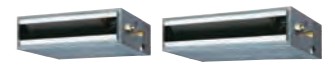

Model name	Indoor unit			ARHG07LLTA	ARHG09LLTA	ARHG12LLTB	ARHG14LLTB	ARHG18LLTB
kW Class	kW			2.0	2.5	3.5	4.0	5.0
Power Source	Single phase, ~230 V, 50 Hz							
Sound Pressure Level	Cooling	H/M/L/Q	dB(A)	28/26/25/24	28/27/26/25	29/28/27/26	32/30/28/26	32/31/30/29
	Heating			28/26/25/24	28/26/25/24	29/28/27/24	33/30/28/25	33/32/31/29
Sound Power Level	Cooling	H	dB(A)	57	57	58	60	58
	Heating			57	57	58	61	59
Airflow Rate	Cooling	H/M/L/Q	m³/h	550/490/470/440	600/550/500/450	650/600/550/480	800/700/600/480	940/880/820/750
	Heating			550/490/470/440	600/550/500/450	650/600/550/480	800/700/600/480	940/880/820/750
Net Dimensions	mm			198 × 700 × 620	198 × 700 × 620	198 × 700 × 620	198 × 700 × 620	198 × 900 × 620
Weight	kg			17	19	19	19	23
Connection Pipe Diameter	Liquid/Gas	mm		6.35/9.52	6.35/9.52	6.35/9.52	6.35/12.7	6.35/12.70
External static pressure	Pa			0 to 90				
Drain pump	Standard							

2-unit Multi-Split (Eco range) Combination Table–Cooling/Heating

The data in the table below shows the performance of various combinations of indoor and outdoor units of different capacities, using the most efficient type of indoor unit. These values should not be interpreted as official declarations for tax incentives or other certifications. For more information on specific types of indoor and outdoor unit combinations, please refer to the Design & Technical Manual.

2-unit Multi-split cooling

AOHH14KACB2	Combination of Indoor Units		Cooling Operation				Seasonal Data			
			Cooling Capacity			Input Power (Min. - Max.) kW	EER	Pdesign kW	SEER	Energy efficiency class
			Unit 1 kW	Unit 2 kW	Total Capacity (Min. - Max.) kW					
2-unit connection	7	7	2.00	2.00	4.00 (1.40-4.40)	1.02 (0.25-1.25)	3.92	4.00	7.90	A++
	7	9	1.70	2.30	4.00 (1.40-4.40)	1.02 (0.25-1.25)	3.92	4.00	7.90	A++
	7	12	1.50	2.50	4.00 (1.40-4.40)	1.02 (0.25-1.25)	3.92	4.00	7.90	A++
	9	9	2.00	2.00	4.00 (1.40-4.40)	1.02 (0.25-1.25)	3.92	4.00	7.90	A++
	9	12	1.70	2.30	4.00 (1.40-4.40)	1.02 (0.25-1.25)	3.92	4.00	7.90	A++

Notes: •7: 7000 Btu/h/9: 9000 Btu/h/12: 12000 Btu/h models
 •2 or more indoor units should be connected.
 •Cooling capacity is determined based on 27°CDB/19°CWB (indoor temperature) and 35°CDB (outdoor temperature).
 •Pipe Length: 5 m, Height difference: 0 m (Outdoor unit to Indoor unit)
 •Total capacity of indoor units connected must be between 14000Btu/h and 21000Btu/h.

AOHH18KACB2	Combination of Indoor Units		Cooling Operation				Seasonal Data			
			Cooling Capacity			Input Power (Min. - Max.) kW	EER	Pdesign kW	SEER	Energy efficiency class
			Unit 1 kW	Unit 2 kW	Total Capacity (Min. - Max.) kW					
2-unit connection	7	7	2.00	2.00	4.00 (1.40-4.40)	1.00 (0.25-1.15)	4.00	4.00	8.10	A++
	7	9	2.00	2.50	4.50 (1.40-4.80)	1.21 (0.25-1.35)	3.72	4.50	8.00	A++
	7	12	2.00	3.00	5.00 (1.40-5.20)	1.47 (0.25-1.63)	3.40	5.00	7.90	A++
	9	9	2.50	2.50	5.00 (1.40-5.20)	1.47 (0.25-1.63)	3.40	5.00	7.90	A++
	9	12	2.10	2.90	5.00 (1.40-5.20)	1.47 (0.25-1.63)	3.40	5.00	7.90	A++
	12	12	2.50	2.50	5.00 (1.40-5.20)	1.47 (0.25-1.63)	3.40	5.00	7.90	A++

Notes: •7: 7000 Btu/h/9:9000 Btu/h/12: 12000 Btu/h models
 •2 or more indoor units should be connected.
 •Cooling capacity is determined based on 27°CDB/19°CWB (indoor temperature) and 35°CDB (outdoor temperature).
 •Pipe Length: 5 m, Height difference: 0 m (Outdoor unit to Indoor unit)
 •Total capacity of indoor units connected must be between 14000Btu/h and 24000Btu/h.

2-unit Multi-split heating

AOHH14KACB2	Combination of Indoor Units		Heating Operation				Seasonal Data			
			Heating Capacity			Input Power (Min. - Max.) kW	COP	Pdesign kW	SCOP	Energy efficiency class
			Unit 1 kW	Unit 2 kW	Total Capacity (Min. - Max.) kW					
2-unit connection	7	7	2.10	2.10	4.20 (1.10-4.80)	0.97 (0.25-1.40)	4.33	3.30	4.30	A+
	7	9	1.80	2.40	4.20 (1.10-4.80)	0.97 (0.25-1.40)	4.33	3.30	4.30	A+
	7	12	1.50	2.70	4.20 (1.10-4.80)	0.97 (0.25-1.40)	4.33	3.30	4.30	A+
	9	9	2.10	2.10	4.20 (1.10-4.80)	0.97 (0.25-1.40)	4.33	3.30	4.30	A+
	9	12	1.80	2.40	4.20 (1.10-4.80)	0.97 (0.25-1.40)	4.33	3.30	4.30	A+

Notes: •7: 7000 Btu/h/9: 9000 Btu/h/12: 12000 Btu/h models
 •2 or more indoor units should be connected.
 •Heating capacity is determined based on 20°CDB (indoor temperature) and 7°CDB/6°CWB (outdoor temperature).
 •Pipe Length: 5 m, Height difference: 0 m (Outdoor unit to Indoor unit)
 •Total capacity of indoor units connected must be between 14000Btu/h and 21000Btu/h.

AOHH18KACB2	Combination of Indoor Units		Heating Operation				Seasonal Data			
			Heating Capacity			Input Power (Min. - Max.) kW	COP	Pdesign kW	SCOP	Energy efficiency class
			Unit 1 kW	Unit 2 kW	Total Capacity (Min. - Max.) kW					
2-unit connection	7	7	2.30	2.30	4.60 (1.10-5.60)	1.04 (0.25-1.52)	4.33	3.30	4.30	A+
	7	9	2.30	3.00	5.30 (1.10-6.00)	1.43 (0.25-1.80)	3.71	3.30	4.30	A+
	7	12	2.00	3.30	5.30 (1.10-6.00)	1.42 (0.25-1.80)	3.73	3.50	4.30	A+
	9	9	2.65	2.65	5.30 (1.10-6.00)	1.42 (0.25-1.80)	3.73	3.50	4.30	A+
	9	12	2.30	3.00	5.30 (1.10-6.00)	1.42 (0.25-1.80)	3.73	3.50	4.30	A+
	12	12	2.65	2.65	5.30 (1.10-6.00)	1.42 (0.25-1.80)	3.73	3.50	4.30	A+

Notes: •7: 7000 Btu/h/9:9000 Btu/h/12: 12000 Btu/h models
 •2 or more indoor units should be connected.
 •Heating capacity is determined based on 20°CDB (indoor temperature) and 7°CDB/6°CWB (outdoor temperature).
 •Pipe Length: 5 m, Height difference: 0 m (Outdoor unit to Indoor unit)
 •Total capacity of indoor units connected must be between 14000Btu/h and 24000Btu/h.



3-unit Multi-Split (Eco range) Combination Table–Cooling/Heating



The data in the table below shows the performance of various combinations of indoor and outdoor units of different capacities, using the most efficient type of indoor unit. These values should not be interpreted as official declarations for tax incentives or other certifications. For more information on specific types of indoor and outdoor unit combinations, please refer to the Design & Technical Manual.

3-unit Multi-split cooling

AOHH18KACB3	Combination of Indoor Units			Cooling Operation					Seasonal Data			
				Cooling Capacity				Input Power (Min. - Max.)	EER	Pdesign kW	SEER	Energy efficiency
				Unit 1 kW	Unit 2 kW	Unit 3 kW	Total Capacity (Min. - Max.) kW					
2-unit connection	7	7	-	2.00	2.00	-	4.00 (1.80-4.40)	0.94 (0.27-1.04)	4.26	4.00	8.00	A++
	7	9	-	2.00	2.50	-	4.50 (1.80-4.80)	1.10 (0.27-1.19)	4.09	4.50	8.00	A++
	7	12	-	2.00	3.20	-	5.20 (1.80-5.40)	1.36 (0.27-1.41)	3.83	5.20	7.70	A++
	9	9	-	2.50	2.50	-	5.00 (1.80-5.20)	1.25 (0.27-1.36)	4.00	5.00	7.90	A++
	9	12	-	2.20	3.00	-	5.20 (1.80-5.80)	1.36 (0.27-1.60)	3.83	5.20	7.70	A++
	12	12	-	2.65	2.65	-	5.30 (1.80-6.40)	1.44 (0.27-1.89)	3.68	5.30	7.70	A++
3-unit connection	7	7	7	1.77	1.77	1.77	5.30 (1.80-6.60)	1.27 (0.27-1.91)	4.17	5.30	7.90	A++
	7	7	9	1.60	1.60	2.10	5.30 (1.80-6.60)	1.27 (0.27-1.91)	4.17	5.30	7.90	A++
	7	7	12	1.43	1.43	2.45	5.30 (1.80-6.60)	1.27 (0.27-1.91)	4.17	5.30	7.90	A++
	7	9	9	1.50	1.90	1.90	5.30 (1.80-6.60)	1.27 (0.27-1.91)	4.17	5.30	7.90	A++
	7	9	12	1.30	1.70	2.30	5.30 (1.80-6.60)	1.27 (0.27-1.91)	4.17	5.30	7.90	A++
	9	9	9	1.77	1.77	1.77	5.30 (1.80-6.60)	1.27 (0.27-1.91)	4.17	5.30	7.90	A++
	9	9	12	1.60	1.60	2.10	5.30 (1.80-6.60)	1.27 (0.27-1.91)	4.17	5.30	7.90	A++

Notes: •7: 7000 Btu/h/9: 9000 Btu/h/12: 12000 Btu/h models
 •2 or more indoor units should be connected.
 •Cooling capacity is determined based on 27°CDB/19°CWB (indoor temperature) and 35°CDB (outdoor temperature).
 •Pipe Length: 5 m, Height difference: 0 m (Outdoor unit to Indoor unit)
 •Total capacity of indoor units connected must be between 14000Btu/h and 30000Btu/h.

3-unit Multi-split heating

AOHH18KACB3	Combination of Indoor Units			Heating Operation					Seasonal Data			
				Heating Capacity				Input Power (Min. - Max.)	COP	Pdesign kW	SCOP	Energy efficiency
				Unit 1 kW	Unit 2 kW	Unit 3 kW	Total Capacity (Min. - Max.) kW					
2-unit connection	7	7	-	2.40	2.40	-	4.80 (1.70-5.60)	1.11 (0.25-1.64)	4.32	3.80	4.20	A+
	7	9	-	2.40	3.00	-	5.40 (1.70-6.40)	1.35 (0.25-2.04)	4.00	3.80	4.20	A+
	7	12	-	2.30	3.90	-	6.20 (1.70-7.20)	1.67 (0.25-2.27)	3.71	4.30	4.20	A+
	9	9	-	3.00	3.00	-	6.00 (1.70-7.20)	1.58 (0.25-2.27)	3.80	4.30	4.20	A+
	9	12	-	2.70	3.50	-	6.20 (1.70-8.00)	1.67 (0.25-2.35)	3.71	4.30	4.20	A+
	12	12	-	3.20	3.20	-	6.40 (1.70-7.80)	1.73 (0.25-2.35)	3.71	4.50	4.10	A+
3-unit connection	7	7	7	2.13	2.13	2.13	6.40 (1.70-7.80)	1.48 (0.25-2.35)	4.32	5.00	4.30	A+
	7	7	9	1.95	1.95	2.50	6.40 (1.70-7.80)	1.48 (0.25-2.35)	4.32	5.00	4.30	A+
	7	7	12	1.72	1.72	2.95	6.40 (1.70-7.80)	1.48 (0.25-2.35)	4.32	5.00	4.30	A+
	7	9	9	1.79	2.30	2.30	6.40 (1.70-7.80)	1.48 (0.25-2.35)	4.32	5.00	4.30	A+
	7	9	12	1.60	2.10	2.70	6.40 (1.70-7.80)	1.48 (0.25-2.35)	4.32	5.00	4.30	A+
	9	9	9	2.13	2.13	2.13	6.40 (1.70-7.80)	1.48 (0.25-2.35)	4.32	5.00	4.30	A+
	9	9	12	1.90	1.90	2.60	6.40 (1.70-7.80)	1.48 (0.25-2.35)	4.32	5.00	4.30	A+

Notes: •7: 7000 Btu/h/9: 9000 Btu/h/12: 12000 Btu/h models
 •2 or more indoor units should be connected.
 •Heating capacity is determined based on 20°CDB (indoor temperature) and 7°CDB/6°CWB (outdoor temperature).
 •Pipe Length: 5 m, Height difference: 0 m (Outdoor unit to Indoor unit)
 Total capacity of indoor units connected must be between 14000Btu/h and 30000Btu/h.

2-unit Multi-Split Combination Table—Cooling/Heating

The data in the table below shows the performance of various combinations of indoor and outdoor units of different capacities, using the most efficient type of indoor unit. These values should not be interpreted as official declarations for tax incentives or other certifications. For more information on specific types of indoor and outdoor unit combinations, please refer to the Design & Technical Manual.

2-unit Multi-split cooling

AOHG14KBTA2	Combination of Indoor Units		Cooling Operation					Seasonal Data		
			Cooling Capacity			Input Power (Min. - Max.) kW	EER	Pdesign kW	SEER	Energy efficiency class
			Unit 1 kW	Unit 2 kW	Total Capacity (Min. - Max.) kW					
2-unit connection	5	5	1.50	1.50	3.00 (1.40-3.60)	0.74 (0.25-0.95)	4.03	3.0	6.8	A++
	5	7	1.50	2.00	3.50 (1.40-4.30)	0.84 (0.25-1.10)	4.15	3.5	6.8	A++
	5	9	1.50	2.50	4.00 (1.40-4.39)	1.07 (0.25-1.25)	3.75	4.0	6.8	A++
	5	12	1.18	2.82	4.00 (1.40-4.61)	1.02 (0.25-1.25)	3.92	4.0	6.8	A++
	7	7	2.00	2.00	4.00 (1.40-4.60)	0.97 (0.25-1.20)	4.12	4.0	8.7	A+++
	7	9	1.75	2.25	4.00 (1.40-4.60)	0.97 (0.25-1.20)	4.12	4.0	8.7	A+++
	7	12	1.47	2.53	4.00 (1.40-4.60)	0.97 (0.25-1.20)	4.12	4.0	8.7	A+++
	9	9	2.00	2.00	4.00 (1.40-4.60)	0.97 (0.25-1.20)	4.12	4.0	8.7	A+++
	9	12	1.71	2.29	4.00 (1.40-4.60)	0.97 (0.25-1.20)	4.12	4.0	8.7	A+++

Notes: •5: 5000 Btu/h/7: 7000 Btu/h/9: 9000 Btu/h/12: 12000 Btu/h models
 •The above specifications are listed with the best combination of values selected.
 •2 or more indoor units should be connected.
 •Cooling capacity is determined based on 27°CDB/19°CWB (indoor temperature) and 35°CDB (outdoor temperature).
 •Pipe Length: 5 m, Height difference: 0 m (Outdoor unit to Indoor unit)
 •Total capacity of indoor units connected must be between 10000Btu/h and 21000Btu/h.
 •For compatible Outer Units with 5,000BTU models, please refer to the Design & Technical Manual Part. 1-1

AOHG18KBTA2	Combination of Indoor Units		Cooling Operation					Seasonal Data		
			Cooling Capacity			Input Power (Min. - Max.) kW	EER	Pdesign kW	SEER	Energy efficiency class
			Unit 1 kW	Unit 2 kW	Total Capacity (Min. - Max.) kW					
2-unit connection	5	5	1.50	1.50	3.00 (1.70-3.60)	0.53 (0.25-0.94)	5.65	3.0	6.9	A++
	5	7	1.50	2.00	3.50 (1.70-4.30)	0.75 (0.25-1.12)	4.65	3.5	6.9	A++
	5	9	1.50	2.50	4.00 (1.70-5.00)	0.97 (0.25-1.29)	4.10	4.0	6.9	A++
	5	12	1.41	3.39	4.80 (1.70-5.70)	1.20 (0.25-1.58)	4.00	5.0	6.7	A++
	5	14	1.32	3.68	5.00 (1.70-5.80)	1.32 (0.25-1.63)	3.78	5.0	6.7	A++
	7	7	2.00	2.00	4.00 (1.70-5.00)	0.92 (0.25-1.23)	4.35	4.0	8.8	A+++
	7	9	2.00	2.50	4.50 (1.70-5.70)	1.07 (0.25-1.45)	4.22	4.5	8.7	A+++
	7	12	1.84	3.16	5.00 (1.70-5.80)	1.24 (0.25-1.55)	4.03	5.0	8.6	A+++
	7	14	1.67	3.33	5.00 (1.70-5.80)	1.24 (0.25-1.55)	4.03	5.0	8.6	A+++
	9	9	2.50	2.50	5.00 (1.70-5.80)	1.24 (0.25-1.55)	4.03	5.0	8.6	A+++
	9	12	2.14	2.86	5.00 (1.70-5.80)	1.24 (0.25-1.55)	4.03	5.0	8.6	A+++
	9	14	1.96	3.04	5.00 (1.70-5.80)	1.24 (0.25-1.55)	4.03	5.0	8.6	A+++
	12	12	2.50	2.50	5.00 (1.70-5.80)	1.24 (0.25-1.55)	4.03	5.0	8.6	A+++
	12	14	2.31	2.69	5.00 (1.70-5.80)	1.24 (0.25-1.55)	4.03	5.0	8.6	A+++

Notes: •5: 5000 Btu/h/7: 7000 Btu/h/9:9000 Btu/h/12: 12000 Btu/h/14: 14000 Btu/h models
 •The above specifications are listed with the best combination of values selected.
 •2 or more indoor units should be connected.
 •Cooling capacity is determined based on 27°CDB/19°CWB (indoor temperature) and 35°CDB (outdoor temperature).
 •Pipe Length: 5 m, Height difference: 0 m (Outdoor unit to Indoor unit)
 •Total capacity of indoor units connected must be between 10000Btu/h and 26000Btu/h.
 •For compatible Outer Units with 5,000BTU models, please refer to the Design & Technical Manual Part. 1-1

2-unit Multi-split heating

AOHG14KBTA2	Combination of Indoor Units		Heating Operation					Seasonal Data		
			Heating Capacity			Input Power (Min. - Max.) kW	COP	Pdesign kW	SCOP	Energy efficiency class
			Unit 1 kW	Unit 2 kW	Total Capacity (Min. - Max.) kW					
2-unit connection	5	5	1.80	1.80	3.60 (1.10-4.20)	0.80 (0.25-1.25)	4.52	2.9	4.08	A+
	5	7	1.67	2.33	4.00 (1.10-4.80)	0.92 (0.25-1.50)	4.36	3.4	4.1	A+
	5	9	1.57	2.83	4.40 (1.10-5.10)	1.06 (0.25-1.70)	4.16	3.5	4.1	A+
	5	12	1.29	3.11	4.40 (1.10-5.40)	1.01 (0.25-1.70)	4.34	3.5	4.1	A+
	7	7	2.20	2.20	4.40 (1.10-5.50)	0.95 (0.25-1.65)	4.63	3.5	4.7	A++
	7	9	1.92	2.48	4.40 (1.10-5.50)	0.95 (0.25-1.65)	4.63	3.5	4.7	A++
	7	12	1.62	2.78	4.40 (1.10-5.50)	0.95 (0.25-1.65)	4.63	3.5	4.7	A++
	9	9	2.20	2.20	4.40 (1.10-5.50)	0.95 (0.25-1.65)	4.63	3.5	4.7	A++
	9	12	1.89	2.51	4.40 (1.10-5.50)	0.95 (0.25-1.65)	4.63	3.5	4.7	A++

Notes: •5: 5000 Btu/h/7: 7000 Btu/h/9: 9000 Btu/h/12: 12000 Btu/h models
 •The above specifications are listed with the best combination of values selected.
 •2 or more indoor units should be connected.
 •Heating capacity is determined based on 20°CDB (indoor temperature) and 7°CDB/6°CWB (outdoor temperature).
 •Pipe Length: 5 m, Height difference: 0 m (Outdoor unit to Indoor unit)
 •Total capacity of indoor units connected must be between 10000Btu/h and 21000Btu/h.
 •For compatible Outer Units with 5,000BTU models, please refer to the Design & Technical Manual Part. 1-1

AOHG18KBTA2	Combination of Indoor Units		Heating Operation					Seasonal Data		
			Heating Capacity			Input Power (Min. - Max.) kW	COP	Pdesign kW	SCOP	Energy efficiency class
			Unit 1 kW	Unit 2 kW	Total Capacity (Min. - Max.) kW					
2-unit connection	5	5	1.80	1.80	3.60 (1.70-4.20)	0.80 (0.25-0.94)	4.50	2.9	4.1	A+
	5	7	1.80	2.40	4.20 (1.70-4.90)	0.92 (0.25-1.18)	4.54	3.4	4.1	A+
	5	9	1.80	3.00	4.80 (1.70-5.60)	1.05 (0.25-1.41)	4.57	3.8	4.1	A+
	5	12	1.59	3.81	5.40 (1.70-6.40)	1.24 (0.25-1.76)	4.36	4.2	4.0	A+
	5	14	1.47	4.13	5.60 (1.70-6.60)	1.30 (0.25-1.88)	4.30	4.2	4.0	A+
	7	7	2.40	2.40	4.80 (1.70-5.60)	0.99 (0.25-1.35)	4.85	3.8	4.7	A++
	7	9	2.40	3.00	5.40 (1.70-6.40)	1.15 (0.25-1.60)	4.70	4.0	4.7	A++
	7	12	2.06	3.54	5.60 (1.70-7.00)	1.22 (0.25-1.80)	4.59	4.2	4.7	A++
	7	14	1.87	3.73	5.60 (1.70-7.00)	1.22 (0.25-1.80)	4.59	4.2	4.7	A++
	9	9	2.80	2.80	5.60 (1.70-7.00)	1.22 (0.25-1.80)	4.59	4.2	4.7	A++
	9	12	2.40	3.20	5.60 (1.70-7.00)	1.22 (0.25-1.80)	4.59	4.2	4.7	A++
	9	14	2.19	3.41	5.60 (1.70-7.00)	1.22 (0.25-1.80)	4.59	4.2	4.7	A++
	12	12	2.80	2.80	5.60 (1.70-7.00)	1.22 (0.25-1.80)	4.59	4.2	4.7	A++
	12	14	2.58	3.02	5.60 (1.70-7.00)	1.22 (0.25-1.80)	4.59	4.2	4.7	A++

Notes: •5: 5000 Btu/h/7: 7000 Btu/h/9:9000 Btu/h/12: 12000 Btu/h/14: 14000 Btu/h models
 •The above specifications are listed with the best combination of values selected.
 •2 or more indoor units should be connected.
 •Heating capacity is determined based on 20°CDB (indoor temperature) and 7°CDB/6°CWB (outdoor temperature).
 •Pipe Length: 5 m, Height difference: 0 m (Outdoor unit to Indoor unit)
 •Total capacity of indoor units connected must be between 10000Btu/h and 26000Btu/h.
 •For compatible Outer Units with 5,000BTU models, please refer to the Design & Technical Manual Part. 1-1



MULTI-SPLIT

3-unit Multi-Split Combination Table-cooling / Heating



The data in the table below shows the performance of various combinations of indoor and outdoor units of different capacities, using the most efficient type of indoor unit. These values should not be interpreted as official declarations for tax incentives or other certifications. For more information on specific types of indoor and outdoor unit combinations, please refer to the Design & Technical Manual.

3-unit Multi-split cooling

Table for 3-unit Multi-split cooling. Columns include AOHG18KBT A3, Combination of Indoor Units, Cooling Capacity (Unit 1, Unit 2, Unit 3, Total Capacity), Input Power, EER, Pdesign, SEER, and Energy efficiency. Rows are categorized by 2-unit and 3-unit connections.

Table for AOHG24KBT A3 3-unit Multi-split cooling. Columns include AOHG24KBT A3, Combination of Indoor Units, Cooling Capacity (Unit 1, Unit 2, Unit 3, Total Capacity), Input Power, EER, Pdesign, SEER, and Energy efficiency. Rows are categorized by 2-unit and 3-unit connections.

Notes: *5: 5000 Btu/h/7: 7000 Btu/h/9: 9000 Btu/h/12: 12000 Btu/h/14: 14000 Btu/h/18: 18000 Btu/h models. *The above specifications are listed with the best combination of values selected. *2 or more indoor units should be connected. *Cooling capacity is determined based on 27°CDB/19°CWB (indoor temperature) and 35°CDB (outdoor temperature). *Pipe Length: 5 m, Height difference: 0 m (Outdoor unit to Indoor unit). *AOHG18KBT A3: Total capacity of indoor units connected must be between 14000Btu/h and 30000Btu/h. *AOHG24KBT A3: Total capacity of indoor units connected must be between 14000Btu/h and 36000Btu/h. *For compatible Outer Units with 5,000BTU models, please refer to the Design & Technical Manual Part. 1-1

3-unit Multi-split heating

Table for 3-unit Multi-split heating. Columns include AOHG18KBT A3, Combination of Indoor Units, Heating Capacity (Unit 1, Unit 2, Unit 3, Total Capacity), Input Power, COP, Pdesign, SCOP, and Energy efficiency. Rows are categorized by 2-unit and 3-unit connections.

Table for AOHG24KBT A3 3-unit Multi-split heating. Columns include AOHG24KBT A3, Combination of Indoor Units, Heating Capacity (Unit 1, Unit 2, Unit 3, Total Capacity), Input Power, COP, Pdesign, SCOP, and Energy efficiency. Rows are categorized by 2-unit and 3-unit connections.

Notes: *5: 5000 Btu/h/7: 7000 Btu/h/9: 9000 Btu/h/12: 12000 Btu/h/14: 14000 Btu/h/18: 18000 Btu/h models. *The above specifications are listed with the best combination of values selected. *2 or more indoor units should be connected. *Heating capacity is determined based on 20°CDB (indoor temperature) and 7°CDB/6°CWB (outdoor temperature). *Pipe Length: 5 m, Height difference: 0 m (Outdoor unit to Indoor unit). *AOHG18KBT A3: Total capacity of indoor units connected must be between 14000Btu/h and 30000Btu/h. *AOHG24KBT A3: Total capacity of indoor units connected must be between 14000Btu/h and 36000Btu/h. *For compatible Outer Units with 5,000BTU models, please refer to the Design & Technical Manual Part. 1-1

MULTI-SPLIT



5-unit Multi-Split Combination Table-cooling



The data in the table below shows the performance of various combinations of indoor and outdoor units of different capacities, using the most efficient type of indoor unit. These values should not be interpreted as official declarations for tax incentives or other certifications. For more information on specific types of indoor and outdoor unit combinations, please refer to the Design & Technical Manual.

5-unit Multi-split cooling

AOHG36KBTAS	Combination of Indoor Units					Cooling Operation					Seasonal Data						
						Cooling Capacity					Input Power (Min. - Max.)	EER	Pdesign	SEER	Energy efficiency		
						Unit 1	Unit 2	Unit 3	Unit 4	Unit 5						Total Capacity (Min. - Max.)	
4-unit connection	9	9	12	14	-	1.94	1.94	2.59	3.03	-	9.50 (3.00-11.00)	2.69 (0.30-3.45)	3.53	9.5	8.3	A++	
	9	9	12	18	-	1.78	1.78	2.38	3.56	-	9.50 (3.00-11.00)	2.69 (0.30-3.45)	3.53	9.5	8.3	A++	
	9	9	12	22	-	1.64	1.64	2.19	4.03	-	9.50 (3.00-11.00)	2.69 (0.30-3.45)	3.53	9.5	8.3	A++	
	9	9	12	24	-	1.58	1.58	2.11	4.23	-	9.50 (3.00-11.00)	2.69 (0.30-3.45)	3.53	9.5	8.3	A++	
	9	9	14	14	-	1.86	1.86	2.89	2.89	-	9.50 (3.00-11.00)	2.69 (0.30-3.45)	3.53	9.5	8.3	A++	
	9	9	14	18	-	1.71	1.71	2.65	3.42	-	9.50 (3.00-11.00)	2.69 (0.30-3.45)	3.53	9.5	8.3	A++	
	9	9	18	18	-	1.58	1.58	3.17	3.17	-	9.50 (3.00-11.00)	2.69 (0.30-3.45)	3.53	9.5	8.3	A++	
	9	12	12	12	-	1.91	2.53	2.53	2.53	-	9.50 (3.00-11.00)	2.69 (0.30-3.45)	3.53	9.5	8.3	A++	
	9	12	12	14	-	1.81	2.43	2.43	2.83	-	9.50 (3.00-11.00)	2.69 (0.30-3.45)	3.53	9.5	8.3	A++	
	9	12	12	18	-	1.67	2.24	2.24	3.35	-	9.50 (3.00-11.00)	2.69 (0.30-3.45)	3.53	9.5	8.3	A++	
	9	12	14	14	-	1.74	2.34	2.71	2.71	-	9.50 (3.00-11.00)	2.69 (0.30-3.45)	3.53	9.5	8.3	A++	
	9	12	14	18	-	1.61	2.15	2.51	3.23	-	9.50 (3.00-11.00)	2.69 (0.30-3.45)	3.53	9.5	8.3	A++	
	9	14	14	14	-	1.67	2.61	2.61	2.61	-	9.50 (3.00-11.00)	2.69 (0.30-3.45)	3.53	9.5	8.3	A++	
	12	12	12	12	-	2.38	2.38	2.38	2.38	-	9.50 (3.00-11.00)	2.69 (0.30-3.45)	3.53	9.5	8.3	A++	
	12	12	14	14	-	2.28	2.28	2.28	2.66	-	9.50 (3.00-11.00)	2.69 (0.30-3.45)	3.53	9.5	8.3	A++	
	12	12	18	18	-	2.11	2.11	2.11	3.17	-	9.50 (3.00-11.00)	2.69 (0.30-3.45)	3.53	9.5	8.3	A++	
	12	12	14	14	-	2.19	2.19	2.56	2.56	-	9.50 (3.00-11.00)	2.69 (0.30-3.45)	3.53	9.5	8.3	A++	
	12	14	14	14	-	2.12	2.46	2.46	2.46	-	9.50 (3.00-11.00)	2.69 (0.30-3.45)	3.53	9.5	8.3	A++	
	5-unit connection	5	5	5	5	7	1.39	1.39	1.39	1.94	1.94	7.50 (3.00-9.60)	1.72 (0.30-2.84)	4.35	8.5	6.6	A++
		5	5	5	5	9	1.38	1.38	1.38	2.48	2.48	8.00 (3.00-10.40)	1.92 (0.30-3.13)	4.17	9.5	6.5	A++
5		5	5	5	12	1.41	1.41	1.41	3.38	3.38	9.00 (3.00-11.00)	2.21 (0.30-3.46)	4.06	9.5	6.5	A++	
5		5	5	5	14	1.40	1.40	1.40	3.91	3.91	9.50 (3.00-11.00)	2.41 (0.30-3.46)	3.94	9.5	6.5	A++	
5		5	5	5	18	1.25	1.25	1.25	4.50	4.50	9.50 (3.00-11.00)	2.51 (0.30-3.46)	3.78	9.5	6.5	A++	
5		5	5	5	22	1.13	1.13	1.13	4.98	4.98	9.50 (3.00-11.00)	2.61 (0.30-3.46)	3.53	9.5	6.5	A++	
5		5	5	5	24	1.08	1.08	1.08	5.18	5.18	9.50 (3.00-11.00)	2.51 (0.30-3.46)	3.78	8.5	6.6	A++	
5		5	5	7	7	1.38	1.38	1.38	1.93	1.93	8.00 (3.00-10.40)	1.92 (0.30-3.13)	4.17	9.0	6.6	A++	
5		5	5	7	9	1.45	1.45	1.45	2.03	2.61	9.00 (3.00-11.00)	2.12 (0.30-3.46)	4.25	9.5	6.5	A++	
5		5	5	7	12	1.40	1.40	1.40	1.96	3.35	9.50 (3.00-11.00)	2.41 (0.30-3.46)	3.94	9.5	6.5	A++	
5		5	5	7	14	1.32	1.32	1.32	1.85	3.69	9.50 (3.00-11.00)	2.51 (0.30-3.46)	3.78	9.5	6.5	A++	
5		5	5	7	18	1.19	1.19	1.19	1.66	4.28	9.50 (3.00-11.00)	2.51 (0.30-3.46)	3.78	9.5	6.5	A++	
5		5	5	7	22	1.08	1.08	1.08	1.51	4.75	9.50 (3.00-11.00)	2.51 (0.30-3.46)	3.78	9.5	6.5	A++	
5		5	5	7	24	1.03	1.03	1.03	1.45	4.96	9.50 (3.00-11.00)	2.51 (0.30-3.46)	3.78	9.5	6.5	A++	
5		5	5	9	9	1.44	1.44	1.44	1.59	2.54	9.50 (3.00-11.00)	2.51 (0.30-3.46)	4.11	9.5	6.5	A++	
5		5	5	9	12	1.32	1.32	1.32	2.38	3.17	9.50 (3.00-11.00)	2.51 (0.30-3.46)	3.78	9.5	6.5	A++	
5		5	5	9	14	1.25	1.25	1.25	2.25	3.50	9.50 (3.00-11.00)	2.51 (0.30-3.46)	3.78	9.5	6.5	A++	
5		5	5	9	18	1.13	1.13	1.13	2.04	4.07	9.50 (3.00-11.00)	2.51 (0.30-3.46)	3.78	9.5	6.5	A++	
5		5	5	9	22	1.03	1.03	1.03	1.86	4.54	9.50 (3.00-11.00)	2.51 (0.30-3.46)	3.78	9.5	6.5	A++	
5		5	5	9	24	0.99	0.99	0.99	1.78	4.75	9.50 (3.00-11.00)	2.51 (0.30-3.46)	3.78	9.5	6.5	A++	
5		5	5	12	12	1.22	1.22	1.22	2.92	2.92	9.50 (3.00-11.00)	2.51 (0.30-3.46)	3.78	9.5	6.5	A++	
5		5	5	12	14	1.16	1.16	1.16	2.78	3.24	9.50 (3.00-11.00)	2.51 (0.30-3.46)	3.78	9.5	6.5	A++	
5		5	5	12	18	1.06	1.06	1.06	2.53	3.80	9.50 (3.00-11.00)	2.51 (0.30-3.46)	3.78	9.5	6.5	A++	
5		5	5	12	22	0.97	0.97	0.97	2.37	4.38	9.50 (3.00-11.00)	2.51 (0.30-3.46)	3.78	9.5	6.5	A++	
5		5	5	12	24	0.93	0.93	0.93	2.24	4.47	9.50 (3.00-11.00)	2.51 (0.30-3.46)	3.78	9.5	6.5	A++	
5		5	5	14	14	1.10	1.10	1.10	3.09	3.09	9.50 (3.00-11.00)	2.51 (0.30-3.46)	3.78	9.5	6.5	A++	
5		5	5	14	18	1.01	1.01	1.01	2.83	3.64	9.50 (3.00-11.00)	2.51 (0.30-3.46)	3.78	9.5	6.5	A++	
5		5	5	14	22	0.93	0.93	0.93	2.61	4.10	9.50 (3.00-11.00)	2.51 (0.30-3.46)	3.78	9.5	6.5	A++	
5		5	5	14	24	0.90	0.90	0.90	2.51	4.30	9.50 (3.00-11.00)	2.51 (0.30-3.46)	3.78	9.5	6.5	A++	
5		5	5	18	18	0.93	0.93	0.93	3.35	3.35	9.50 (3.00-11.00)	2.51 (0.30-3.46)	3.78	9.0	6.6	A++	
5		5	7	7	7	1.45	1.45	2.03	2.03	2.03	9.00 (3.00-11.00)	2.12 (0.30-3.46)	4.25	9.5	6.5	A++	
5		5	7	7	9	1.44	1.44	2.02	2.02	2.59	9.50 (3.00-11.00)	2.51 (0.30-3.46)	4.11	9.5	6.5	A++	
5		5	7	7	12	1.32	1.32	1.85	1.85	3.17	9.50 (3.00-11.00)	2.51 (0.30-3.46)	3.78	9.5	6.5	A++	
5		5	7	7	14	1.25	1.25	1.75	1.75	3.50	9.50 (3.00-11.00)	2.51 (0.30-3.46)	3.78	9.5	6.5	A++	
5		5	7	7	18	1.13	1.13	1.58	1.58	4.07	9.50 (3.00-11.00)	2.51 (0.30-3.46)	3.78	9.5	6.5	A++	
5		5	7	7	22	1.03	1.03	1.45	1.45	4.54	9.50 (3.00-11.00)	2.51 (0.30-3.46)	3.78	9.5	6.5	A++	
5		5	7	7	24	0.99	0.99	1.39	1.39	4.75	9.50 (3.00-11.00)	2.51 (0.30-3.46)	3.78	9.5	6.5	A++	
5		5	7	9	9	1.36	1.36	1.90	2.44	2.44	9.50 (3.00-11.00)	2.51 (0.30-3.46)	3.78	9.5	6.5	A++	
5		5	7	9	12	1.25	1.25	1.75	2.25	3.00	9.50 (3.00-11.00)	2.51 (0.30-3.46)	3.78	9.5	6.5	A++	
5		5	7	9	14	1.19	1.19	1.66	2.14	3.33	9.50 (3.00-11.00)	2.51 (0.30-3.46)	3.78	9.5	6.5	A++	
5		5	7	9	18	1.08	1.08	1.44	1.94	3.89	9.50 (3.00-11.00)	2.51 (0.30-3.46)	3.78	9.5	6.5	A++	
5		5	7	9	22	0.99	0.99	1.39	1.78	4.35	9.50 (3.00-11.00)	2.51 (0.30-3.46)	3.78	9.5	6.5	A++	
5		5	7	9	24	0.95	0.95	1.33	1.71	4.56	9.50 (3.00-11.00)	2.51 (0.30-3.46)	3.78	9.5	6.5	A++	
5		5	7	12	12	1.16	1.16	1.62	2.78	2.78	9.50 (3.00-11.00)	2.51 (0.30-3.46)	3.78	9.5	6.5	A++	
5		5	7	12	14	1.10	1.10	1.55	2.65	3.09	9.50 (3.00-11.00)	2.51 (0.30-3.46)	3.78	9.5	6.5	A++	
5		5	7	12	18	1.01	1.01	1.41	2.43	3.64	9.50 (3.00-11.00)	2.51 (0.30-3.46)	3.78	9.5	6.5	A++	
5		5	7	12	22	0.93	0.93	1.30	2.24	4.10	9.50 (3.00-11.00)	2.51 (0.30-3.46)	3.78	9.5	6.5	A++	
5		5	7	12	24	0.90	0.90	1.25	2.15	4.30	9.50 (3.00-11.00)	2.51 (0.30-3.46)	3.78	9.5	6.5	A++	
5		5	7	14	14	1.06	1.06	1.48	2.96	2.96	9.50 (3.00-11.00)	2.51 (0.30-3.46)	3.78	9.5	6.5	A++	
5		5	7	14	18	0.97	0.97	1.36	2.71	3.49	9.50 (3.00-11.00)	2.51 (0.30-3.46)	3.78	9.5	6.5	A++	
5		5	7	14	22	0.90	0.90	1.25	2.51	3.94	9.50 (3.00-11.00)	2.51 (0.30-3.46)	3.78	9.5	6.5	A++	
5		5	7	18	18	0.90	0.90	1.25	2.23	3.23	9.50 (3.00-11.00)	2.51 (0.30-3.46)	3.78	9.5	6.5	A++	
5		5	9	9	9	1.28	1.28	2.31	2.31	2.31	9.50 (3.00-11.00)	2.51 (0.30-3.46)	3.78	9.5	6.5	A++	
5		5	9	9	12	1.19	1.19	2.14	2.14	2.85	9.50 (3.00-11.00)	2.51 (0.30-3.46)	3.78	9.5	6.5	A++	
5		5	9	9	14	1.13	1.13	2.04	2.04	3.17	9.50 (3.00-11.00)	2.51 (0.30-3.46)	3.78	9.5	6.5	A++	
5		5	9	9	18	1.03	1.03	1.86	1.86	3.72	9.50 (3.						



5-unit Multi-Split Combination Table-Heating



The data in the table below shows the performance of various combinations of indoor and outdoor units of different capacities, using the most efficient type of indoor unit. These values should not be interpreted as official declarations for tax incentives or other certifications. For more information on specific types of indoor and outdoor unit combinations, please refer to the Design & Technical Manual.

5-unit Multi-split heating

AOHG36KBTAS	Combination of Indoor Units					Heating Operation					Seasonal Data							
						Heating Capacity					Input Power (Min. - Max.)	COP	Pdesign	SCOP	Energy efficiency			
						Unit 1	Unit 2	Unit 3	Unit 4	Unit 5						Total Capacity (Min. - Max.)		
4-unit connection	9	9	12	14	-	2.17	2.17	2.89	3.37	-	10.60 (3.50-12.00)	2.44 (0.25-3.25)	4.34	7.0	4.5	A+		
	9	9	12	18	-	1.99	1.99	2.64	3.98	-	10.60 (3.50-12.00)	2.44 (0.25-3.25)	4.34	7.0	4.5	A+		
	9	9	12	22	-	1.83	1.83	2.45	4.49	-	10.60 (3.50-12.00)	2.44 (0.25-3.25)	4.34	7.0	4.5	A+		
	9	9	12	24	-	1.77	1.77	2.35	4.71	-	10.60 (3.50-12.00)	2.44 (0.25-3.25)	4.34	7.0	4.5	A+		
	9	9	14	14	-	2.07	2.07	3.23	3.23	-	10.60 (3.50-12.00)	2.44 (0.25-3.25)	4.34	7.0	4.5	A+		
	9	9	14	18	-	1.91	1.91	2.94	3.82	-	10.60 (3.50-12.00)	2.44 (0.25-3.25)	4.34	7.0	4.5	A+		
	9	9	18	18	-	1.77	1.77	3.53	3.53	-	10.60 (3.50-12.00)	2.44 (0.25-3.25)	4.34	7.0	4.5	A+		
	9	12	12	12	-	2.11	2.83	2.83	2.83	-	10.60 (3.50-12.00)	2.44 (0.25-3.25)	4.34	7.0	4.5	A+		
	9	12	12	14	-	2.02	2.71	2.71	3.16	-	10.60 (3.50-12.00)	2.44 (0.25-3.25)	4.34	7.0	4.5	A+		
	9	12	12	18	-	1.87	2.49	2.49	3.75	-	10.60 (3.50-12.00)	2.44 (0.25-3.25)	4.34	7.0	4.5	A+		
	9	12	14	14	-	1.94	2.60	3.03	3.03	-	10.60 (3.50-12.00)	2.44 (0.25-3.25)	4.34	7.0	4.5	A+		
	9	12	14	18	-	1.80	2.40	2.80	3.60	-	10.60 (3.50-12.00)	2.44 (0.25-3.25)	4.34	7.0	4.5	A+		
	9	14	14	14	-	1.87	2.91	2.91	2.91	-	10.60 (3.50-12.00)	2.44 (0.25-3.25)	4.34	7.0	4.5	A+		
	12	12	12	12	-	2.65	2.65	2.65	2.65	-	10.60 (3.50-12.00)	2.44 (0.25-3.25)	4.34	7.0	4.5	A+		
	12	12	14	14	-	2.54	2.54	2.54	2.98	-	10.60 (3.50-12.00)	2.44 (0.25-3.25)	4.34	7.0	4.5	A+		
	12	12	12	18	-	2.36	2.36	2.36	3.52	-	10.60 (3.50-12.00)	2.44 (0.25-3.25)	4.34	7.0	4.5	A+		
	12	12	14	14	-	2.45	2.45	2.85	2.85	-	10.60 (3.50-12.00)	2.44 (0.25-3.25)	4.34	7.0	4.5	A+		
	12	14	14	14	-	2.35	2.75	2.75	2.75	-	10.60 (3.50-12.00)	2.44 (0.25-3.25)	4.34	7.0	4.5	A+		
	5-unit connection	5	5	5	5	7	1.39	1.39	1.39	1.94	1.94	7.50 (3.50-10.80)	1.98 (0.25-2.84)	3.78	6.8	4.3	A+	
		5	5	5	5	9	1.38	1.38	1.38	2.48	2.48	8.00 (3.50-11.60)	2.08 (0.25-3.12)	3.85	7.0	4.3	A+	
5		5	5	5	12	1.41	1.41	1.41	3.38	3.38	9.00 (3.50-12.00)	2.37 (0.25-3.26)	3.80	7.0	4.3	A+		
5		5	5	5	14	1.40	1.40	1.40	3.91	3.91	9.50 (3.50-12.00)	2.37 (0.25-3.26)	4.01	7.0	4.3	A+		
5		5	5	5	18	1.25	1.25	1.25	4.50	4.50	9.50 (3.50-12.00)	2.37 (0.25-3.26)	4.01	7.0	4.3	A+		
5		5	5	5	22	1.13	1.13	1.13	4.98	4.98	9.50 (3.50-12.00)	2.37 (0.25-3.26)	4.01	7.0	4.3	A+		
5		5	5	5	24	1.08	1.08	1.08	5.18	5.18	9.50 (3.50-12.00)	2.37 (0.25-3.26)	4.01	7.0	4.3	A+		
5		5	5	5	7	1.38	1.38	1.38	1.93	1.93	8.00 (3.50-11.60)	2.08 (0.25-3.12)	3.85	7.0	4.3	A+		
5		5	5	5	9	1.45	1.45	1.45	2.03	2.61	9.00 (3.50-12.00)	2.18 (0.25-3.26)	4.14	7.0	4.3	A+		
5		5	5	5	12	1.40	1.40	1.40	1.96	3.35	9.50 (3.50-12.00)	2.37 (0.25-3.26)	4.01	7.0	4.3	A+		
5		5	5	5	14	1.32	1.32	1.32	1.85	3.69	9.50 (3.50-12.00)	2.37 (0.25-3.26)	4.01	7.0	4.3	A+		
5		5	5	5	18	1.19	1.19	1.19	1.66	4.28	9.50 (3.50-12.00)	2.37 (0.25-3.26)	4.01	7.0	4.3	A+		
5		5	5	5	7	22	1.08	1.08	1.01	4.75	9.50 (3.50-12.00)	2.37 (0.25-3.26)	4.01	7.0	4.3	A+		
5		5	5	5	7	24	1.03	1.03	1.03	4.96	9.50 (3.50-12.00)	2.37 (0.25-3.26)	4.01	7.0	4.3	A+		
5		5	5	5	9	1.44	1.44	1.44	1.59	2.43	9.50 (3.50-12.00)	2.37 (0.25-3.26)	4.01	7.0	4.3	A+		
5		5	5	5	9	12	1.32	1.32	1.32	3.17	9.50 (3.50-12.00)	2.37 (0.25-3.26)	4.01	7.0	4.3	A+		
5		5	5	5	9	14	1.25	1.25	1.25	3.50	9.50 (3.50-12.00)	2.37 (0.25-3.26)	4.01	7.0	4.3	A+		
5		5	5	5	9	18	1.13	1.13	1.13	2.04	4.07	9.50 (3.50-12.00)	2.37 (0.25-3.26)	4.01	7.0	4.3	A+	
5		5	5	5	9	22	1.03	1.03	1.03	1.86	4.54	9.50 (3.50-12.00)	2.37 (0.25-3.26)	4.01	7.0	4.3	A+	
5		5	5	5	9	24	0.99	0.99	0.99	1.78	4.75	9.50 (3.50-12.00)	2.37 (0.25-3.26)	4.01	7.0	4.3	A+	
5		5	5	5	12	1.22	1.22	1.22	2.92	2.92	9.50 (3.50-12.00)	2.37 (0.25-3.26)	4.01	7.0	4.3	A+		
5		5	5	5	12	14	1.16	1.16	1.16	2.78	3.24	9.50 (3.50-12.00)	2.37 (0.25-3.26)	4.01	7.0	4.3	A+	
5		5	5	5	12	18	1.06	1.06	1.06	2.53	3.80	9.50 (3.50-12.00)	2.37 (0.25-3.26)	4.01	7.0	4.3	A+	
5		5	5	5	12	24	0.97	0.97	0.97	2.33	4.27	9.50 (3.50-12.00)	2.37 (0.25-3.26)	4.01	7.0	4.3	A+	
5		5	5	5	12	24	0.93	0.93	0.93	2.24	4.47	9.50 (3.50-12.00)	2.37 (0.25-3.26)	4.01	7.0	4.3	A+	
5		5	5	5	14	1.10	1.10	1.10	3.09	3.09	9.50 (3.50-12.00)	2.37 (0.25-3.26)	4.01	7.0	4.3	A+		
5		5	5	5	14	18	1.01	1.01	1.01	2.83	3.64	9.50 (3.50-12.00)	2.37 (0.25-3.26)	4.01	7.0	4.3	A+	
5		5	5	5	14	22	0.93	0.93	0.93	2.61	4.10	9.50 (3.50-12.00)	2.37 (0.25-3.26)	4.01	7.0	4.3	A+	
5		5	5	5	14	24	0.90	0.90	0.90	2.51	4.30	9.50 (3.50-12.00)	2.37 (0.25-3.26)	4.01	7.0	4.3	A+	
5		5	5	5	18	1.03	1.03	1.03	3.35	3.35	9.50 (3.50-12.00)	2.37 (0.25-3.26)	4.01	7.0	4.2	A+		
5		5	5	5	7	7	1.45	1.45	2.03	2.03	2.03	9.00 (3.50-12.00)	2.18 (0.25-3.26)	4.14	7.0	4.3	A+	
5		5	5	5	7	7	1.44	1.44	2.02	2.02	2.02	9.50 (3.50-12.00)	2.37 (0.25-3.26)	4.01	7.0	4.3	A+	
5		5	5	5	7	12	1.32	1.32	1.85	1.85	3.17	9.50 (3.50-12.00)	2.37 (0.25-3.26)	4.01	7.0	4.3	A+	
5		5	5	5	7	14	1.25	1.25	1.75	1.75	3.50	9.50 (3.50-12.00)	2.37 (0.25-3.26)	4.01	7.0	4.3	A+	
5		5	5	5	7	18	1.13	1.13	1.58	1.58	4.07	9.50 (3.50-12.00)	2.37 (0.25-3.26)	4.01	7.0	4.3	A+	
5		5	5	5	7	22	1.03	1.03	1.45	1.45	4.54	9.50 (3.50-12.00)	2.37 (0.25-3.26)	4.01	7.0	4.3	A+	
5		5	5	5	7	24	0.99	0.99	1.39	1.39	4.75	9.50 (3.50-12.00)	2.37 (0.25-3.26)	4.01	7.0	4.3	A+	
5		5	5	5	7	9	1.36	1.36	1.90	2.44	2.44	9.50 (3.50-12.00)	2.37 (0.25-3.26)	4.01	7.0	4.3	A+	
5		5	5	5	7	12	1.25	1.25	1.75	2.25	3.00	9.50 (3.50-12.00)	2.37 (0.25-3.26)	4.01	7.0	4.3	A+	
5		5	5	5	7	9	14	1.19	1.19	1.66	2.14	3.33	9.50 (3.50-12.00)	2.37 (0.25-3.26)	4.01	7.0	4.3	A+
5		5	5	5	7	18	1.08	1.08	1.44	1.99	3.99	9.50 (3.50-12.00)	2.37 (0.25-3.26)	4.01	7.0	4.3	A+	
5		5	5	5	7	9	22	0.99	0.99	1.39	1.78	4.36	9.50 (3.50-12.00)	2.37 (0.25-3.26)	4.01	7.0	4.3	A+
5		5	5	5	7	9	24	0.95	0.95	1.33	1.71	4.56	9.50 (3.50-12.00)	2.37 (0.25-3.26)	4.01	7.0	4.3	A+
5		5	5	5	7	12	1.16	1.16	1.62	2.78	2.78	9.50 (3.50-12.00)	2.37 (0.25-3.26)	4.01	7.0	4.3	A+	
5		5	5	5	7	12	14	1.10	1.10	1.55	2.65	3.09	9.50 (3.50-12.00)	2.37 (0.25-3.26)	4.01	7.0	4.3	A+
5		5	5	5	7	12	18	1.01	1.01	1.41	2.43	3.64	9.50 (3.50-12.00)	2.37 (0.25-3.26)	4.01	7.0	4.3	A+
5		5	5	5	7	12	22	0.93	0.93	1.30	2.24	4.10	9.50 (3.50-12.00)	2.37 (0.25-3.26)	4.01	7.0	4.3	A+
5		5	5	5	7	12	24	0.90	0.90	1.25	2.15	4.30	9.50 (3.50-12.00)	2.37 (0.25-3.26)	4.01	7.0	4.3	A+
5		5	5	5	7	14	1.06	1.06	1.48	2.96	2.96	9.50 (3.50-12.00)	2.37 (0.25-3.26)	4.01	7.0	4.3	A+	
5		5	5	5	7	14	18	0.97	0.97	1.36	2.71	3.49	9.50 (3.50-12.00)	2.37 (0.25-3.26)	4.01	7.0	4.3	A+
5		5	5	5	7	18	0.90	0.90	1.25	2.51	3.94	9.50 (3.50-12.00)	2.37 (0.25-3.26)	4.01	7.0	4.3	A+	
5		5	5	5	7	18	0.90	0.90	1.25	3.23	3.23	9.50 (3.50-12.00)	2.37 (0.25-3.26)	4.01	7.0	4.3	A+	
5		5	5	5	9	9	1.28	1.28	2.31	2.31	2.31	9.50 (3.50-12.00)	2.37 (0.25-3.26)	4.01	7.0	4.3	A+	
5		5	5	5	9	12	1.19	1.19	2.14	2.14	2.85	9.50 (3.50-12.00)	2.37 (0.25-3.26)	4.01	7.0	4.3	A+	
5		5																



6-unit Multi-Split Combination Table-Cooling

6-unit Multi-split cooling

AOHG45L6A6	Combination of Indoor Units						Cooling Operation					Input Power (Min. - Max.) kW	EER	
							Cooling Capacity							
							Unit 1 kW	Unit 2 kW	Unit 3 kW	Unit 4 kW	Unit 5 kW			Unit 6 kW
2-unit connection	12	24	-	-	-	-	3.50	7.00	-	-	-	10.5 (3.5-11.5)	3.06 (0.8-3.32)	3.43
	14	24	-	-	-	-	4.00	7.00	-	-	-	11.0 (3.5-12.1)	3.28 (0.8-3.70)	3.35
	18	18	-	-	-	-	5.00	5.00	-	-	-	10.0 (3.5-11.5)	2.92 (0.8-3.32)	3.42
	18	24	-	-	-	-	5.00	7.00	-	-	-	12.0 (3.5-13.4)	3.75 (0.8-4.46)	3.20
	24	24	-	-	-	-	6.25	6.25	-	-	-	12.5 (3.5-14.0)	4.01 (0.8-4.84)	3.12
	7	7	24	-	-	-	2.00	2.00	7.00	-	-	11.0 (3.5-12.1)	3.19 (0.8-3.70)	3.45
	7	9	18	-	-	-	2.00	2.50	5.00	-	-	9.5 (3.5-10.8)	2.55 (0.8-2.93)	3.73
	7	9	24	-	-	-	2.00	2.50	7.00	-	-	11.5 (3.5-12.7)	3.41 (0.8-4.08)	3.37
	7	12	18	-	-	-	2.00	3.50	5.00	-	-	10.5 (3.5-11.8)	3.02 (0.8-3.51)	3.48
	7	12	24	-	-	-	2.00	3.50	6.90	-	-	12.4 (3.5-13.7)	3.82 (0.8-4.65)	3.25
	7	14	14	-	-	-	2.00	4.00	4.00	-	-	10.0 (3.5-11.1)	2.81 (0.8-3.13)	3.56
	7	14	18	-	-	-	2.00	4.00	5.00	-	-	11.0 (3.5-12.4)	3.23 (0.8-3.89)	3.41
7	14	24	-	-	-	1.94	3.89	6.67	-	-	12.5 (3.5-14.0)	3.89 (0.8-4.84)	3.21	
7	18	18	-	-	-	2.00	5.00	5.00	-	-	12.0 (3.5-13.7)	3.69 (0.8-4.65)	3.25	
7	18	24	-	-	-	1.79	4.59	6.12	-	-	12.5 (3.5-14.0)	3.87 (0.8-4.84)	3.23	
7	24	24	-	-	-	1.60	5.45	5.45	-	-	12.5 (3.5-14.0)	3.83 (0.8-4.84)	3.26	
9	9	18	-	-	-	2.50	2.50	5.00	-	-	10.0 (3.5-11.5)	2.84 (0.8-3.32)	3.52	
9	9	24	-	-	-	2.50	2.50	7.00	-	-	12.0 (3.5-13.4)	3.65 (0.8-4.46)	3.29	
9	12	14	-	-	-	2.50	3.50	4.00	-	-	10.0 (3.5-11.1)	2.81 (0.8-3.13)	3.56	
9	12	18	-	-	-	2.50	3.50	5.00	-	-	11.0 (3.5-12.4)	3.23 (0.8-3.89)	3.41	
9	12	24	-	-	-	2.50	3.33	6.67	-	-	12.5 (3.5-14.0)	3.89 (0.8-4.84)	3.21	
9	14	14	-	-	-	2.50	4.00	4.00	-	-	10.5 (3.5-11.8)	3.02 (0.8-3.51)	3.48	
9	14	18	-	-	-	2.50	4.00	5.00	-	-	11.5 (3.5-13.0)	3.45 (0.8-4.27)	3.33	
9	14	24	-	-	-	2.40	3.72	6.38	-	-	12.5 (3.5-14.0)	3.88 (0.8-4.84)	3.22	
9	18	18	-	-	-	2.50	5.00	5.00	-	-	12.5 (3.5-14.0)	3.89 (0.8-4.84)	3.21	
9	18	24	-	-	-	2.21	4.41	5.88	-	-	12.5 (3.5-14.0)	3.86 (0.8-4.84)	3.24	
9	24	24	-	-	-	1.98	5.26	5.26	-	-	12.5 (3.5-14.0)	3.82 (0.8-4.84)	3.27	
12	12	12	-	-	-	3.50	3.50	3.50	-	-	10.5 (3.5-11.5)	2.98 (0.8-3.32)	3.52	
12	12	14	-	-	-	3.50	3.50	4.00	-	-	11.0 (3.5-12.1)	3.19 (0.8-3.70)	3.45	
12	12	18	-	-	-	3.50	3.50	5.00	-	-	12.0 (3.5-13.4)	3.65 (0.8-4.46)	3.29	
12	12	24	-	-	-	3.13	3.13	6.24	-	-	12.5 (3.5-14.0)	3.87 (0.8-4.84)	3.23	
12	14	14	-	-	-	3.50	4.00	4.00	-	-	11.5 (3.5-12.7)	3.41 (0.8-4.08)	3.37	
12	14	18	-	-	-	3.50	4.00	5.00	-	-	12.5 (3.5-14.0)	3.89 (0.8-4.84)	3.21	
12	14	24	-	-	-	3.00	3.50	6.00	-	-	12.5 (3.5-14.0)	3.86 (0.8-4.84)	3.24	
12	18	18	-	-	-	3.12	4.69	4.69	-	-	12.5 (3.5-14.0)	3.87 (0.8-4.84)	3.23	
12	18	24	-	-	-	2.78	4.17	5.55	-	-	12.5 (3.5-14.0)	3.85 (0.8-4.84)	3.25	
12	24	24	-	-	-	2.50	5.00	5.00	-	-	12.5 (3.5-14.0)	3.81 (0.8-4.84)	3.28	
14	14	14	-	-	-	4.00	4.00	4.00	-	-	12.0 (3.5-13.4)	3.65 (0.8-4.46)	3.29	
14	14	18	-	-	-	3.80	3.80	4.90	-	-	12.5 (3.5-14.0)	3.88 (0.8-4.84)	3.22	
14	14	24	-	-	-	3.37	3.37	5.76	-	-	12.5 (3.5-14.0)	3.85 (0.8-4.84)	3.25	
14	18	18	-	-	-	3.50	4.50	4.50	-	-	12.5 (3.5-14.0)	3.86 (0.8-4.84)	3.24	
14	18	24	-	-	-	3.13	4.02	5.35	-	-	12.5 (3.5-14.0)	3.83 (0.8-4.84)	3.26	
14	24	24	-	-	-	2.82	4.84	4.84	-	-	12.5 (3.5-14.0)	3.80 (0.8-4.84)	3.29	
18	18	18	-	-	-	4.17	4.17	4.17	-	-	12.5 (3.5-14.0)	3.85 (0.8-4.84)	3.25	
18	18	24	-	-	-	3.75	3.75	5.00	-	-	12.5 (3.5-14.0)	3.81 (0.8-4.84)	3.28	
7	7	7	14	-	-	2.00	2.00	2.00	4.00	-	10.0 (3.5-11.1)	2.50 (0.8-3.13)	4.00	
7	7	7	18	-	-	2.00	2.00	2.00	5.00	-	11.0 (3.5-12.4)	3.06 (0.8-3.89)	3.59	
7	7	7	24	-	-	1.94	1.94	1.94	6.68	-	12.5 (3.5-14.0)	3.77 (0.8-4.84)	3.32	
7	7	9	12	-	-	2.00	2.00	2.50	3.50	-	10.0 (3.5-11.1)	2.50 (0.8-3.13)	4.00	
7	7	9	14	-	-	2.00	2.00	2.50	4.00	-	10.5 (3.5-11.8)	2.79 (0.8-3.51)	3.76	
7	7	9	18	-	-	2.00	2.00	2.50	5.00	-	11.5 (3.5-13.0)	3.33 (0.8-4.27)	3.45	
7	7	9	24	-	-	1.86	1.86	2.39	6.39	-	12.5 (3.5-14.0)	3.75 (0.8-4.84)	3.33	
7	7	12	12	-	-	2.00	2.00	3.50	3.50	-	11.0 (3.5-12.1)	3.00 (0.8-3.70)	3.67	
7	7	12	14	-	-	2.00	2.00	3.50	4.00	-	11.5 (3.5-12.7)	3.27 (0.8-4.08)	3.52	
7	7	12	18	-	-	2.00	2.00	3.50	5.00	-	12.5 (3.5-14.0)	3.78 (0.8-4.84)	3.31	
7	7	12	24	-	-	1.75	1.75	3.00	6.00	-	12.5 (3.5-14.0)	3.74 (0.8-4.84)	3.34	
7	7	14	14	-	-	2.00	2.00	4.00	4.00	-	12.0 (3.5-13.4)	3.51 (0.8-4.46)	3.42	
7	7	14	18	-	-	1.90	1.90	3.80	4.90	-	12.5 (3.5-14.0)	3.77 (0.8-4.84)	3.32	
7	7	14	24	-	-	1.68	1.68	3.37	5.77	-	12.5 (3.5-14.0)	3.73 (0.8-4.84)	3.35	
7	7	18	18	-	-	1.75	1.75	4.50	4.50	-	12.5 (3.5-14.0)	3.74 (0.8-4.84)	3.34	
7	7	18	24	-	-	1.56	1.56	4.02	5.36	-	12.5 (3.5-14.0)	3.70 (0.8-4.84)	3.38	
7	7	24	24	-	-	1.41	1.41	4.84	4.84	-	12.5 (3.5-14.0)	3.67 (0.8-4.84)	3.41	
7	9	9	9	-	-	2.00	2.50	2.50	2.50	-	9.5 (3.5-10.8)	2.31 (0.8-2.93)	4.11	
7	9	9	12	-	-	2.00	2.50	2.50	3.50	-	10.5 (3.5-11.8)	2.79 (0.8-3.51)	3.76	
7	9	9	14	-	-	2.00	2.50	2.50	4.00	-	11.0 (3.5-12.4)	3.06 (0.8-3.89)	3.59	
7	9	9	18	-	-	2.00	2.50	2.50	5.00	-	12.0 (3.5-13.7)	3.57 (0.8-4.65)	3.36	
7	9	9	24	-	-	1.79	2.30	2.30	6.11	-	12.5 (3.5-14.0)	3.74 (0.8-4.84)	3.34	
7	9	12	12	-	-	2.00	2.50	3.50	3.50	-	11.5 (3.5-12.7)	3.27 (0.8-4.08)	3.52	
7	9	12	14	-	-	2.00	2.50	3.50	4.00	-	12.0 (3.5-13.4)	3.51 (0.8-4.46)	3.42	
7	9	12	18	-	-	1.90	2.45	3.26	4.89	-	12.5 (3.5-14.0)	3.77 (0.8-4.84)	3.32	
7	9	12	24	-	-	1.68	2.16	2.88	5.78	-	12.5 (3.5-14.0)	3.73 (0.8-4.84)	3.35	
7	9	14	14	-	-	2.00	2.50	4.00	4.00	-	12.5 (3.5-14.0)	3.78 (0.8-4.84)	3.31	
7	9	14	18	-	-	1.82	2.34	3.65	4.69	-	12.5 (3.5-14.0)	3.75 (0.8-4.84)	3.33	
7	9	14	24	-	-	1.62	2.08	3.24	5.56	-	12.5 (3.5-14.0)	3.71 (0.8-4.84)	3.37	
7	9	18	18	-	-	1.68	2.16	4.33	4.33	-	12.5 (3.5-14.0)	3.73 (0.8-4.84)	3.35	
7	9	18	24	-	-	1.51	1.94	3.88	5.17	-	12.5 (3.5-14.0)	3.69 (0.8-4.84)	3.39	
7	12	12	12	-	-	1.90	3.50	3.50	3.50	-	12.4 (3.5-13.7)	3.69 (0.8-4.65)	3.36	
7	12	12	14	-	-	1.94	3.33	3.33	3.90	-	12.5 (3.5-14.0)	3.77 (0.8-4.84)	3.32	
7	12	12	18	-	-	1.79	3.06	3.06	4.59	-	12.5 (3.5-14.0)	3.74 (0.8-4.84)	3.34	
7	12	12	24	-	-	1.59	2.73	2.73	5.45	-	12.5 (3.5-14.0)	3.71 (0.8-4.84)	3.37	
7	12	14	14	-	-	1.87	3.19	3.72	3.72	-	12.5 (3.5-14.0)	3.75 (0.8-4.84)	3.33	
7	12	14	18	-	-	1.72	2.94	3.43	4.41	-	12.5 (3.5-14.0)	3.73 (0.8-4.84)	3.35	
7	12	14	24	-	-	1.54	2.63	3.07	5.26	-	12.5 (3.5-14.0)	3.70 (0.8-4.84)	3.38	
7	12	18	18	-	-	1.62	2.16	4.33	4.33	-	12.5 (3.5-14.0)	3.73 (0.8-4.84)	3.35	
7	12	18	24	-	-	1.43	2.46	3.69	4.92	-	12.5 (3.5-14.0)	3.68 (0.8-4.84)	3.40	
7	14	14	14	-	-	1.79	3.57	3.57	3.57	-	12.5 (3.5-14.0)	3.74 (0.8-4.84)	3.34	
7	14	14	18	-	-	1.65	3.30	3.30	4.25	-	12.5 (3.5-14.0)	3.72 (0.8-4.84)	3.36	
7	14	14	24	-	-	1.48	2.97	2.97	5.08	-	12.5 (3.5-14.0)	3.69 (0.8-4.84)	3.39	
7	14	18	18	-	-	1.53	3.07	3.95	3.95	-	12.5 (3.5-14.0)	3.70 (0.8-4.84)	3.38	
7	18	18	18	-	-	1.43	3.69	3.69	3.69	-	12.5 (3.5-14.0)	3.68 (0.8-4.84)	3.40	
9	9	9	9	-	-	2.50	2.50	2.50	2.50	-	10.0 (3.5-11.5)	2.59 (0.8-3.32)	3.86	
9	9	9	12	-	-	2.50	2.50	2.50	3.50	-	11.0 (3.5-12.4)	3.06 (0.8-3.89)	3.59	

6-unit Multi-split cooling

AOHG45L6A6	Combination of Indoor Units						Cooling Operation					Input Power (Min. - Max.) kW	EER	
							Cooling Capacity							
							Unit 1 kW	Unit 2 kW	Unit 3 kW	Unit 4 kW	Unit 5 kW			Unit 6 kW
2-unit connection	9	9	9	14	-	-	2.50	2.50	2.50	4.00	-	11.5 (3.5-13.0)	3.33 (0.8-4.27)	3.45
	9	9	9	18	-	-	2.50	2.50	2.50	5.00	-	12.5 (3.5-14.0)	3.77 (0.8-4.84)	



6-unit Multi-Split Combination Table-Cooling/Heating

6-unit Multi-split cooling

AOHG45L6LA6	Combination of Indoor Units						Cooling Operation							Input Power (Min. - Max.)	EER
							Cooling Capacity						Total Capacity (Min. - Max.)		
							Unit 1	Unit 2	Unit 3	Unit 4	Unit 5	Unit 6			
						kW	kW	kW	kW	kW	kW	kW	kW	kW	kW
5-unit connection	7	9	12	14	18	-	1.46	1.88	2.50	2.92	3.74	-	12.5 (3.5-14.0)	3.56 (0.8-4.84)	3.51
	7	9	14	14	14	-	1.50	1.94	3.02	3.02	3.02	-	12.5 (3.5-14.0)	3.57 (0.8-4.84)	3.50
	7	9	14	14	18	-	1.41	1.81	2.82	2.82	3.64	-	12.5 (3.5-14.0)	3.55 (0.8-4.84)	3.52
	7	12	12	12	12	-	1.58	2.73	2.73	2.73	2.73	-	12.5 (3.5-14.0)	3.59 (0.8-4.84)	3.48
	7	12	12	12	14	-	1.54	2.63	2.63	2.63	3.07	-	12.5 (3.5-14.0)	3.58 (0.8-4.84)	3.49
	7	12	12	12	18	-	1.43	2.46	2.46	2.46	3.69	-	12.5 (3.5-14.0)	3.56 (0.8-4.84)	3.51
	7	12	12	14	14	-	1.48	2.54	2.54	2.97	2.97	-	12.5 (3.5-14.0)	3.57 (0.8-4.84)	3.50
	7	12	14	14	14	-	1.43	2.46	2.87	2.87	2.87	-	12.5 (3.5-14.0)	3.56 (0.8-4.84)	3.51
	9	9	9	9	9	-	2.50	2.50	2.50	2.50	2.50	-	12.5 (3.5-14.0)	3.65 (0.8-4.84)	3.42
	9	9	9	9	12	-	2.34	2.34	2.34	2.34	3.14	-	12.5 (3.5-14.0)	3.64 (0.8-4.84)	3.43
	9	9	9	9	14	-	2.25	2.25	2.25	2.25	3.50	-	12.5 (3.5-14.0)	3.62 (0.8-4.84)	3.45
	9	9	9	9	18	-	2.08	2.08	2.08	2.08	4.18	-	12.5 (3.5-14.0)	3.60 (0.8-4.84)	3.47
	9	9	9	9	24	-	1.88	1.88	1.88	1.88	4.98	-	12.5 (3.5-14.0)	3.56 (0.8-4.84)	3.51
	9	9	9	12	12	-	2.21	2.21	2.21	2.94	2.94	-	12.5 (3.5-14.0)	3.62 (0.8-4.84)	3.45
	9	9	9	12	14	-	2.12	2.12	2.12	2.83	3.31	-	12.5 (3.5-14.0)	3.60 (0.8-4.84)	3.47
	9	9	9	12	18	-	1.97	1.97	1.97	2.63	3.96	-	12.5 (3.5-14.0)	3.58 (0.8-4.84)	3.49
	9	9	9	14	14	-	2.05	2.05	2.05	3.18	3.18	-	12.5 (3.5-14.0)	3.59 (0.8-4.84)	3.48
	9	9	9	14	18	-	1.91	1.91	1.91	2.97	3.80	-	12.5 (3.5-14.0)	3.57 (0.8-4.84)	3.50
	9	9	12	12	12	-	2.08	2.08	2.78	2.78	2.78	-	12.5 (3.5-14.0)	3.60 (0.8-4.84)	3.47
	9	9	12	12	14	-	2.01	2.01	2.68	2.68	3.12	-	12.5 (3.5-14.0)	3.59 (0.8-4.84)	3.48
9	9	12	12	18	-	1.88	1.88	2.50	2.50	3.74	-	12.5 (3.5-14.0)	3.56 (0.8-4.84)	3.51	
9	9	12	14	14	-	1.94	1.94	2.58	3.02	3.02	-	12.5 (3.5-14.0)	3.57 (0.8-4.84)	3.50	
9	9	12	14	18	-	1.81	1.81	2.42	2.82	3.64	-	12.5 (3.5-14.0)	3.55 (0.8-4.84)	3.52	
9	9	14	14	14	-	1.87	1.87	2.92	2.92	2.92	-	12.5 (3.5-14.0)	3.56 (0.8-4.84)	3.51	
9	12	12	12	12	-	1.98	2.63	2.63	2.63	2.63	-	12.5 (3.5-14.0)	3.58 (0.8-4.84)	3.49	
9	12	12	12	14	-	1.91	2.54	2.54	2.54	2.97	-	12.5 (3.5-14.0)	3.57 (0.8-4.84)	3.50	
9	12	12	14	14	-	1.84	2.46	2.46	2.87	2.87	-	12.5 (3.5-14.0)	3.56 (0.8-4.84)	3.51	
12	12	12	12	12	-	2.50	2.50	2.50	2.50	2.50	-	12.5 (3.5-14.0)	3.56 (0.8-4.84)	3.51	
12	12	12	12	14	-	2.42	2.42	2.42	2.42	2.82	-	12.5 (3.5-14.0)	3.55 (0.8-4.84)	3.52	
7	7	7	7	7	7	2.00	2.00	2.00	2.00	2.00	2.00	12.0 (3.5-13.4)	3.32 (0.8-4.46)	3.61	
7	7	7	7	7	9	2.00	2.00	2.00	2.00	2.50	2.50	12.5 (3.5-14.0)	3.57 (0.8-4.84)	3.50	
7	7	7	7	7	12	1.86	1.86	1.86	1.86	3.20	3.20	12.5 (3.5-14.0)	3.55 (0.8-4.84)	3.52	
7	7	7	7	7	14	1.79	1.79	1.79	1.79	3.55	3.55	12.5 (3.5-14.0)	3.54 (0.8-4.84)	3.53	
7	7	7	7	7	18	1.65	1.65	1.65	1.65	4.25	4.25	12.5 (3.5-14.0)	3.51 (0.8-4.84)	3.56	
7	7	7	7	7	24	1.48	1.48	1.48	1.48	5.10	5.10	12.5 (3.5-14.0)	3.48 (0.8-4.84)	3.59	
7	7	7	7	9	9	1.90	1.90	1.90	1.90	2.45	2.45	12.5 (3.5-14.0)	3.56 (0.8-4.84)	3.51	
7	7	7	7	9	12	1.79	1.79	1.79	1.79	2.29	3.05	12.5 (3.5-14.0)	3.54 (0.8-4.84)	3.53	
7	7	7	7	9	14	1.72	1.72	1.72	1.72	2.20	3.42	12.5 (3.5-14.0)	3.53 (0.8-4.84)	3.54	
7	7	7	7	9	18	1.59	1.59	1.59	1.59	2.05	4.09	12.5 (3.5-14.0)	3.50 (0.8-4.84)	3.57	
7	7	7	7	9	24	1.43	1.43	1.43	1.43	1.85	4.93	12.5 (3.5-14.0)	3.47 (0.8-4.84)	3.60	
7	7	7	7	12	12	1.68	1.68	1.68	1.68	2.89	2.89	12.5 (3.5-14.0)	3.52 (0.8-4.84)	3.55	
7	7	7	7	12	14	1.62	1.62	1.62	1.62	2.78	3.24	12.5 (3.5-14.0)	3.51 (0.8-4.84)	3.56	
7	7	7	7	12	18	1.51	1.51	1.51	1.51	2.59	3.87	12.5 (3.5-14.0)	3.48 (0.8-4.84)	3.59	
7	7	7	7	14	14	1.56	1.56	1.56	1.56	3.13	3.13	12.5 (3.5-14.0)	3.50 (0.8-4.84)	3.57	
7	7	7	7	14	18	1.46	1.46	1.46	1.46	2.92	3.74	12.5 (3.5-14.0)	3.47 (0.8-4.84)	3.60	
7	7	7	9	9	9	1.82	1.82	1.82	2.34	2.34	2.34	12.5 (3.5-14.0)	3.55 (0.8-4.84)	3.52	
7	7	7	9	9	12	1.72	1.72	1.72	2.21	2.21	2.92	12.5 (3.5-14.0)	3.53 (0.8-4.84)	3.54	
7	7	7	9	9	14	1.65	1.65	1.65	2.12	2.12	3.31	12.5 (3.5-14.0)	3.51 (0.8-4.84)	3.56	
7	7	7	9	9	18	1.54	1.54	1.54	1.97	1.97	3.94	12.5 (3.5-14.0)	3.49 (0.8-4.84)	3.58	
7	7	7	9	12	12	1.62	1.62	1.62	2.08	2.78	2.78	12.5 (3.5-14.0)	3.51 (0.8-4.84)	3.56	
7	7	7	9	12	14	1.56	1.56	1.56	2.01	2.68	3.13	12.5 (3.5-14.0)	3.50 (0.8-4.84)	3.57	
7	7	7	9	12	18	1.46	1.46	1.46	1.88	2.50	3.74	12.5 (3.5-14.0)	3.47 (0.8-4.84)	3.60	
7	7	7	9	14	14	1.51	1.51	1.51	1.93	3.02	3.02	12.5 (3.5-14.0)	3.48 (0.8-4.84)	3.59	
7	7	7	12	12	12	1.54	1.54	1.54	2.63	2.63	2.63	12.5 (3.5-14.0)	3.49 (0.8-4.84)	3.58	
7	7	7	12	12	14	1.48	1.48	1.48	2.54	2.98	2.98	12.5 (3.5-14.0)	3.48 (0.8-4.84)	3.59	
7	7	7	12	14	14	1.43	1.43	1.43	2.47	2.87	2.87	12.5 (3.5-14.0)	3.47 (0.8-4.84)	3.60	
7	7	9	9	9	9	1.75	1.75	2.25	2.25	2.25	2.25	12.5 (3.5-14.0)	3.53 (0.8-4.84)	3.54	
7	7	9	9	9	12	1.65	1.65	2.12	2.12	2.12	2.84	12.5 (3.5-14.0)	3.51 (0.8-4.84)	3.56	
7	7	9	9	9	14	1.59	1.59	2.05	2.05	2.05	3.17	12.5 (3.5-14.0)	3.50 (0.8-4.84)	3.57	
7	7	9	9	9	18	1.48	1.48	1.91	1.91	1.91	3.81	12.5 (3.5-14.0)	3.48 (0.8-4.84)	3.59	
7	7	9	9	12	12	1.56	1.56	2.01	2.01	2.68	2.68	12.5 (3.5-14.0)	3.50 (0.8-4.84)	3.57	
7	7	9	9	12	14	1.51	1.51	1.94	1.94	2.59	3.01	12.5 (3.5-14.0)	3.48 (0.8-4.84)	3.59	
7	7	9	9	12	18	1.41	1.41	1.81	1.81	2.42	3.64	12.5 (3.5-14.0)	3.46 (0.8-4.84)	3.61	
7	7	9	9	14	14	1.46	1.46	1.88	1.88	2.91	2.91	12.5 (3.5-14.0)	3.47 (0.8-4.84)	3.60	
7	7	9	12	12	14	1.48	1.48	1.92	2.54	2.54	2.54	12.5 (3.5-14.0)	3.48 (0.8-4.84)	3.59	
7	7	9	12	12	18	1.43	1.43	1.85	2.46	2.46	2.87	12.5 (3.5-14.0)	3.47 (0.8-4.84)	3.60	
7	7	12	12	12	12	1.41	1.41	2.42	2.42	2.42	2.42	12.5 (3.5-14.0)	3.46 (0.8-4.84)	3.61	
7	9	9	9	9	9	1.70	2.16	2.16	2.16	2.16	2.16	12.5 (3.5-14.0)	3.52 (0.8-4.84)	3.55	
7	9	9	9	9	12	1.59	2.05	2.05	2.05	2.05	2.71	12.5 (3.5-14.0)	3.50 (0.8-4.84)	3.57	
7	9	9	9	9	14	1.54	1.97	1.97	1.97	3.08	3.08	12.5 (3.5-14.0)	3.49 (0.8-4.84)	3.58	
7	9	9	9	12	12	1.50	1.94	1.94	1.94	2.59	2.59	12.5 (3.5-14.0)	3.48 (0.8-4.84)	3.59	
7	9	9	9	12	14	1.46	1.88	1.88	1.88	2.50	2.90	12.5 (3.5-14.0)	3.47 (0.8-4.84)	3.60	
7	9	9	12	12	14	1.44	1.84	1.84	2.46	2.46	2.46	12.5 (3.5-14.0)	3.47 (0.8-4.84)	3.60	
9	9	9	9	9	9	2.08	2.08	2.08	2.08	2.08	2.08	12.5 (3.5-14.0)	3.51 (0.8-4.84)	3.56	
9	9	9	9	9	12	1.97	1.97	1.97	1.97	2.65	2.65	12.5 (3.5-14.0)	3.49 (0.8-4.84)	3.58	
9	9	9	9	12	12	1.88	1.88	1.88	1.88	2.49	2.49	12.5 (3.5-14.0)	3.47 (0.8-4.84)	3.60	

- Notes: • 7: 7000 Btu/h/9: 9000 Btu/h/12: 12000 Btu/h/14: 14000 Btu/h/18: 18000 Btu/h/24: 24000 Btu/h models
 • The above specifications apply when connected with a wall-mounted unit.
 • 2 or more indoor units should be connected.
 • Cooling capacity is determined based on 27°CDB/19°CWB (indoor temperature) and 35°CDB (outdoor temperature).
 • Pipe Length: 5 m, Height difference: 0 m (Outdoor unit to Indoor unit)
 • Total capacity of indoor units connected must be between 36000Btu/h and 60000Btu/h.

6-unit Multi-split heating

AOHG45L6LA6	Combination of Indoor Units						Heating Operation							Input Power (Min. - Max.)	COP
							Heating Capacity						Total Capacity (Min. - Max.)		
							Unit 1	Unit 2	Unit 3	Unit 4	Unit 5	Unit 6			
						kW	kW	kW	kW	kW	kW	kW	kW	kW	
2-unit connection	12	24	-	-	-	-	4.07	8.13	-	-	-	-	12.2 (3.		



6-unit Multi-Split Combination Table-Heating

6-unit Multi-split heating

AOHG45LBA6	Combination of Indoor Units		Heating Operation							Input Power (Min. - Max.)	COP					
			Heating Capacity													
			Unit 1	Unit 2	Unit 3	Unit 4	Unit 5	Unit 6	Total Capacity (Min. - Max.)							
			kW	kW	kW	kW	kW	kW	kW	kW						
4-unit connection	9	9	9	14	-	-	2.85	2.85	2.85	4.45	-	-	13.0 (3.5-14.9)	3.46 (0.7-4.09)	3.76	
	9	9	9	18	-	-	2.70	2.70	2.70	5.40	-	-	13.5 (3.5-16.0)	3.61 (0.7-4.41)	3.74	
	9	9	9	24	-	-	2.38	2.38	2.38	6.36	-	-	13.5 (3.5-16.0)	3.59 (0.7-4.41)	3.76	
	9	9	12	12	-	-	2.83	2.83	3.77	3.77	-	-	13.2 (3.5-15.3)	3.52 (0.7-4.20)	3.75	
	9	9	12	14	-	-	2.76	2.76	3.68	4.30	-	-	13.5 (3.5-16.0)	3.61 (0.7-4.41)	3.74	
	9	9	12	18	-	-	2.53	2.53	3.38	5.06	-	-	13.5 (3.5-16.0)	3.60 (0.7-4.41)	3.75	
	9	9	12	24	-	-	2.25	2.25	3.00	6.00	-	-	13.5 (3.5-16.0)	3.58 (0.7-4.41)	3.77	
	9	9	14	14	-	-	2.64	2.64	4.11	4.11	-	-	13.5 (3.5-16.0)	3.61 (0.7-4.41)	3.74	
	9	9	14	18	-	-	2.43	2.43	3.78	4.86	-	-	13.5 (3.5-16.0)	3.60 (0.7-4.41)	3.75	
	9	9	14	24	-	-	2.17	2.17	3.38	5.78	-	-	13.5 (3.5-16.0)	3.58 (0.7-4.41)	3.77	
	9	9	18	18	-	-	2.25	2.25	4.50	4.50	-	-	13.5 (3.5-16.0)	3.58 (0.7-4.41)	3.77	
	9	9	18	24	-	-	2.03	2.03	4.05	5.39	-	-	13.5 (3.5-16.0)	3.57 (0.7-4.41)	3.78	
	9	12	12	12	-	-	2.70	3.60	3.60	3.60	-	-	13.5 (3.5-16.0)	3.61 (0.7-4.41)	3.74	
	9	12	12	14	-	-	2.59	3.45	3.45	4.01	-	-	13.5 (3.5-16.0)	3.60 (0.7-4.41)	3.75	
	9	12	12	18	-	-	2.38	3.18	3.18	4.76	-	-	13.5 (3.5-16.0)	3.59 (0.7-4.41)	3.76	
	9	12	12	24	-	-	2.13	2.84	2.84	5.69	-	-	13.5 (3.5-16.0)	3.57 (0.7-4.41)	3.78	
	9	12	14	14	-	-	2.48	3.30	3.86	3.86	-	-	13.5 (3.5-16.0)	3.60 (0.7-4.41)	3.75	
	9	12	14	18	-	-	2.29	3.06	3.57	4.58	-	-	13.5 (3.5-16.0)	3.59 (0.7-4.41)	3.76	
	9	12	14	24	-	-	2.06	2.75	3.20	5.49	-	-	13.5 (3.5-16.0)	3.57 (0.7-4.41)	3.78	
	9	12	18	18	-	-	2.13	2.85	4.26	4.26	-	-	13.5 (3.5-16.0)	3.57 (0.7-4.41)	3.78	
	9	14	14	14	-	-	2.37	3.71	3.71	3.71	-	-	13.5 (3.5-16.0)	3.59 (0.7-4.41)	3.76	
	9	14	14	18	-	-	2.21	3.44	3.44	4.41	-	-	13.5 (3.5-16.0)	3.58 (0.7-4.41)	3.77	
	9	14	14	24	-	-	1.99	3.10	3.10	5.31	-	-	13.5 (3.5-16.0)	3.56 (0.7-4.41)	3.79	
	9	14	18	18	-	-	2.06	3.20	4.12	4.12	-	-	13.5 (3.5-16.0)	3.57 (0.7-4.41)	3.78	
	12	12	12	12	-	-	3.38	3.38	3.38	3.38	-	-	13.5 (3.5-16.0)	3.60 (0.7-4.41)	3.75	
	12	12	12	14	-	-	3.24	3.24	3.24	3.78	-	-	13.5 (3.5-16.0)	3.60 (0.7-4.41)	3.75	
	12	12	12	18	-	-	3.00	3.00	3.00	4.50	-	-	13.5 (3.5-16.0)	3.58 (0.7-4.41)	3.77	
	12	12	12	24	-	-	2.70	2.70	2.70	5.40	-	-	13.5 (3.5-16.0)	3.57 (0.7-4.41)	3.78	
	12	12	14	14	-	-	3.12	3.12	3.63	3.63	-	-	13.5 (3.5-16.0)	3.59 (0.7-4.41)	3.76	
	12	12	14	18	-	-	2.89	2.89	3.38	4.34	-	-	13.5 (3.5-16.0)	3.58 (0.7-4.41)	3.77	
	12	12	14	24	-	-	2.61	2.61	3.05	5.23	-	-	13.5 (3.5-16.0)	3.56 (0.7-4.41)	3.79	
	12	12	18	18	-	-	2.70	2.70	4.05	4.05	-	-	13.5 (3.5-16.0)	3.57 (0.7-4.41)	3.78	
	12	14	14	14	-	-	3.00	3.50	3.50	3.50	-	-	13.5 (3.5-16.0)	3.58 (0.7-4.41)	3.77	
	12	14	14	18	-	-	2.79	3.26	3.26	4.19	-	-	13.5 (3.5-16.0)	3.57 (0.7-4.41)	3.78	
	12	14	18	18	-	-	2.61	3.05	3.92	3.92	-	-	13.5 (3.5-16.0)	3.56 (0.7-4.41)	3.79	
	7	7	7	7	7	-	-	2.40	2.40	2.40	2.40	-	-	12.0 (3.5-12.7)	2.82 (0.7-3.44)	4.26
	7	7	7	7	9	-	-	2.33	2.33	2.33	2.98	-	-	12.3 (3.5-13.5)	3.03 (0.7-3.65)	4.06
	7	7	7	7	12	-	-	2.24	2.24	2.24	3.84	-	-	12.8 (3.5-14.5)	3.29 (0.7-3.98)	3.89
	7	7	7	7	14	-	-	2.20	2.20	2.20	4.40	-	-	13.2 (3.5-15.3)	3.40 (0.7-4.20)	3.88
	7	7	7	7	18	-	-	2.05	2.05	2.05	5.30	-	-	13.5 (3.5-16.0)	3.49 (0.7-4.41)	3.87
	7	7	7	7	24	-	-	1.82	1.82	1.82	6.22	-	-	13.5 (3.5-16.0)	3.47 (0.7-4.41)	3.89
	7	7	7	9	9	-	-	2.28	2.28	2.93	2.93	-	-	12.7 (3.5-14.2)	3.23 (0.7-3.87)	3.93
	7	7	7	9	12	-	-	2.20	2.20	2.83	3.77	-	-	13.2 (3.5-15.3)	3.40 (0.7-4.20)	3.88
	7	7	7	9	14	-	-	2.15	2.15	2.76	4.29	-	-	13.5 (3.5-16.0)	3.49 (0.7-4.41)	3.87
	7	7	7	9	18	-	-	1.97	1.97	2.53	5.06	-	-	13.5 (3.5-16.0)	3.48 (0.7-4.41)	3.88
	7	7	7	9	24	-	-	1.75	1.75	2.25	6.00	-	-	13.5 (3.5-16.0)	3.46 (0.7-4.41)	3.90
	7	7	7	12	12	-	-	2.10	2.10	3.60	3.60	-	-	13.5 (3.5-16.0)	3.49 (0.7-4.41)	3.87
	7	7	7	12	14	-	-	2.01	2.01	3.45	4.02	-	-	13.5 (3.5-16.0)	3.48 (0.7-4.41)	3.88
7	7	7	12	18	-	-	1.85	1.85	3.18	4.77	-	-	13.5 (3.5-16.0)	3.47 (0.7-4.41)	3.89	
7	7	7	12	24	-	-	1.66	1.66	2.84	5.68	-	-	13.5 (3.5-16.0)	3.45 (0.7-4.41)	3.91	
7	7	7	14	14	-	-	1.93	1.93	3.86	3.86	-	-	13.5 (3.5-16.0)	3.48 (0.7-4.41)	3.88	
7	7	7	14	18	-	-	1.78	1.78	3.57	4.59	-	-	13.5 (3.5-16.0)	3.47 (0.7-4.41)	3.89	
7	7	7	14	24	-	-	1.60	1.60	3.20	5.50	-	-	13.5 (3.5-16.0)	3.45 (0.7-4.41)	3.91	
7	7	7	18	18	-	-	1.66	1.66	4.26	4.26	-	-	13.5 (3.5-16.0)	3.45 (0.7-4.41)	3.91	
7	7	9	9	9	-	-	2.22	2.22	2.85	2.85	-	-	13.0 (3.5-14.9)	3.34 (0.7-4.09)	3.89	
7	7	9	9	12	-	-	2.15	2.15	2.76	3.68	-	-	13.5 (3.5-16.0)	3.49 (0.7-4.41)	3.87	
7	7	9	9	14	-	-	2.05	2.05	2.64	4.12	-	-	13.5 (3.5-16.0)	3.49 (0.7-4.41)	3.87	
7	7	9	9	18	-	-	1.89	1.89	2.43	4.86	-	-	13.5 (3.5-16.0)	3.48 (0.7-4.41)	3.88	
7	7	9	9	24	-	-	1.69	1.69	2.17	5.78	-	-	13.5 (3.5-16.0)	3.46 (0.7-4.41)	3.90	
7	7	9	12	12	-	-	2.01	2.01	2.58	3.45	-	-	13.5 (3.5-16.0)	3.48 (0.7-4.41)	3.88	
7	7	9	12	14	-	-	1.93	1.93	3.31	3.85	-	-	13.5 (3.5-16.0)	3.48 (0.7-4.41)	3.88	
7	7	9	12	18	-	-	1.78	1.78	2.29	3.06	-	-	13.5 (3.5-16.0)	3.47 (0.7-4.41)	3.89	
7	7	9	12	24	-	-	1.60	1.60	2.75	5.49	-	-	13.5 (3.5-16.0)	3.45 (0.7-4.41)	3.91	
7	7	9	14	14	-	-	1.85	1.85	3.71	3.71	-	-	13.5 (3.5-16.0)	3.47 (0.7-4.41)	3.89	
7	7	9	14	18	-	-	1.72	1.72	3.44	4.41	-	-	13.5 (3.5-16.0)	3.46 (0.7-4.41)	3.90	
7	7	9	14	24	-	-	1.55	1.55	1.99	3.10	-	-	13.5 (3.5-16.0)	3.44 (0.7-4.41)	3.92	
7	7	9	18	18	-	-	1.60	1.60	2.06	4.12	-	-	13.5 (3.5-16.0)	3.45 (0.7-4.41)	3.91	
7	7	12	12	12	-	-	1.89	1.89	3.24	3.24	-	-	13.5 (3.5-16.0)	3.48 (0.7-4.41)	3.88	
7	7	12	12	14	-	-	1.82	1.82	3.12	3.62	-	-	13.5 (3.5-16.0)	3.47 (0.7-4.41)	3.89	
7	7	12	12	18	-	-	1.69	1.69	2.89	4.34	-	-	13.5 (3.5-16.0)	3.46 (0.7-4.41)	3.90	
7	7	12	12	24	-	-	1.52	1.52	2.61	5.24	-	-	13.5 (3.5-16.0)	3.44 (0.7-4.41)	3.92	
7	7	12	14	14	-	-	1.75	1.75	3.00	3.50	-	-	13.5 (3.5-16.0)	3.46 (0.7-4.41)	3.90	
7	7	12	14	18	-	-	1.63	1.63	2.79	4.19	-	-	13.5 (3.5-16.0)	3.45 (0.7-4.41)	3.91	
7	7	12	18	18	-	-	1.52	1.52	2.62	3.92	-	-	13.5 (3.5-16.0)	3.44 (0.7-4.41)	3.92	
7	7	14	14	14	-	-	1.68	1.68	3.38	3.38	-	-	13.5 (3.5-16.0)	3.46 (0.7-4.41)	3.90	
7	7	14	14	18	-	-	1.58	1.58	3.15	4.04	-	-	13.5 (3.5-16.0)	3.45 (0.7-4.41)	3.91	
7	9	9	9	9	-	-	2.18	2.18	2.78	2.78	-	-	13.3 (3.5-15.6)	3.44 (0.7-4.30)	3.87	
7	9	9	9	12	-	-	2.05	2.05	2.64	3.53	-	-	13.5 (3			



Feature Summary

Type	Wall-Mounted				Wall-Mounted			
Series	Designer series	Standard series		Standard series	Designer series	Standard series		
Model name								
Refrigerant	R32				R410A			
Energy-saving Features	Save Occupancy sensor	●						
	Economy operation	●	●	●	●	●	●	
	Setting temperature range limitation	●	○	○	○	○	○	
	Set temperature auto return	○	○		○	○	○	
Features for Comfort	Power diffuser					●	●	
	Powerful operation	●	●	●	●			
	10°C Heat	●	●	●	●			
	Outdoor unit low noise operation							
	Auto changeover	●	●	●	●	●	●	
	UP/DOWN swing louver	●	●	●	●	●	●	
	Double swing automatic	●			●		●	
	Automatic fan speed	●	●	●	●	●	●	
	Auto restart	●	●	●	●	●	●	
	Connectable fresh air duct							
	Fresh air intake							
	Connectable distributing duct							
	Individual airflow direction control							
	Convenience Features	Auto-off timer	○	○		○	○	○
Sleep timer		●	●	●	●	●	●	
Program timer		●	●	●	●	●	●	
Weekly timer		●	●*	●*	●	●	○	
Weekly & Temperature setback timer		○	○		○	○	○	
Filter sign		●	●	●	●	●	●	
External error output		○	○		○	○	○	
External ON/OFF input		○	○		○	○	○	
Wireless LAN control		● (KJCAL, KJCALB), ○ (KJCA, KJCA-B)	● (KMCG, KMCG-B), ○ (KMCF)	●	●	○	○	
Individual auto		●						
Clean Features	Ion deodorization filter	●	●		●	●	●	
	Apple-catechin filter	●	●		●	●	●	
	Long-life filter							
	Washable panel	●	●	●	●		●	
	Silver Ion Filter	○	○	○	○	○	○	
	Heat Clean							
Installation / Support	Automatic airflow adjustment							
	Drain pump as standard							
	Refrigerant cycle monitor							

○ : Optional function

*: It is only available on the AIRSTAGE Mobile application. It can not be used via wireless remote controller.



Feature Summary

Type	Cassette				Duct			Duct				Floor		Floor/Ceiling	Ceiling			
Series	Compact cassette	Circular flow cassette	Compact 4-way Flow Series	4-way Flow Series	Mini (With drain pump)		Slim (With drain pump)	Medium Static Pressure										
Model name																		
Refrigerant	AUXG 07/09/12/14/18/22/24 KVLA	AUXG 18/22/24/30/36/45 KRLB	AUHG07/09LVLA, AUHG12/14/18LVLB, AUHG22/24LVLA	AUHG30/36LRLE, AUHG36/45LRLA	ARXG 07/09/12/14/18 KSLAP	ARHG 07/09/12/14/18 LSLAP	ARXG 07/09/12/14/18 KLLAP	ARHG07/09LLTA, ARHG12/14/18LLTB	ARXH 12/14/18/22/24/30/36/45 KMTAP	ARXG22KMLB, ARXG 24/30/36/45 KMLA	ARHG 22/24/36/45 LMLA, ARHG 30/36LMLE	AGHG 09/12/14 KVCA	AGHG 09/12/14 LVCA	ABHG 14/22/24 LVTA, ABHG18LVTB	ABHG18/22KRTA	ABHG30/36LRTE, ABHG36/45LRTA		
Energy-saving Features	Save Occupancy sensor																	
	Economy operation	●	●	●	●	●	●	●	○	●	●	●	●	●	●	●	●	
	Setting temperature range limitation	○	●	○	○	●	●	○	○	○	○	○	○	○	○	●	○	
	Set temperature auto return	●	●	○	○	●	●	●	○	○	●	○	○	○	○	●	○	
Features for Comfort	Power diffuser																	
	Powerful operation												●					
	10°C Heat	●	○	●	○	○	○	○	○	○	○	○	●	●	●	○	●	
	Outdoor unit low noise operation		○ (45)										●		○	○	○ (45/54)(36LRTA)	
	Auto changeover	●	●	●	●	●	●	●	●	●	●	●	●	●	●	●	●	●
	UP/DOWN swing louver	●	●	●	●	○	○	○	○				●	●		●		
	Double swing automatic														●		●	
	Automatic fan speed	●	●	●	●	●	●	●	●	●	●	●	●	●	●	●	●	●
	Auto restart	●	●	●	●	●	●	●	●	●	●	●	●	●	●	●	●	●
	Connectable fresh air duct		●	○	●					●	●	●				●	●	
Fresh air intake	○	○	○	○			○	○	○	○	○				○	○		
Connectable distributing duct		●							●	●								
Individual airflow direction control		●																
Convenience Features	Auto-off timer	●	●	○	○	●	●	●	○	●	●	○	○	○	○	●	○	
	Sleep timer	●	○	●	○	○	○	○	○	○	○	○	●	●	●	○	●	
	Program timer	●	○	●	○	○	○	○	○	●	○	○	●	●	●	○	●	
	Weekly timer	●	●			●	●	●		○	●		●			●		
	Weekly & Temperature setback timer	○		○	●			●		●	●	●		○	○		○	
	Filter sign	●	●	●	●	●	●	●	●	●	●	●	●	●	●	●	●	●
	External error output		○			○	○			●			○			○		
	External ON/OFF input	●	●	○	○	●	●	●	○	●	●	○	○	○	○	●	○	
Wireless LAN control	○	○	○	○	○	○	○	○	○	○	○	○	○	○	○	○		
Clean Features	Individual auto																	
	Ion deodorization filter											●	●					
	Apple-catechin filter											●	●					
	Long-life filter								○	○	○	●	●					
	Washable panel																	
Installation / Support	Silver Ion Filter	○	○	○	○	○	○	○	○	○	○	○	○	○				
	Heat Clean																	
	Automatic airflow adjustment								●									
	Drain pump as standard	●	●	●	●	●	●	●	●	●	○	○				○	○	
Refrigerant cycle monitor									○									

○: Optional function