

## Light Commercial & Commercial, Residential

# VRF

VRF systems provide air conditioning solutions that meet the requirements of a diverse range of buildings.

V-002 VRF series Overview  
V-004 Features

### R32 VRF Outdoor unit



VRF J series  
Heat Pump for Small-capacity type

V-022 VRF J-VS  
V-028 VRF J-VL



VRF V series  
Heat Recovery Modular type  
Heat Pump Modular type

V-032 VRF VU-V

### R32 VRF Indoor unit

V-050 VRF Indoor Unit Lineup  
for J-VS, J-VL, VU-V

### R410A VRF Outdoor unit



VRF J series  
Heat Pump for Small-capacity type

V-072 VRF J-IVS  
V-076 VRF J-IV  
V-080 VRF J-IVL



VRF V series  
Heat Recovery Modular type  
Heat Pump Modular type

V-086 VRF VR-IV

V-096 VRF V-IV

### R410A VRF Indoor unit

V-104 VRF Indoor Unit Lineup  
for J-IVS, J-IV, J-IVL, VR-IV, V-IV

## VRF

Light Commercial  
& Commercial,  
Residential



GENERAL HVAC Solutions Euro GmbH  
participates in the ECP program for VRF.  
Check ongoing validity of certificate:  
[www.eurovent-certification.com](http://www.eurovent-certification.com)



# R32 Features

## Sustainable

### Low GWP to A Wide Range of Projects

We are continuously working to develop products that use R32 refrigerant and have R32 products in all product categories in our lineup (Split, Multi-Split, VRF, and ATW).

This allows us to realize environmentally and regulatory friendly system designs for a wide range of projects from residential to light commercial.

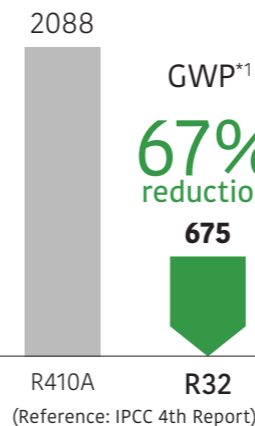

### R32 Refrigerant with Reduced Global Warming Potential

- High environmental properties
- High performance
- Economically efficient

\*1 GWP (Global Warming Potential): a measurement that indicates how much other greenhouse gases are capable of warming the Earth based on carbon dioxide. This is the integrated value of radiant energy given to the Earth (i.e., the estimated impact on global warming) expressed as a ratio to CO2.



### Efforts and Evaluation of CO2 Emissions Reduction

GENERAL HVAC Solutions UK Limited (GUK) has earned Embodied Carbon\* Verification (ECV TM65) for its award-winning J-VS Mini VRF R32 series. TM65 is a third-party certification in the UK that calculates the embodied carbon—CO2 emissions generated during the manufacturing, transportation of products and Operational life cycle.

Based on the assessment standards set by the Chartered Institution of Building Services Engineers (CIBSE), it serves as a key indicator for customers when selecting equipment.

It drives improvements in our manufacturing processes, supports lifecycle impact assessment, and allows architects and engineers to make informed, sustainability-focused decisions for net-zero design.

\*Embodied carbon refers to the total CO2 emissions associated with all stages of a product's lifecycle, including material sourcing, transportation, installation, and disposal.



Actual certificate



# High-Efficiency



High-efficiency is achieved significantly by the use of a scroll compressor, inverter technology, and a large heat exchanger.



NEW Scroll compressor

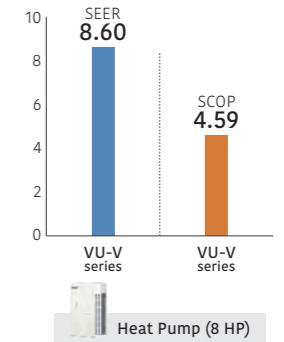

\* These specifications are determined by cassette combination.

## High-Efficiency Design with Top-Class SEER/SCOP

All the VRF series have DC technology to achieve high-efficiency operation. This enhances the durability and reliability of the VRF series.

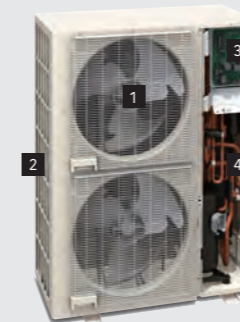

J-VL series

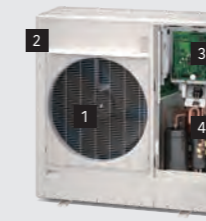





J-VS series

 1 DC fan motor	 3 DC inverter control
 2 Large heat exchanger	 4 Subcooling heat exchanger



VU-V series

 1 3-phase DC fan motor	 3 Sine-wave DC inverter control
 2 Powerful large propeller fan	 4 Subcooling heat exchanger

# Design Flexibility

## Class-Leading Compact Design

An industry-leading compact outdoor unit with optimal airflow pattern design. (Up to 18 HP)

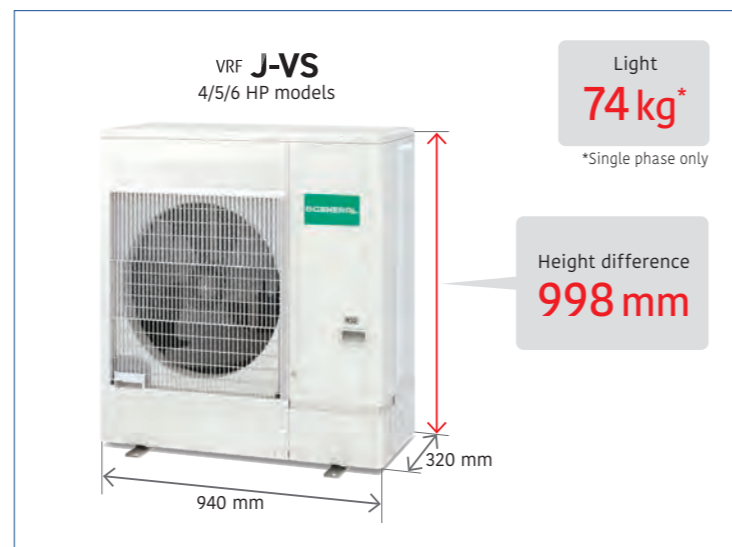

J-VS outdoor units in this series are much more compact than conventional outdoor units of comparable capacity. They can be installed on a balcony, fitting below the height of the railing. With a height of less than 1 m, they can be installed in tight spaces such as under windows.



VRF **J-VL**  
14/16/18 HP models

VRF **J-VL**  
8/10/12 HP models

Current model VRF V series outdoor unit 14/16 HP models

Current model VRF V series outdoor unit 8/10 HP models

765 mm  
480 mm

1,690 mm  
1,428 mm

Height difference **-262mm**  
Compared with current 8 HP model

Depth difference **-285mm**  
J-VL all models  
Compared with current all models

Space requirement **-45%!**  
Compared with current 14/16 HP models

Weight **-62 kg!**  
Compared with current 16 HP model

Space requirement **-26%!**  
Compared with current 8/10 HP models



## High external static pressure

The outdoor unit's external static pressure is adjustable up to 110 Pa (VU-V: 18/20/22 HP). This facilitates mechanical room and hood installations.

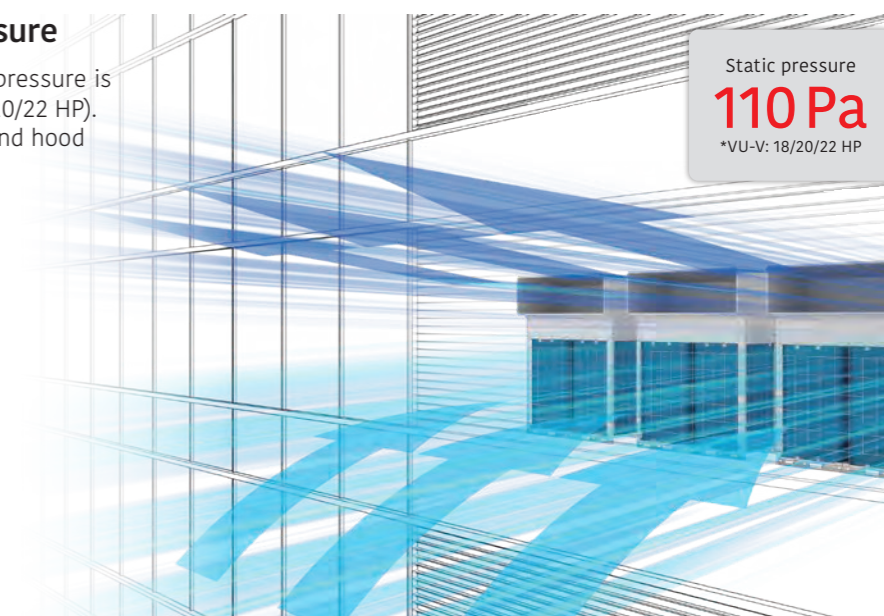

## Extended operating range for ambient temperature

Extended operable ambient temperature enables an offer to different regions with different temperature condition.

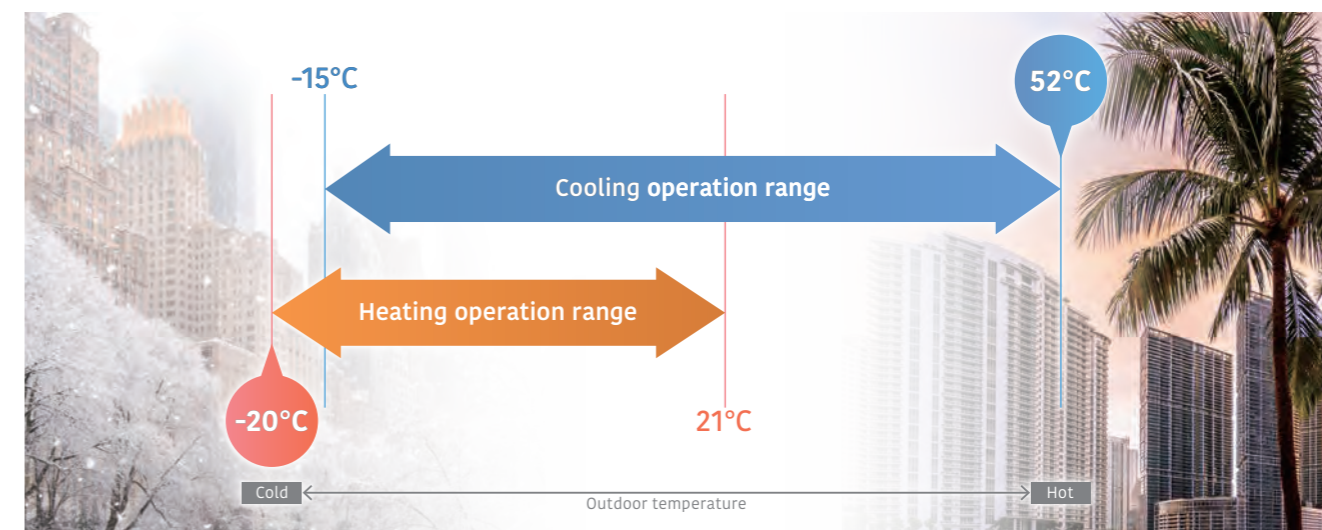

\*Operating temperature range for standalone VU-V heat pumps. The cooling operating temperature range for combination heat pumps is -5°C to 52°C.

# Safety Measures

The environment requiring safety measures is determined by the size of the room in relation to the amount of refrigerant required. You can select refrigerant leak safety measures tailored to each operating environment.



## CASE 1 When using the optional gas sensor

The optional gas sensor kit includes a refrigerant leak detector compatible with R32 refrigerant. The system is designed to meet the environmental safety requirements specified in the IEC 603352-40 standard for the use of R32 refrigerant.

### Operating flow example

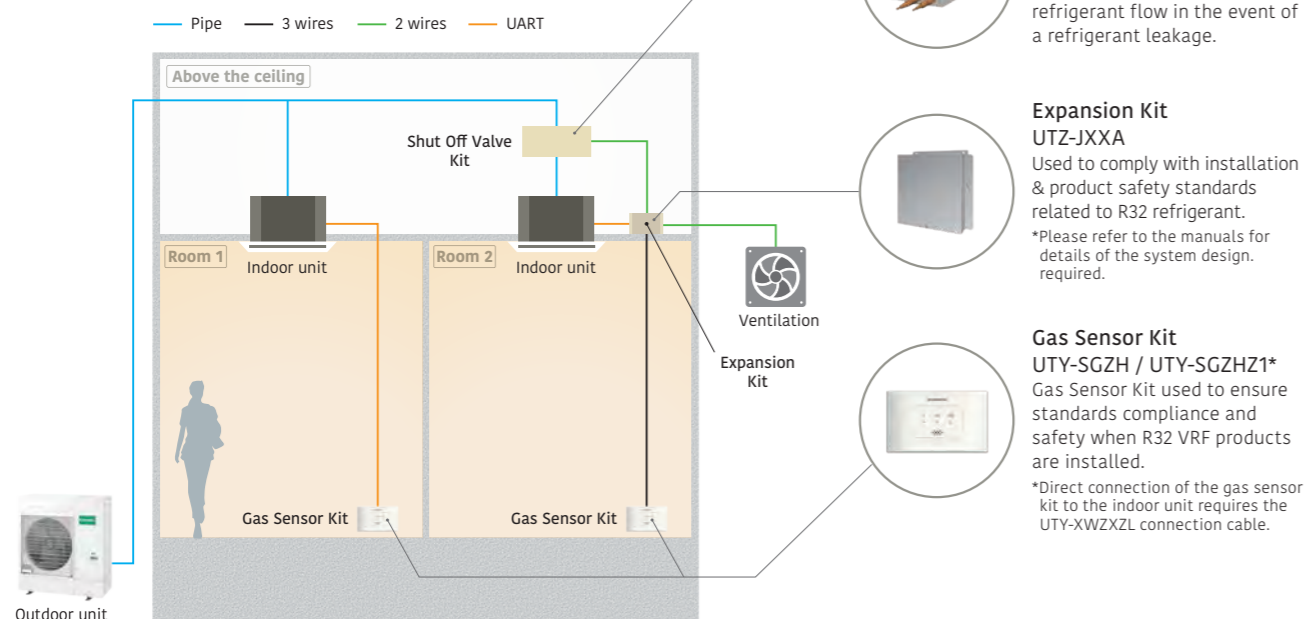

## CASE 2 When using the indoor unit as a sensor

Indoor units compatible with R32 refrigerant are equipped with a refrigerant leak detector. (Some indoor units require optional purchase.) Depending on the conditions of the room where the indoor unit is installed, countermeasures can be implemented using detection equipment.\*1

When activated, the refrigerant leak detector triggers the “Shut off valve kit” and “Wired Remote Controller” to operate simultaneously. This notifies the user or administrator of a refrigerant leak while simultaneously stopping refrigerant circulation.

### Operating flow example

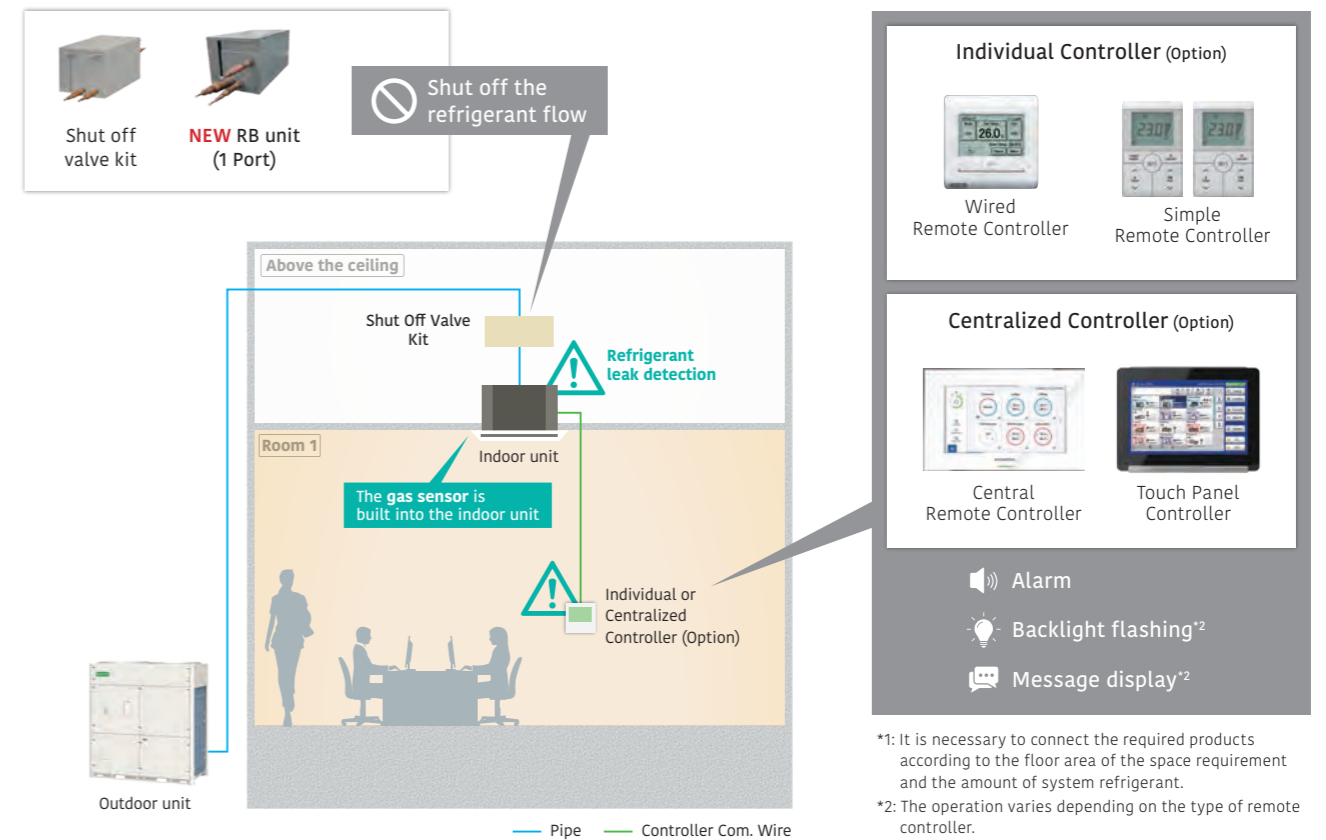



# R32 & R410A Features

## Intelligent Refrigerant Control

General is proposing outdoor units equipped with refrigerant control function. The refrigerant control operates with subtle control corresponding to the heat load of the room and offers a more comfortable environment. The refrigerant control can also provide increased energy savings.



The outdoor unit provides sufficient capacity to meet the demands of the indoor unit.

\* The improvements due to the control and the actual sine wave vary depending on the combination of the indoor unit and system operating conditions.

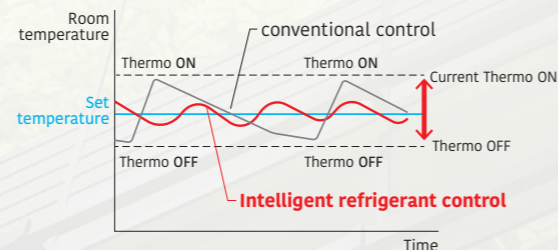

The thermostat is turned on and off less frequently than under conventional control to maintain the room temperature at the target temperature. Compared to conventional control, the compressor will run longer, thus saving energy.

## High-Efficiency

### Efficient Control of Operation

#### Setting Temperature Range Limitation

Sets the minimum and maximum limits on room temperature to establish an optimum balance between energy-saving performance and a comfortable environment.

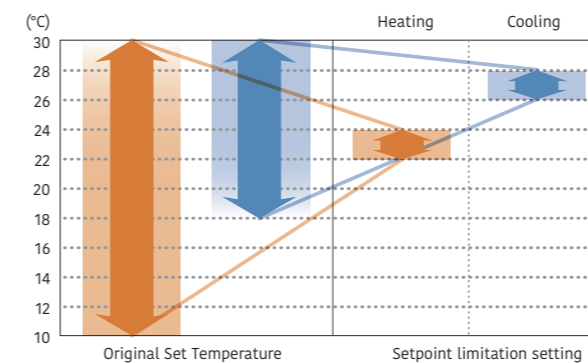

#### Auto-Off Timer

The wired remote controller is equipped with an auto-off timer function that automatically stops operation after a fixed period of time has elapsed from the start of operation to avoid wasting energy. The function also allows you to set the interval for stopping operations.

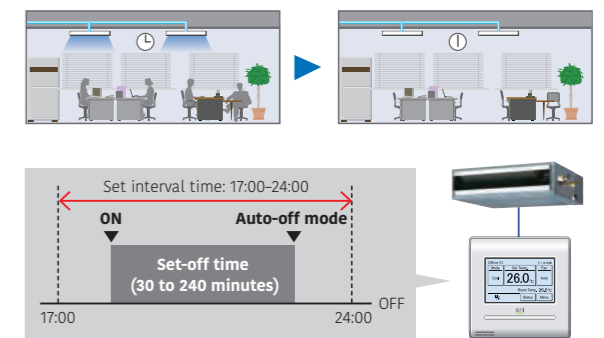

#### Energy-Saving Management

A variety of energy-saving operations can be set and managed depending on the season, climate, and time period. Excellent energy-saving operation using the system controller.

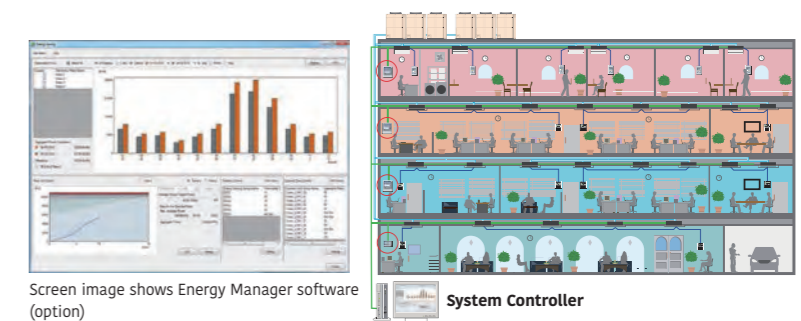

Screen image shows Energy Manager software (option)

System Controller

#### Capacity-Saving Mode

Operation capacity can be reduced in 5 steps from the rated capacity. This mode cuts down on peak power consumption and eases the maximum load on the unit.

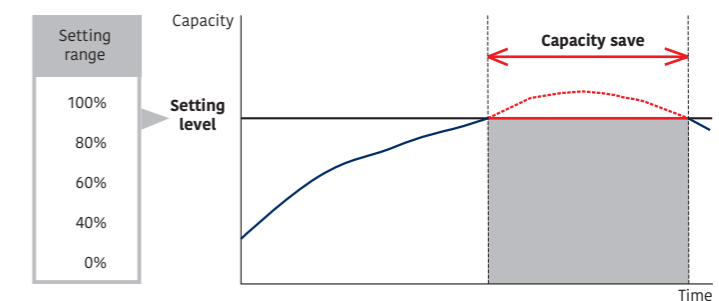

# More Comfort



## Auto Changeover

In Auto setting, the air conditioner switches between cooling and heating modes automatically according to the set temperature and the room temperature.

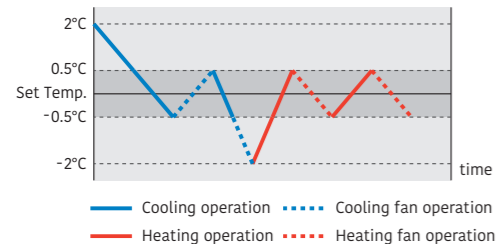

Auto changeover settings enable the indoor unit to easily switch between cooling and heating regardless of the operating mode of other indoor units. These settings can be made using a wired remote controller for a specific indoor unit. Provides a comfortable environment all year round.

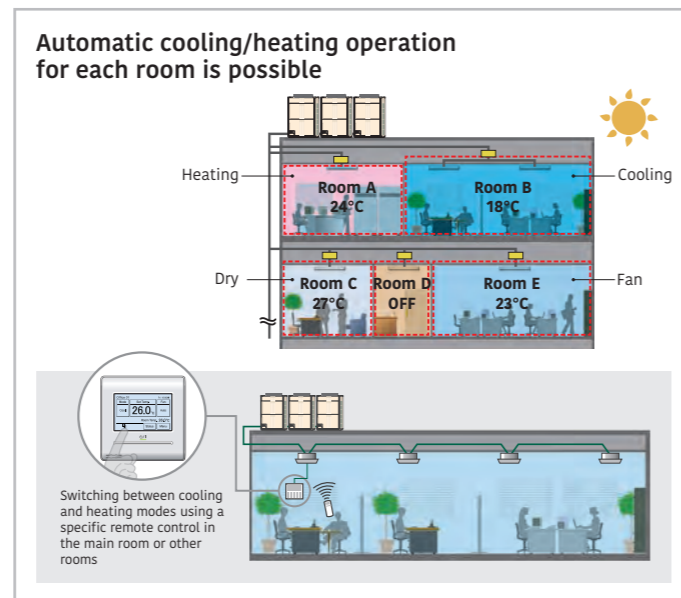

## Precise Control of Refrigerant Flow

The combination of DC inverter control and individual control of electronic expansion valves of an indoor unit enables precise and smooth control of the refrigerant flow. This means the room temperature can be set in increments of 0.5°C.

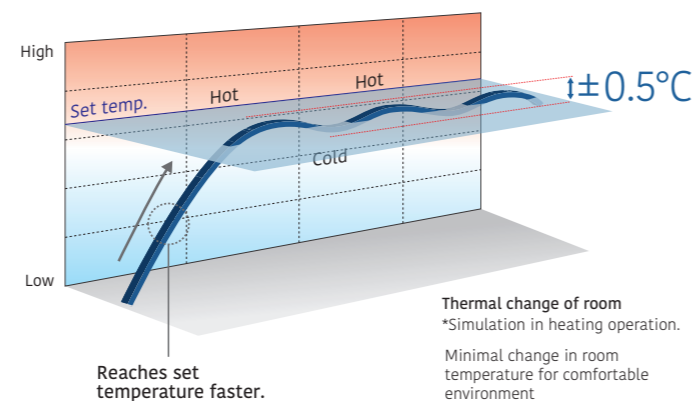

## Quiet Operation

### Quiet Operation

Two low noise modes can be switched over automatically between one in which low noise is prioritized over performance, and the other in which performance is prioritized over low noise, depending on the room temperature and outdoor temperature. This feature can be controlled by external input from the outdoor unit or a system controller.

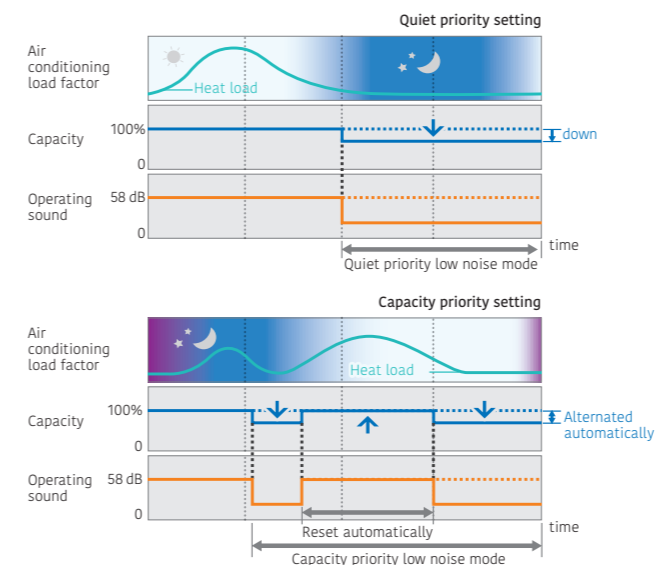

### Non-Stop Oil Recovery Operation

A comfortable room condition is maintained during oil recovery mode because the product continues to operate without stopping the cooling or heating operation.

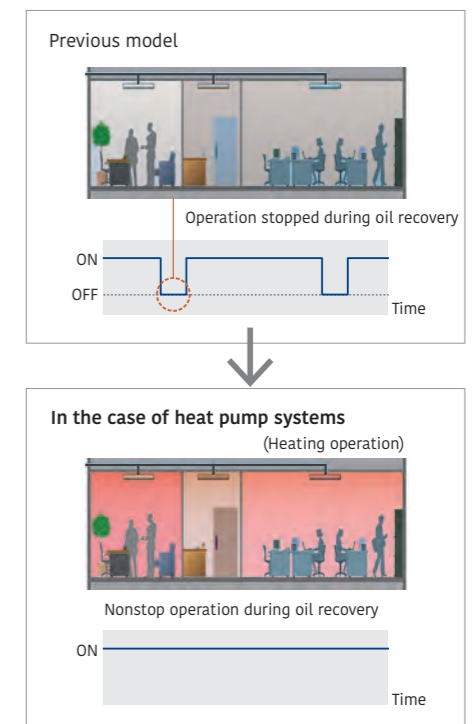

## Switching Room Temperature Sensing Position for Improved Heating Comfort (Option)

The optional Remote Sensor Kit (UTY-XSZXZ1) can be connected to the indoor unit to improve comfort by installing the unit at a height appropriate for the living environment.

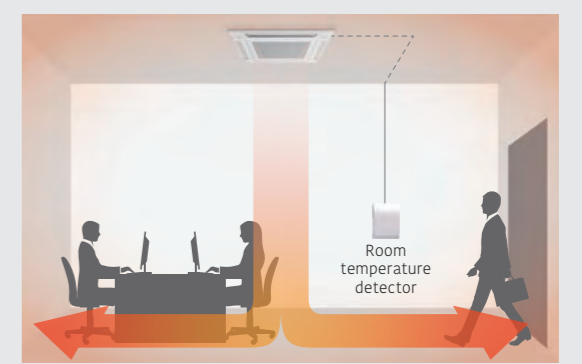

# High Reliability

## Outdoor Unit Rotation

The compressor starting order is rotated to equalize the cumulative running time of each unit.

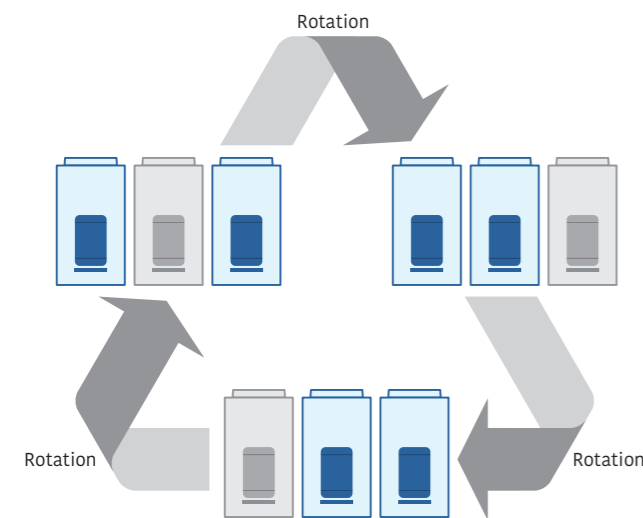

The start and stop timings are alternated among connected compressors.

## Backup Operation

If one compressor fails, the other compressors will initiate backup operation\*.

Note: Backup operation may not be possible depending on the cause of failure.

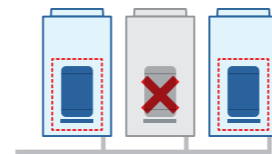

## Advanced Refrigerant Control

Compressor control logic controls the inverter speed to balance the mass airflow rate of refrigerant in each outdoor unit.

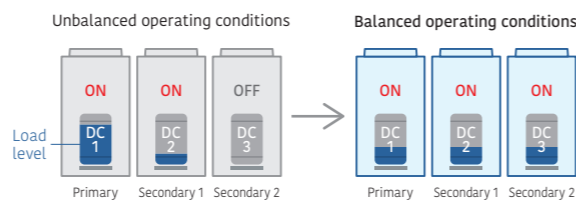

\*VU-V can be connected up to two units.

## Protection Against Liquid Flowback

The use of a large accumulator means that refrigerant that has not been completely vaporized stays inside the accumulator to ensure no liquid refrigerant is fed into the compressor.

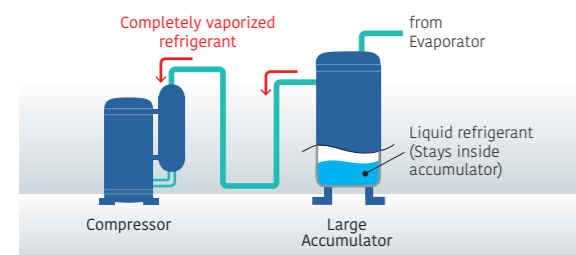

## Blue Fin Heat Exchanger

The anti-corrosion blue fin treatment is applied to the heat exchanger of the outdoor unit.

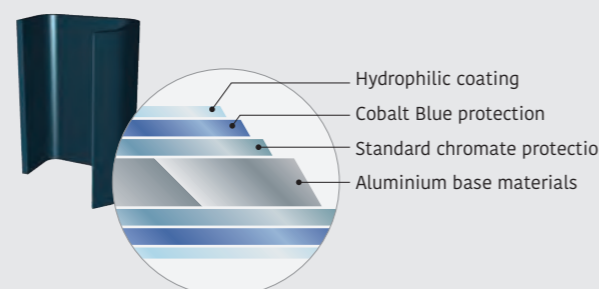

# Design Flexibility

## Long Pipe Design

Pipe design suitable for long and narrow office buildings with elevation differences and low-rise stores with long distances (VRF J-VL series)

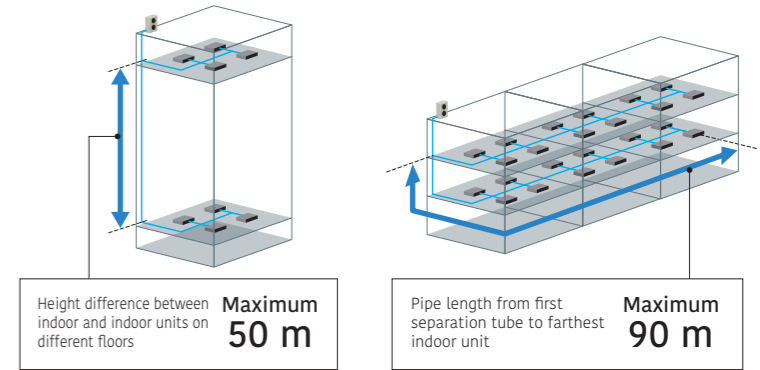

## Max. Allowable Overall Pipe Length: 1,000 m

The class-leading pipe length of 1,000 m increases flexibility of installation in a wide variety of buildings. (VRF VU-V series)

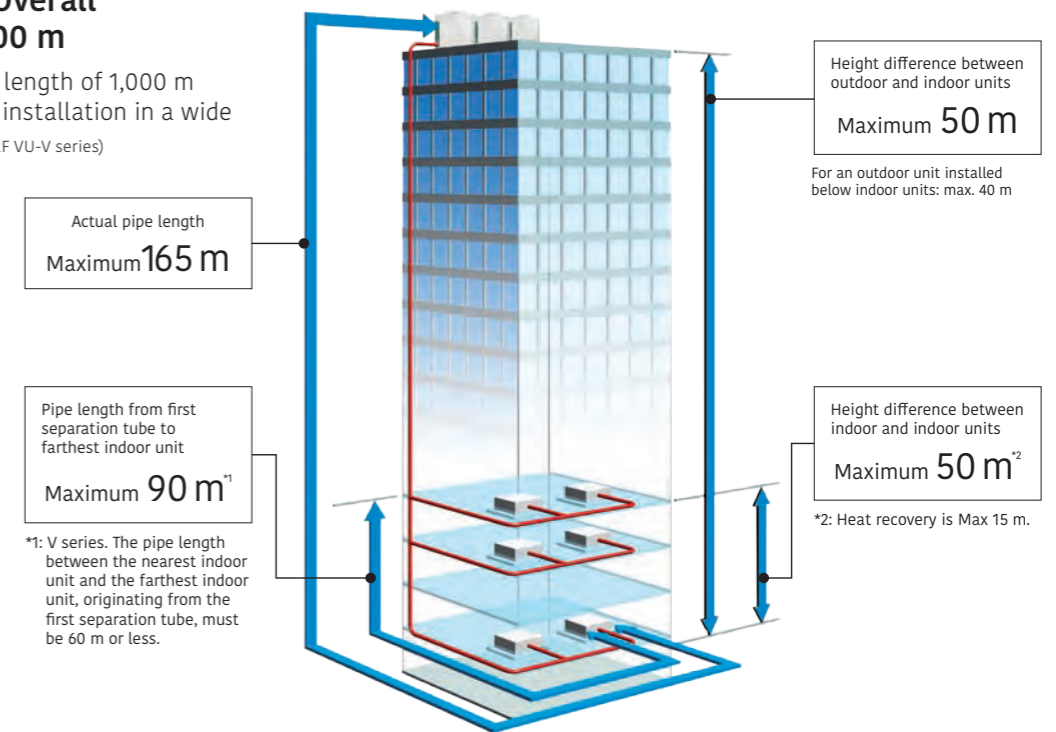

## High-Capacity Connection

	R32	R410A	Connectable indoor unit capacity range	Connectable indoor units
	VRF J-VS series Heat pump type	VRF J-IVS series Heat pump type	50% to 130%	up to 13 <sup>*3</sup>
	VRF J-VL series 8/10/12 HP Heat pump type	VRF J-IVL series 8/10/12 HP Heat pump type	50% to 150%	up to 14 <sup>*3</sup>
	VRF J-VL series 14/16/18 HP Heat pump type	VRF J-IVL series 14/16/18 HP Heat pump type	50% to 150%	up to 30 <sup>*4</sup>
	VRF VU-V series Heat Recovery Modular type	VRF V-IV series Heat Recovery Modular type	25% <sup>*6</sup> to 150%	up to 64
	VRF VU-V series Heat Pump Modular type	VRF V-IV series Heat Pump Modular type	50% to 150%	up to 64

\*3: 6 HP only. \*4: 12 HP only. \*5: 18 HP only. \*6: For modular type, 25% to 49.9% operation in the entire system is available. (by one unit operation)



# Easy Installation



## Simplified Wiring Work

The communication wiring can be installed seamlessly among indoor, outdoor, and RB units, which makes the installation of the wiring system easier.

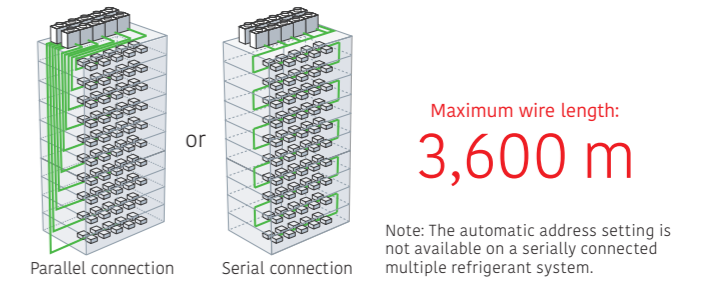

## Vacuum Mode Function for Easy Evacuation

The vacuum mode function enables all expansion valves of an indoor unit to be opened fully, allowing for easier evacuation of air inside pipe lines and indoor units.

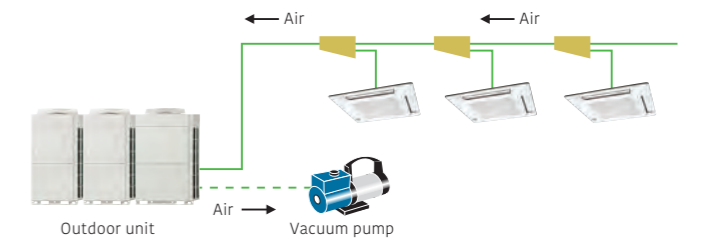

## Easily Transported

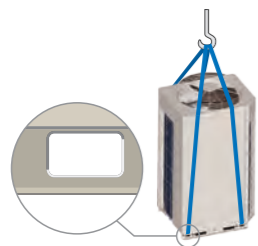

A lifting strap can be hooked onto an outdoor unit. Design of outdoor unit allows for lifting straps to be used.

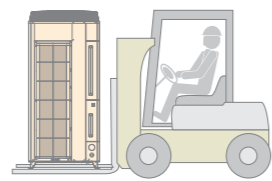

Transportable by forklift. The outdoor unit can be lifted and transported by forklift.

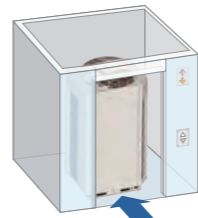

Fits into a small elevator.

## Automatic Address Setting

Addresses of connected indoor units, RB units, and Signal amplifier can all be set automatically from the PCB in the outdoor unit.

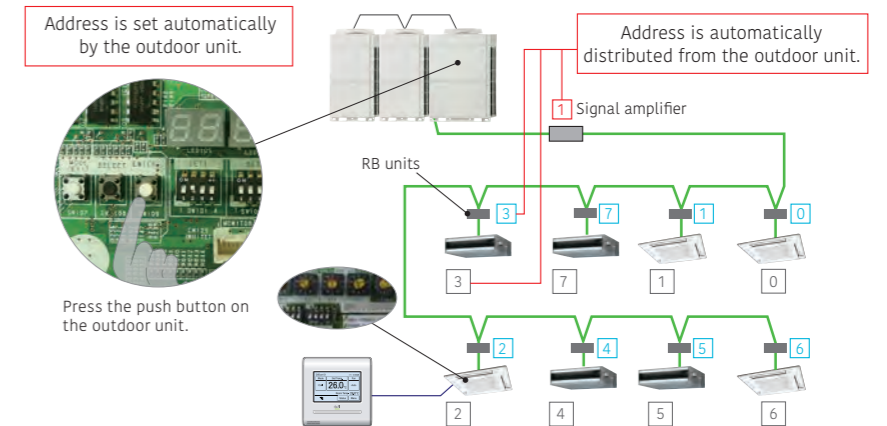

## Easy Access

The removable L-shaped front panel provides more room for installation and service work. Multiple installations can be performed easily and efficiently even in tight spaces.

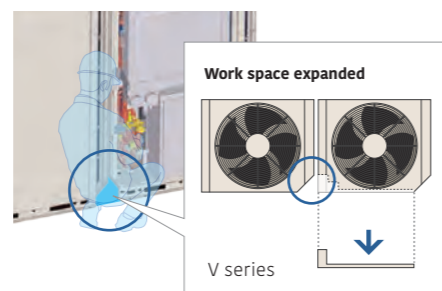

Front access reduces installation intervals.

## Flexible Pipe Connection

Pipe and wire can be accessed from the front, left, right, and bottom.

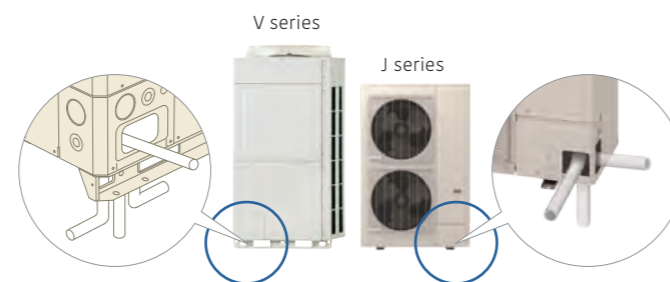

## Easy Commissioning with Tools

### • Service Tool (UTY-ASGXZ1)

The Service Tool checks the refrigerant temperature and pressure, and the operating status of the electronic expansion valves, making it easy to determine if the units are connected properly.

### • Central Remote Controller (UTY-DCGGZ4)

After the VRF system has been installed. Conveniently, the "test run" required to verify proper system operation can be performed from a nearby Central RC.

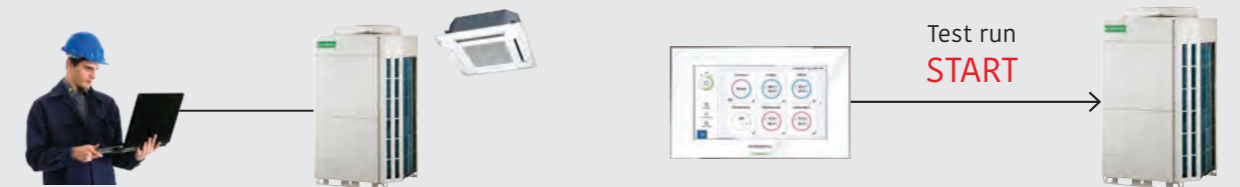

# Easy Service and Maintenance

## Designed for Easy Maintenance

A 7-segment indicator lamp panel provides detailed information on the function setting status, refrigerant temperature and pressure, compressor operation time, and other factors, facilitating self-diagnosis for each unit.

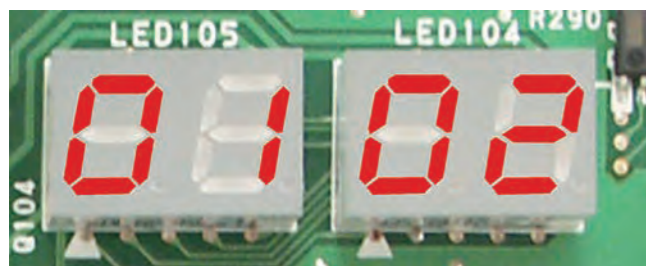

### Easy-to-read 7-segment indicator lamp

Shows the following detailed operation and error status without need of any others tools.

### Error status can be checked on an outdoor unit's display

- System operation mode
- Discharge temperature and pressure
- Compressor operation status
- Address, type, and number of outdoor unit

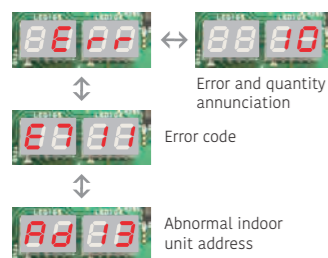

• Error status can easily be checked on an outdoor unit's display.

### Movable PCB panel

Enables easier access behind the PCB for maintenance work.



## The Error Status can be Checked Via a Wired Remote Controller for Indoor Units.

Error codes are displayed on an LCD screen.

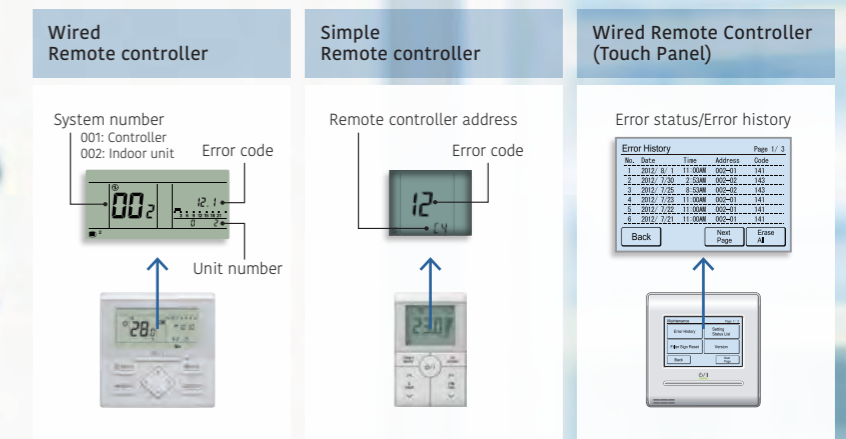

## Error Diagnosis by Service Tool

### Connection to Service tool

- A detailed operation status and recent error history can be checked and analyzed using Service tool.
- The last 5 minutes of operation status can be recorded continuously.

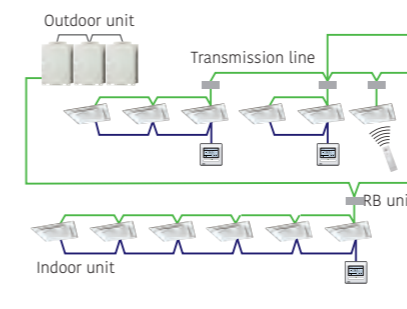

## Remote monitoring / Remote operation

The central remote controller can control your tenant's air conditioner anytime and anywhere. When the central remote controller manages the indoor units of some tenants, air conditioning of each tenant can be managed separately online.

### Increased the Number of Accounts

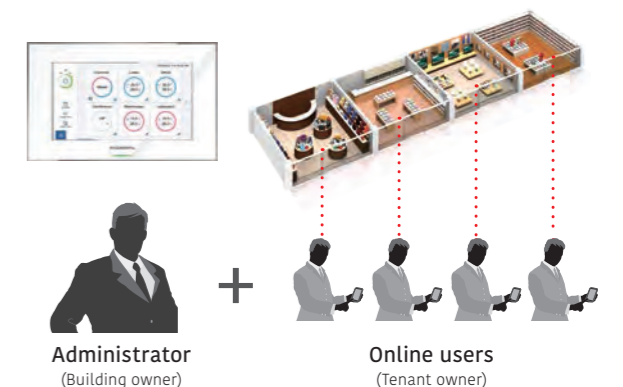



# VRF R32 OUTDOOR UNITS

3 types and 37 models are available to meet the requirements of any building design.

We offer a wide lineup of outdoor units suitable for everything from small properties like apartments to large commercial facilities and buildings.

V-020 VRF R32 Outdoor Units Lineup for J-VS J-VL VU-V

V-022 VRF J-VS

V-028 VRF J-VL

V-032 VRF VU-V



# VRF R32 Outdoor Units Lineup for J-VS J-VL VU-V

Capacity (kW)	Refrigerant	12.1	14	15.1-15.5	22.4	28	33.5	40	45	50.0-50.4	55.9	61.5	67	73.5	78.5	85	90	95	100.5	107	112	118.5	123.5	
HP		4	5	6	8	10	12	14	16	18	20	22	24	26	28	30	32	34	36	38	40	42	44	
<b>J-VS series Heat Pump</b>		 AJH040 KCTAH, AJH040 KFTAH	 AJH045 KCTAH, AJH045 KFTAH	 AJH054 KCTAH, AJH054 KFTAH																				
					 AJH072 KELAH	 AJH090 KELAH	 AJH108 KELAH	 AJH126 KELAH	 AJH144 KELAH	 AJH162 KELAH														
<b>J-VL Series Heat Pump</b>					 AJH072 KELAH	 AJH090 KELAH	 AJH108 KELAH	 AJH126 KELAH	 AJH144 KELAH	 AJH162 KELAH														
					 AJH072 HALAH	 AJH090 HALAH	 AJH108 HALAH	 AJH126 HALAH	 AJH144 HALAH	 AJH162 HALAH	 AJH180 HALAH	 AJH198 HALAH	 AJH216 HALAH	 AJH234 HALAH	 AJH252 HALAH	 AJH270 HALAH	 AJH288 HALAH	 AJH306 HALAH	 AJH324 HALAH	 AJH342 HALAH	 AJH360 HALAH	 AJH378 HALAH	 AJH396 HALAH	
<b>VU-V Series Heat Pump &amp; Heat Recovery</b>					 AJH072 HALAH	 AJH090 HALAH	 AJH108 HALAH	 AJH126 HALAH	 AJH144 HALAH	 AJH162 HALAH	 AJH180 HALAH	 AJH198 HALAH	 AJH216 HALAH	 AJH234 HALAH	 AJH252 HALAH	 AJH270 HALAH	 AJH288 HALAH	 AJH306 HALAH	 AJH324 HALAH	 AJH342 HALAH	 AJH360 HALAH	 AJH378 HALAH	 AJH396 HALAH	
									 AJH144 HALAHH	 AJH162 HALAHH	 AJH180 HALAHH	 AJH198 HALAHH	 AJH216 HALAHH	 AJH252 HALAHH		 AJH288 HALAHH		 AJH324 HALAHH	 AJH342 HALAHH					



**Heat Pump**  
for Small-capacity type

**VRF J-VS**

**System configuration example**

- Suitable for air conditioning small and medium-size buildings. One refrigerant system is used for each outdoor unit.
- Multiple indoor units are connected with separation tubes and headers.

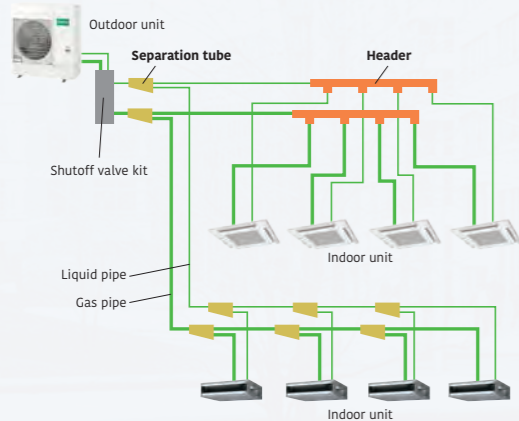

**R32 Refrigerant with Reduced Global Warming Potential**

- High environmental properties
- High performance
- Economically efficient

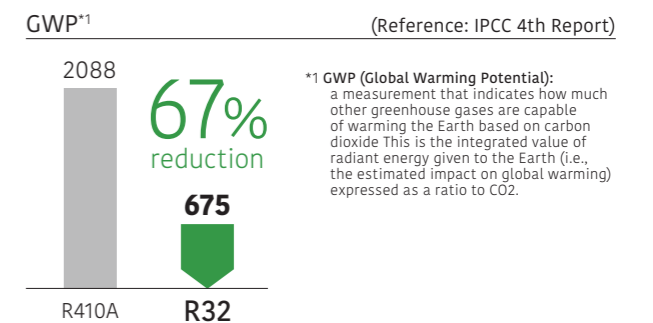

This product uses R32, an environmentally friendly refrigerant. With TOP-class energy efficiency and compact design, it can be installed in a limited and narrow space without being conspicuous.

for **SHOP**

for **LARGE APARTMENT**

for **OFFICE**



**“5S”** Leading to the Optimal Solution



# Sustainable

## European F-Gas Regulation Plan

The European Union has tightened F-gas rules as part of European Green Deal policy, which aims for Europe climate neutral by 2050. The F-gas Regulation mainly includes

- (1) Reducing the total volume of HFCs and phasing out HFC in 2050.
- (2) The GWP limits for certain products are required to be strengthened.

General as one of its proactive efforts to preserve the global environment, we are working on technological development to achieve the best balance between refrigerants with lower GWP and energy efficiency of equipment adopting safety measures.

2029	2033	2035	2050
Available at J-VS			
Split AC & HP Over 12 kW: GWP 750 and above prohibited 12 kW or less: GWP 150 and above prohibited	Split AC & HP Over 12 kW: GWP 150 and above prohibited	Split AC & HP HFC use prohibited	an economy with <b>net-zero</b> greenhouse gas emissions.

## Refrigerant Saving Design

Compact indoor unit, pipe design, and optimization of heat exchanger volume significantly reduce the system refrigerant volume.

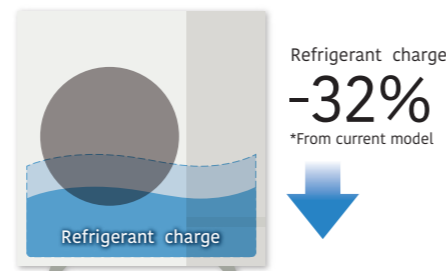

## Enhanced Disaster Safety Measures

The system is designed to meet the environmental safety requirements specified in the IEC 603352-40 standard for the use of R32 refrigerant. The environment requiring safety measures is determined by the size of the room in relation to the amount of refrigerant required. For example, if the system is designed for maximum pipe length and the refrigerant charge is 6 kg, safety measures are required for rooms of 15 m<sup>2</sup> or less.

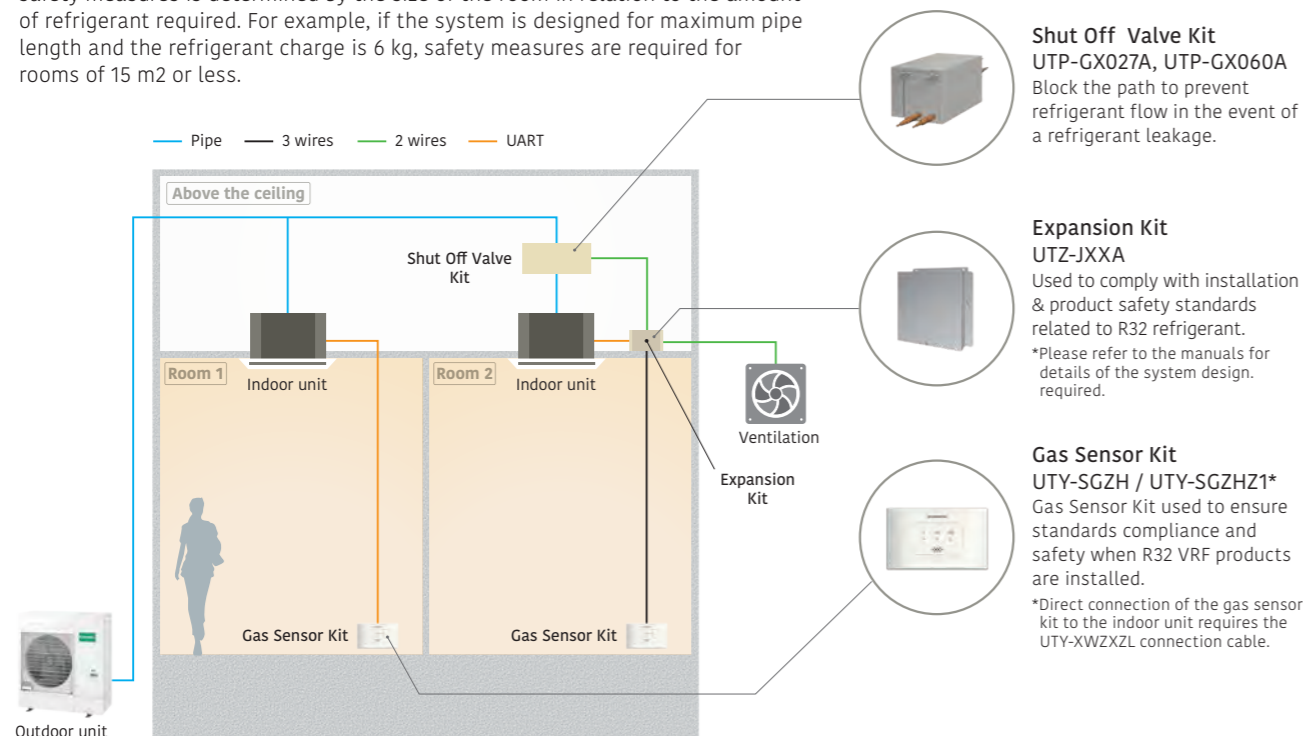

# Saving CO2

## Top-class High Energy Saving

The use of large heat exchanger and a high-efficiency Rotary compressor achieves class-leading SEER/SCOP in all models.

SEER **8.27** \*045 model  
SCOP **5.37** \*040 model

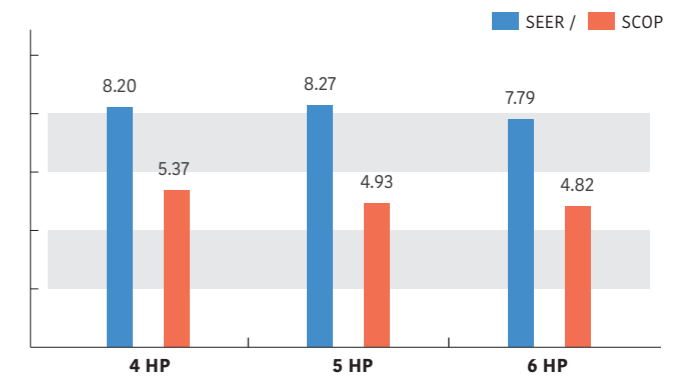

## More Energy-Saving Compressor Control

When the room temperature approaches the set temperature after the start of operation, the capacity required for the outdoor unit becomes lower. The minimum compressor speed at this time can now be controlled at a lower value than with conventional products, enabling more energy-efficient operation.

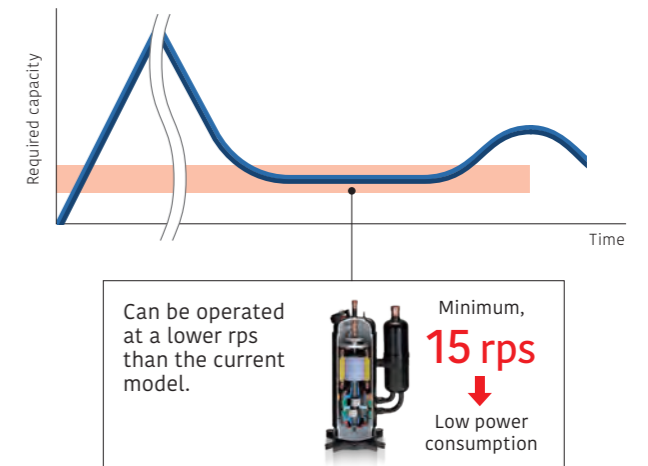

## Small Body

### Easy to Carry, Easy to Install

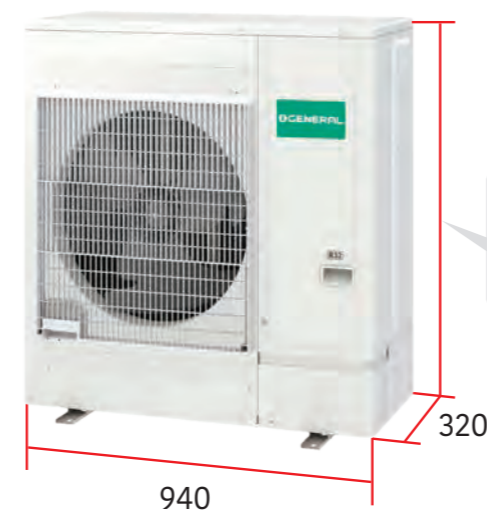

## Small, Lightweight Outdoor Unit

The outdoor units in this series are much more compact than conventional outdoor units of comparable capacity. They can be installed on a balcony, fitting below the height of the railing. With a height of less than 1 m, they can be installed in tight spaces such as under windows.



# Situational Piping Design

## Long Pipe Length

Our advanced refrigerant control technology extends the maximum allowable length of refrigerant pipe to 120 m. This provides high flexibility in system design.

Long pipe lengths are achieved by installing a large-capacity accumulator. No liquid refrigerant is supplied to the compressor even when the required amount of refrigerant is charged in the long pipe.

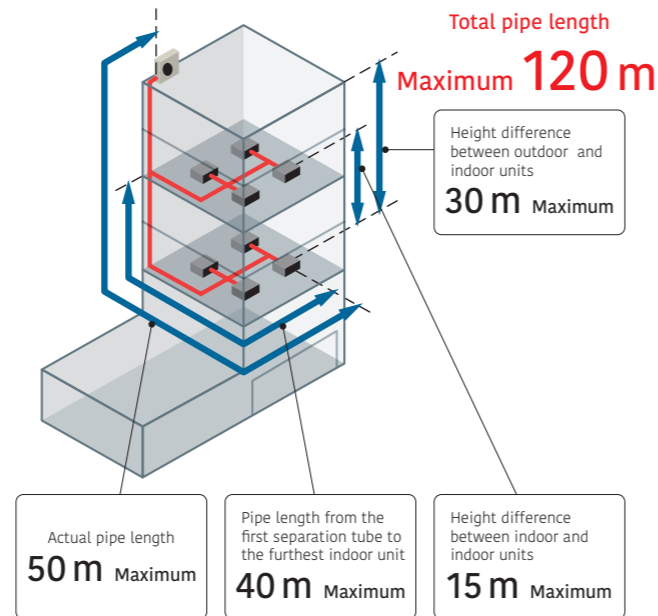
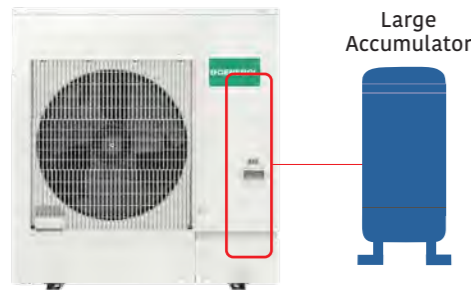

## Up to 13 Indoor Units\* can be Connected

The combination of smaller but sufficiently powerful indoor units and an outdoor unit with an optimized heat exchanging structure makes it possible to connect up to 13 indoor units, which is the best in its class.

\*: 6 HP model

Rating Capacity range (HP)	4	5	6
Max. Connectable indoor unit	1-11	1-12	1-13

## Sightliness Installation

### External Static Pressure

External static pressure measures up to 30 Pa for 4/5/6 HP models.

Even if the outdoor unit is installed in a small space to hide it, the grille and duct airflow path required for exhaust air can be installed up to a static pressure value of 30 Pa.

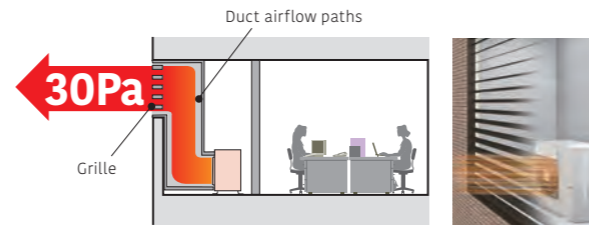

### Cooling Pipe System

Heat Rejection Technology Cooling pipe system "Cooling pipe system" is adopted to ensure reliability in high outside air.

Even when the outdoor unit is installed in an environment where heat tends to stay (small space), the cooling system using refrigerant can reduce damage caused by heat from PCBs.

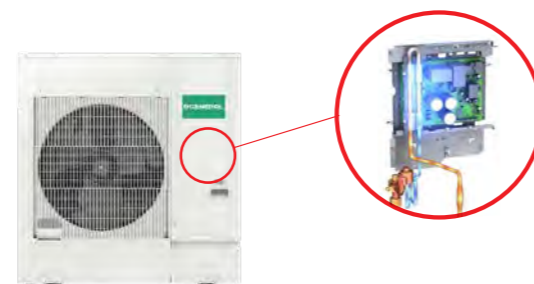

4, 5, 6 HP: AJH040KCTAH / AJH045KCTAH / AJH054KCTAH  
AJH040KFTAHA [3-phase] / AJH045KFTAHA [3-phase] / AJH054KFTAHA [3-phase]



### Specifications

Rated capacity range		HP	4	5	6	4	5	6
Model name			AJH040KCTAH	AJH045KCTAH	AJH054KCTAH	AJH040KFTAHA	AJH045KFTAHA	AJH054KFTAHA
Maximum connectable indoor units			1-11	1-12	1-13	1-11	1-12	1-13
Power source			Single phase, 230V~, 50Hz			3-phase, 400V~, 50Hz		
Capacity	Cooling	kW	12.1	14.0	15.1	12.1	14.0	15.1
	Nominal Heating		12.1	14.0	15.1	12.1	14.0	15.1
	Max. Heating		13.6	16.0	16.5	13.6	16.0	16.5
Input power	Cooling	kW	3.15	3.82	4.48	3.15	3.82	4.48
	Nominal Heating		2.55	2.91	3.20	2.55	2.91	3.20
	Max. Heating		3.09	3.62	3.90	3.09	3.62	3.90
EER	Cooling	W/W	3.84	3.66	3.37	3.84	3.66	3.37
	Nominal Heating		4.74	4.80	4.71	4.74	4.80	4.71
	Max. Heating		4.40	4.41	4.22	4.40	4.41	4.22
SEER	Cooling		8.20	8.27	7.79	8.20	8.27	7.79
	Heating		5.37	4.93	4.82	5.37	4.93	4.82
SCOP	Cooling		325.0	327.8	308.6	325.0	327.8	308.6
	Heating		211.8	194.2	189.8	211.8	194.2	189.8
ηh	Heating	%	4.450	4.450	4.450	4.450	4.450	4.450
Airflow rate		m <sup>3</sup> /h	4,450	4,450	4,450	4,450	4,450	4,450
Sound pressure level/Power level	Cooling	dB(A)	52 / 70	53 / 71	54 / 72	52 / 70	53 / 71	54 / 72
	Heating		54 / 71	55 / 72	56 / 73	54 / 71	55 / 72	56 / 73
Heat exchanger fin			Blue fin	Blue fin	Blue fin	Blue fin	Blue fin	Blue fin
Net Dimensions	Height	mm	998	998	998	998	998	998
	Width		940	940	940	940	940	940
	Depth		320	320	320	320	320	320
Weight		kg	74	74	74	75	75	75
	Refrigerant		Type (Global Warming Potential)	R32 (675)	R32 (675)	R32 (675)	R32 (675)	R32 (675)
Connection pipe diameter	Charge	kg (CO <sub>2</sub> eq-T)	2.7 (1.823)	2.7 (1.823)	2.7 (1.823)	2.7 (1.823)	2.7 (1.823)	2.7 (1.823)
	Liquid		9.52	9.52	9.52	9.52	9.52	9.52
Total pipe length	Gas	mm	15.88	15.88	15.88	15.88	15.88	15.88
			120	120	120	120	120	120
Max. height difference		m	30	30	30	30	30	30
Operating Range	Cooling	°C	-5 to 46	-5 to 46	-5 to 46	-5 to 46	-5 to 46	-5 to 46
	Heating		-20 to 21	-20 to 21	-20 to 21	-20 to 21	-20 to 21	-20 to 21

Note: Specifications are based on the following conditions.  
Cooling: Indoor temperature of 27°CDB/19°CWB, and outdoor temperature of 35°CDB/24°CWB.  
Heating: Indoor temperature of 20°CDB/(15°CWB), and outdoor temperature of 7°CDB/6°CWB.  
Pipe length: 11 m; Height difference between outdoor unit and indoor unit: 0 m.  
The protective function may work when using it outside the operation range.

### Dimensions

(Unit: mm)

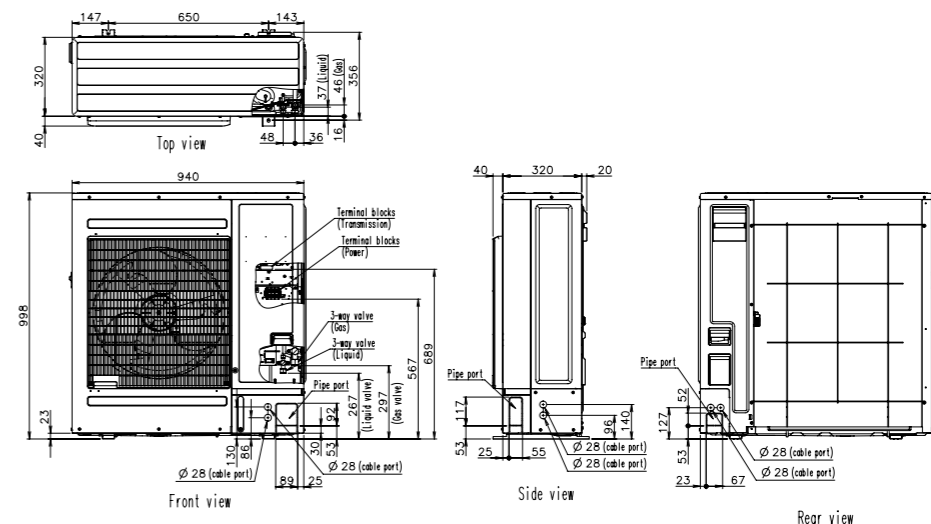



**Heat Pump**  
for Small-capacity type

**VRF J-VL**

**System configuration example**

- Suitable for air conditioning small and medium-size buildings. One refrigerant system is used for each outdoor unit.
- Multiple indoor units are connected with separation tubes and headers.

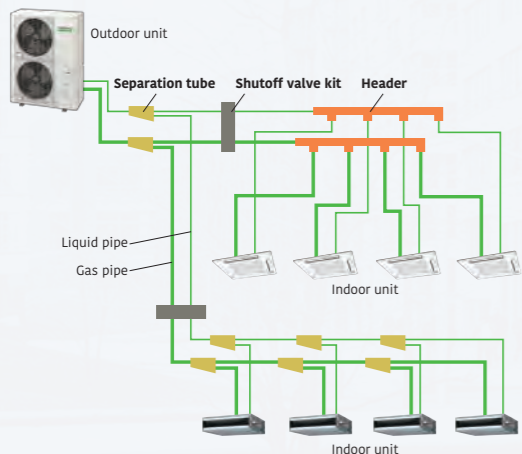

This product uses R32, an environmentally friendly refrigerant. J-VL is an outdoor unit with a slim design. Its flexibility in installation makes it ideal for midsize office buildings and hotels.

for **OFFICE**  
for **Hotel**  
for **SHOP**



**Environmental Considerations**  
High energy saving  
High installation Flexibility



**R32 Refrigerant with Reduced Global Warming Potential**

- High environmental properties
- High performance
- Economically efficient

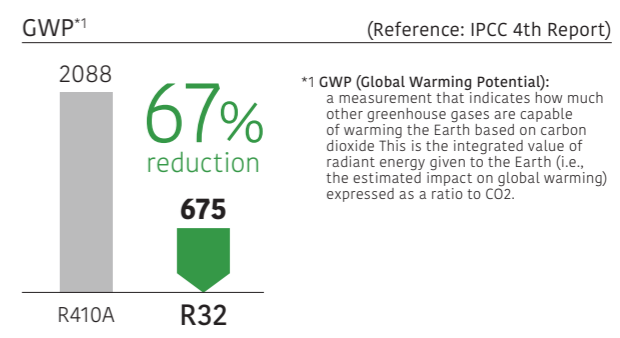

## High Energy Saving

J-VL provides environmentally conscious, high-efficiency operation while ensuring comfort.

Cooling  $\eta_c$

ALL **280.2%** or above

Heating  $\eta_h$

ALL **177.4%** or above

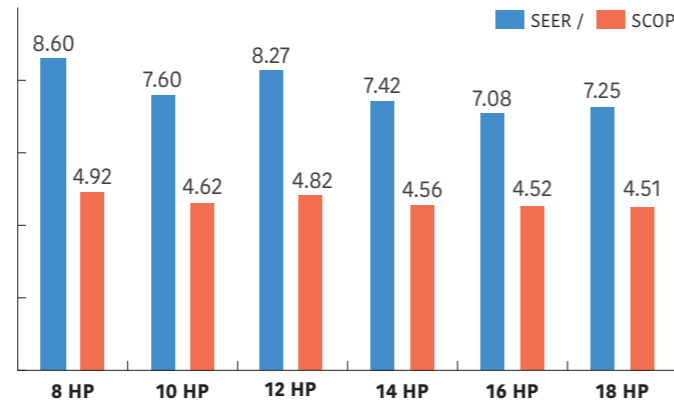

## High installation Flexibility

### Slim design yet large capacity

Slim and space-saving design that can be installed even in narrow spaces, yet offers a large capacity of up to 18HP. Multiple units can be installed flexibly, allowing for high installation freedom.



### Supports concealed installation

Even if the outdoor unit is installed in a small space to hide it, the grille and duct airflow path required for exhaust air can be installed up to a static pressure value of 60 Pa. (40Pa for 8/10/12HP)

\*Capacities slightly decrease relative to the rated values during high static pressure operations.



### Environmentally conscious with low-noise mode

5-steps low-noise modes are available. This allows for detailed noise control in various external environments.

5-steps low noise mode

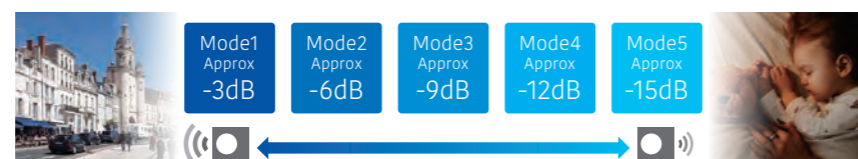

\*When using this function, cooling and heating performance may decrease. The noise reduction value in low-noise mode varies depending on the model.

8,10,12 HP: AJH072KELAH / AJH090KELAH / AJH108KELAH  
14,16,18 HP: AJH126KELAH / AJH144KELAH / AJH162KELAH



### Specifications

Rated capacity range		HP	8	10	12	14	16	18
Model name			AJH072KELAH	AJH090KELAH	AJH108KELAH	AJH126KELAH	AJH144KELAH	AJH162KELAH
Maximum connectable indoor units			1-20	1-25	1-30	1-36	1-40	1-42
Power source			3-phase, 400V~, 50Hz					
Capacity	Cooling	kW	22.4	28.0	33.5	40.0	45.0	50.0
	Nominal Heating	kW	22.4	28.0	33.5	40.0	45.0	50.0
	Max. Heating	kW	25.0	31.5	37.5	45.0	50.0	55.0
Input power	Cooling	kW	5.66	7.87	9.28	11.87	13.77	15.39
	Nominal Heating	kW	4.48	6.44	7.57	8.80	10.98	12.76
	Max. Heating	kW	5.46	7.92	9.95	10.67	13.23	14.95
EER	Cooling		3.96	3.56	3.61	3.37	3.27	3.25
COP	Nominal Heating	W/W	5.01	4.35	4.43	4.55	4.10	3.92
	Max. Heating	W/W	4.58	3.98	3.77	4.22	3.78	3.68
	SEER	Cooling	8.60	7.60	8.27	7.42	7.08	7.25
SCOP	Heating		4.92	4.62	4.82	4.56	4.52	4.51
$\eta_c$	Cooling	%	341.0	301.0	327.8	293.8	280.2	287.0
$\eta_h$	Heating	%	193.8	181.8	189.8	179.4	177.8	177.4
Airflow rate		m <sup>3</sup> /h	8,400 / 8,400	9,000 / 9,000	11,000 / 11,900	13,000 / 13,000	14,000 / 14,000	14,800 / 15,300
Sound pressure level/ Power level	Cooling	dB(A)	50 / 66	53 / 69	58 / 73	63 / 75	64 / 77	66 / 79
	Heating	dB(A)	52 / 66	56 / 70	62 / 75	65 / 76	67 / 78	69 / 82
Heat exchanger fin			Blue fin	Blue fin	Blue fin	Blue fin	Blue fin	Blue fin
Net Dimensions	Height	mm	1,428	1,428	1,428	1,638	1,638	1,638
	Width	mm	1,080	1,080	1,080	1,080	1,080	1,080
	Depth	mm	480	480	480	480	480	480
Weight		kg	169	177	178	213	213	213
Refrigerant	Type (Global Warming Potential)		R32 (675)	R32 (675)	R32 (675)	R32 (675)	R32 (675)	R32 (675)
	Charge (CO <sub>2</sub> eq-T)	kg	6.0 (4.05)	6.5 (4.388)	6.5 (4.388)	9.0 (6.075)	9.0 (6.075)	9.0 (6.075)
Connection pipe diameter	Liquid	mm	9.52	9.52	12.70	12.70	12.70	12.70
	Gas	mm	19.05	22.22	22.22	28.58	28.58	28.58
Total pipe length		m	400	400	400	400	400	
Max. height difference		m	50/40 (Outdoor unit: Upper/Lower)					
Operating Range	Cooling	°C	-15 to 46	-15 to 46	-15 to 46	-5 to 46	-5 to 46	-5 to 46
	Heating	°C	-20 to 21	-20 to 21	-20 to 21	-20 to 21	-20 to 21	-20 to 21

Note: Specifications are based on the following conditions.  
Cooling: Indoor temperature of 27°CDB/19°CWB, and outdoor temperature of 35°CDB/24°CWB.  
Heating: Indoor temperature of 20°CDB/(15°CWB), and outdoor temperature of 7°CDB/6°CWB.  
Pipe length: 11m (072/090), 15m (108/126/144/162); Height difference between outdoor unit and indoor unit: 0 m.  
The protective function may work when using it outside the operation range.

### Dimensions

(Unit: mm)

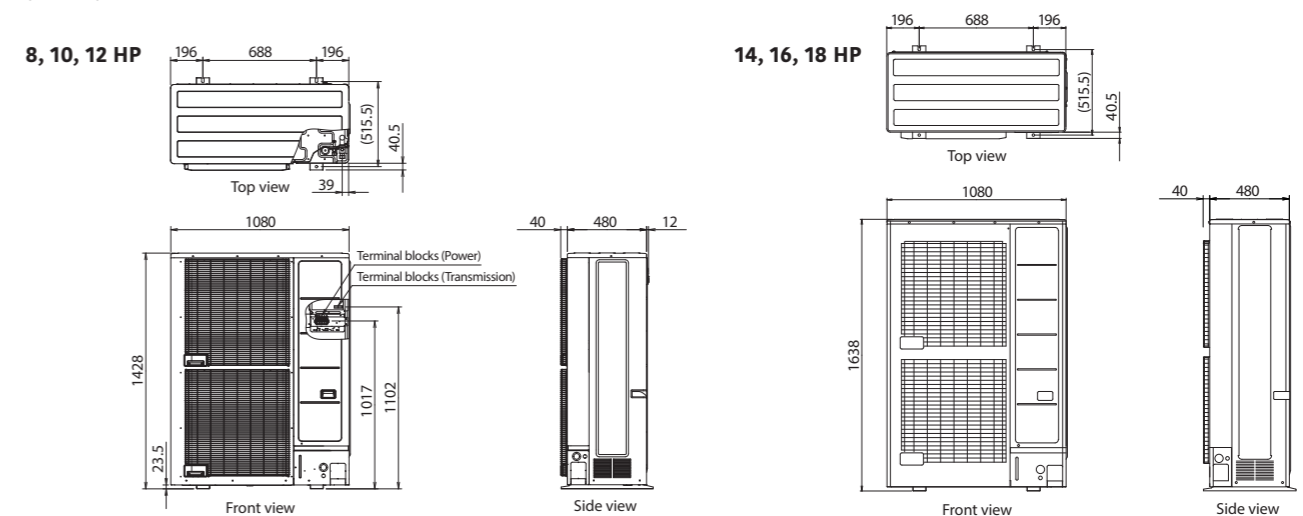



**Heat Pump / Heat Recovery**  
Modular type

**VRF VU-V**

**System configuration example**

- Suitable for air conditioning midsize and large buildings. Connecting each outdoor unit makes it possible to create a high-capacity system.
- Multiple indoor units are connected with separation tubes and headers.

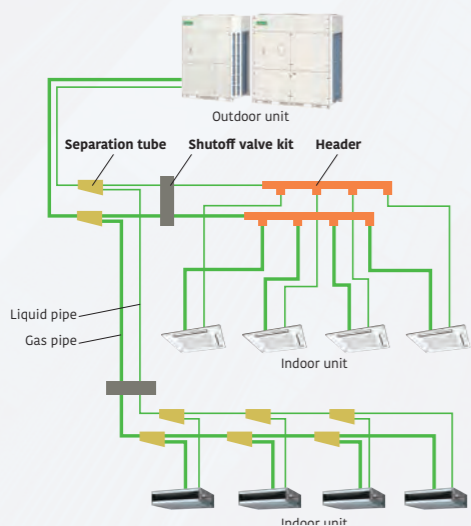

Single unit covers a wide range of projects



Single unit  
Max.  
**22 HP**  
61.5 kW  
47 Indoor units  
Combination  
Max. 44 HP

VU-V features many design improvements that yield higher performance and efficiency, wider operating ranges, greater design/installation flexibility, larger overall system capacities, and enhanced comfort.

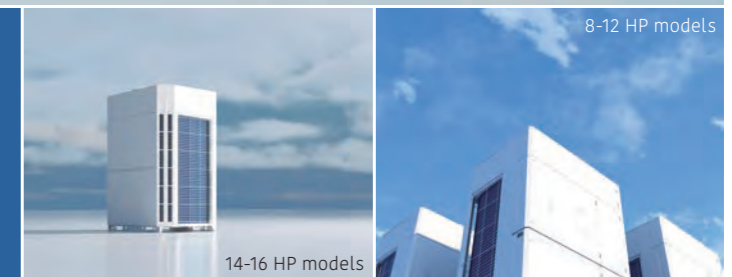

**Contributes to reduction of project costs**

Contributes to reducing project costs outdoor units can be installed individually, with options up to 22 HP. This reduces the number of outdoor units required for installation and the materials needed (piping, power lines, communication lines, racks, breakers, conduits, etc.). This product is expected to reduce project costs.

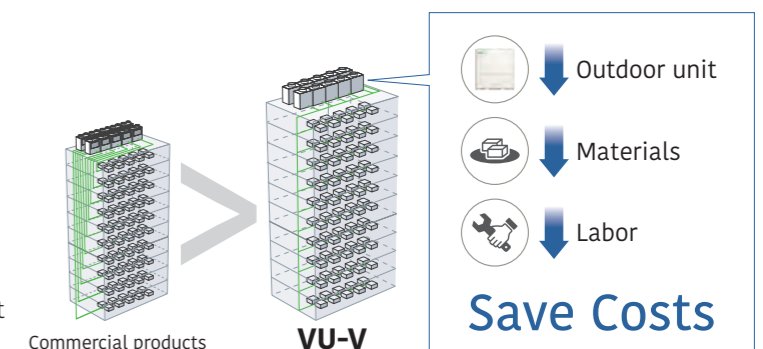

# High Energy Saving

## Intelligent refrigerant control

The Intelligent refrigerant control operates with suitable control corresponding to the heat load of the room and offers a more comfortable environment. The Intelligent refrigerant control can also provide increased energy savings.

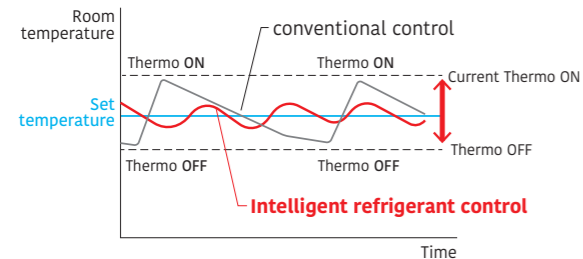

The thermostat is turned on and off less frequently than under conventional control to maintain the room temperature at the target temperature. Compared to conventional control, the compressor will run longer, thus saving energy.

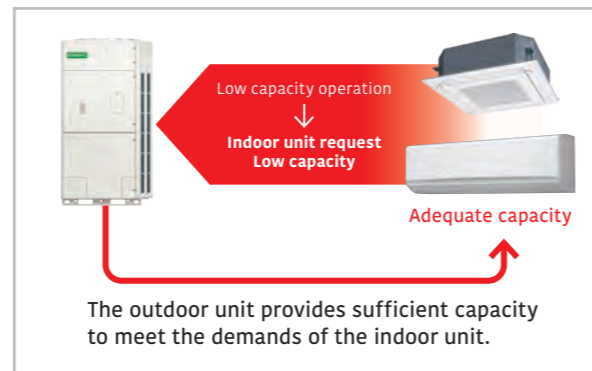

\* The improvements due to the control and the actual sine wave vary depending on the combination of the indoor unit and system operating conditions.

## Highly efficient operation

VU-V provides environmentally conscious, high-efficiency operation while ensuring comfort.

Cooling  $\eta_c$

ALL **250.0%** or above

Heating  $\eta_h$

ALL **151.5%** or above

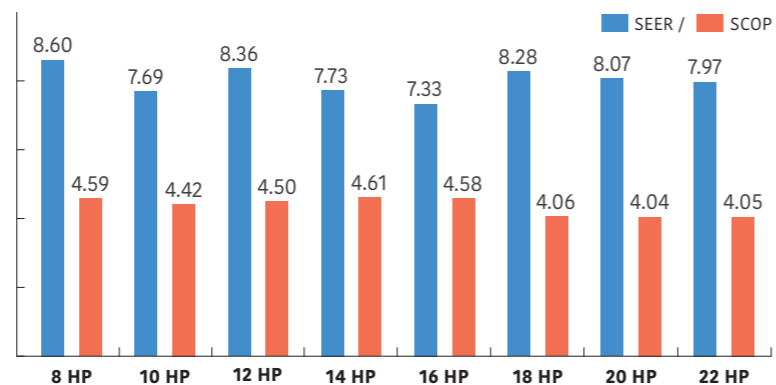

## Energy saving technology that boosts operation efficiency

### 18-22 HP models



**Powerful large propeller fan\***  
The fan uses CFD\* technology to achieve both high performance and low noise operation.  
\*CFD: Computational Fluid Dynamics



**3-phase DC fan motor\***  
The use of a DC fan motor with sophisticated driver control improves energy efficiency substantially. In addition, this motor operates quietly.



**Sine-wave DC inverter control\***  
High efficiency is realized by the adoption of reduced switching loss IPM.



**Subcooling heat exchanger**  
High heat exchange efficiency is achieved by using an internal projection-shape double-pipe construction.

\*: Same as 8-16 HP

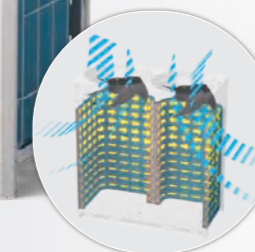

### Refrigerant flow control (18/20/22 HP)

Refrigerant flow is automatically adjusted within the heat exchanger depending on airflow balance.



### NEW Scroll compressor

The system uses a scroll compressor with a wide rotational-speed range (15-120 rps), combined with General's unique sensorless sine-wave control method. This method smoothly controls the input power supplied to the motor, improving both energy efficiency and noise performance.

### Variable refrigerant volume design of heat exchangers

If the outdoor air intake airflow of the left and right heat exchangers is different, the system automatically monitors the refrigerant status and adjusts the refrigerant flow rate of each heat exchanger to prevent loss of thermal efficiency.

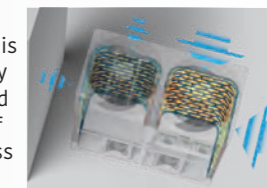

### 8-16 HP models

**4-face heat exchanger**  
The 4-face heat exchanger increases the effective surface area and significantly improves heat-exchanging efficiency.

### Front intake port (Corner cut air inlet structure)

In multiple outdoor unit installations, the unique front intake design improves airflow into the heat exchanger.

## Installation Flexibility



### Select system type according to the application

The same outdoor unit can be used for both heat pump and heat recovery applications.

#### Heat Pump System

We provide heat pumps that can reduce the initial cost of RB units and connecting pipes for properties that have the same air conditioning load for each area and are used in the same operation mode throughout the year.

#### Heat Recovery System

Heat recovery systems are proposed for office buildings where the air conditioning load varies between sun and shade in the middle of the year, and for restaurants/shops and hotels where different areas require different cooling/heating operations.

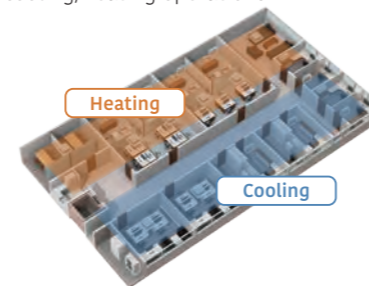
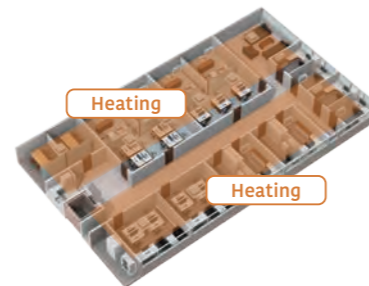

### Reducing outdoor unit installation space

A single outdoor unit can handle air conditioning up to 22 HP. This reduces reduce installation space and the number of outdoor units required.

#### Comparison at 22 HP

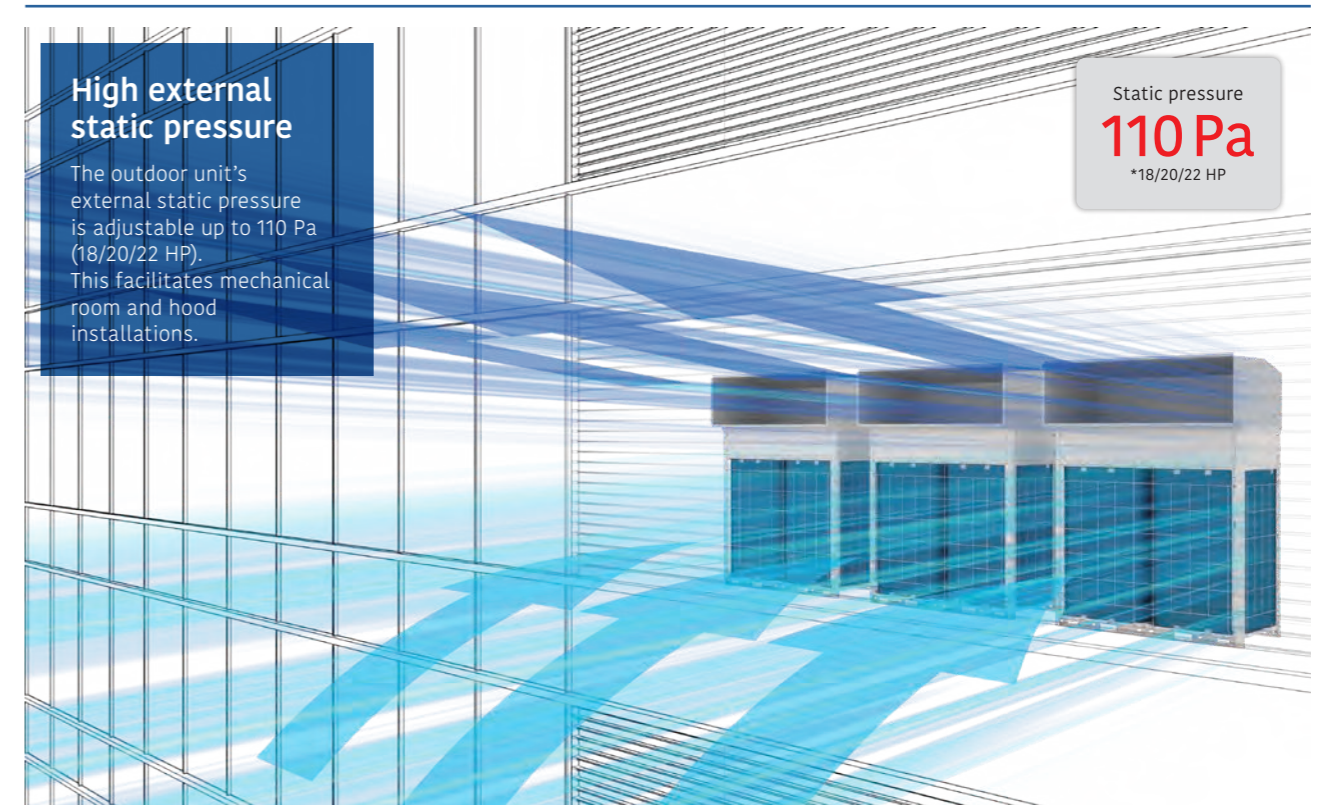
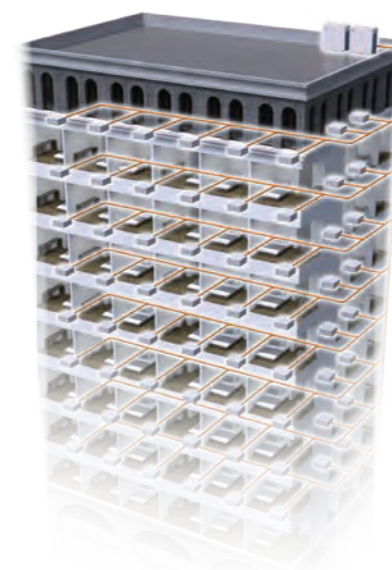

### Piping flexibility and safety measures

#### NEW RB Unit includes Shut off valve kit function

In addition to switching between cooling and heating modes, an electronic expansion valve function has been added to shut off the refrigerant. This eliminates the need to install a separate shutoff valve kit, reducing costs and improving installation efficiency.



NEW RB unit (1 Port)



NEW RB unit (4 Port)

No need to use Shut off valve kit for heat recovery use, provide simple installation

#### Enhanced disaster safety measures

It features a power backup function for use during power outages. Furthermore, to prevent refrigerant leakage during power failures, the shut-off valve closes when a power outage occurs.

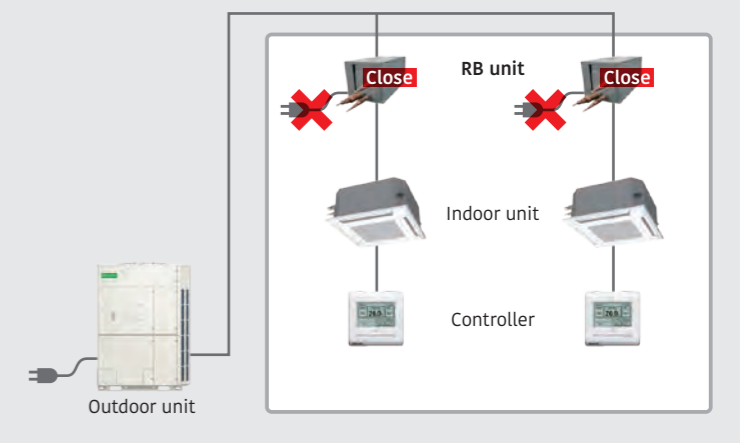

## Comfort

### Extended operating range for ambient temperature

Extended operable ambient temperature enables an offer to different regions with different temperature condition.

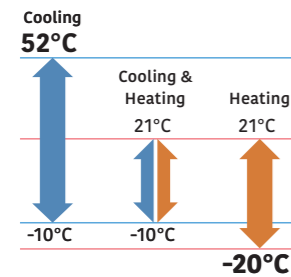

\*In the case of heat recovery.



### Rotation defrosting Heat Recovery type & additional type only

Rotation defrosting uses heat from other units instead of room heat, minimizing temperature drops and maintaining comfort during defrosting.

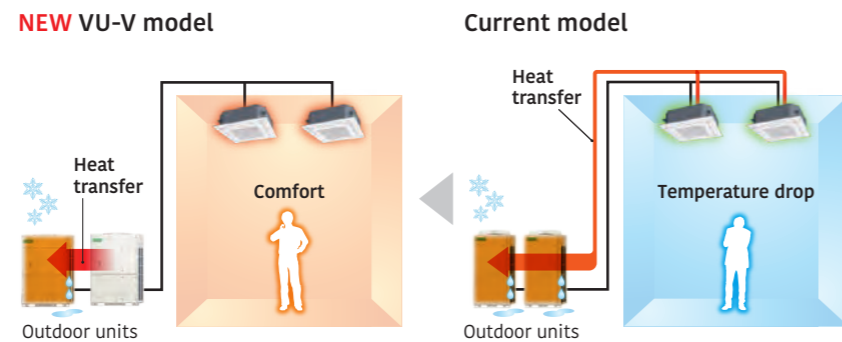

### Environmentally conscious with low-noise mode

5-steps low-noise modes are available. This allows for detailed noise control in various external environments.

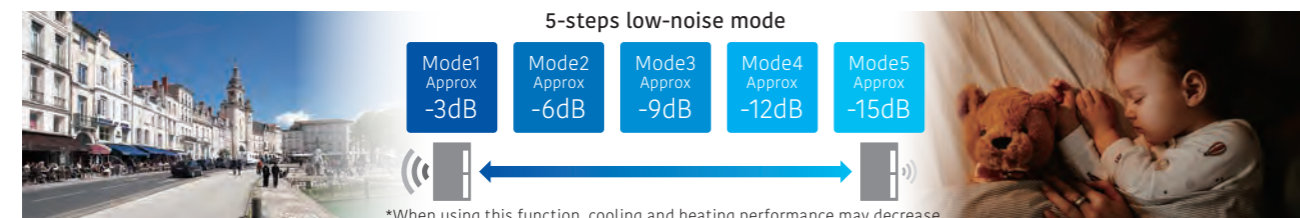

\*When using this function, cooling and heating performance may decrease.

## Easy Support

### Safety measures in case of refrigerant leak

Indoor units compatible with R32 refrigerant are equipped with a refrigerant leak detector. (Some indoor units require optional purchase.) Depending on the conditions of the room where the indoor unit is installed, countermeasures can be implemented using detection equipment.\* When activated, the refrigerant leak detector triggers the "Shut off valve kit" and "Wired Remote Controller" to operate simultaneously. This notifies the user or administrator of a refrigerant leak while simultaneously stopping refrigerant circulation.

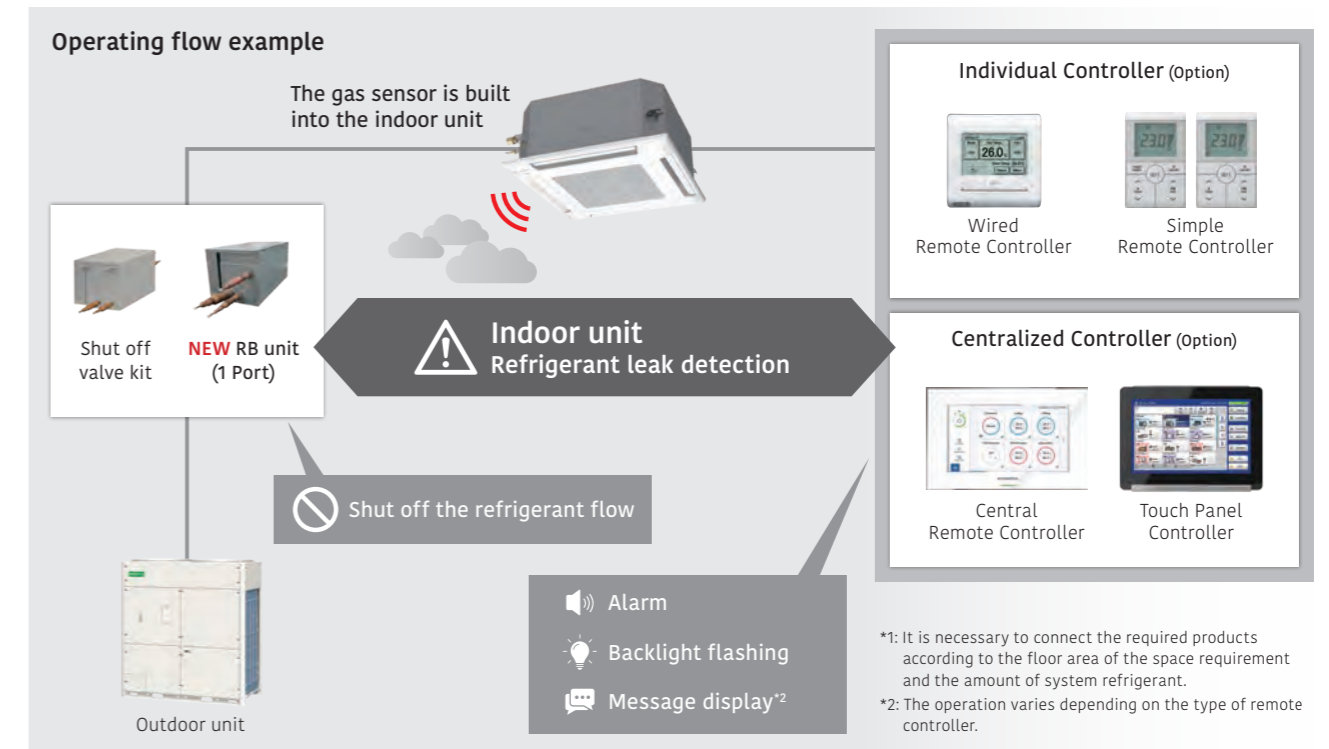

\*1: It is necessary to connect the required products according to the floor area of the space requirement and the amount of system refrigerant.  
\*2: The operation varies depending on the type of remote controller.





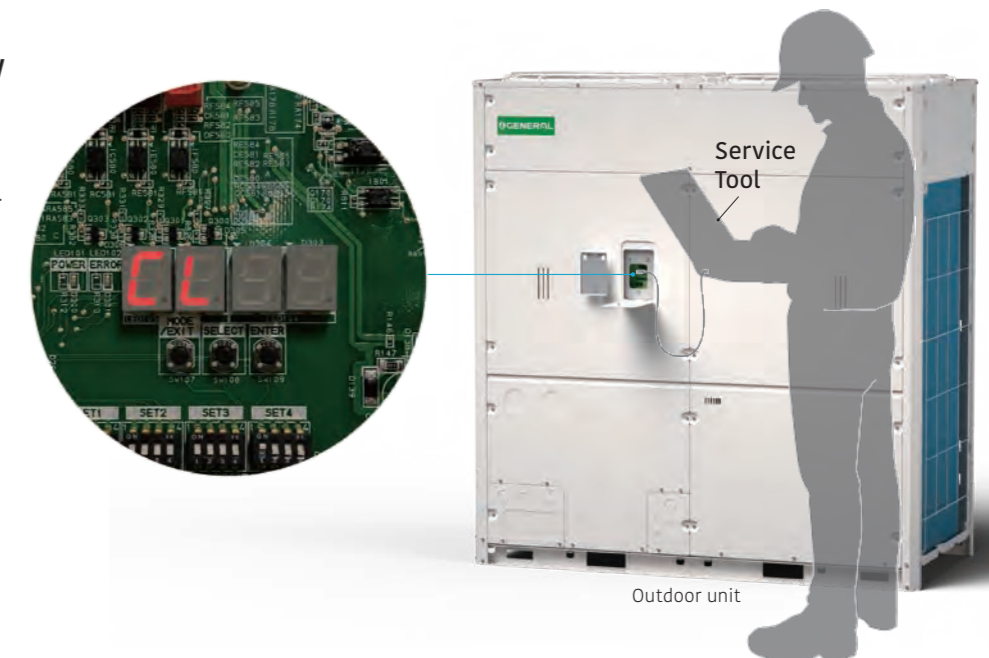













### Service and maintenance window

The service window provides easy access to all multifunction displays and buttons without removing any main front panels. It is also convenient when connecting service tools.







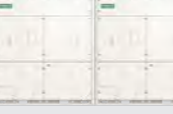

Outdoor units lineup • Combinations other than those listed below are not recommended.

Space saving combination

22.4 kW (8 HP)  AJH072HALAH UNIT:AJH072HALAH	28.0 kW (10 HP)  AJH090HALAH UNIT:AJH090HALAH	33.5 kW (12 HP)  AJH108HALAH UNIT:AJH108HALAH	40.0 kW (14 HP)  AJH126HALAH UNIT:AJH126HALAH	45.0 kW (16 HP)  AJH144HALAH UNIT:AJH144HALAH
50.0 kW (18 HP)  AJH162HALAH UNIT:AJH162HALAH	56.0 kW (20 HP)  AJH180HALAH UNIT:AJH180HALAH	61.5 kW (22 HP)  AJH198HALAH UNIT:AJH198HALAH	67.0 kW (24 HP)  AJH216HALAH UNIT:AJH108/108HALAH	73.0 kW (26 HP)  AJH234HALAH UNIT:AJH144/090HALAH
78.5 kW (28 HP)  AJH252HALAH UNIT:AJH144/108HALAH	85.0 kW (30 HP)  AJH270HALAH UNIT:AJH144/126HALAH	90.0 kW (32 HP)  AJH288HALAH UNIT:AJH144/144HALAH	96.0 kW (34 HP)  AJH306HALAH UNIT:AJH180/126HALAH	101.5 kW (36 HP)  AJH324HALAH UNIT:AJH198/126HALAH
106.5 kW (38 HP)  AJH342HALAH UNIT:AJH198/144HALAH	111.5 kW (40 HP)  AJH360HALAH UNIT:AJH198/162HALAH	117.5 kW (42 HP)  AJH378HALAH UNIT:AJH198/180HALAH	123.0 kW (44HP)  AJH396HALAH UNIT:AJH198/198HALAH	

Energy efficiency combination

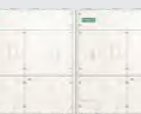
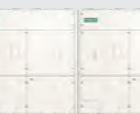
44.8 kW (16 HP)  AJH144HALAHH UNIT:AJH072/072HALAHH	50.4 kW (18 HP)  AJH162HALAHH UNIT:AJH090/072HALAHH	56.0 kW (20 HP)  AJH180HALAHH UNIT:AJH090/090HALAHH	61.5 kW (22 HP)  AJH198HALAHH UNIT:AJH108/090HALAHH	67.4 kW (24 HP)  AJH216HALAHH UNIT:AJH144/072HALAHH
80.0 kW (28 HP)  AJH252HALAHH UNIT:AJH126/126HALAHH	90.0 kW (32 HP)  AJH288HALAHH UNIT:AJH162/126HALAHH	100.0 kW (36 HP)  AJH324HALAHH UNIT:AJH162/162HALAHH	106.0 kW (38 HP)  AJH342HALAHH UNIT:AJH180/162HALAHH	



Dimensions

(Unit: mm)

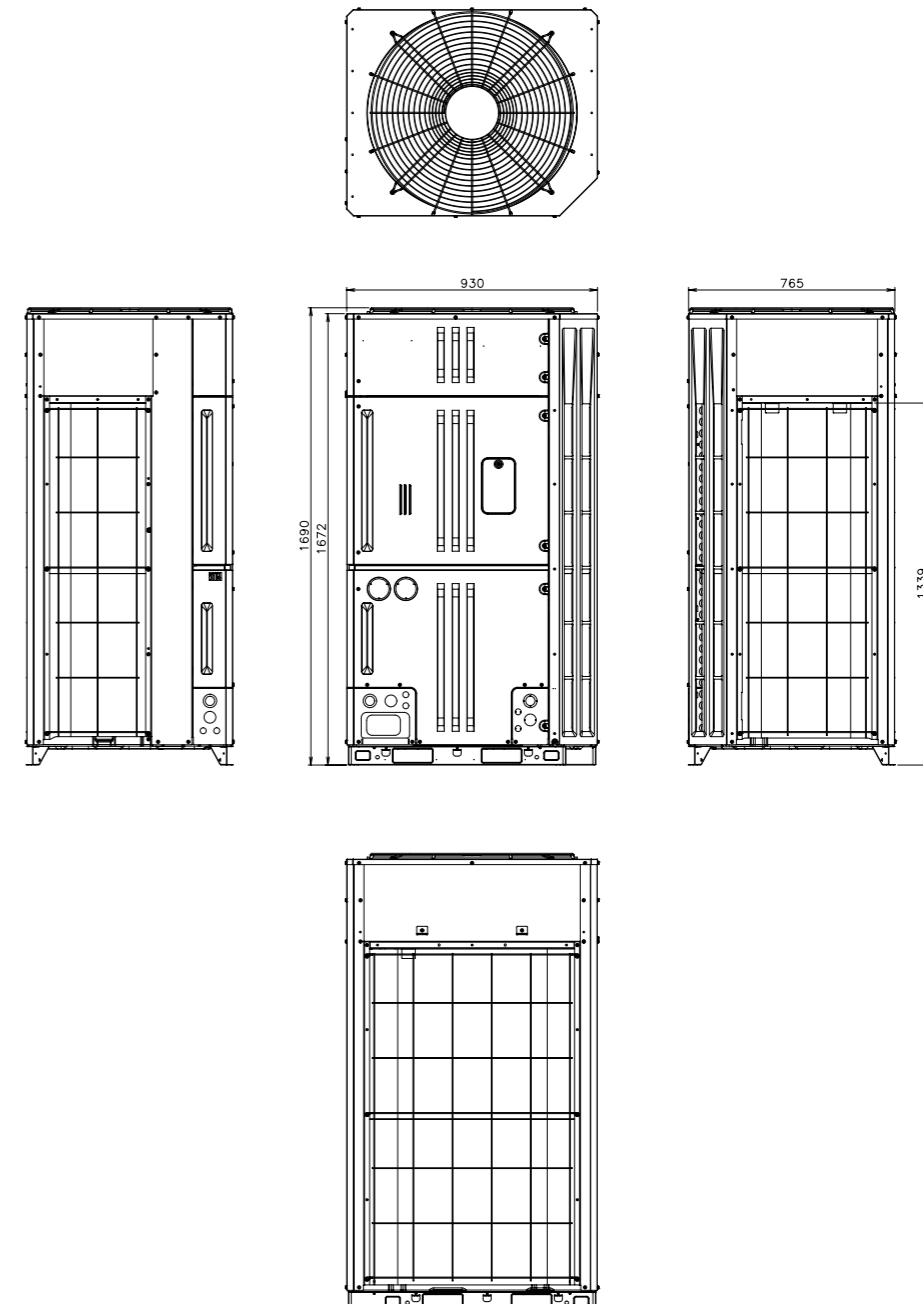



Dimensions

(Unit: mm)

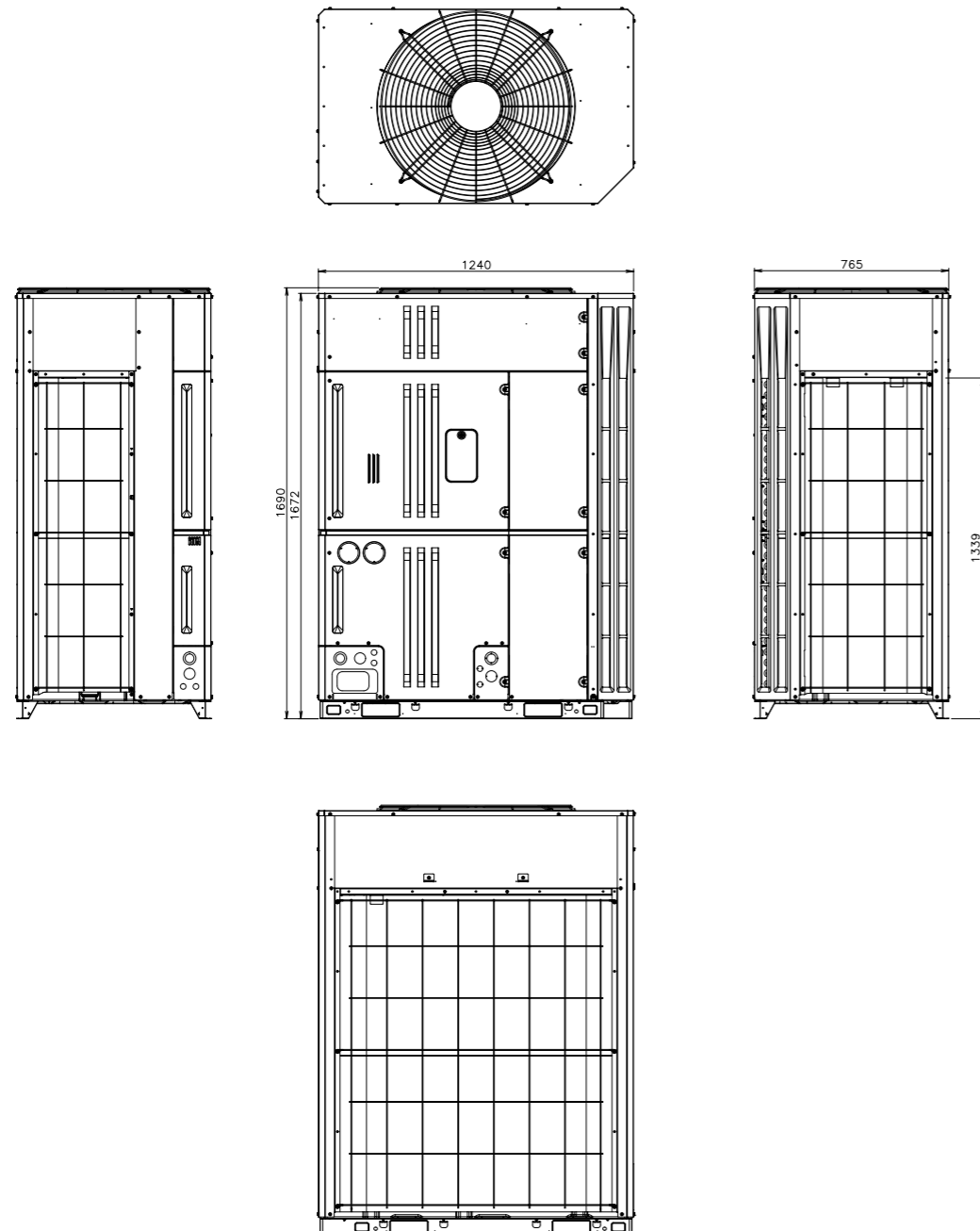

Dimensions

(Unit: mm)

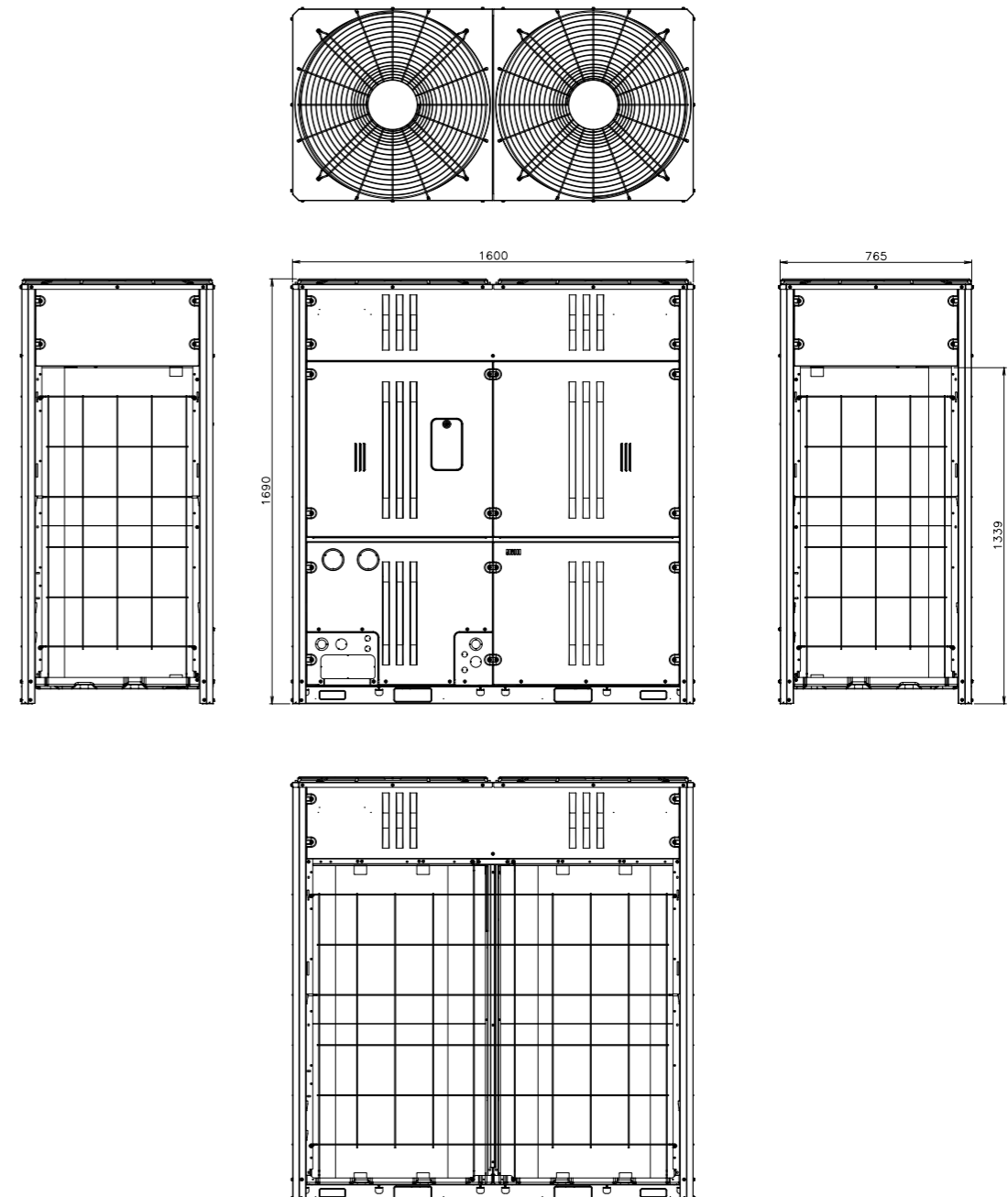



Outdoor unit specifications (Heat Pump)

Space saving combination

Rated Capacity range			HP	8	10	12	14	16	18	20	22	24	26	28	30	32	34	36	38	40	42	44		
Model Name				AJH072HALAH	AJH090HALAH	AJH108HALAH	AJH126HALAH	AJH144HALAH	AJH162HALAH	AJH180HALAH	AJH198HALAH	AJH216HALAH	AJH234HALAH	AJH252HALAH	AJH270HALAH	AJH288HALAH	AJH306HALAH	AJH324HALAH	AJH342HALAH	AJH360HALAH	AJH378HALAH	AJH396HALAH		
Unit 1				AJH072HALAH	AJH090HALAH	AJH108HALAH	AJH126HALAH	AJH144HALAH	AJH162HALAH	AJH180HALAH	AJH198HALAH	AJH216HALAH	AJH234HALAH	AJH252HALAH	AJH270HALAH	AJH288HALAH	AJH306HALAH	AJH324HALAH	AJH342HALAH	AJH360HALAH	AJH378HALAH	AJH396HALAH		
Unit 2				AJH072HALAH	AJH090HALAH	AJH108HALAH	AJH126HALAH	AJH144HALAH	AJH162HALAH	AJH180HALAH	AJH198HALAH	AJH216HALAH	AJH234HALAH	AJH252HALAH	AJH270HALAH	AJH288HALAH	AJH306HALAH	AJH324HALAH	AJH342HALAH	AJH360HALAH	AJH378HALAH	AJH396HALAH		
Maximum connectable indoor units*1				17	21	26	30	34	39	43	47	52	55	60	64	64	64	64	64	64	64	64		
Connectable capacity range of indoor units			min-max	kW	11.2-33.6	14.0-42.0	16.8-50.2	20.0-60.0	22.5-67.5	25.0-75.0	28.0-84.0	30.8-92.2	33.5-100.5	36.5-109.5	39.3-117.7	42.5-127.5	45.0-135.0	48.0-144.0	50.8-152.2	53.3-159.7	55.8-167.2	58.8-176.2	61.5-184.5	
Power source				3-phase, 4-wire, 400 V, 50Hz											3-phase, 4-wire, 400 V, 50Hz									
Capacity	Cooling	kW		22.4	28.0	33.5	40.0	45.0	50.0	56.0	61.5	67.0	73.0	78.5	85.0	90.0	96.0	101.5	106.5	111.5	117.5	123.0		
			Nominal Heating	22.4	28.0	33.5	40.0	42.0	50.0	56.0	61.5	67.0	70.0	75.5	82.0	84.0	96.0	101.5	103.5	111.5	117.5	123.0		
			Max. Heating	25.0	31.5	37.5	45.0	48.0	56.5	63.0	69.0	75.0	79.0	85.5	93.0	96.0	108.0	114.0	117.0	125.5	132.0	138.0		
Input power	Cooling	kW		5.58	7.50	9.43	11.76	14.06	12.69	15.13	17.62	18.86	21.56	23.50	25.82	28.12	26.89	29.38	31.68	30.31	32.75	35.24		
			Nominal Heating	4.50	6.43	7.70	9.52	9.95	12.19	14.10	15.56	15.40	16.38	17.65	19.47	19.90	23.62	25.08	25.51	27.75	29.66	31.12		
			Max. Heating	5.58	8.20	9.48	12.07	12.43	13.54	17.87	20.36	18.96	20.63	21.91	24.50	24.86	29.94	32.43	32.79	33.90	38.23	40.72		
EER	Cooling	W/W		4.01	3.73	3.55	3.40	3.20	3.94	3.70	3.49	3.55	3.38	3.34	3.29	3.20	3.57	3.45	3.36	3.67	3.58	3.49		
			Nominal Heating	4.97	4.35	4.35	4.23	4.10	4.23	3.95	4.27	4.35	4.27	4.27	4.27	4.22	4.06	4.04	4.05	4.01	3.96	3.95		
			Max. Heating	4.48	3.84	3.95	3.72	3.86	4.17	3.52	3.38	5.30	5.30	5.37	5.20	5.43	4.81	4.69	4.87	4.93	4.60	4.53		
SEER	Cooling		8.60	7.69	8.36	7.73	7.33	8.28	8.07	7.97	8.36	7.51	7.84	7.53	7.33	7.90	7.85	7.65	8.12	8.02	7.97			
	Heating		4.59	4.42	4.50	4.61	4.58	4.06	4.04	4.05	4.50	4.50	4.54	4.59	4.58	4.32	4.33	4.31	4.05	4.04	4.05			
SCOP	Cooling		341.4	304.6	331.4	306.2	290.2	328.2	319.8	315.8	331.4	297.4	310.8	298.2	290.2	313.0	311.0	303.0	322.0	317.8	315.8			
	Heating		180.6	173.8	177.0	181.4	180.2	159.4	158.6	159.0	177.0	177.0	178.6	180.8	180.2	170.0	170.2	169.6	159.2	158.8	159.0			
Air flow rate	High	m³/h	11,100	11,100	11,100	13,200	13,200	20,000	22,200	22,200	11,100×2	13,200+11,100	13,200+11,100	13,200×2	13,200×2	22,200+13,200	22,200+13,200	22,200+13,200	22,200+20,000	22,200×2	22,200×2			
	Sound pressure level*2 / Power level	dB(A)	57/77	60/80	61/81	61/81	61/81	61/81	65/85	65/85	64/84	64/84	64/84	66/86	66/86	66/86	66/86	66/86	66/86	66/86	68/88	68/88		
Max. External static pressure	Cooling	Pa	80	80	80	80	80	110	110	110	80	80	80	80	80	80	80	110	110	110	110			
	Heating	kW	6.10	6.10	6.10	7.90	7.90	6.10 × 2	6.10 × 2	6.10 × 2	6.10 × 2	7.90 × 6.10	7.90 × 6.10	7.90 × 6.10	7.90 × 2	7.90 × 7.90	6.10 × 2 + 7.90	6.10 × 2 + 7.90	6.10 × 2 + 7.90	6.10 × 2 + 6.10 × 2	6.10 × 2 + 6.10 × 2	6.10 × 2 × 2		
Heat exchanger fin				Corrugate (Aluminum)	Corrugate (Aluminum)	Corrugate (Aluminum)	Corrugate (Aluminum)	Corrugate (Aluminum)	Corrugate (Aluminum)	Corrugate (Aluminum)	Corrugate (Aluminum)	Corrugate (Aluminum)	Corrugate (Aluminum)	Corrugate (Aluminum)	Corrugate (Aluminum)	Corrugate (Aluminum)	Corrugate (Aluminum)	Corrugate (Aluminum)	Corrugate (Aluminum)	Corrugate (Aluminum)	Corrugate (Aluminum)	Corrugate (Aluminum)		
Net Dimensions	Height	mm		1,690	1,690	1,690	1,690	1,690	1,690	1,690	1,690	1,690	1,690	1,690	1,690	1,690	1,690	1,690	1,690	1,690	1,690	1,690		
	Width		930	930	930	1,240	1,240	1,600	1,600	1,600	930×2	1,240+930	1,240+930	1,240×2	1,240×2	1,600+1,240	1,600+1,240	1,600+1,240	1,600×2	1,600×2	1,600×2			
	Depth		765	765	765	765	765	765	765	765	765	765	765	765	765	765	765	765	765	765	765	765		
Weight			kg	251	251	251	278	278	414	414	414	251×2	278+251	278+251	278×2	278×2	414+278	414+278	414+278	414×2	414×2	414 × 2		
Refrigerant	Type (Global Warming Potential)		R32 (675)	R32 (675)	R32 (675)	R32 (675)	R32 (675)	R32 (675)	R32 (675)	R32 (675)	R32 (675)	R32 (675)	R32 (675)	R32 (675)	R32 (675)	R32 (675)	R32 (675)	R32 (675)	R32 (675)	R32 (675)	R32 (675)	R32 (675)		
	Charge	kg (CO2eq-T)	9.8 (6.615)	9.8 (6.615)	9.8 (6.615)	11.8 (7.965)	11.8 (7.965)	11.8 (7.965)	11.8 (7.965)	11.8 (7.965)	11.8 (7.965)	9.8×2 (6.615×2)	11.8+9.8 (7.965+6.615)	11.8+9.8 (7.965+6.615)	11.8×2 (7.965×2)	11.8×2 (7.965×2)	11.8×2 (7.965×2)	11.8×2 (7.965×2)	11.8×2 (7.965×2)	11.8×2 (7.965×2)	11.8×2 (7.965×2)	11.8×2 (7.965×2)	11.8×2 (7.965×2)	
Connection pipe diameter	Liquid	mm		9.52	9.52	12.70	12.70	12.70	12.70	12.70	12.70	12.70	15.88	15.88	15.88	15.88	15.88	15.88	15.88	15.88	15.88	15.88		
	Gas		19.05	19.05	22.22	22.22	22.22	22.22	28.58	28.58	28.58	28.58	28.58	28.58	34.92	34.92	34.92	34.92	34.92	34.92	34.92	34.92		
Operating Range	Cooling	°CDB		-15 to 52	-15 to 52	-15 to 52	-15 to 52	-15 to 52	-15 to 52	-15 to 52	-15 to 52	-15 to 52	-15 to 52	-15 to 52	-15 to 52	-15 to 52	-15 to 52	-15 to 52	-15 to 52	-15 to 52	-15 to 52	-15 to 52		
	Heating		-20 to 21	-20 to 21	-20 to 21	-20 to 21	-20 to 21	-20 to 21	-20 to 21	-20 to 21	-20 to 21	-20 to 21	-20 to 21	-20 to 21	-20 to 21	-20 to 21	-20 to 21	-20 to 21	-20 to 21	-20 to 21	-20 to 21	-20 to 21	-20 to 21	

Energy Efficiency Combination

Rated Capacity range			HP	16	18	20	22	24	28	32	36	38			
Model Name				AJH144HALAHH	AJH162HALAHH	AJH180HALAHH	AJH198HALAHH	AJH216HALAHH	AJH252HALAHH	AJH288HALAHH	AJH324HALAHH	AJH342HALAHH			
Unit 1				AJH072HALAH	AJH090HALAH	AJH090HALAH	AJH108HALAH	AJH144HALAH	AJH126HALAH	AJH126HALAH	AJH162HALAH	AJH180HALAH			
Unit 2				AJH072HALAH	AJH072HALAH	AJH090HALAH	AJH090HALAH	AJH126HALAH	AJH126HALAH	AJH126HALAH	AJH126HALAH	AJH162HALAH			
Maximum connectable indoor units*1				34	38	42	47	51	60	64	64	64			
Connectable capacity range of indoor units			min-max	kW	22.4 - 67.2	25.2 - 75.6	28.0 - 84.0	30.8 - 92.3	33.7 - 101.1	40.0 - 120.0	45.0 - 135.0	50.0 - 150.0	53.0 - 159.0		
Power source				3-phase, 4-wire, 400 V, 52Hz						3-phase, 4-wire, 400 V, 58Hz					
Capacity	Cooling	kW		44.8	50.4	56.0	61.5	67.4	80.0	90.0	100.0	106.0			
			Nominal Heating	44.8	50.4	56.0	61.5	64.4	80.0	80.0	90.0	100.0	106.0		
			Max. Heating	50.0	56.5	63.0	69.0	73.0	90.0	90.0	101.5	113.0	119.5		
Input power	Cooling	kW		11.16	13.08	15.00	16.94	19.64	23.52	24.45	25.38	27.82			
			Nominal Heating	9.00	10.93	12.86	14.13	14.45	19.04	19.04	21.71	24.38	26.29		
			Max. Heating	11.16	13.78	16.40	17.68	18.01	24.14	25.61	27.08	31.41	31.41		
EER	Cooling	W/W		4.01	3.85	3.73	3.63	3.43	3.40	3.68	3.94	3.81			
			Nominal Heating	4.97	4.61	4.35	4.35	4.66	4.20	4.14	4.10	4.03			
			Max. Heating	4.48	4.10	3.84	3.90	4.05	3.72	3.96	4.17	3.80			
SEER	Cooling		8.60	8.14	7.69	8.02	7.96	7.73	8.00	8.28	7.98				
	Heating		4.59	4.50	4.42	4.46	4.59	4.61	4.34	4.06	4.24				
SCOP	Cooling		341.0	322.8	304.6	318.0	315.6	306.2	317.2	328.2	316.4				
	Heating		180.6	177.2	173.8	175.4	180.4	181.4	170.4	159.4	166.6				
Air flow rate	High	m³/h	11,100×2	11,100×2	11,100×2	11,100×2	13,200+11,100	13,200×2	20,000+13,200	20,000×2	22,200+20,000				
	Sound pressure level*2 / Power level	dB(A)	60/80	62/82	63/83	64/84	64/84	64/84	64/84	66/86	66/86	66/86			
Max. External static pressure	Cooling	Pa	80	80	80	80	80	80	80	80	110	110			
	Heating	kW	6.10×2	6.10×2	6.10×2	6.10×2	6.10×2	7.90+6.10	7.90×2	6.10 x 2+7.90	6.10 x 2×2	6.10 x 2×2			
Heat exchanger fin				Corrugate (Aluminum)	Corrugate (Aluminum)	Corrugate (Aluminum)	Corrugate (Aluminum)	Corrugate (Aluminum)	Corrugate (Aluminum)	Corrugate (Aluminum)	Corrugate (Aluminum)	Corrugate (Aluminum)			
Net Dimensions	Height	mm		1,690	1,690	1,690	1,690	1,690	1,690	1,690	1,690	1,690			
	Width		930×2	930×2	930×2	930×2	930×2	1,240+930	1,240×2	1,600+1,240	1,600×2	1,600×2			
	Depth		765	765	765	765	765	765	765	765	765	765			
Weight			kg	251×2	251×2	251×2	251×2	278+251	278×2	414+278	414×2	414×2			
Refrigerant	Type (Global Warming Potential)		R32 (675)	R32 (675)	R32 (675)	R32 (675)	R32 (675)	R32 (675)	R32 (675)	R32 (675)	R32 (675)	R32 (675)			
	Charge	kg (CO2eq-T)	9.8×2 (6.615×2)	9.8×2 (6.615×2)	9.8×2 (6.615×2)	9.8×2 (6.615×2)	9.8×2 (6.615×2)	11.8+9.8 (7.965+6.615)	11.8×2 (7.965×2)	11.8×2 (7.965×2)	11.8×2 (7.965×2)	11.8×2 (7.965×2)			
Connection pipe diameter	Liquid	mm		12.70	12.70	12.70	12.70	12.70	15.88	15.88	15.88	15.88			
	Gas		22.22	22.22	28.58	28.58	28.58	28.58	34.92	34.92	34.92	34.92			
Operating Range	Cooling	°CDB		-5 to											



# VRF R32 INDOOR UNITS

5 types and 121 models available to meet the requirements of any building design.

Indoor units for the VRF Systems are compact, highly efficient, quiet, and user-friendly. General offers a variety of types and capacities for its indoor units that are easy to install and maintain. In addition, a variety of optional parts are available to provide an even more desirable air conditioning experience to users.

V-050 VRF Indoor Unit Lineup for J-VS, J-VL, VU-V

## Cassette

V-056 Compact 4-way flow

**Cassette** - Built in gas sensor

V-058 Compact 4-way flow

V-060 Circular Flow - Slim

V-062 Circular Flow - Large

V-064 1-way Flow Cassette

**Duct** - Built in gas sensor

V-066 Low Static Pressure Mini Duct

V-068 Low Static Pressure Slim Duct

V-070 Medium Static Pressure

V-072 High Static Pressure Duct

**Floor, Ceiling** - Built in gas sensor

V-076 Compact floor (EEV Internal/external)

V-078 Ceiling

**Wall-Mounted** - Built in gas sensor

V-080 Wall-Mounted (EEV Internal/external)

V-082 Wall-Mounted

**Wall-Mounted**

V-084 Wall-Mounted (EEV Internal/external)



# VRF Indoor Unit Lineup for J-VS J-VL VU-V

Capacity range (kW)			1.1	1.7	2.2	2.8	3.6	4.0	4.5	5.6	7.1	9.0	10.0	11.2	12.5	14.0	18.0	22.4	25.0	28.0		
Class			4	5	7	9	12	14	14	18	24	30	34	36	45	54	60	72	90	96		
Cassette	Compact 4-way flow	Standard*1		AUXB 004 HLAH	AUXB 005 HLAH	AUXB 007 HLAH	AUXB 009 HLAH	AUXB 012 HLAH		AUXB 014 HLAH	AUXB 018 HLAH											
		Standard Built in gas sensor		NEW	AUXB 004 HLBH	AUXB 005 HLBH	AUXB 007 HLBH	AUXB 009 HLBH	AUXB 012 HLBH		AUXB 014 HLBH	AUXB 018 HLBH										
		High Efficiency*1*2					AUXN 009 HLAH	AUXN 012 HLAH		AUXN 014 HLAH												
	Circular Flow	Slim Built in gas sensor		NEW			AUXM 009 HLBH	AUXM 012 HLBH		AUXM 014 HLBH	AUXM 018 HLBH	AUXM 024 HLBH	AUXM 030 HLBH									
		High Efficiency*2 Built in gas sensor		NEW							AUXN 018 HLBH											
		Large Built in gas sensor		NEW							AUXK 018 HLBH	AUXK 024 HLBH	AUXK 030 HLBH	AUXK 034 HLBH	AUXK 036 HLBH	AUXK 045 HLBH	AUXK 054 HLBH					
	1-way Flow	Built in gas sensor		NEW	AUXV 004 HLBH	AUXV 005 HLBH	AUXV 007 HLBH	AUXV 009 HLBH	AUXV 012 HLBH		AUXV 014 HLBH	AUXV 018 HLBH	AUXV 024 HLBH									
Duct	Low Static Pressure	Mini Duct Built in gas sensor		NEW	ARXK 004 HLBH	ARXK 005 HLBH	ARXK 007 HLBH	ARXK 009 HLBH	ARXK 012 HLBH		ARXK 014 HLBH	ARXK 018 HLBH	ARXK 024 HLBH									
		Slim Duct Built in gas sensor		NEW	ARXD 004 HLBH	ARXD 005 HLBH	ARXD 007 HLBH	ARXD 009 HLBH	ARXD 012 HLBH		ARXD 014 HLBH	ARXD 018 HLBH	ARXD 024 HLBH									
		High Efficiency*1*2						ARXP 009 HLAH	ARXP 012 HLAH		ARXP 014 HLAH											
	Medium Static Pressure	Standard Built in gas sensor		NEW			ARXL 007 HTBH	ARXL 009 HTBH	ARXL 012 HTBH		ARXL 014 HTBH	ARXL 018 HTBH	ARXL 024 HTBH	ARXL 030 HTBH		ARXL 036 HTBH	ARXL 045 HTBH					
		High Efficiency*2 Built in gas sensor		NEW							ARXP 018 HTBH		ARXP 030 HTBH									
	High Static Pressure*3	Built in gas sensor		NEW											ARXC 036 HTBH	ARXC 045 HTBH		ARXC 060 HTBH				
		Built in gas sensor		NEW															ARXC 072 HTBH	ARXC 090 HTBH	ARXC 096 HTBH	
Floor	EEV Internal Built in gas sensor		NEW			AGHA 007 HCBH	AGHA 009 HCBH	AGHA 012 HCBH	AGHA 014 HCBH													
	EEV External Built in gas sensor		NEW			AGHE 007 HCBH	AGHE 009 HCBH	AGHE 012 HCBH	AGHE 014 HCBH													
Ceiling	Built in gas sensor		NEW					ABHA 012 HTBH		ABHA 014 HTBH	ABHA 018 HTBH	ABHA 024 HTBH	ABHA 030 HTBH	ABHA 036 HTBH	ABHA 045 HTBH	ABHA 054 HTBH						
Wall-Mounted	Compact Wall-mounted EEV Internal Built in gas sensor		NEW	ASHA 004 HTBH	ASHA 005 HTBH	ASHA 007 HTBH	ASHA 009 HTBH	ASHA 012 HTBH	ASHA 014 HTBH		ASHA 018 HTBH											
	Compact Wall-mounted EEV External Built in gas sensor		NEW	ASHE 004 HTBH	ASHE 005 HTBH	ASHE 007 HTBH	ASHE 009 HTBH	ASHE 012 HTBH	ASHE 014 HTBH		ASHE 018 HTBH											
	Large Wall-mounted Built in gas sensor		NEW								ASHB 018 HTBH	ASHB 024 HTBH	ASHB 030 HTBH	ASHB 034 HTBH								
	EEV Internal*1			ASHA 004 HCAH	ASHA 005 HCAH	ASHA 007 HCAH	ASHA 009 HCAH	ASHA 012 HCAH	ASHA 014 HCAH													
	EEV External*1			ASHE 004 HCAH	ASHE 005 HCAH	ASHE 007 HCAH	ASHE 009 HCAH	ASHE 012 HCAH	ASHE 014 HCAH													

\*1:AUXB\*\*\*HLAH and ASHA\*\*\*HCAH, ASHE\*\*\*HCAH, ARXP\*\*\*HLAH, AUXN\*\*\*HLAH are only connectable to J-VS and J-VL. \*2:Production by order  
\*3:ARXC060/072/090/096HTBH cannot be connected to the J-VS and J-VL series.

# Cassette

Compact 4-way flow

\*This product does not include a gas sensor.



## Compact and Stylish Panel

The compact and stylish panel fits nicely into a grid type ceiling. The linear design is a perfect fit into a grid of 620 mm x 620 mm in the ceiling.

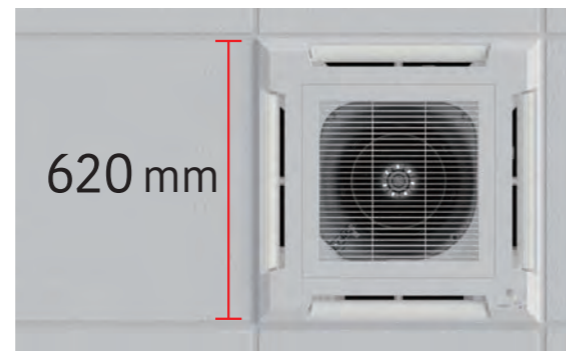

## Easy Maintenance

You can access the unit for maintenance just by removing a ceiling panel right next to the grille. As no inspection hole needs to be cut through the ceiling, no additional construction cost is incurred.



The air inlet grille can be installed to open in any direction for easy maintenance.



## Flexible Installation

The unit fits nicely into the decor of a grid type ceiling and can be installed near a lighting or a ventilation opening.



## High Ceiling mode

The cassette can be installed up to a height of 3.0 m. (012/014/018).

Model code	Maximum height from floor to ceiling (m)	
	Standard mode	High ceiling mode
004	2.7	-
005	2.7	-
007	2.7	-
009	2.7	-
012	2.7	3.0
014	2.7	3.0
018	2.7	3.0

**Model: AUXB004HLAH / AUXB005HLAH / AUXB007HLAH  
AUXB009HLAH / AUXB012HLAH / AUXB014HLAH  
AUXB018HLAH**

**AUXN009HLAH / AUXN012HLAH / AUXN014HLAH**  
\* Production by order



## Specifications

Model name	AUXB 004HLAH	AUXB 005HLAH	AUXB 007HLAH	AUXB 009HLAH	AUXB 012HLAH	AUXB 014HLAH	AUXB 018HLAH	AUXN 009HLAH	AUXN 012HLAH	AUXN 014HLAH	
Power source	Single phase, 220-240V~, 50Hz										
Capacity	Cooling	1.1	1.7	2.2	2.8	3.6	4.5	5.6	2.8	3.6	4.5
	Heating	1.3	1.9	2.8	3.2	4.1	5.0	6.3	3.2	4.1	5.0
Input power	W	21	21	23	24	27	33	50	41	71	81
Airflow rate (Cooling / Heating)*	High	530	530	540	550	600	680	820	750	970	1,030
	Med-High	490 / 480	490 / 480	500	520	560	620	660	550	600	680
	Med	450 / 430	450 / 430	460	480	520	560	590	480	520	560
	Med-Low	420 / 380	420 / 380	420	440	480	500	520	440	480	500
	Low	390 / 340	390 / 340	390	400	430	440	460	400	430	440
Sound pressure level (Cooling / Heating)*	Quiet	350 / 300	350 / 300	350	350	390	390	400	350	390	390
	High	34	34	34	35	37	39	45	42	49	50
	Med-High	32 / 31	32 / 31	32	33	34	37	39	35	37	39
	Med	30 / 29	30 / 29	30	31	33	34	36	31	33	34
	Med-Low	28 / 26	28 / 26	28	29	31	32	33	29	31	32
Net Dimensions (H x W x D)	mm	245 x 570 x 570									
	kg	14.5	14.5	15	15	15.5	15.5	17	15	15.5	15.5
Connection pipe diameter	Liquid (Flare)	6.35	6.35	6.35	6.35	6.35	6.35	6.35	6.35	6.35	6.35
	Gas (Flare)	9.52	9.52	9.52	9.52	12.70	12.70	12.70	9.52	12.70	12.70
Drain Hose Diameter (I.D./O.D.)		25 / 32	25 / 32	25 / 32	25 / 32	25 / 32	25 / 32	25 / 32	25 / 32	25 / 32	25 / 32
Cassette Grille	Model name	UTG-UFGH-W									
	Net Dimensions (H x W x D)	49 x 620 x 620									
	Weight	2.3									

Note: Specifications are subject to the following conditions:  
Cooling: Indoor temperature of 27°CDB/19°CWB, and outdoor temperature of 35°CDB/24°CWB.  
Heating: Indoor temperature of 20°CDB/15°CWB, and outdoor temperature of 7°CDB/6°CWB.  
Pipe length: 7.5 m; Height difference between outdoor unit and indoor unit: 0 m. Voltage: 230 [V]  
\*The value is the same for cooling and heating if there is one value.

## Optional parts

\*For more details, please refer to the chapter "Control System List" and "Optional Parts List."

Flesh Air Intake Kit:	UTZ-VXAA	Gas Sensor Kit:	UTY-SGZH / UTY-SGZH1
Insulation kit for high humidity:	UTZ-KXGC	Air Outlet Shutter Plate:	UTR-YDZB
Silver Ion Filter:	UTD-HFAA	External power supply unit:	UTZ-GXXD
Remote Sensor Kit:	UTY-XSZX21	Shut off valve kit:	UTP-GX027A / UTP-GX060A / UTP-GX090A
Cassette Grille:	UTG-UFGH-W		
Expansion Kit:	UTZ-JXXA		

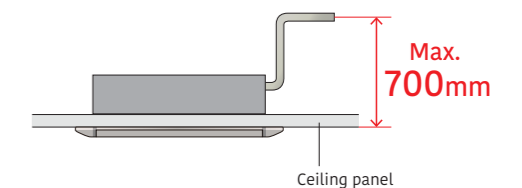

## Dimensions

(Unit: mm)

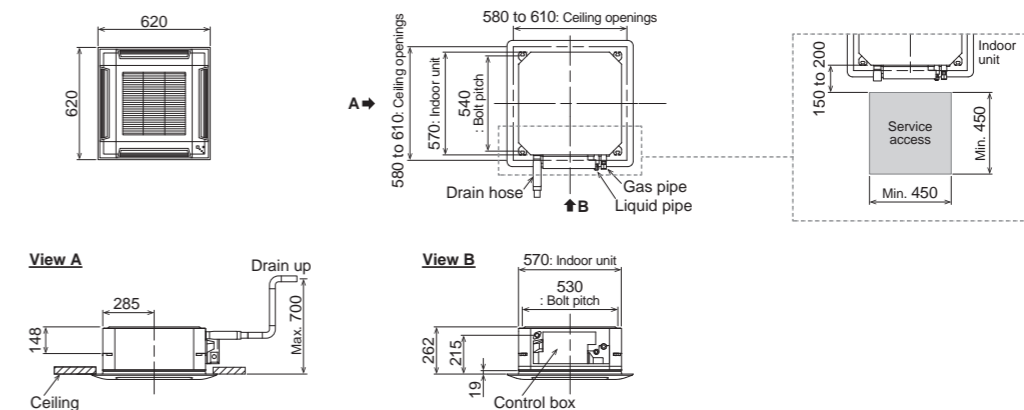

# Cassette

Compact 4-way flow  
Standard  
(Built-in gas sensor)



## Compact and Stylish Panel

The compact and stylish panel fits nicely into a grid type ceiling. The linear design is a perfect fit into a grid of 620 mm x 620 mm in the ceiling.

## Flexible Installation

The unit fits nicely into the decor of a grid type ceiling and can be installed near a lighting or a ventilation opening.

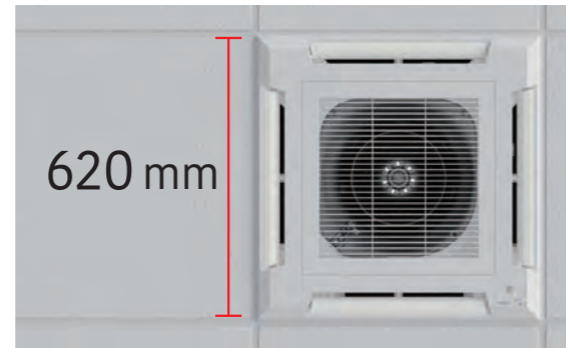

## Easy Maintenance

You can access the unit for maintenance just by removing a ceiling panel right next to the grille. As no inspection hole needs to be cut through the ceiling, no additional construction cost is incurred.



The air inlet grille can be installed to open in any direction for easy maintenance.



## High Ceiling mode

The cassette can be installed up to a height of 3.0 m. (012/014/018).

Model code	Maximum height from floor to ceiling (m)	
	Standard mode	High ceiling mode
004	2.7	—
005	2.7	—
007	2.7	—
009	2.7	—
012	2.7	3.0
014	2.7	3.0
018	2.7	3.0

## Safety measures in Case of Refrigerant Leak

Indoor units compatible with R32 refrigerant are equipped with a refrigerant leak detector. Countermeasures for issues caused by refrigerant inside the room are possible.\*



\*It is necessary to connect the required products according to the floor area of the space requirement and the amount of system refrigerant. For details, please refer to the Design and Technical Manual.

Model: AUXB004HLBH / AUXB005HLBH / AUXB007HLBH  
AUXB009HLBH / AUXB012HLBH / AUXB014HLBH  
AUXB018HLBH



## Specifications

Model name		AUXB004HLBH	AUXB005HLBH	AUXB007HLBH	AUXB009HLBH	AUXB012HLBH	AUXB014HLBH	AUXB018HLBH
Power source		Single phase, 220-240V~, 50Hz						
Capacity	Cooling	1.1	1.7	2.2	2.8	3.6	4.5	5.6
	Heating	1.3	1.9	2.8	3.2	4.1	5.0	6.3
Input power		21	21	23	24	27	33	50
Airflow rate (Cooling / Heating)*	High	530	530	540	550	600	680	820
	Med-High	490 / 480	490 / 480	500	520	560	620	660
	Med	450 / 430	450 / 430	460	480	520	560	590
	Med-Low	420 / 380	420 / 380	420	440	480	500	520
	Low	390 / 340	390 / 340	390	400	430	440	460
Quiet		350 / 300	350 / 300	350	350	390	390	400
Sound pressure level (Cooling / Heating)*	High	34	34	34	35	37	39	45
	Med-High	32 / 31	32 / 31	32	33	34	37	39
	Med	30 / 29	30 / 29	30	31	33	34	36
	Med-Low	28 / 26	28 / 26	28	29	31	32	33
	Low	27 / 24	27 / 24	27	27	29	30	30
Quiet		25 / 21	25 / 21	25	25	27	27	27
Net Dimensions (H x W x D)		mm 245 x 570 x 570						
Weight		14.5	14.5	15	15	15.5	15.5	17
Connection pipe diameter	Liquid (Flare)	6.35	6.35	6.35	6.35	6.35	6.35	6.35
	Gas (Flare)	9.52	9.52	9.52	9.52	12.70	12.70	12.70
Drain Hose Diameter (I.D./O.D.)		25 / 32	25 / 32	25 / 32	25 / 32	25 / 32	25 / 32	25 / 32
Cassette Grille		Model name: UTG-UFQH-W, Net Dimensions (H x W x D): mm 49 x 620 x 620, Weight: kg 2.3						

Note: Specifications are subject to the following conditions:  
Cooling: Indoor temperature of 27°CDB/19°CWB, and outdoor temperature of 35°CDB/24°CWB.  
Heating: Indoor temperature of 20°CDB/15°CWB, and outdoor temperature of 7°CDB/6°CWB.  
Pipe length: 7.5 m; Height difference between outdoor unit and indoor unit: 0 m. Voltage: 230 [V]  
\*The value is the same for cooling and heating if there is one value.

## Optional parts

\*For more details, please refer to the chapter "Control System List" and "Optional Parts List."

Flesh Air Intake Kit:	UTZ-VXAA	Gas Sensor Kit:	UTY-SGZH / UTY-SGZH1
Insulation kit for high humidity:	UTZ-KXGC	Air Outlet Shutter Plate:	UTR-YDZB
Silver Ion Filter:	UTD-HFAA	External power supply unit:	UTZ-GXXD
Remote Sensor Kit:	UTY-XSZXZ1	Shut off valve kit:	UTP-GX027A / UTP-GX060A / UTP-GX090A
Cassette Grille:	UTG-UFQH-W		
Expansion Kit:	UTZ-JXXA		

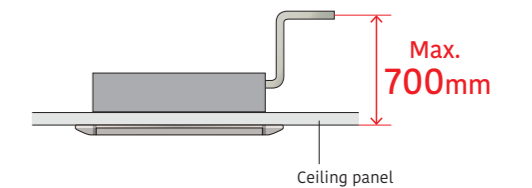

## Dimensions

(Unit: mm)

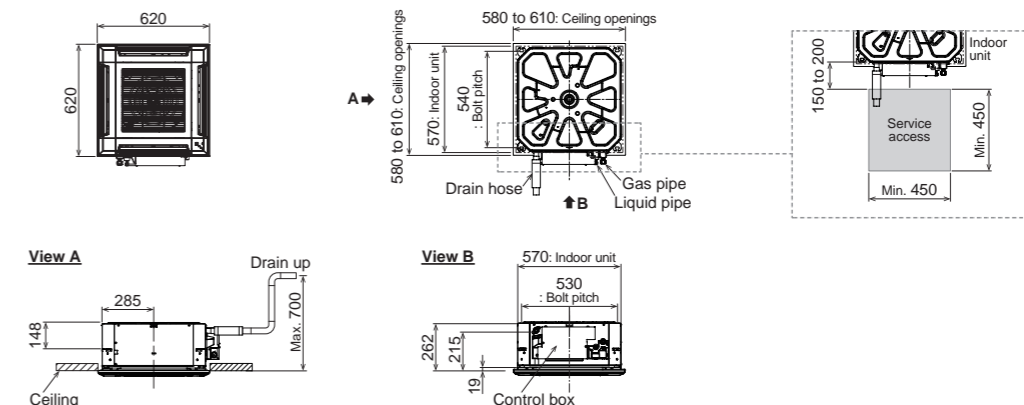

# Cassette

Circular Flow  
Slim  
(Built-in gas sensor)



## Unique Circular Flow Design

This Cassette type air conditioner is equipped with a high performance DC fan motor, a turbo fan, and a louver to propel powerful airflows in all directions.

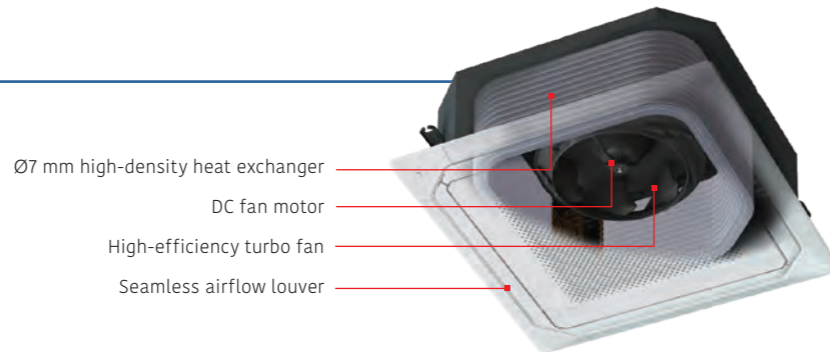

## Uniform Temperature Air Conditioning

Achieve a comfortable air conditioning spread to every corner of the room thanks to the circular flow and wide vertical airflow.

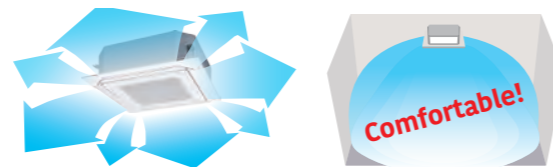

## Individual Louver Control

Each louver can be set individually by the Touch panel wired remote controller so the user can enjoy the comfort of different directional airflows according to the room layout.

\* UTY-RNRGZ6 / UTY-DCGGZ4 / UTY-RVRG only



Comfortable air conditioning by preventing direct blowing of cold air and by providing swinging air flow simultaneously.

Provides efficient air conditioning based on the room layout

## Safety measures in Case of Refrigerant Leak

Indoor units compatible with R32 refrigerant are equipped with a refrigerant leak detector. Countermeasures for issues caused by refrigerant inside the room are possible.\*



\*It is necessary to connect the required products according to the floor area of the space requirement and the amount of system refrigerant. For details, please refer to the Design and Technical Manual.

## The Occupancy Sensor Contributes to Further Energy Savings

Energy saving operation starts automatically by detecting the motion of a person. Two modes of save operation mode and stop mode can be selected.

\* UTY-RNRGZ6 / UTY-DCGGZ4 / UTY-RVRG only

**Model: AUXM009HLBH / AUXM012HLBH / AUXM014HLBH  
AUXM018HLBH / AUXM024HLBH / AUXM030HLBH  
AUXN018HLBH**  
\* Production by order



## Specifications

Model name		AUXM009HLBH	AUXM012HLBH	AUXM014HLBH	AUXM018HLBH	AUXM024HLBH	AUXM030HLBH	AUXN018HLBH
Power source		Single phase, 220-240V~, 50Hz						
Capacity	Cooling	2.8	3.6	4.5	5.6	7.1	9.0	5.6
	Heating	3.2	4.0	5.0	6.3	8.0	10.0	6.3
Input power		18	18	18	19	28	55	55
Airflow rate	High	930	930	930	950	1,160	1,520	1,520
	Med-High	900	900	900	930	1,080	1,190	1,190
	Med	870	870	870	900	950	1,100	1,100
	Med-Low	840	840	840	870	930	950	950
	Low	810	810	810	840	900	930	930
	Quiet	780	780	780	810	810	810	810
Sound pressure level	High	31	31	31	32	35	42	42
	Med-High	30	30	30	31	34	36	36
	Med	30	30	30	30	32	34	34
	Med-Low	29	29	29	29	31	32	32
	Low	29	29	29	29	30	31	31
	Quiet	28	28	28	28	28	28	28
Dimensions (H × W × D)		mm 246 × 840 × 840						
Weight		24.5	24.5	24.5	25.0	25.0	25.0	25.0
Connection pipe diameter	Liquid (Flare)	6.35	6.35	6.35	6.35	9.52	9.52	6.35
	Gas (Flare)	9.52	12.7	12.7	12.7	15.88	15.88	12.7
Drain Hose Diameter (I.D./O.D.)		25/32	25/32	25/32	25/32	25/32	25/32	25/32
Cassette Grille	Model name	UTG-UKGC-W / UTG-UKGA-B						
	Dimensions (H × W × D)	mm 53×950×950						
	Weight	kg 6.0						

Note: Specifications are subject to the following conditions:  
Cooling: Indoor temperature of 27°CDB/19°CWB, and outdoor temperature of 35°CDB/24°CWB.  
Heating: Indoor temperature of 20°CDB/15°CWB, and outdoor temperature of 7°CDB/6°CWB.  
Pipe length: 7.5 m; Height difference between outdoor unit and indoor unit: 0 m. Voltage: 230 [V]

## Optional parts

\*For more details, please refer to the chapter "Control System List" and "Optional Parts List."

Occupancy Sensor Kit: UTY-SHZXC	Air Outlet Shutter Plate: UTR-YDZK	Silver Ion Filter: UTD-HFRA
Wide Panel: UTG-AKXA-W	Insulation Kit for high humidity: UTZ-KXRA	Remote Sensor Kit: UTY-XS2X21
Panel Spacer: UTG-BKXA-W	Cassette Grille: UTG-UKGC-W, UTG-UKGA-B	Shut off valve kit: UTP-GX027A / UTP-GX060A / UTP-GX090A
Fresh Air Intake Kit: UTZ-VXRA	External power supply unit: UTZ-GXXD	
Gas Sensor Kit: UTY-SGZH / UTY-SGZH21	Expansion kit: UTZ-JXXA	

## Dimensions

(Unit: mm)

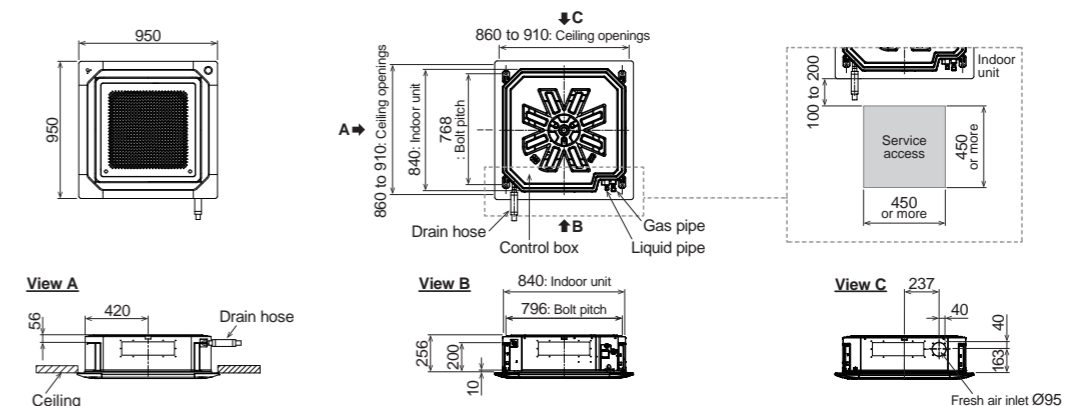

# Cassette

## Circular Flow

### Large

(Built-in gas sensor)



### Unique Circular Flow Design

This Cassette type air conditioner is equipped with a high performance DC fan motor, a turbo fan, and a louver to propel powerful airflows in all directions.

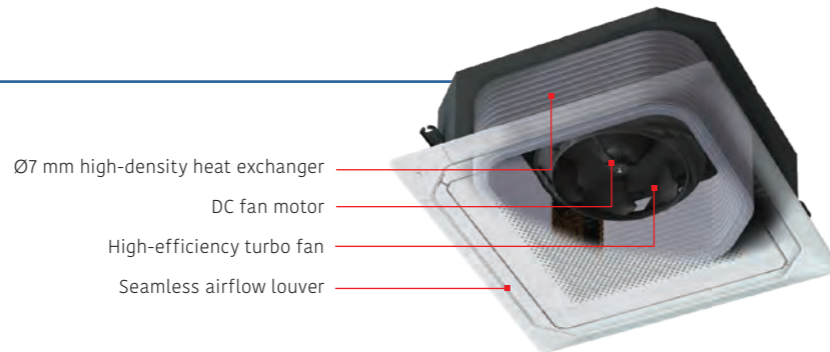

### Uniform Temperature Air Conditioning

Achieve a comfortable air conditioning spread to every corner of the room thanks to the circular flow and wide vertical airflow.

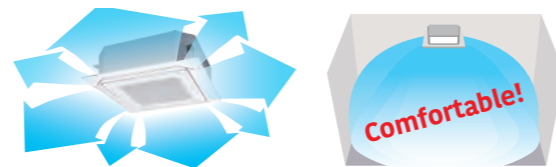

### Individual Louver Control

Each louver can be set individually by the Touch panel wired remote controller so the user can enjoy the comfort of different directional airflows according to the room layout.

\* UTY-RNRGZ6 / UTY-DCGGZ4 / UTY-RVRG only



Comfortable air conditioning by preventing direct blowing of cold air and by providing swinging air flow simultaneously.

Provides efficient air conditioning based on the room layout

### Safety measures in Case of Refrigerant Leak

Indoor units compatible with R32 refrigerant are equipped with a refrigerant leak detector. Countermeasures for issues caused by refrigerant inside the room are possible.\*



\*It is necessary to connect the required products according to the floor area of the space requirement and the amount of system refrigerant. For details, please refer to the Design and Technical Manual.

### The Occupancy Sensor Contributes to Further Energy Savings

Energy saving operation starts automatically by detecting the motion of a person. Two modes of save operation mode and stop mode can be selected.

\* UTY-RNRGZ6 / UTY-DCGGZ4 / UTY-RVRG only

Model: AUXK018HLBH / AUXK024HLBH / AUXK030HLBH  
 AUXK034HLBH / AUXK036HLBH / AUXK045HLBH  
 AUXK054HLBH



### Specifications

Model name		AUXK018HLBH	AUXK024HLBH	AUXK030HLBH	AUXK034HLBH	AUXK036HLBH	AUXK045HLBH	AUXK054HLBH
Power source		Single phase, 220-240V~, 50Hz						
Capacity	Cooling	5.6	7.1	9.0	10.0	11.2	12.5	14.0
	Heating	6.3	8.0	10.0	11.2	12.5	14.0	16.0
Input power		40	40	52	52	66	94	125
Airflow rate	High	1,420	1,420	1,460	1,460	1,620	1,820	2,040
	Med-High	1,360	1,360	1,400	1,400	1,500	1,590	1,800
	Med	1,300	1,300	1,340	1,340	1,400	1,500	1,590
	Med-Low	1,270	1,270	1,300	1,300	1,340	1,400	1,440
	Low	1,200	1,200	1,280	1,280	1,280	1,300	1,300
	Quiet	1,150	1,150	1,150	1,150	1,150	1,150	1,150
Sound pressure level	High	38	38	39	39	41	44	47
	Med-High	37	37	38	38	40	42	45
	Med	36	36	37	37	38	40	42
	Med-Low	35	35	36	36	37	38	39
	Low	34	34	36	36	36	36	36
	Quiet	33	33	33	33	33	33	33
Dimensions (H × W × D)		mm 288×840×840						
Weight		27.0	27.0	29.5	29.5	29.5	29.5	29.5
Connection pipe diameter	Liquid (Flare)	6.35	9.52	9.52	9.52	9.52	9.52	9.52
	Gas (Flare)	12.7	15.88	15.88	15.88	15.88	15.88	15.88
Drain Hose Diameter (I.D./O.D.)		25/32	25/32	25/32	25/32	25/32	25/32	25/32
Cassette Grille		mm 53×950×950						
Model name		UTG-UKGC-W / UTG-UKGA-B						
Dimensions (H × W × D)		mm 53×950×950						
Weight		kg 6.0						

Note: Specifications are subject to the following conditions:  
 Cooling: Indoor temperature of 27°CDB/19°CWB, and outdoor temperature of 35°CDB/24°CWB.  
 Heating: Indoor temperature of 20°CDB/15°CWB, and outdoor temperature of 7°CDB/6°CWB.  
 Pipe length: 7.5 m; Height difference between outdoor unit and indoor unit: 0 m. Voltage: 230 [V]

### Optional parts

\*For more details, please refer to the chapter "Control System List" and "Optional Parts List."

Occupancy Sensor Kit: UTY-SHZXC	Air Outlet Shutter Plate: UTR-YDZK	Silver Ion Filter: UTD-HFRA
Wide Panel: UTG-AKXA-W	Insulation Kit for high humidity: UTZ-KXRA	Remote Sensor Kit: UTY-XS2X21
Panel Spacer: UTG-BKXA-W	Cassette Grille: UTG-UKGC-W, UTG-UKGA-B	Shut off valve kit: UTP-GX027A / UTP-GX060A / UTP-GX090A
Fresh Air Intake Kit: UTZ-VXRA	External power supply unit: UTZ-GXXD	
Gas Sensor Kit: UTY-SGZH / UTY-SGZH21	Expansion kit: UTZ-JXXA	

### Dimensions

(Unit: mm)

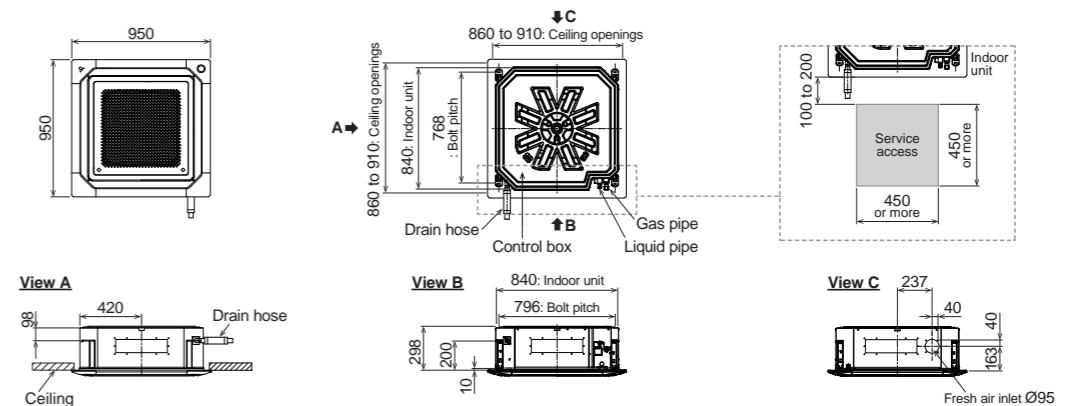

# Cassette

1-Way Flow  
(Built-in gas sensor)



## Compact Chassis Size

The compact size allows easy installation in a variety of commercial facilities and environments.

- The height of the chassis is less than 200 mm for all models.
- All 4 to 12 kBtu models are less than 1,000 mm wide.
- The depth of the chassis is 570 mm, which fits nicely into a grid type ceiling.

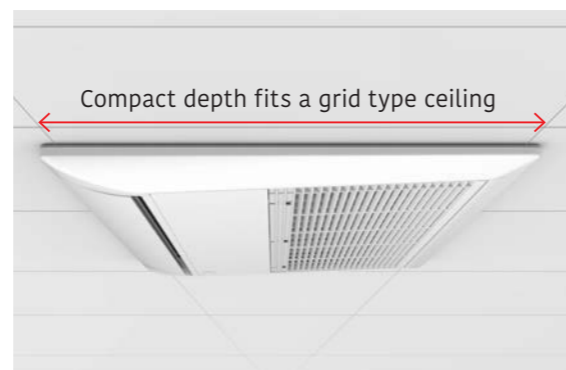

Dimensions (Panel size) (Unit: mm)

	4	5	7	9	12	14	18	24
H			198 (43)				198 (43)	
W			785 (950)				1,190 (1,360)	
D			570 (620)				570 (620)	

## Wide Airflow Range

A large flap with a wide range of movements, equipped with louvers arranged triangularly, sends air into every corner of the room.

In cooling mode, the left/right airflow reaches every corner of the room without directly touching the human body to provide comfortable air conditioning.



In heating mode, warm air is directed downward toward the floor to warm the feet and lower body, while the head is kept relatively cool.

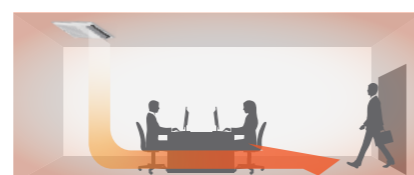

Note: This is a conceptual drawing. The performance of an air conditioner may vary depending on where it is installed, the size of the room, and its distance from the wall.

## Safety measures in Case of Refrigerant Leak

Indoor units compatible with R32 refrigerant are equipped with a refrigerant leak detector. Countermeasures for issues caused by refrigerant inside the room are possible.\*



\*It is necessary to connect the required products according to the floor area of the space requirement and the amount of system refrigerant. For details, please refer to the Design and Technical Manual.

## Quiet Mode

The low operating noise makes the model ideal for use in hotel rooms.



Model: AUXV004HLBH / AUXV005HLBH / AUXV007HLBH  
AUXV009HLBH / AUXV012HLBH / AUXV014HLBH  
AUXV018HLBH / AUXV024HLBH



AUXV004/005/007/009/012HLBH



AUXV014/018/024HLBH

## Specifications

Model name		AUXV004HLBH	AUXV005HLBH	AUXV007HLBH	AUXV009HLBH	AUXV012HLBH	AUXV014HLBH	AUXV018HLBH	AUXV024HLBH	
Power source		Single phase, 220-240V~, 50Hz								
Capacity	Cooling	1.1	1.7	2.2	2.8	3.6	4.5	5.6	7.1	
	Heating	1.3	1.9	2.8	3.2	4.0	5.0	6.3	8.0	
Input power		27	27	40	40	55	37	65	142	
Airflow rate*	High	460	460	550	550	670	720	970	1,350	
	Med-High	440	440	440	440	520	660	900	1,180	
	Med	420	420	420	420	480	630	820	1,020	
	Med-Low	400	400	400	400	450	600	740	860	
	Low	380	380	380	380	410	580	660	700	
	Quiet	360	360	360	360	360	550	580	610	
Sound pressure level*	High	38	38	42	42	45	37	46	55	
	Med-High	37	37	37	37	41	36	44	49	
	Med	36	36	36	36	39	35	42	47	
	Med-Low	35	35	35	35	38	34	39	42	
	Low	33	33	33	33	36	33	36	39	
	Quiet	32	32	32	32	32	32	34	36	
Net Dimensions (H x W x D)		mm 198 x 785 x 570						mm 198 x 1,190 x 570		
Weight		17.5	17.5	18.5	18.5	18.5	26.0	26.0	26.5	
Connection pipe diameter	Liquid (Flare)	6.35	6.35	6.35	6.35	6.35	6.35	6.35	9.52	
	Gas (Flare)	9.52	9.52	9.52	9.52	12.7	12.7	12.7	15.88	
Drain Hose Diameter (I.D./O.D.)		25/32						25/32		
Cassette Grille	Model name	UTG-UNGC-W						UTG-UNGD-W		
	Net Dimensions (H x W x D)	mm 43 x 950 x 620						mm 43 x 1,360 x 620		
Weight		kg 6.5						kg 8.5		

Note: Specifications are subject to the following conditions:  
Cooling: Indoor temperature of 27°CDB/19°CWB, and outdoor temperature of 35°CDB/24°CWB.  
Heating: Indoor temperature of 20°CDB/(15°CWB), and outdoor temperature of 7°CDB/6°CWB.  
Pipe length: 7.5 m; Height difference between outdoor unit and indoor unit: 0 m. Voltage: 230 [V]

## Optional parts

\*For more details, please refer to the chapter "Control System List" and "Optional Parts List."

- Cassette Grille: UTG-UNGC-W (004-012), UTG-UNGD-W (014-024)
- External power supply unit: UTZ-GXXD
- Remote sensor kit: UTY-XSZXZ1
- Shut off valve kit: UTP-GX027A, UTP-GX060A, UTP-GX090A
- Gas Sensor kit: UTY-SGZH, UTY-SGZHZ1
- Expansion kit: UTZ-JXXA

## Flexible Installation

The L-shaped pipe kit allows for more flexible installation. Equipped with a built-in drain pump as standard, which enables a maximum pipe height difference of 700 m from the ceiling.

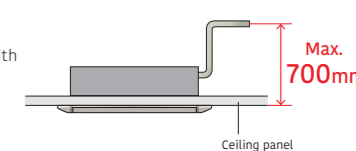

## Dimensions

(Unit: mm)

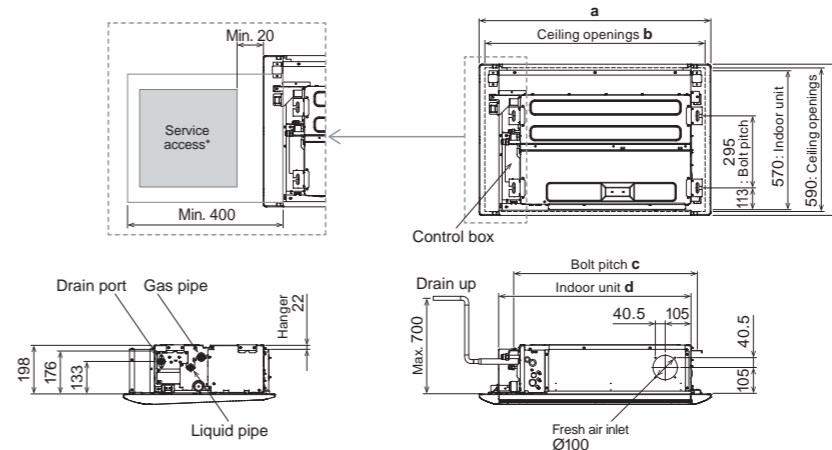

	AUXV 004/005/007/009/012 HLBH	AUXV 014/018/024 HLBH
a	950	1,360
b	920	1,330
c	752	1,152
d	785	1,190

\*The design of the service access depends on the installation method. Refer to the installation manual for more information.

# Duct

Low static pressure  
Mini duct  
(Built-in gas sensor)

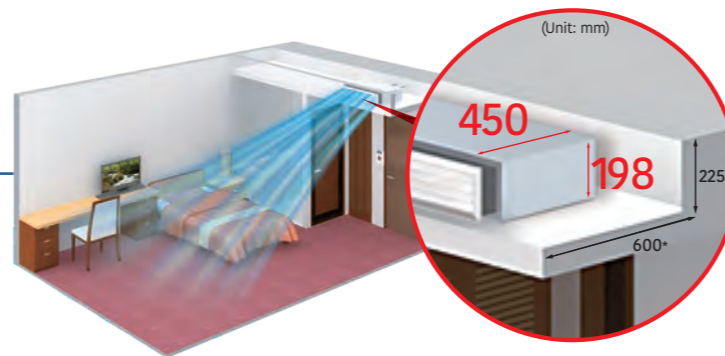

## Space Saving Design

- Fits into a space 198 mm high and 450 mm deep

\*: Minimum clearance requirement

## Optimum Airflow Path and Low Noise Operation

The stabilized airflow reduces the noise level significantly.

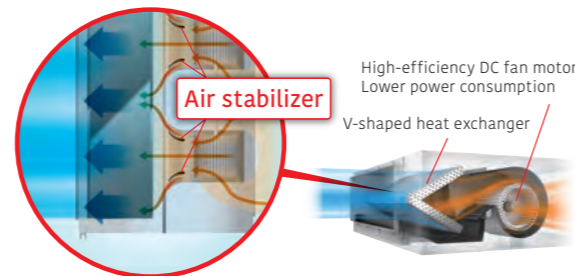

## 6-Speed Control\*

Multistep airflow adjustment allows installation in a quiet location.

Low noise  
**20 dB(A)**

at 004-005 model

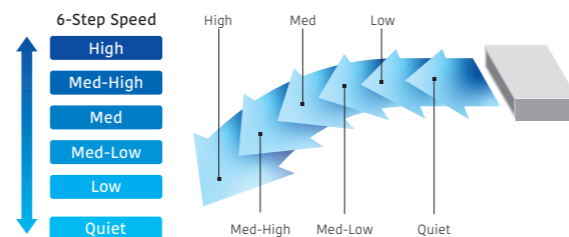

\* Remote controller is compatible with the following:  
UTY-RVRG / UTY-RNRG26 / UTY-RLRG / UTY-R5RG21 / UTY-RHRG21 / UTY-DCGG24 / UTY-ALGX21 / UTY-APGX21

## Safety measures in Case of Refrigerant Leak

Indoor units compatible with R32 refrigerant are equipped with a refrigerant leak detector. Countermeasures for issues caused by refrigerant inside the room are possible.\*



\*It is necessary to connect the required products according to the floor area of the space requirement and the amount of system refrigerant. For details, please refer to the Design and Technical Manual.

## Easy to Design and Maintain for Drain

Indoor unit design for easy maintenance Parts can be replaced from the side of the unit where maintenance is easier.

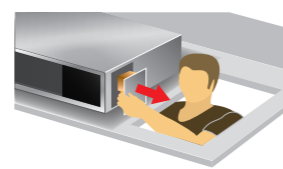

A drain pump is built into the unit as standard: Parts can be accessed and replaced through the side of the unit for easy maintenance.

Model: ARXK004HLBH / ARXK005HLBH / ARXK007HLBH  
ARXK009HLBH / ARXK012HLBH / ARXK014HLBH  
ARXK018HLBH / ARXK024HLBH

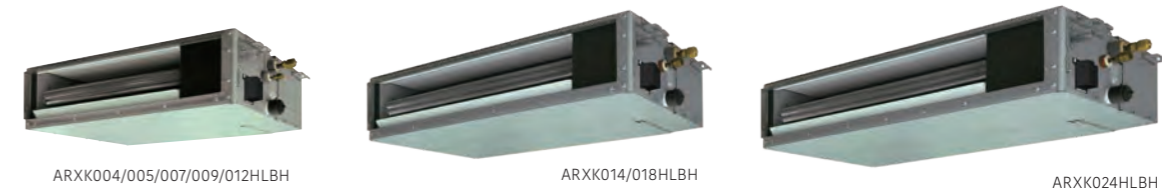

## Specifications

Model name	ARXK004HLBH	ARXK005HLBH	ARXK007HLBH	ARXK009HLBH	ARXK012HLBH	ARXK014HLBH	ARXK018HLBH	ARXK024HLBH
Power source	Single phase, 220-240V~, 50Hz							
Capacity	Cooling	1.1	1.7	2.2	2.8	3.6	4.5	5.6
	Heating	1.3	1.9	2.8	3.2	4.0	5.0	6.3
Input power	W	26	26	28	33	46	49	102
Airflow rate	High	460	460	460	540	640	820	1,150
	Med-High	440	440	440	490	590	750	990
	Med	420	420	420	450	530	680	840
	Med-Low	400	400	400	410	470	610	690
	Low	370	370	370	370	410	540	590
Quiet	340	340	340	340	340	470	470	610
Static pressure range	Pa	0 to 30	0 to 30	0 to 30	0 to 30	0 to 30	0 to 50	0 to 50
Standard static pressure	Pa	10	10	10	10	10	15	15
Sound pressure level	High	25	25	26	26	29	29	35
	Med-High	24	24	25	25	27	27	30
	Med	23	23	24	24	26	26	28
	Med-Low	22	22	23	23	25	25	26
	Low	21	21	22	22	24	24	24
Quiet	20	20	21	21	22	22	22	
Net Dimensions (H × W × D)	mm	198×700×450			198×900×450			198×1,100×450
Weight	kg	14.5	14.5	15.5	15.5	16.0	19.0	22.5
Connection pipe diameter	Liquid (Flare)	6.35	6.35	6.35	6.35	6.35	6.35	9.52
	Gas (Flare)	9.52	9.52	9.52	9.52	12.7	12.7	15.88
Drain Hose Diameter (I.D./O.D.)		25/32	25/32	25/32	25/32	25/32	25/32	25/32

Note: Specifications are subject to the following conditions:  
Cooling: Indoor temperature of 27°CDB/19°CWB, and outdoor temperature of 35°CDB/24°CWB.  
Heating: Indoor temperature of 20°CDB/(15°CWB), and outdoor temperature of 7°CDB/6°CWB.  
Pipe length: 7.5 m; Height difference between outdoor unit and indoor unit: 0 m. Voltage: 230 [V]

## Optional parts

\*For more details, please refer to the chapter "Control System List" and "Optional Parts List."

- Remote sensor unit: UTY-XSZX21  
Silver Ion Filter: UTD-HFTA (004-012)  
UTD-HFTB (014/018)  
UTD-HFTC (024)  
External power supply unit: UTZ-GXDD  
Shut off valve kit: UTP-GX027A / UTP-GX060A / UTP-GX090A

- Auto Louver Grille Kit: UTD-GXTA-W (004-012)  
UTD-GXTB-W (014/018)  
UTD-GXTC-W (024)  
Gas Sensor Kit: UTY-SGZH,  
UTY-SGZH21  
Expansion kit: UTZ-JXXA

## Auto Louver Grille Kit (Optional)

The slim design of the unit provides comfortable cooling and heating air conditioning over a wide area. The optional automatic louver grille, which fits nicely into any interior decor, provides comfortable air conditioning (Optional)



## Dimensions

(Unit: mm)

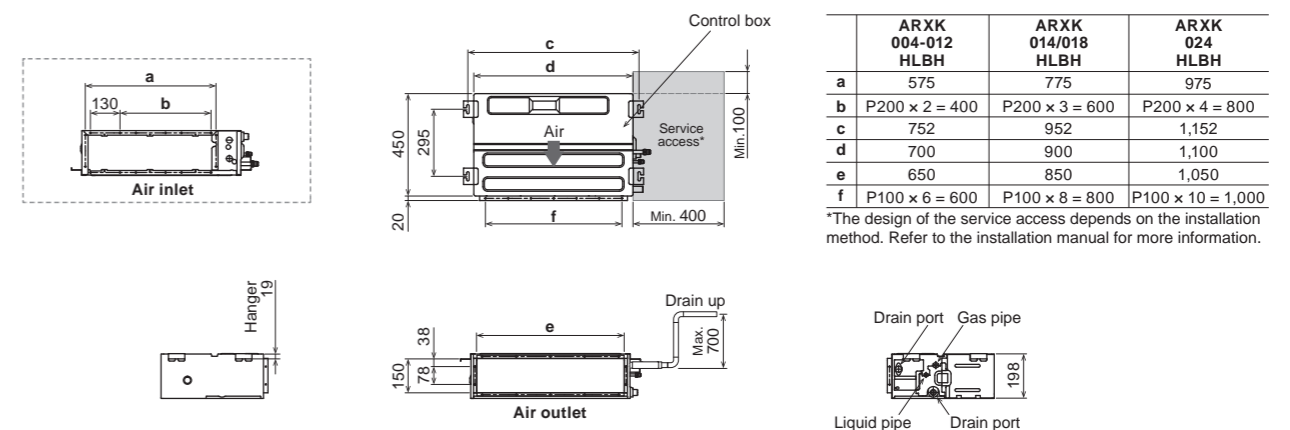

# Duct

Low static pressure  
Slim duct  
(Built-in gas sensor)



## Slim Design

Slim design allows for installation in a tight ceiling space.

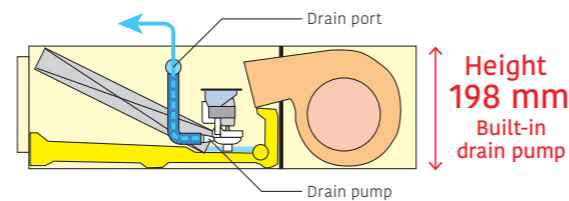

## Air Intake

Air intake direction can be selected to match the installation site.

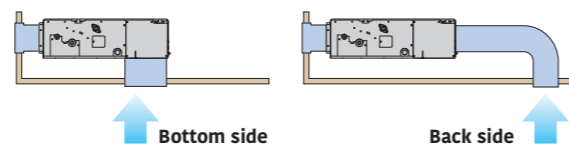

## Wide Range of Static Pressures

The use of a DC fan motor makes it possible to adjust the static pressure between 0 and 90 Pa. The static pressure range can be changed by a remote controller.

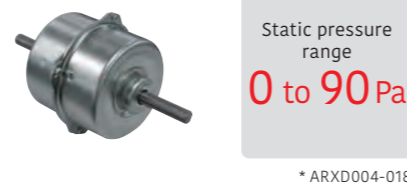

## Safety measures in Case of Refrigerant Leak

Indoor units compatible with R32 refrigerant are equipped with a refrigerant leak detector. Countermeasures for issues caused by refrigerant inside the room are possible.\*



\*It is necessary to connect the required products according to the floor area of the space requirement and the amount of system refrigerant. For details, please refer to the Design and Technical Manual.

## Filter (Accessory)

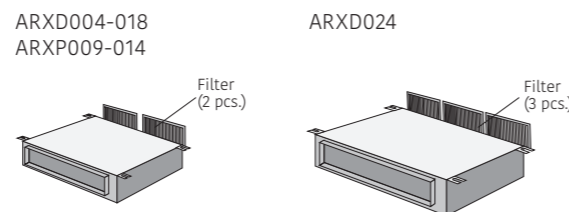

Model: ARXD004HLBH / ARXD005HLBH / ARXD007HLBH / ARXD009HLBH  
ARXD012HLBH / ARXD014HLBH / ARXD018HLBH / ARXD024HLBH

ARXP009HLAH / ARXP012HLAH / ARXP014HLAH

\* Production by order. This product does not include a gas sensor.

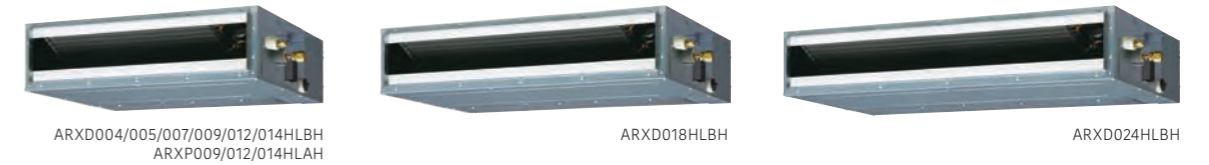

## Specifications

Model name		ARXD004HLBH	ARXD005HLBH	ARXD007HLBH	ARXD009HLBH	ARXD012HLBH	ARXD014HLBH	ARXD018HLBH	ARXD024HLBH	ARXP009HLAH	ARXP012HLAH	ARXP014HLAH
Power source		Single phase, 220-240V~, 50Hz										
Capacity	Cooling	1.1	1.7	2.2	2.8	3.6	4.5	5.6	7.1	2.8	3.6	4.5
	Heating	1.3	1.9	2.8	3.2	4.0	5.0	6.3	8.0	3.2	4.0	5.0
Input power		38	38	41	47	48	84	76	107	77	128	128
		W										
Airflow rate	High	530	530	550	600	580	790	930	1,250	770	940	940
	Med-High	480	480	520	550	550	720	880	1,180	630	810	810
	Med	440	440	480	500	520	640	780	1,060	530	660	660
	Med-Low	410	410	450	460	480	560	670	930	480	580	580
	Low	370	370	400	400	430	470	580	810	430	490	490
Quiet	320	320	360	360	350	370	510	640	380	390	390	
Static pressure range		0 to 90	0 to 90	0 to 90	0 to 90	0 to 90	0 to 90	0 to 90	0 to 50	0 to 25	0 to 25	0 to 25
Standard static pressure		25	25	25	25	25	25	25	25	25	25	25
Sound pressure level	High	26	26	28	29	30	34	34	35	36	40	40
	Med-High	26	26	26	27	28	32	31	32	32	38	38
	Med	25	25	25	25	27	30	29	30	28	33	33
	Med-Low	24	24	24	24	26	28	27	27	27	31	31
	Low	22	22	22	22	24	25	25	24	25	27	27
Quiet	21	21	21	21	22	22	23	21	23	24	24	
Net Dimensions (H × W × D)	mm	198×700×620						198×900×620	198×1,100×620	198×700×620		
Weight	kg	16.0	16.0	16.5	16.5	17.0	17.0	21.0	25.0	16.5	17.0	17.0
Connection pipe diameter	Liquid (Flare)	6.35	6.35	6.35	6.35	6.35	6.35	6.35	9.52	6.35	6.35	6.35
	Gas (Flare)	9.52	9.52	9.52	9.52	12.7	12.7	12.7	15.88	9.52	12.7	12.7
Drain Hose Diameter (I.D./O.D.)		25/32	25/32	25/32	25/32	25/32	25/32	25/32	25/32	25/32	25/32	25/32

Note: Specifications are subject to the following conditions:  
Cooling: Indoor temperature of 27°CDB/19°CWB, and outdoor temperature of 35°CDB/24°CWB.  
Heating: Indoor temperature of 20°CDB/(15°CWB), and outdoor temperature of 7°CDB/6°CWB.  
Pipe length: 7.5 m; Height difference between outdoor unit and indoor unit: 0 m. Voltage: 230 [V]

## Optional parts

\*For more details, please refer to the chapter "Control System List" and "Optional Parts List."

Remote sensor unit:	UTY-XSZXZ1	Auto Louver Grille Kit:	UTD-GXTA-W (004-014)
External power supply unit:	UTZ-GXXD		UTD-GXTB-W (018)
Shut off valve kit:	UTP-GX027A /		UTD-GXTC-W (024)
	UTP-GX060A /	Silver Ion Filter:	UTD-HFTA (004-014)
	UTP-GX090A		UTD-HFTB (018)
Expansion Kit:	UTZ-JXXA		UTD-HFTC (024)
Gas Sensor Kit:	UTY-SGZH / UTY-SGZH21		

## Auto Louver Grille Kit (Optional)

The optional clean-looking flat Auto louver blends into any interior and provides a comfortable airflow.



## Dimensions

(Unit: mm)

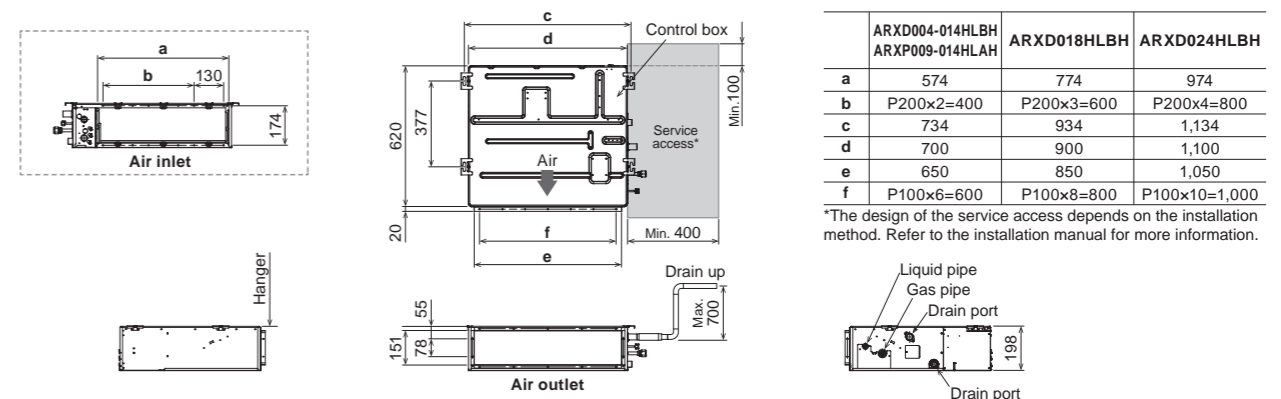

# Duct

Medium static pressure  
(Built-in gas sensor)



## Slim & Compact Design

The product has reduced the height to 240 mm, making it more compact. The slim design fits nicely into narrow spaces under the ceiling.



## Easy Maintenance

The indoor unit have large panels on both sides providing easy maintenance in narrow spaces.



**Easy inspection of drain hose**  
A drain hose is an accessory, making it easy to design ditch even in narrow spaces under the ceiling. The whole drain hose can be removed for easy replacement and cleaning.

## Automatic Airflow Adjustment Function

This unique and innovative function detects required air flow in each application case and automatically adjust the volume.



## Safety measures in Case of Refrigerant Leak

Indoor units compatible with R32 refrigerant are equipped with a refrigerant leak detector. Countermeasures for issues caused by refrigerant inside the room are possible.\*



\*It is necessary to connect the required products according to the floor area of the space requirement and the amount of system refrigerant. For details, please refer to the Design and Technical Manual.

## Wide Range of Static Pressures

Static pressures can be changed in the range of 30 to 150 Pa.

Static pressure range  
**30 to 150 Pa**

\*ARXL only

**Model: ARXL007HTBH / ARXL009HTBH / ARXL012HTBH / ARXL014HTBH / ARXL018HTBH  
ARXL024HTBH / ARXL030HTBH / ARXL036HTBH / ARXL045HTBH  
ARXP018HTBH / ARXP030HTBH**  
\* Production by order



ARXL007/009/012/014/018HTBH



ARXL024/030HTBH



ARXL036/045HTBH  
ARXP018/030HTBH

## Specifications

Model name	ARXL007HTBH	ARXL009HTBH	ARXL012HTBH	ARXL014HTBH	ARXL018HTBH	ARXL024HTBH	ARXL030HTBH	ARXL036HTBH	ARXL045HTBH	ARXP018HTBH	ARXP030HTBH	
Power source	Single phase, 220-240V~, 50Hz											
Capacity	Cooling	2.2	2.8	3.6	4.5	5.6	7.1	9.0	11.2	12.5	5.6	9.0
	Heating	2.8	3.2	4.0	5.0	6.3	8.0	10.0	12.5	14.0	6.3	10.0
Input power		48	48	55	72	112	105	193	192	272	100	210
		W										
Airflow rate	High	650	650	700	800	970	1,230	1,630	2,070	2,360	1,540	2,160
	Med-High	590	590	630	720	880	1,140	1,460	1,920	2,160	1,500	1,990
	Med	540	540	570	660	780	1,040	1,280	1,760	1,940	1,440	1,810
	Med-Low	490	490	510	600	680	940	1,100	1,600	1,720	1,380	1,630
	Low	440	440	450	540	580	840	920	1,440	1,500	1,320	1,450
Quiet	390	390	390	480	480	740	860	1,280	1,390	1,280	1,280	
Static pressure range	Pa	30 to 150	30 to 150	30 to 150	30 to 150	30 to 150	30 to 150	30 to 150	30 to 150	30 to 40	30 to 50	
Standard static pressure	High	29	29	30	33	36	34	39	38	41	33	39
	Med-High	27	27	28	30	34	32	37	36	39	32	37
	Med	25	25	26	28	31	30	33	34	37	31	35
	Med-Low	23	23	24	26	28	28	30	32	34	30	32
	Low	22	22	22	24	25	26	26	30	31	29	30
Quiet	20	20	20	23	22	23	25	28	29	28	27	
Net Dimensions (H × W × D)	mm	240×700×700			240×1,000×700			240×1,400×700				
Weight	kg	24.5	24.5	24.5	25.0	25.0	32.0	32.0	42.5	42.5	42.5	42.5
Connection pipe diameter	Liquid (Flare)	6.35	6.35	6.35	6.35	6.35	9.52	9.52	9.52	9.52	6.35	9.52
	Gas (Flare)	9.52	9.52	12.7	12.7	12.7	15.88	15.88	15.88	15.88	12.7	15.88
Drain Hose Diameter (I.D./O.D.)		25/32	25/32	25/32	25/32	25/32	25/32	25/32	25/32	25/32	25/32	

Note: Specifications are subject to the following conditions:  
Cooling: Indoor temperature of 27°CDB/19°CWB, and outdoor temperature of 35°CDB/24°CWB.  
Heating: Indoor temperature of 20°CDB/(15°CWB), and outdoor temperature of 7°CDB/6°CWB.  
Pipe length: 7.5 m; Height difference between outdoor unit and indoor unit: 0 m. Voltage: 230 [V]

## Optional parts

\*For more details, please refer to the chapter "Control System List" and "Optional Parts List."

Remote sensor unit: UTY-XSZXZ1	Silver Ion Filter: UTD-HFNC (ARXL007-018)	Long Life Filter: UTD-LFDC (ARXL007-018)
External power supply unit: UTZ-GXXD	UTD-HFNB (ARXL024/030)	UTD-LFDB (ARXL024/030)
Gas Sensor Kit: UTY-SGZH	UTD-HFNA (ARXL036/045, ARXP018/030)	UTD-LFDA (ARXL036/045, ARXP018/030)
UTY-SGZH21	Expansion kit: UTZ-JXXA	Shut off valve kit: UTP-GX027A / UTP-GX060A / UTP-GX090A

## Dimensions

(Unit: mm)

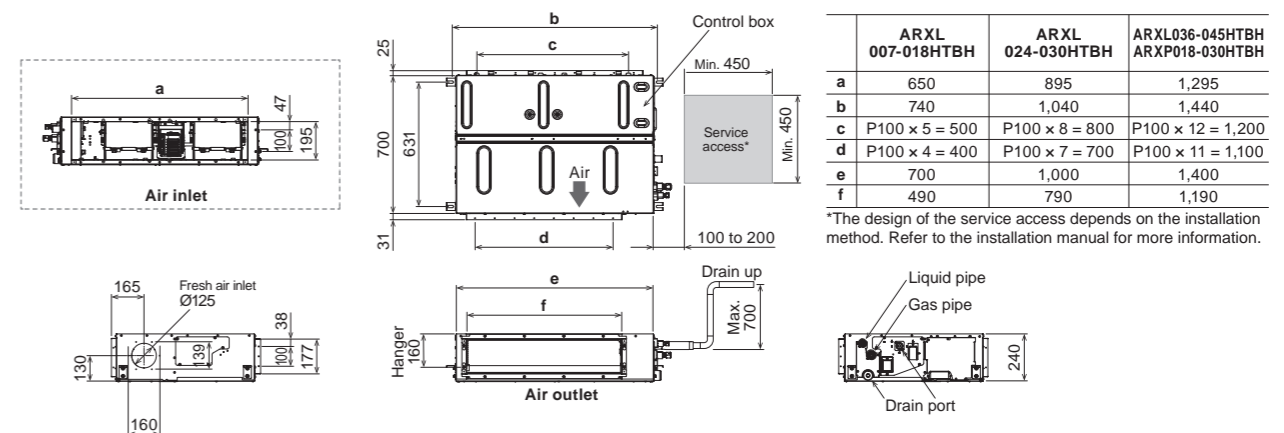

# High Static Pressure Duct

(Built-in gas sensor)



## Static Pressure Mode Selection

The use of a DC fan motor makes it possible to adjust the static pressure between 0 to 200 Pa (036) / 260Pa (045/060)



## Easy Installation (Compact & Lightweight)

The indoor unit is designed to be compact and light by reducing the basic chassis size and the overall material weight.

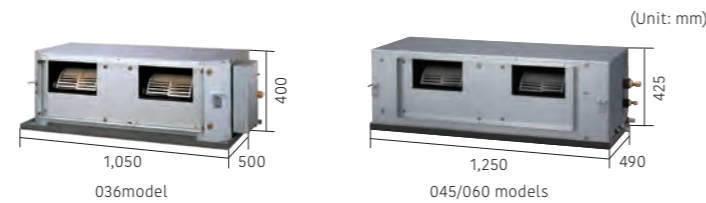

## Automatic Airflow Adjustment Function

This unique and innovative function detects required air flow in each application case and automatically adjust the volume.



## Safety measures in Case of Refrigerant Leak

Indoor units compatible with R32 refrigerant are equipped with a refrigerant leak detector. Countermeasures for issues caused by refrigerant inside the room are possible.\*



\*It is necessary to connect the required products according to the floor area of the space requirement and the amount of system refrigerant. For details, please refer to the Design and Technical Manual.

## High-Efficiency DC Fan Motor Achieves Low Energy Consumption

Improved motor efficiency compared to the previous model.



## Model: ARXC036HTBH / ARXC045HTBH / ARXC060HTBH

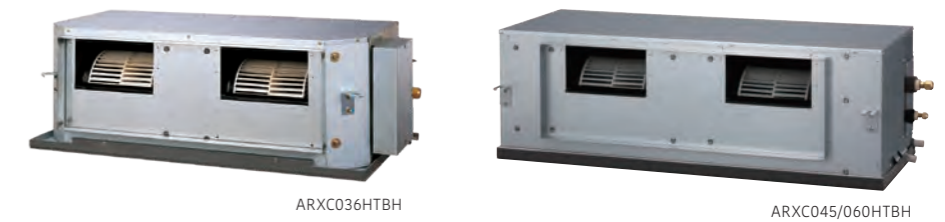

## Specifications

Model name	ARXC036HTBH		ARXC045HTBH	ARXC060HTBH
Power source	Single phase, 220-240V, 50Hz			
Capacity	Cooling	kW	11.2	12.5
	Heating	kW	12.5	14.0
Input power	W		207	297
Airflow rate	High	m <sup>3</sup> /h	1,990	2,700
	Med	m <sup>3</sup> /h	1,680	2,300
	Low	m <sup>3</sup> /h	1,330	1,890
Static pressure range	Pa		0 to 200	0 to 260
Standard static pressure	Pa		100	100
Sound pressure level	High	dB(A)	42	43
	Med	dB(A)	36	39
	Low	dB(A)	32	35
Net Dimensions (H x W x D)	mm		400x1,050x500	425x1,250x490
Weight	kg		40.0	53.0
Connection pipe diameter	Liquid	mm	9.52	9.52
	Gas	mm	15.88 (Flare)	15.88 (Flare)
Drain Hose Diameter (I.D./O.D.)	mm		25/32	25/32

Note: Specifications are based on the following conditions:  
Cooling: Indoor temperature of 27°CDB/19°CWB, and outdoor temperature of 35°CDB/24°CWB.  
Heating: Indoor temperature of 20°CDB/(15°CWB), and outdoor temperature of 7°CDB/6°CWB.  
Pipe length: 7.5 m; Height difference between outdoor unit and indoor unit: 0 m. Voltage: 230 [V]

## Optional parts

\*For more details, please refer to the chapter "Control System List" and "Optional Parts List."

Long-life filter: UTD-LF60KA (036)	External power supply unit: UTP-GXXD	Silver Ion Filter: UTD-HFKB (036/045/060)
Remote sensor unit: UTY-XSZXZ1	Shut off valve kit: UTP-GX027A, UTP-GX060A, UTP-GX090A	Gas Sensor kit: UTY-SGZH, UTY-SGZH21
Expansion kit: UTY-JXXA		

## Dimensions

(Unit: mm)

### Models: ARXC036HTBH

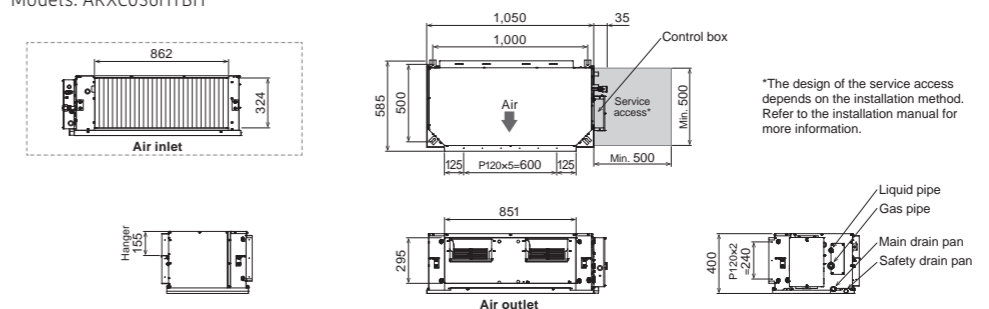

### Models: ARXC045/060HTBH

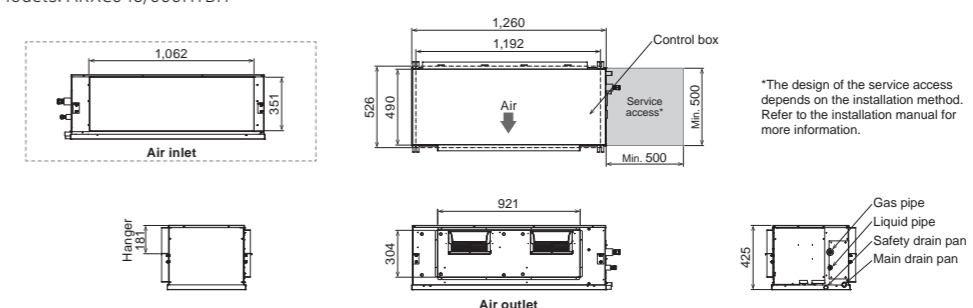

# High Static Pressure Duct

(Built-in gas sensor)



## Static Pressure Mode Selection

The use of a DC fan motor makes it possible to adjust the static pressure between 0 to 300 Pa.



## Easy Installation (Compact & Lightweight)

The indoor unit is designed to be compact and light by reducing the basic chassis size and the overall material weight.

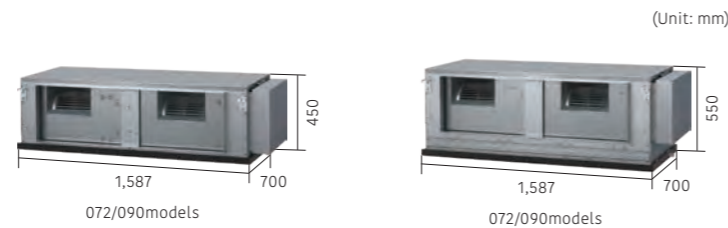

## Automatic Airflow Adjustment Function

This unique and innovative function detects required air flow in each application case and automatically adjust the volume.



## Safety measures in Case of Refrigerant Leak

Indoor units compatible with R32 refrigerant are equipped with a refrigerant leak detector. Countermeasures for issues caused by refrigerant inside the room are possible.\*



\*It is necessary to connect the required products according to the floor area of the space requirement and the amount of system refrigerant. For details, please refer to the Design and Technical Manual.

## High-Efficiency DC Fan Motor Achieves Low Energy Consumption

Improved motor efficiency compared to the previous model.



Model: ARXC072HTBH / ARXC090HTBH / ARXC096HTBH



ARXC072/090HTBH



ARXC096HTBH

## Specifications

Model name		ARXC072HTBH	ARXC090HTBH	ARXC096HTBH
Power source		Single phase, 220-240V~, 50Hz		
Capacity	Cooling	22.4	25.0	28.0
	Heating	25.0	28.0	31.5
Input power		688	1,017	924
Airflow rate	High	3,960	4,580	4,950
	Med	3,500	4,000	4,350
	Low	3,000	3,500	3,600
Static pressure range		0 to 300	0 to 300	0 to 300
Standard static pressure		150	150	150
Sound pressure level	High	47	50	49
	Med	44	45	46
	Low	40	44	42
Net Dimensions (H × W × D)		450×1,587×700	450×1,587×700	550×1,587×700
Weight		84.0	84.0	105.0
Connection pipe diameter	Liquid	9.52	9.52	9.52
	Gas	19.05 (Flare)	19.05 (Flare)	22.22 (Flare)
Drain Hose Diameter (I.D./O.D.)		25/32		

Note: Specifications are based on the following conditions:  
 Cooling: Indoor temperature of 27°CDB/19°CWB, and outdoor temperature of 35°CDB/24°CWB.  
 Heating: Indoor temperature of 20°CDB/(15°CWB), and outdoor temperature of 7°CDB/6°CWB.  
 Pipe length: 7.5 m; Height difference between outdoor unit and indoor unit: 0 m. Voltage: 230 [V]

## Optional parts

\*For more details, please refer to the chapter "Control System List" and "Optional Parts List."

Remote sensor kit: UTY-XSZXZ1  
 Expansion kit: UTZ-JXXA

Gas Sensor kit: UTY-SGZH, UTY-SGZH21  
 External Power Supply Unit: UTZ-GXXD

Shut off valve kit: UTP-GX027A / UTP-GX060A / UTP-GX090A

## Dimensions

(Unit: mm)

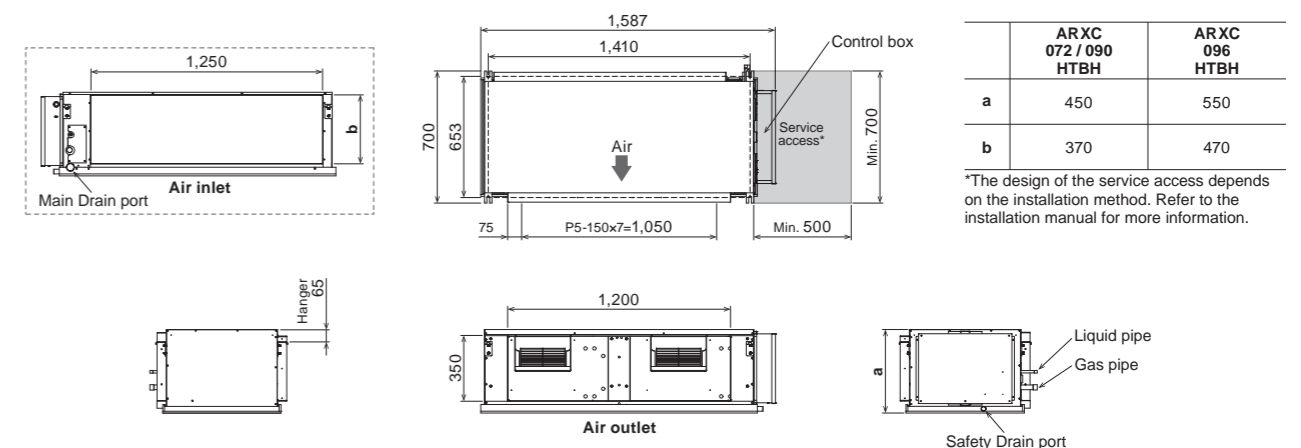

	ARXC 072 / 090 HTBH	ARXC 096 HTBH
a	450	550
b	370	470

\*The design of the service access depends on the installation method. Refer to the installation manual for more information.

# Floor

EEV internal / EEV external  
(Built-in gas sensor)



**Model: [EEV Internal]**  
AGHA007HCBH / AGHA009HCBH  
AGHA012HCBH / AGHA014HCBH

**[EEV External]**  
AGHE007HCBH / AGHE009HCBH  
AGHE012HCBH / AGHE014HCBH

### Specifications

Model name		AGHA007HCBH	AGHA009HCBH	AGHA012HCBH	AGHA014HCBH	AGHE007HCBH	AGHE009HCBH	AGHE012HCBH	AGHE014HCBH
Power source		Single phase, 220-240V, 50Hz				Single phase, 220-240V, 50Hz			
Capacity	Cooling	2.2	2.8	3.6	4.0	2.2	2.8	3.6	4.0
	Heating	2.8	3.2	4.0	4.5	2.8	3.2	4.0	4.5
Input power		16	17	22	29	16	17	22	29
Airflow rate	High	470	500	590	670	470	500	590	670
	Med-High	420	450	520	590	420	450	520	590
	Med	390	400	470	520	390	400	470	520
	Med-Low	360	360	420	450	360	360	420	450
	Low	330	330	390	390	330	330	390	390
Sound pressure level	High	37	38	42	46	37	38	42	46
	Med-High	35	36	39	42	35	36	39	42
	Med	33	34	37	39	33	34	37	39
	Med-Low	31	31	35	36	31	31	35	36
	Low	29	29	33	33	29	29	33	33
Quiet	22	22	30	30	22	22	30	30	
Net Dimensions (H × W × D)		600×740×200				600×740×200			
Weight		15.0	15.0	15.0	15.0	14.5	14.5	14.5	14.5
Connection pipe diameter	Liquid (Flare)	6.35	6.35	6.35	6.35	6.35	6.35	6.35	6.35
	Gas (Flare)	9.52	9.52	12.7	12.7	9.52	9.52	12.7	12.7
Drain Hose Diameter (I.D./O.D.)		13.8/15.8 to16.7				13.8/15.8 to16.7			
EV kit (optional)						UTR-EV09XC		UTR-EV14XC	

Note: Specifications are subject to the following conditions:  
Cooling: Indoor temperature of 27°CDB/19°CWB, and outdoor temperature of 35°CDB/24°CWB.  
Heating: Indoor temperature of 20°CDB/(15°CWB), and outdoor temperature of 7°CDB/6°CWB.  
Pipe length: 7.5 m; Height difference between outdoor unit and indoor unit: 0 m. Voltage: 230 [V]

### 2-Fan and Wide Airflow

A 2-fan individual vertical airflow cools or warms the entire room comfortably.

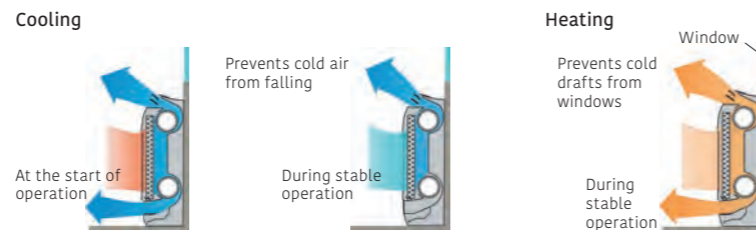

### Flexible and Easy Installation

The compact and whole-surface suction design provides flexible installation options, including floor-standing, embedded, partially embedded, and wall-mounted installation to match the room layout.

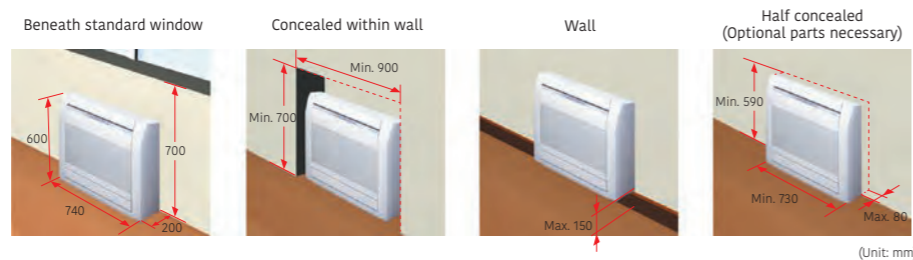

### Quiet Operation

6-fan speed control for quiet operation (via 2-wire controller)

Low noise  
**22 dB(A)**

007/009 models

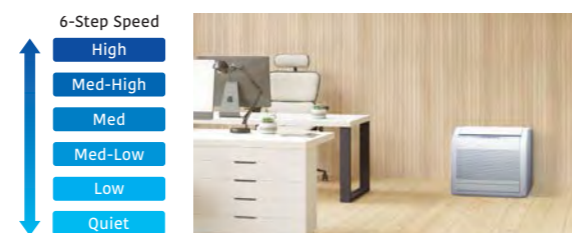

\* Remote controller is compatible with the following:  
UTY-RVRG / UTY-RNRGZ6 / UTY-RLRG / UTY-RSRGZ1 / UTY-RHRGZ1 / UTY-DCGGZ4 / UTY-ALGXZ1 / UTY-APGXZ1

### Safety measures in Case of Refrigerant Leak

Indoor units compatible with R32 refrigerant are equipped with a refrigerant leak detector. Countermeasures for issues caused by refrigerant inside the room are possible.\*

\*It is necessary to connect the required products according to the floor area of the space requirement and the amount of system refrigerant. For details, please refer to the Design and Technical Manual.



### Optional parts

\*For more details, please refer to the chapter "Control System List" and "Optional Parts List."

Partially concealing kit: UTR-STA	External power supply unit: UTZ-GXXD	Expansion kit: UTZ-JXXA
External power supply unit: UTZ-GXXD	Remote sensor unit: UTY-XSZXZ1	EV kit: UTR-EV09XC (007-009), UTR-EV14XC (012-014) (For EEV external model)
Silver Ion Filter: UTR-FA03-5	Shut off valve kit: UTP-GX027A, UTP-GX060A, UTP-GX090A	
Gas Sensor kit: UTY-SGZH, UTY-SGZHZ1		

### Dimensions

(Unit: mm)

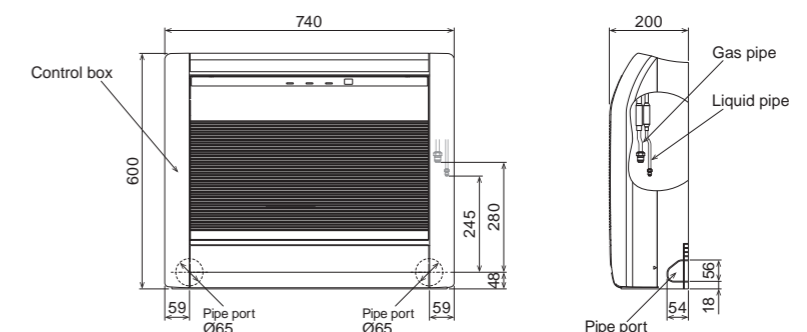

# Ceiling

(Built-in gas sensor)



## Light Elegant Design

The light-elegant, gently curved surface gives a sense of comfort and well-being.



## Easy Installation

The indoor unit can be easily installed under the ceiling thanks to the uniquely designed mounting kit.

1. Set mounting brackets

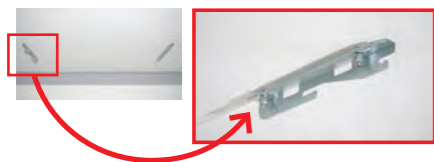

2. Hold up the ceiling unit and fit to the mounting brackets



3. Attach with screws



## Easy Maintenance

The front panel can be opened without removing it for safe & speedy maintenance.



The drain pan can be removed for cleaning.



Components in the control box can be easily accessed from the wide side opening.

## Safety measures in Case of Refrigerant Leak

Indoor units compatible with R32 refrigerant are equipped with a refrigerant leak detector. Countermeasures for issues caused by refrigerant inside the room are possible.\*



\*It is necessary to connect the required products according to the floor area of the space requirement and the amount of system refrigerant. For details, please refer to the Design and Technical Manual.

## Flexible Installation

The drain hose and pipe can be contained in the casing and connected in the right, left, angled, or downward direction.



Model: ABHA012HTBH / ABHA014HTBH / ABHA018HTBH  
 ABHA024HTBH / ABHA030HTBH / ABHA036HTBH  
 ABHA045HTBH / ABHA054HTBH



ABHA012/014/018HTBH



ABHA024/030HTBH



ABHA036/045/054HTBH

## Specifications

Model name		ABHA012HTBH	ABHA014HTBH	ABHA018HTBH	ABHA024HTBH	ABHA030HTBH	ABHA036HTBH	ABHA045HTBH	ABHA054HTBH
Power source		Single phase, 220-240V, 50Hz							
Capacity	Cooling	3.6	4.5	5.6	7.1	9.0	11.2	12.5	14.0
	Heating	4.0	5.0	6.3	8.0	10.0	12.5	14.0	16.0
Input power		32	32	61	65	117	142	174	210
Airflow rate	High	780	780	990	1,350	1,660	2,100	2,280	2,400
	Med-High	750	750	920	1,220	1,470	1,910	2,040	2,120
	Med	730	730	850	1,100	1,280	1,690	1,800	1,870
	Med-Low	700	700	780	970	1,080	1,480	1,570	1,630
	Low	680	680	710	860	890	1,300	1,310	1,420
Sound pressure level	Quiet	650	650	650	700	700	1,050	1,050	1,220
	High	36	36	42	42	49	48	50	52
	Med-High	35	35	40	40	46	45	47	49
	Med	35	35	38	38	42	43	44	47
	Med-Low	34	34	36	35	38	40	41	44
Low	33	33	33	32	32	37	37	41	
Quiet	31	31	31	29	29	32	32	38	
Net Dimensions (H × W × D)		mm 235×1,080×705			mm 235×1,390×705		mm 235×1,700×705		
Weight		kg 25.0	kg 25.0	kg 25.0	kg 32.0	kg 32.0	kg 39.0	kg 39.0	kg 42.0
Connection pipe diameter	Liquid (Flare)	6.35	6.35	6.35	9.52	9.52	9.52	9.52	9.52
	Gas (Flare)	12.7	12.7	12.7	15.88	15.88	15.88	15.88	15.88
Drain Hose Diameter (I.D./O.D.)		25/32							

Note: Specifications are subject to the following conditions:  
 Cooling: Indoor temperature of 27°CDB/19°CWB, and outdoor temperature of 35°CDB/24°CWB.  
 Heating: Indoor temperature of 20°CDB/(15°CWB), and outdoor temperature of 7°CDB/6°CWB.  
 Pipe length: 7.5 m; Height difference between outdoor unit and indoor unit: 0 m. Voltage: 230 [V]

## Optional parts

\*For more details, please refer to the chapter "Control System List" and "Optional Parts List."

External power supply unit: UTZ-GXXD  
 Remote sensor unit: UTY-XS2XZ1  
 L-type piping kit: UTP-FX24A/UTP-FX35A

Shut off valve kit: UTP-GX027A, UTP-GX060A, UTP-GX090A  
 Gas Sensor kit: UTY-SGZH, UTY-SGZH21

Expansion kit: UTZ-JXXA  
 Drain pump unit: UTR-DPB24T

## Dimensions

(Unit: mm)

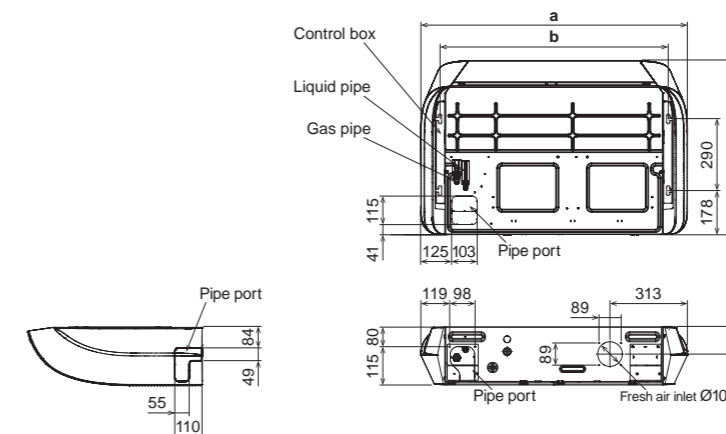

	ABHA 012/014/018 HTBH	ABHA 024/030 HTBH	ABHA 036/045/054 HTBH
a	1,080	1,390	1,700
b	923	1,233	1,543

# Wall-Mounted

EEV internal / EEV external  
(Built-in gas sensor)



**Model: [EEV Internal]**  
 ASHA004HTBH / ASHA005HTBH / ASHA007HTBH  
 ASHA009HTBH / ASHA012HTBH / ASHA014HTBH  
 ASHA018HTBH

**[EEV External]**  
 ASHE004HTBH / ASHE005HTBH / ASHE007HTBH  
 ASHE009HTBH / ASHE012HTBH / ASHE014HTBH  
 ASHE018HTBH

### Specifications

Model name	ASHA 004 HTBH	ASHA 005 HTBH	ASHA 007 HTBH	ASHA 009 HTBH	ASHA 012 HTBH	ASHA 014 HTBH	ASHA 018 HTBH	ASHE 004 HTBH	ASHE 005 HTBH	ASHE 007 HTBH	ASHE 009 HTBH	ASHE 012 HTBH	ASHE 014 HTBH	ASHE 018 HTBH	
Power source	Single phase, 220-240V, 50Hz							Single phase, 220-240V, 50Hz							
Capacity	Cooling	1.1	1.7	2.2	2.8	3.6	4.0	5.6	1.1	1.7	2.2	2.8	3.6	4.0	5.6
	Heating	1.3	1.9	2.8	3.2	4.0	4.5	6.3	1.3	1.9	2.8	3.2	4.0	4.5	6.3
Input power	W							W							
Airflow rate	High	490	490	490	490	640	740	930	490	490	490	490	640	740	930
	Med-High	460	460	460	460	590	680	840	460	460	460	460	590	680	840
	Med	430	430	430	430	530	590	730	430	430	430	430	530	590	730
	Med-Low	400	400	400	400	460	500	610	400	400	400	400	460	500	610
	Low	370	370	370	370	390	410	500	370	370	370	370	390	410	500
Quiet	330	330	330	330	330	330	380	330	330	330	330	330	330	380	
Sound pressure level	High	33	33	33	33	40	44	49	33	33	33	33	40	44	49
	Med-High	32	32	32	31	38	42	47	32	32	32	31	38	42	47
	Med	31	31	31	29	35	38	43	31	31	31	29	35	38	43
	Med-Low	30	30	30	28	31	34	39	30	30	30	28	31	34	39
	Low	29	29	29	27	28	28	33	29	29	29	27	28	28	33
Quiet	24	24	24	22	22	22	27	24	24	24	22	22	22	27	
Net Dimensions (H × W × D)	mm							mm							
Weight	kg							kg							
Connection pipe diameter	Liquid (Flare)	6.35	6.35	6.35	6.35	6.35	6.35	6.35	6.35	6.35	6.35	6.35	6.35	6.35	6.35
	Gas (Flare)	9.52	9.52	9.52	9.52	12.7	12.7	12.7	9.52	9.52	9.52	9.52	12.7	12.7	12.7
Drain Hose Diameter (I.D./O.D.)	mm							mm							
EV kit (optional)	-							UTR-EV09XC			UTR-EV14XC				

### More Comfortable Airflow

The unique power diffuser provides comfortable air conditioning.

#### Heating

The vertical airflow provides powerful floor-level heating.



#### Cooling

The left/right airflow avoids blowing cool air directly at the occupants in a room.



### Quiet Operation & 6-Step Fan Speed Control

The airflow pattern achieves significant noise reduction. Multistep airflow adjustment to suit the environment

Quiet mode  
**22 dB(A)**

009/012/014 models

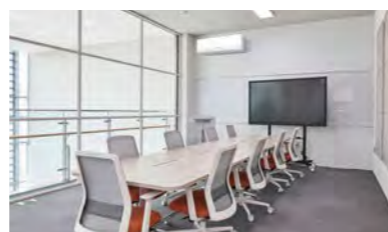
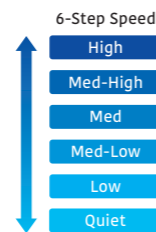

\* Remote controller is compatible with the following:  
 UTY-RVRG / UTY-RNRGZ6 / UTY-RLRG / UTY-RSRGZ1 / UTY-RHRGZ1 / UTY-DCGGZ4 / UTY-ALGXZ1 / UTY-APGXZ1

### The Occupancy Sensor Contributes to Further Energy Savings.

Energy saving operation starts automatically by detecting the motion of a person. Two modes of save operation mode and stop mode can be selected.

\* UTY-RNRGZ6 / UTY-DCGGZ4 / UTY-RVRG only

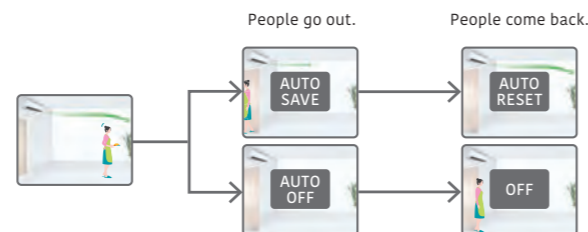

### Safety measures in Case of Refrigerant Leak

Indoor units compatible with R32 refrigerant are equipped with a refrigerant leak detector. Countermeasures for issues caused by refrigerant inside the room are possible.\*



\*It is necessary to connect the required products according to the floor area of the space requirement and the amount of system refrigerant. For details, please refer to the Design and Technical Manual.

### Slim & Stylish Square Design

The slim and stylish square design of this indoor unit is realized by using a high-density, multipath heat exchanger and a high-efficiency wind blower.

W 834 mm

H 270 mm  
D 239 mm



### Optional parts

\*For more details, please refer to the chapter "Control System List" and "Optional Parts List."

External power supply unit: UTP-GXXD  
 EV kit: UTR-EV09XC (004-009), UTR-EV14XC (012-018) (For EEV external model)

Shut off valve kit: UTP-GX027A, UTP-GX060A, UTP-GX090A  
 Gas Sensor kit: UTY-SGZH, UTY-SGZH21

Expansion kit: UTP-JXXA  
 Silver Ion Filter: UTR-FA16-5  
 Remote sensor unit: UTY-XSZXZ1

### Dimensions

(Unit: mm)

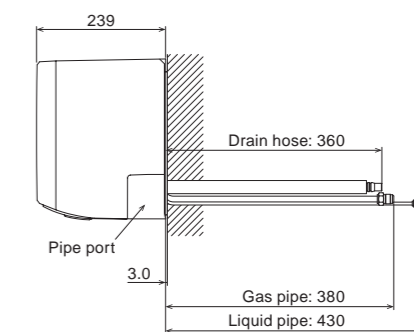
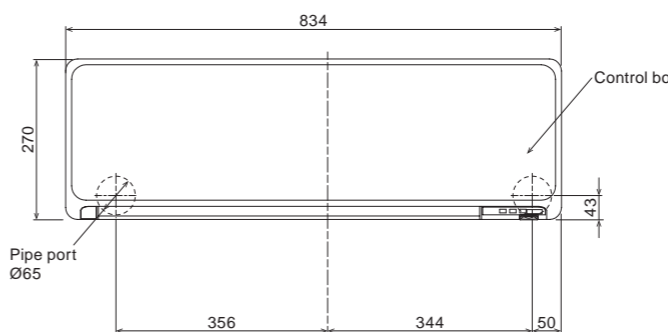

# Wall-Mounted

(Built-in gas sensor)

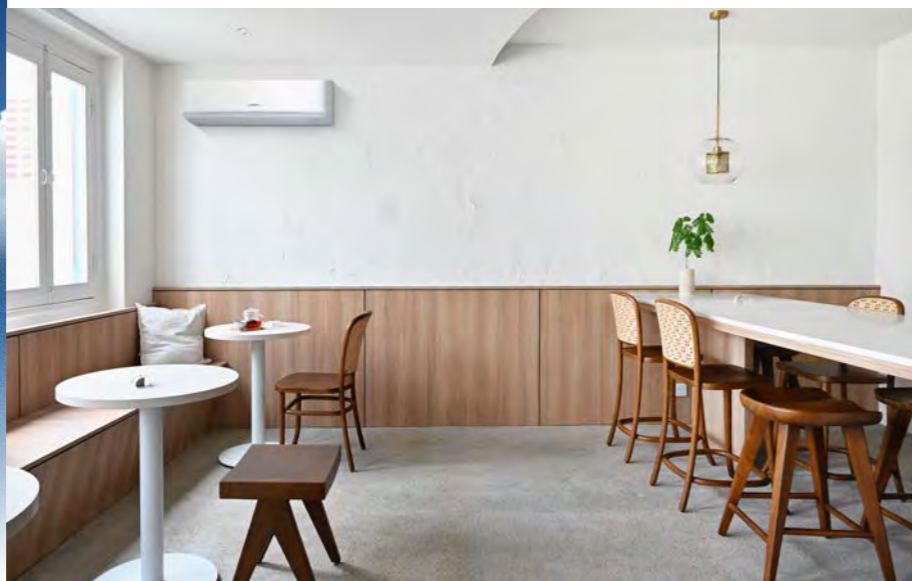

## Powerful & Comfort Airflow

### Powerful Airflow

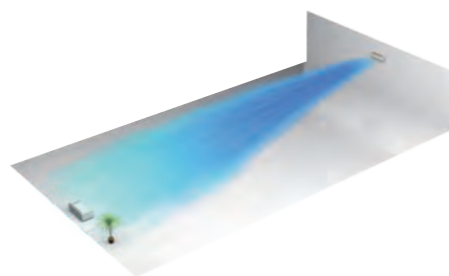

## 6-Step Fan Speed Control for Quiet Operation

The airflow pattern achieves significant noise reduction. A 6-step sound level setting allows for multiple-step quiet operations.



\* Remote controller is compatible with the following:  
 UTY-RVRG / UTY-RNRGZ6 / UTY-RLRG / UTY-RSRGZ1 / UTY-RHRGZ1 / UTY-DCGGZ6 / UTY-ALGXZ1 / UTY-APGXZ1

## The Occupancy Sensor Contributes to Further Energy Savings.

Energy saving operation starts automatically by detecting the motion of a person. Two modes of save operation mode and stop mode can be selected.

\* UTY-RNRGZ6 / UTY-DCGGZ4 / UTY-RVRG only

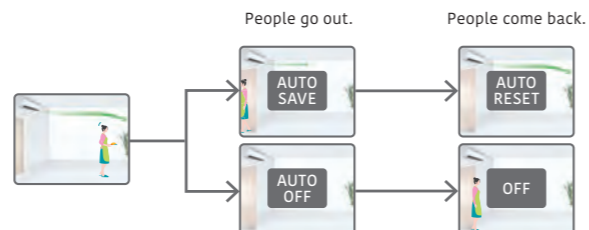

## Safety measures in Case of Refrigerant Leak

Indoor units compatible with R32 refrigerant are equipped with a refrigerant leak detector. Countermeasures for issues caused by refrigerant inside the room are possible.\*

\*It is necessary to connect the required products according to the floor area of the space requirement and the amount of system refrigerant. For details, please refer to the Design and Technical Manual.



Model: ASHB018HTBH / ASHB024HTBH  
 ASHB030HTBH / ASHB034HTBH



## Specifications

Model name		ASHB018HTBH	ASHB024HTBH	ASHB030HTBH	ASHB034HTBH
Power source		Single phase, 220-240V, 50Hz			
Capacity	Cooling	5.6	7.1	9.0	10.0
	Heating	6.3	8.0	10.0	11.2
Input power		27	38	82	104
Airflow rate	High	890	1,050	1,440	1,620 / 1,520*
	Med-High	850	970	1,200	1,300
	Med	820	910	1,050	1,120
	Med-Low	780	840	940	980
	Low	740	770	890	890
	Quiet	700	700	700	700
Sound pressure level	High	39	44	53	55 / 54*
	Med-High	38	42	49	51
	Med	37	40	45	47
	Med-Low	36	38	42	43
	Low	34	35	39	39
	Quiet	33	33	33	33
Net Dimensions (H x W x D)		mm 340x1,150x280	340x1,150x280	340x1,150x280	340x1,150x280
Weight		kg 18.0	18.0	18.0	18.0
Connection pipe diameter	Liquid (Flare)	6.35	9.52	9.52	9.52
	Gas (Flare)	12.7	15.88	15.88	15.88
Drain Hose Diameter (I.D./O.D.)		13.8/15.8 to16.7			

Note: Specifications are subject to the following conditions:  
 Cooling: Indoor temperature of 27°CDB/19°CWB, and outdoor temperature of 35°CDB/24°CWB.  
 Heating: Indoor temperature of 20°CDB/(15°CWB), and outdoor temperature of 7°CDB/6°CWB.  
 Pipe length: 7.5 m; Height difference between outdoor unit and indoor unit: 0 m. Voltage: 230 [V].

## Optional parts

\*For more details, please refer to the chapter "Control System List" and "Optional Parts List."

External power supply unit: UTY-GXXD  
 Silver Ion Filter: UTR-FA13-3  
 Remote sensor unit: UTY-XSZXZ1  
 Shut off valve kit: UTP-GX027A, UTP-GX060A, UTP-GX090A  
 Expansion kit: UTY-JXXA  
 Gas Sensor kit: UTY-SGZH, UTY-SGZH1

## Dimensions

(Unit: mm)

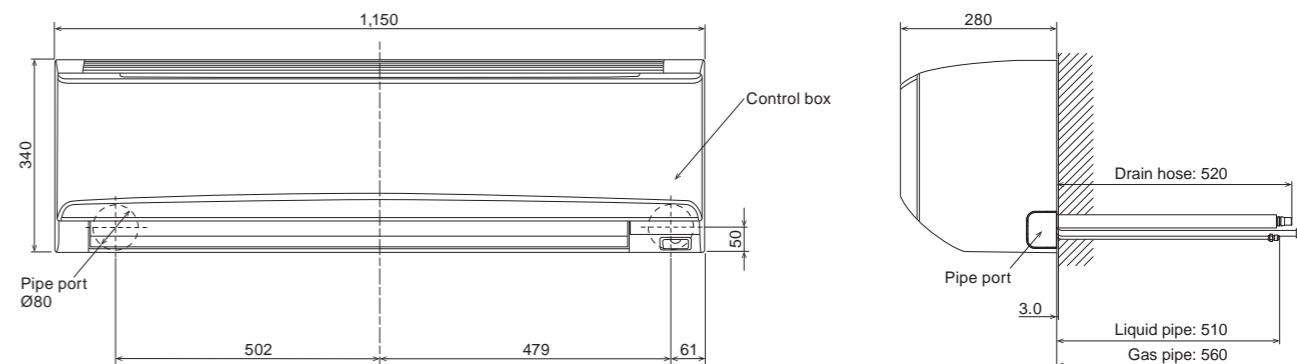

# Wall-Mounted

EEV internal / EEV external



## Highly-Efficiency, Compact Design

The high-density and large heat exchanger achieves a highly-efficiency and compact design. The compact body blends in well with conference rooms and offices, providing comfortable air conditioning.

### High-density heat exchanger



**Slim tube design: 5 mm**  
Greater heat-exchanging capacity is achieved through the use of a high-density heat exchanger and a sub-heat exchanger.

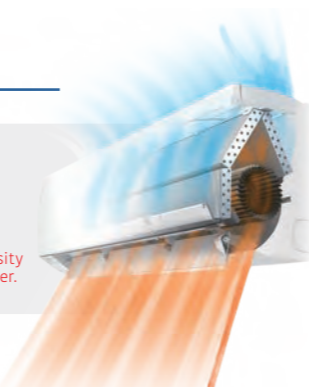

## More Comfortable Airflow

The unique power diffuser provides comfortable air conditioning.

### Heating

The vertical airflow provides powerful floor-level heating.



### Cooling

The left/right airflow avoids blowing cool air directly at the occupants in a room.



## Quiet Operation & 6-Step Fan Speed Control

The airflow pattern achieves significant noise reduction. Multistep airflow adjustment to suit the environment

Quiet mode  
**22 dB(A)**

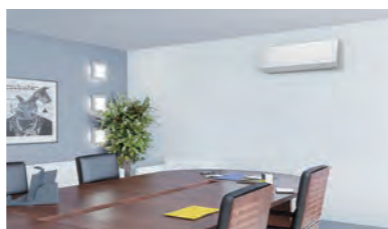
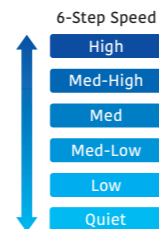

\* Remote controller is compatible with the following:  
UTY-RVRG / UTY-LNVG / UTY-RNRG26 / UTY-RLRG / UTY-RSRG21 / UTY-RHRG21 / UTY-DCGG24 / UTY-ALGX21 / UTY-APGX21

## The Occupancy Sensor Contributes to Further Energy Savings.

Energy saving operation starts automatically by detecting the motion of a person. Two modes of save operation mode and stop mode can be selected.

\* If you want to use the Occupancy sensor control function, you need an setting device that can set the Occupancy sensor control function. For example: Wired RC (Touch panel).

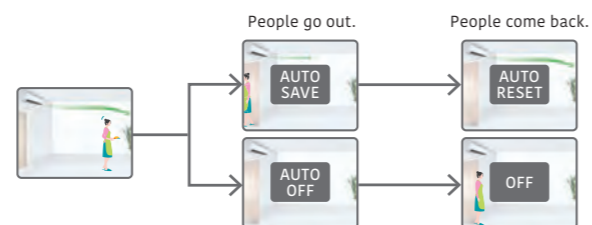

**Model: [EEV Internal]**  
ASHA004HCAH / ASHA005HCAH / ASHA007HCAH  
ASHA009HCAH / ASHA012HCAH / ASHA014HCAH

**[EEV External]**  
ASHE004HCAH / ASHE005HCAH / ASHE007HCAH  
ASHE009HCAH / ASHE012HCAH / ASHE014HCAH



## Specifications

Model name		ASHA004HCAH	ASHA005HCAH	ASHA007HCAH	ASHA009HCAH	ASHA012HCAH	ASHA014HCAH	ASHE004HCAH	ASHE005HCAH	ASHE007HCAH	ASHE009HCAH	ASHE012HCAH	ASHE014HCAH
Power source		Single phase, 220-240V~, 50Hz						Single phase, 220-240V~, 50Hz					
Capacity	Cooling	1.1	1.7	2.2	2.8	3.6	4.0	1.1	1.7	2.2	2.8	3.6	4.0
	Heating	1.3	1.9	2.8	3.2	4.0	4.5	1.3	1.9	2.8	3.2	4.0	4.5
Input power		12	12	16	19	25	35	12	12	16	19	25	35
Airflow rate	High	450	450	550	590	660	770	450	450	550	590	660	770
	Med-High	430	430	490	550	590	710	430	430	490	550	590	710
	Med	400	400	450	490	550	650	400	400	450	490	550	650
	Med-Low	380	380	390	420	510	590	380	380	390	420	510	590
	Low	360	360	360	360	450	530	360	360	360	360	450	530
Sound pressure level	Quiet	310	310	320	320	320	320	310	310	320	320	320	320
	High	31	31	34	37	40	44	31	31	34	37	40	44
	Med-High	30	30	32	34	37	42	30	30	32	34	37	42
	Med	28	28	30	32	34	40	28	28	30	32	34	40
	Med-Low	27	27	28	29	33	37	27	27	28	29	33	37
Low	26	26	26	26	30	34	26	26	26	26	30	34	
Quiet	22	22	22	22	22	22	22	22	22	22	22	22	
Net Dimensions (H × W × D)		mm 268 × 840 × 203						mm 268 × 840 × 203					
Weight		kg 8						kg 8					
Connection pipe diameter	Liquid (Flare)	6.35	6.35	6.35	6.35	6.35	6.35	6.35	6.35	6.35	6.35	6.35	6.35
	Gas (Flare)	9.52	9.52	9.52	9.52	12.70	12.70	9.52	9.52	9.52	9.52	12.70	12.70
Drain Hose Diameter (I.D./O.D.)		13.8/15.8 to16.7						13.8/15.8 to16.7					
EV Kit (optional)		-						UTR-EV09XC			UTR-EV14XC		

Note: Specifications are subject to the following conditions:  
Cooling: Indoor temperature of 27°CDB/19°CWB, and outdoor temperature of 35°CDB/24°CWB.  
Heating: Indoor temperature of 20°CDB/(15°CWB), and outdoor temperature of 7°CDB/6°CWB.  
Pipe length: 7.5 m; Height difference between outdoor unit and indoor unit: 0 m. Voltage: 230 [V]

## Optional parts

\*For more details, please refer to the chapter "Control System List" and "Optional Parts List."

External power supply unit: UTZ-GXXD  
EV kit: UTR-EV09XC (004-009), UTR-EV14XC (012,014)

Expansion Kit: UTZ-JXXA  
Remote Sensor Kit: UTY-XSZXZ1  
Silver Ion Filter: UTR-FA16-5

Gas Sensor Kit: UTY-SGZH / UTY-SGZH21  
Shut off valve kit: UTP-GX027A / UTP-GX060A / UTP-GX090A

## Dimensions

(Unit: mm)

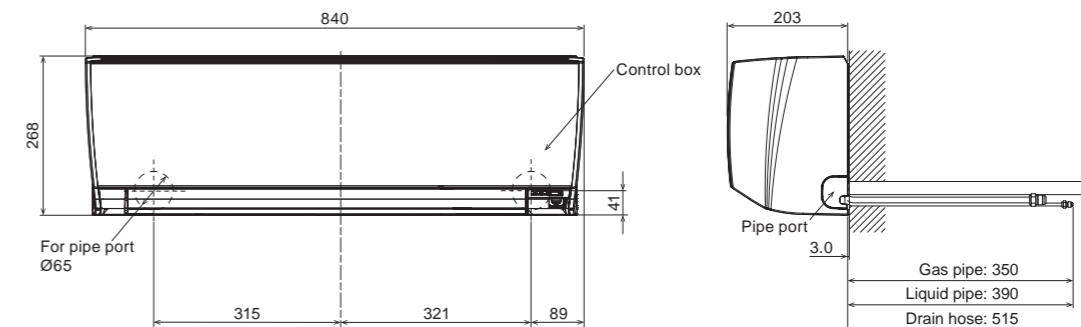



# VRF R410A OUTDOOR UNITS

The R410A VRF outdoor units feature a lineup of 5 types and 80 models to meet all architectural design requirements.

We offer a wide range of outdoor units suitable for every application, from small-scale properties like apartments to large-scale commercial facilities and buildings.

V-068 VRF R410A Outdoor Units Lineup for J-IVS, J-IV, J-IVL, VR-IV, V-IV

V-070 VRF J-IVS

V-074 VRF J-IV

V-078 VRF J-IVL

V-084 VRF VR-IV

V-094 VRF V-IV



# VRF R410A Outdoor Units Lineup

## for J-IVS J-IV J-IVL VR-IV V-IV

Capacity (kW)		12.1	14.0	15.1-15.5	22.4	28.0	33.5	40.0	45.0	50.0-50.4	55.9	61.5	67.0	73.5	78.5	85.0	90.0	95.0	100.5	107.0	112.0	118.5	123.5	130.0	135.0	
HP		4	5	6	8	10	12	14	16	18	20	22	24	26	28	30	32	34	36	38	40	42	44	46	48	
<b>J-IVS series Heat Pump</b>																										
		AJH040 LCLDH	AJH045 LCLDH	AJH054 LCLDH																						
<b>J-IV series Heat Pump</b>																										
		AJH040 LBLDH, AJH040 LELDH	AJH045 LBLDH, AJH045 LELDH	AJH054 LBLDH, AJH054 LELDH																						
<b>J-IVL series Heat Pump</b>																										
					AJH072 LELDH	AJH090 LELDH	AJH108 LELDH	AJH126 LELDH	AJH144 LELDH	AJH162 LELDH																
<b>VR-IV series Heat Recovery</b>	Space Saving																									
	Set Model				AJH072 GALDH	AJH090 GALDH	AJH108 GALDH	AJH126 GALDH	AJH144 GALDH	AJH162 GALDH	AJH180 GALDH	AJH198 GALDH		AJH216 GALDH	AJH234 GALDH	AJH252 GALDH	AJH270 GALDH	AJH288 GALDH	AJH306 GALDH	AJH324 GALDH	AJH342 GALDH	AJH360 GALDH	AJH378 GALDH	AJH396 GALDH	AJH414 GALDH	AJH432 GALDH
	Energy Efficiency																									
Set Model								AJH144 GALDHH			AJH198 GALDHH		AJH216 GALDHH	AJH234 GALDHH	AJH252 GALDHH	AJH270 GALDHH	AJH288 GALDHH	AJH306 GALDHH	AJH324 GALDHH	AJH342 GALDHH	AJH360 GALDHH	AJH378 GALDHH	AJH396 GALDHH			
<b>V-IV series Heat Pump</b>	Space Saving																									
	Set Model				AJH072 LALDH	AJH090 LALDH	AJH108 LALDH	AJH126 LALDH	AJH144 LALDH	AJH162 LALDH	AJH180 LALDH	AJH198 LALDH		AJH216 LALDH	AJH234 LALDH	AJH252 LALDH	AJH270 LALDH	AJH288 LALDH	AJH306 LALDH	AJH324 LALDH	AJH342 LALDH	AJH360 LALDH	AJH378 LALDH	AJH396 LALDH	AJH414 LALDH	AJH432 LALDH
	Energy Efficiency																									
Set Model								AJH144 LALDHH		AJH180 LALDHH		AJH216 LALDHH	AJH234 LALDHH	AJH252 LALDHH	AJH270 LALDHH	AJH288 LALDHH	AJH306 LALDHH	AJH324 LALDHH	AJH342 LALDHH	AJH360 LALDHH	AJH378 LALDHH	AJH396 LALDHH				



**Heat Pump**  
for Small-capacity type

VRF **J-IVS**

**System configuration example**

- Suitable for air conditioning small and medium-size buildings. One refrigerant system is used for each outdoor unit.
- Multiple indoor units are connected with separation tubes and headers.

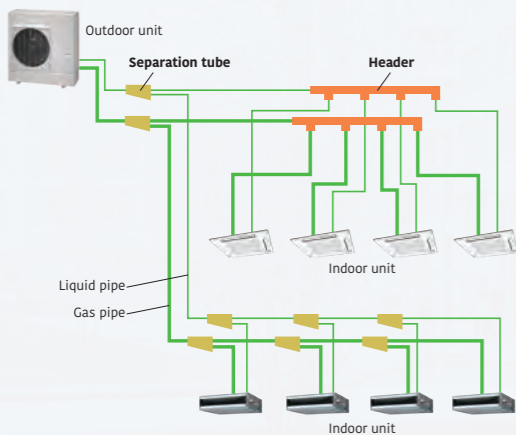

**Intelligent Refrigerant Control**

The Intelligent refrigerant control operates with suitable control corresponding to the heat load of the room and offers a more comfortable environment. The Intelligent refrigerant control can also provide increased energy savings.

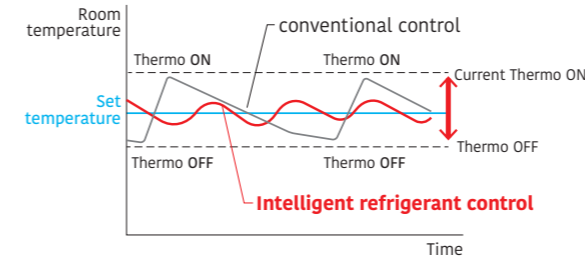

The thermostat is turned on and off less frequently than under conventional control to maintain the room temperature at the target temperature. Compared to conventional control, the compressor will run longer, thus saving energy.

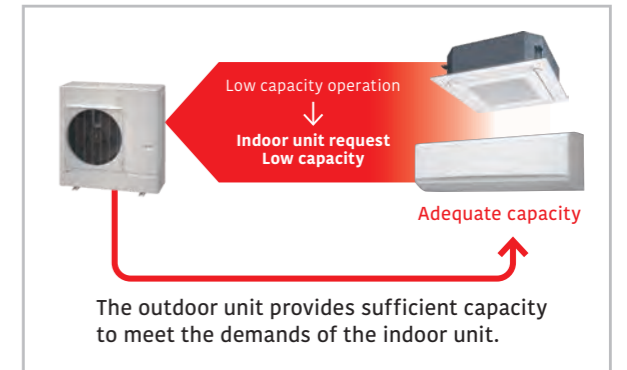

\* The improvements due to the control and the actual sine wave vary depending on the combination of the indoor unit and system operating conditions.

**External Static Pressure**

External static pressure measures up to 25 Pa for 4/5/6 HP models.



**Advanced High-Efficiency Technology**



**Large propeller fan**  
A large propeller fan with an optimized blade angle achieves both high performance and low noise operation.



**DC fan motor**  
A small, multi-stage DC fan motor provides high-efficiency and low noise operation.

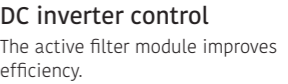

**DC inverter control**  
The active filter module improves efficiency.

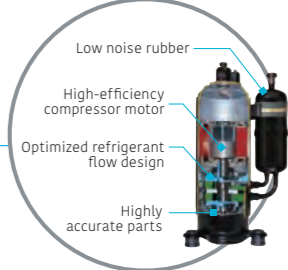

**Compact and high-performance DC twin-rotary compressor**  
High-efficiency is achieved across compressor loads. Especially good performance is achieved in the low- to medium-load range.

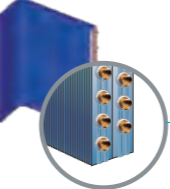

**Large heat exchanger**  
The large 3-row heat exchanger substantially improves heat-exchanging performance.



High heat-transfer copper tube (Improved lead angle)

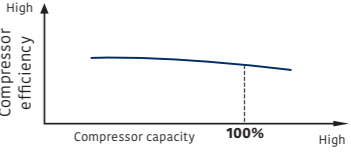

Compressor efficiency vs. Compressor capacity. The graph shows a relatively flat line for efficiency across the capacity range, with a vertical dashed line at 100% capacity.

### Easy to Carry, Easy to Install

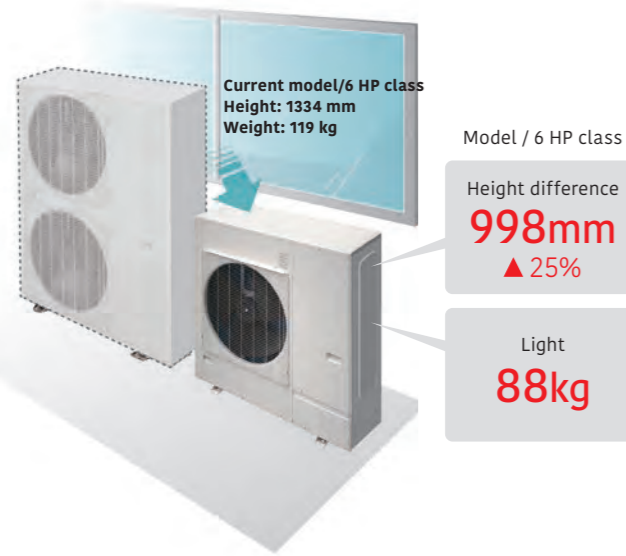

### Small, Lightweight Outdoor Unit

The outdoor units in this series are much more compact than conventional outdoor units of comparable capacity. They can be installed on a balcony, fitting below the height of the railing. With a height of less than 1 m, they can be installed in tight spaces such as under windows.

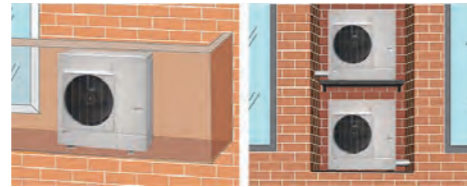

### Low Noise Design

Significantly low noise levels are achieved by the use of a DC twin-rotary compressor, inverter technology, and an advanced airflow pattern design.



### Long Pipe Length

Our advanced refrigerant control technology extends the maximum allowable length of refrigerant pipe to 80 m. This provides high flexibility in system design.

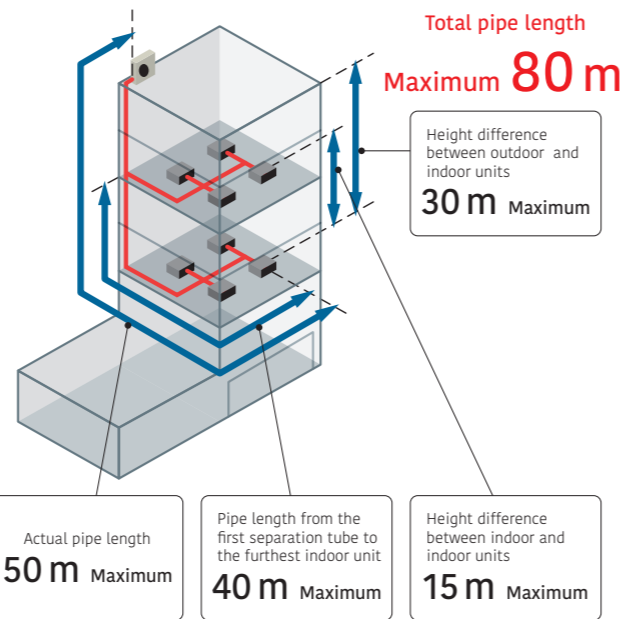

### Up to 13 Indoor Units\* can be Connected

The combination of smaller but sufficiently powerful indoor units and a outdoor unit with an optimized heat exchanging structure makes it possible to connect up to 13 indoor units, which is the best in its class.

\*: 6 HP model

Model	J-IVS		
Rating Capacity range (HP)	4	5	6
Max. Connectable indoor unit	1-11	1-12	1-13

### Non-Stop Oil Recovery Operation

A comfortable room condition is maintained during oil recovery mode because the product continues to operate without stopping the cooling or heating operation.

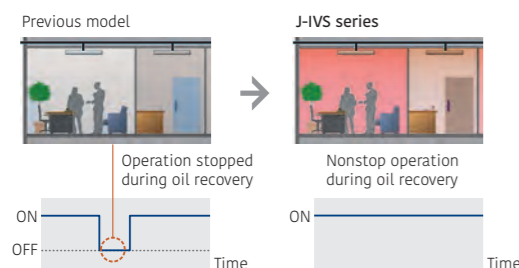

### Easier Installation

**Connection check function:** Wiring connections and address settings can be checked thanks to the quick check run function.

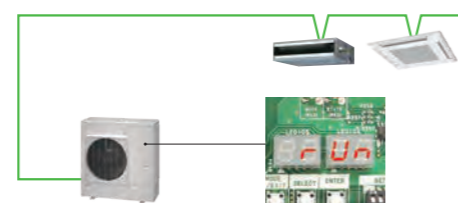

- Displays the number of each connected indoor unit.
- Displays the duplicate address number assigned to an indoor unit.

### Specifications

Rated capacity range	HP	4	5	6
Model name		AJH040LCDH	AJH045LCDH	AJH054LCDH
Maximum connectable indoor units		1-11	1-12	1-13
Power source		Single phase, 230V~, 50Hz		
Capacity	Cooling	14.0	14.0	15.1
	Nominal Heating	12.1	14.0	15.1
	Max. Heating	13.6	16.0	16.5
Input power	Cooling	3.75	4.71	5.55
	Nominal Heating	3.22	3.77	4.33
	Max. Heating	3.99	5.04	5.32
EER	Cooling	3.22	2.97	2.72
	Nominal Heating	3.75	3.71	3.48
	Max. Heating	3.40	3.17	3.10
COP	Cooling	5.83	5.58	5.47
	Heating	3.82	3.96	3.99
SEER	Cooling	230.2	220.2	215.8
	Heating	149.8	155.4	156.6
SCOP	Cooling	4.240	4.400	4.400
	Heating	53 / 67	53 / 69	54 / 70
Airflow rate	Cooling	54 / 68	56 / 69	56 / 70
	Heating	Blue fin	Blue fin	Blue fin
Sound pressure level/Power level	Cooling	998	998	998
	Heating	970	970	970
	Height	370	370	370
Net Dimensions	Width	88	88	88
	Depth	R410A (2,088)	R410A (2,088)	R410A (2,088)
	Type (Global Warming Potential)	4.0 (8.4)	4.0 (8.4)	4.0 (8.4)
Refrigerant	Charge	9.52	9.52	9.52
	Liquid	15.88	15.88	15.88
	Gas	80	80	80
Connection pipe diameter	Liquid	30	30	30
	Gas	-5 to 46	-5 to 46	-5 to 46
Total pipe length	Cooling	-20 to 21	-20 to 21	-20 to 21
	Heating			
Max. height difference	Cooling			
	Heating			
Operating Range	Cooling			
	Heating			

Note: Specifications are based on the following conditions.  
Cooling: Indoor temperature of 27°CDB/19°CWB, and outdoor temperature of 35°CDB/24°CWB.  
Heating: Indoor temperature of 20°CDB/(15°CWB), and outdoor temperature of 7°CDB/6°CWB.  
Pipe length: 7.5 m; Height difference between outdoor unit and indoor unit: 0 m.  
The protective function may work when using it outside the operation range.

### Dimensions

(Unit: mm)

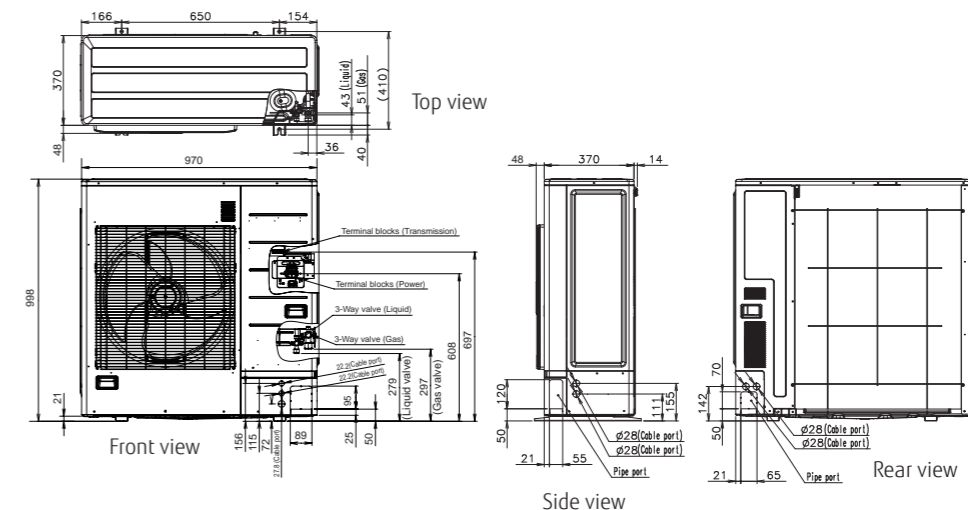



## Heat Pump for Small-capacity type

# VRF J-IV

### System configuration example

- Suitable for air conditioning small and medium-size buildings. One refrigerant system is used for each outdoor unit.
- Multiple indoor units are connected with separation tubes and headers.

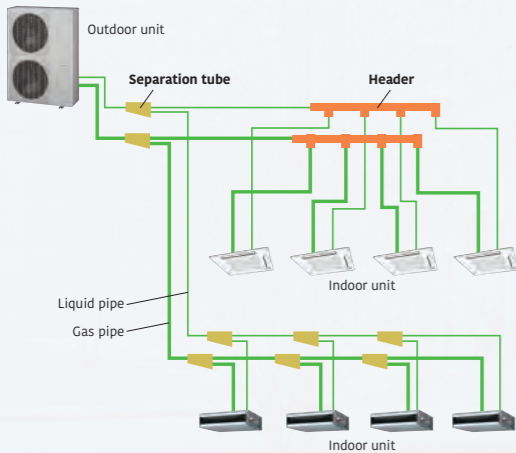

## Intelligent Refrigerant Control

The Intelligent refrigerant control operates with suitable control corresponding to the heat load of the room and offers a more comfortable environment. The Intelligent refrigerant control can also provide increased energy savings.

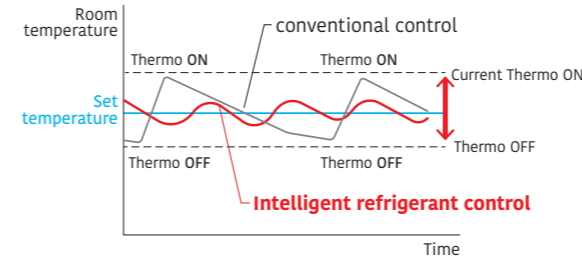

The thermostat is turned on and off less frequently than under conventional control to maintain the room temperature at the target temperature. Compared to conventional control, the compressor will run longer, thus saving energy.

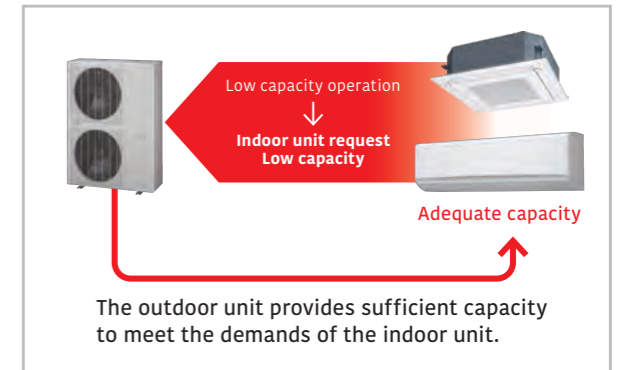

\* The improvements due to the control and the actual sine wave vary depending on the combination of the indoor unit and system operating conditions.

## External Static Pressure

External static pressure measures up to 30 Pa for 4/5/6 HP.



## Advanced High-Efficiency Technology

**Large propeller fan**  
A large propeller fan with an optimized blade angle achieves both high performance and low noise operation.

**DC fan motor**  
A small, multi-stage DC fan motor contributes to high-efficiency and low noise operation.

**Large heat exchanger**  
The large 3-row heat exchanger substantially improves heat-exchanging performance.

**DC inverter control**  
The active filter module improves efficiency.

**Subcooling heat exchanger**  
The dual-tube heat exchanger improves cooling performance.

**DC twin-rotary compressor**  
High-efficiency is achieved across compressor loads. Especially good performance is achieved in the low-to medium-load range.

High-efficiency compressor motor  
Optimized refrigerant flow design  
Highly accurate parts

Pressure  
effect  
Cooling performance improved  
Enthalpy

High  
Compressor efficiency  
DC Twin-Rotary Compressor  
Compressor capacity High

### Efficiency in Actual Operating Conditions

The use of a large heat exchanger and a high-efficiency Scroll compressor achieves class-leading EER/COP (Max. Heating) in all models.

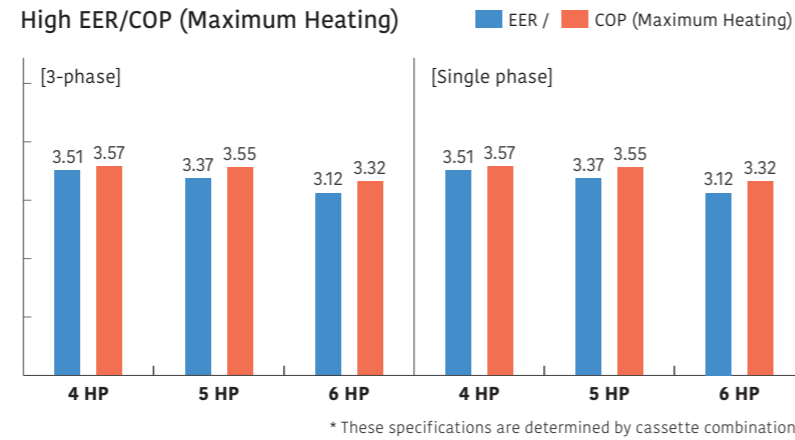

### Long Pipe Length

Our advanced refrigerant control technology allows us to achieve a total refrigerant pipe length of 180 m. This provides high flexibility in system design.

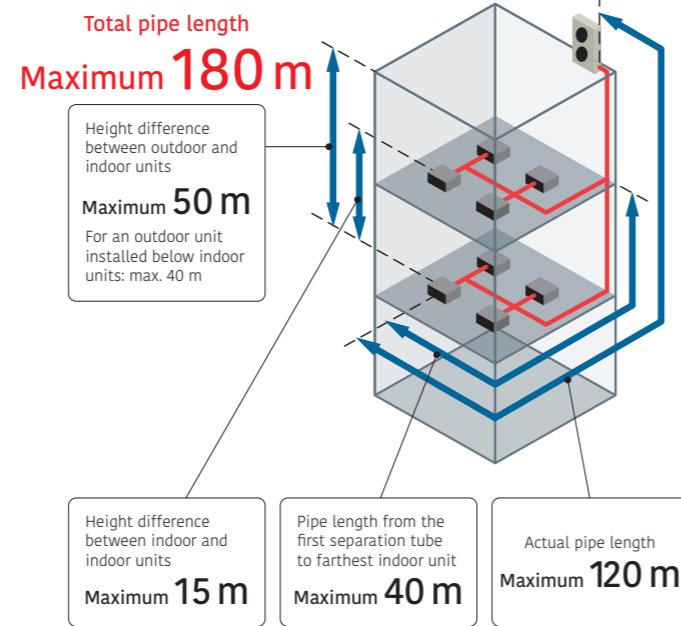

### Up to 14 Indoor Units\* can be Connected

The combination of smaller but sufficiently powerful indoor units and outdoor units with an optimized heat exchanging structure makes it possible to connect up to 14 indoor units, which is the best in its class.

\*: 6 HP model

Model	J-IV		
Rating Capacity range (HP)	4	5	6
Max. Connectable indoor unit	1-11	1-12	1-13

### Non-Stop Oil Recovery Operation

A comfortable room condition is maintained during oil recovery mode because the product continues to operate without stopping the cooling or heating operation.

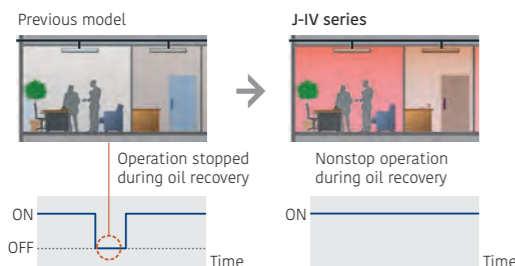

### Easier Installation

**Connection check function:** Wire connections and address settings can be checked thanks to the quick check run function.

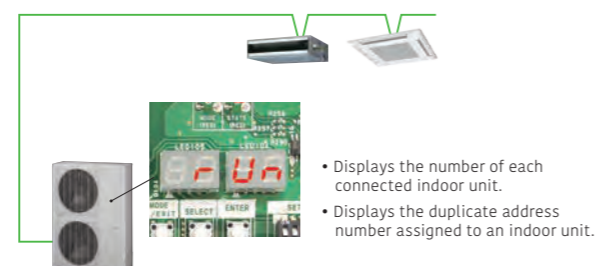

### 4,5,6HP: AJH040BLDH / AJH045BLDH / AJH054BLDH AJH040ELDH [3-phase] / AJH045ELDH [3-phase] / AJH054ELDH [3-phase]



### Specifications

Rated capacity range		HP	4	5	6	4	5	6
Model name			AJH040BLDH	AJH045BLDH	AJH054BLDH	AJH040ELDH	AJH045ELDH	AJH054ELDH
Maximum connectable indoor units			1-11	1-12	1-14	1-11	1-12	1-14
Power source			Single phase, 230V~, 50Hz			3-phase, 400V~, 50Hz		
Capacity	Cooling	kW	12.1	14.0	15.5	12.1	14.0	15.5
	Nominal Heating		12.1	14.0	15.5	12.1	14.0	15.5
	Max. Heating		13.6	16.0	18.0	13.6	16.0	18.0
Input power	Cooling	kW	3.44	4.15	4.96	3.44	4.15	4.96
	Nominal Heating		3.14	3.60	4.17	3.14	3.60	4.17
	Max. Heating		3.80	4.50	5.41	3.80	4.50	5.41
EER	Cooling		3.51	3.37	3.12	3.51	3.37	3.12
COP	Nominal Heating	W/W	3.85	3.88	3.71	3.85	3.88	3.71
	Max. Heating		3.57	3.55	3.32	3.57	3.55	3.32
	SEER		Cooling	6.52	6.43	6.14	6.52	6.43
SCOP	Heating		3.58	3.89	3.85	3.58	3.89	3.85
ηc	Cooling	%	257.8	254.2	242.6	257.8	254.2	242.6
	ηh		Heating	140.2	152.6	151.0	140.2	152.6
Airflow rate		m³/h	6,200	6,600	7,000	6,200	6,600	7,000
Sound pressure level/ Power level	Cooling	dB(A)	50 / 65	52 / 66	53 / 67	50 / 65	52 / 66	53 / 67
	Heating		52 / 67	55 / 69	56 / 69	52 / 67	55 / 69	56 / 69
Heat exchanger fin			Blue fin	Blue fin	Blue fin	Blue fin	Blue fin	Blue fin
	Height	mm	1,334	1,334	1,334	1,334	1,334	1,334
	Width		970	970	970	970	970	970
Depth	370		370	370	370	370	370	
Weight		kg	117	117	119	118	119	119
	Refrigerant	Type (Global Warming Potential)	R410A (2,088)	R410A (2,088)	R410A (2,088)	R410A (2,088)	R410A (2,088)	R410A (2,088)
Charge		kg (CO2eq-T)	4.8 (10.0)	5.3 (11.1)	5.3 (11.1)	4.8 (10.0)	5.3 (11.1)	5.3 (11.1)
	Connection pipe diameter	Liquid	9.52	9.52	9.52	9.52	9.52	9.52
Total pipe length	Gas	mm	15.88	15.88	19.05	15.88	15.88	19.05
	Max. height difference	m	180	180	180	180	180	180
Operating Range	Cooling	°C	-5 to 46	-5 to 46	-5 to 46	-5 to 46	-5 to 46	-5 to 46
	Heating		-20 to 21	-20 to 21	-20 to 21	-20 to 21	-20 to 21	-20 to 21

Note: Specifications are based on the following conditions.  
Cooling: Indoor temperature of 27°CDB/19°CWB, and outdoor temperature of 35°CDB/24°CWB.  
Heating: Indoor temperature of 20°CDB/(15°CWB), and outdoor temperature of 7°CDB/6°CWB.  
Pipe length: 7.5 m; Height difference between outdoor unit and indoor unit: 0 m.  
The protective function may work when using it outside the operation range.

### Dimensions

(Unit: mm)

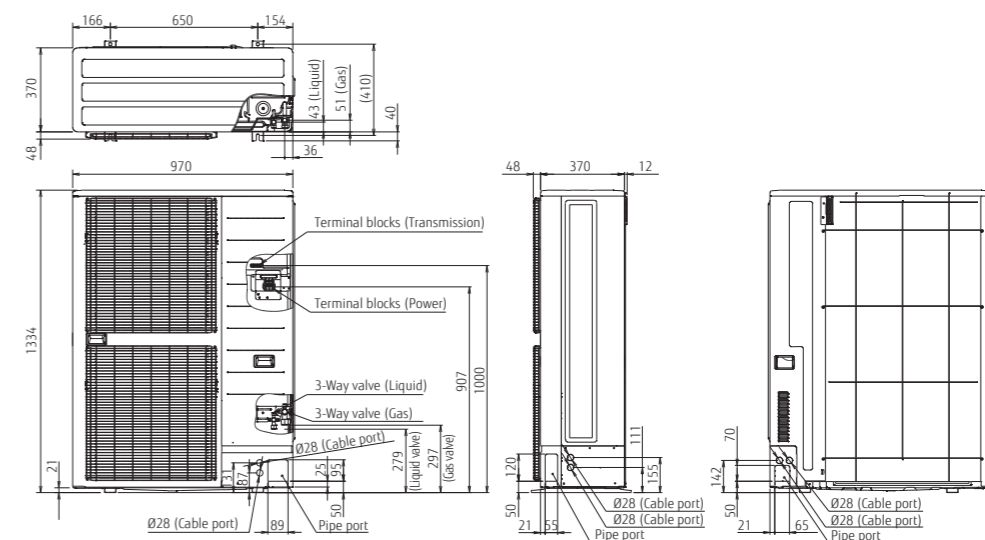



## Heat Pump for Small-capacity type

# VRF J-IVL

### System configuration example

- Suitable for air conditioning small and medium-size buildings. One refrigerant system is used for each outdoor unit.
- Multiple indoor units are connected with separation tubes and headers.

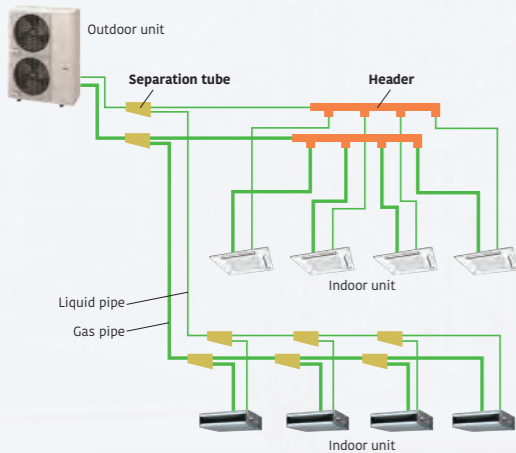

## Intelligent Refrigerant Control

The Intelligent refrigerant control operates with suitable control corresponding to the heat load of the room and offers a more comfortable environment. The Intelligent refrigerant control can also provide increased energy savings.

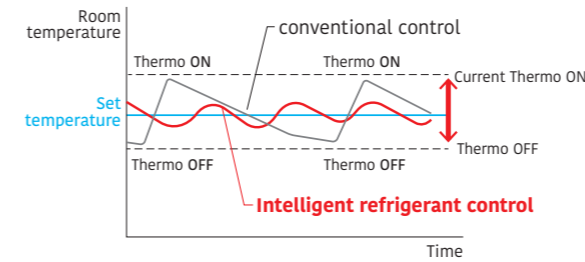

The thermostat is turned on and off less frequently than under conventional control to maintain the room temperature at the target temperature. Compared to conventional control, the compressor will run longer, thus saving energy.



\* The improvements due to the control and the actual sine wave vary depending on the combination of the indoor unit and system operating conditions.

## External Static Pressure

External static pressure is available up to 60 Pa for 14/16/18 HP. (30 Pa for 8/10 HP, 40 Pa for 12 HP)  
Capacities are slightly decreased relative to the rated values during high static pressure operations.



## Advanced High-Efficiency Technology

**Ø570 mm Large propeller fan**  
A large-diameter propeller fan with our proprietary blade design reduces draft loss, which results in high-efficiency and low noise operation.

**DC fan motor**  
A small, multi-stage DC fan motor provides high-efficiency and low noise operation.

**DC inverter control**  
The active filter module improves efficiency.

**Subcooling heat exchanger**  
The dual-tube heat exchanger improves cooling performance.

**Large heat exchanger**  
The large 2.6-row heat exchanger substantially improves heat-exchanging performance.

**Scroll compressor**  
The combination of a scroll compressor with a wide rotational frequency range from 15 to 130 rps and our proprietary sensorless sine-wave control that smoothly controls the input power into the motor achieves more energy-efficient and quieter operation.



General offers a perfect total air conditioning system for small office buildings with multiple small rooms, taking into consideration energy savings, low noise, comfortable air volume, usage and purpose, and centralized control.

# VRF J-IVL

Image: 8/10/12 HP models

## Slim & Compact Design

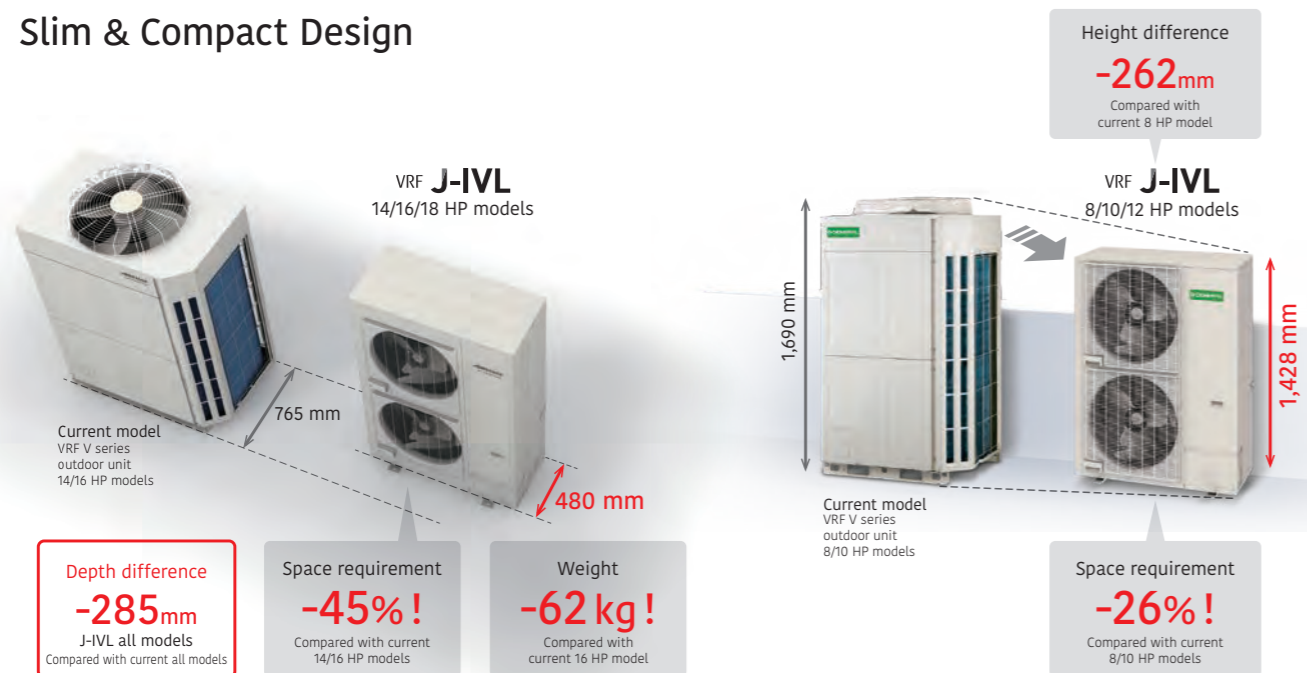

## Various Installation Methods

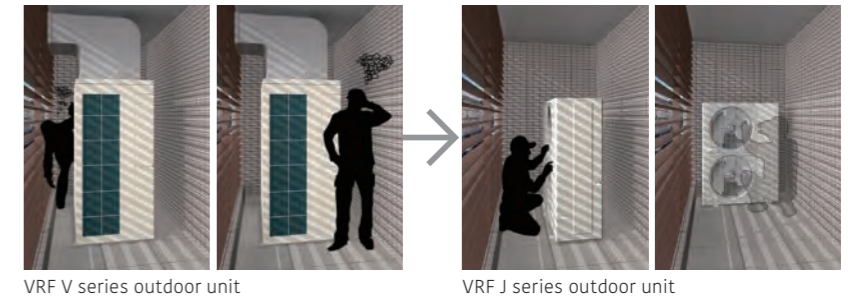

### Installation

#### Low noise level in consideration of nearby residents

Front air discharge type with a width of about 1,000 mm, allowing for flexible installation even in narrow spaces.



### Narrow space behind building

#### Space saving

Small and thin, allowing for direct ground or wall mounting installations even in narrow alleys.



### Installation on the back street of a building

#### Flexible installation

Slim, low-body front air discharge meets the requirements for installation even in tight spaces. Installation flexibility without blocking the windows of buildings contributes to substantial space savings, even when multiple units are installed.

### Efficiency in Actual Operating Conditions

The use of a large heat exchanger and a high-efficiency Scroll compressor achieves class-leading EER/COP (Max. Heating) in all models.

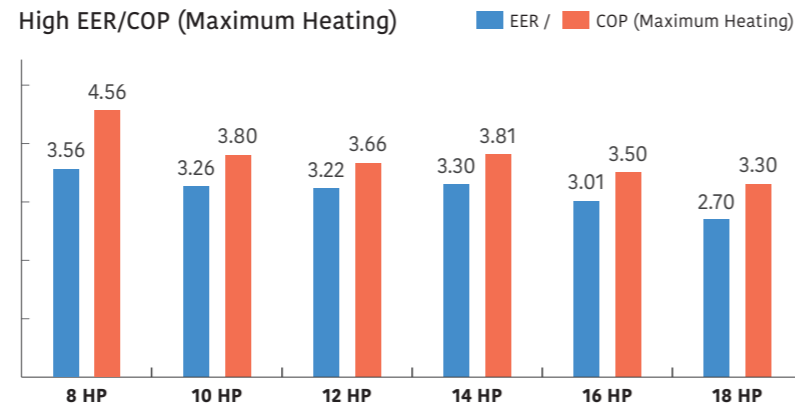

\* These specifications are determined by cassette combination.

### Long Pipe Length

Our advanced refrigerant control technology extends the maximum allowable length of refrigerant pipe to 400 m. This provides high flexibility in system design.

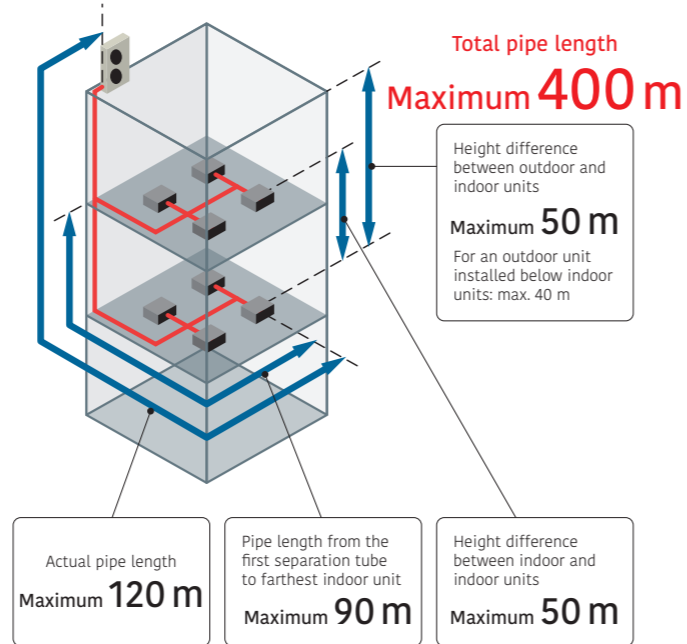

### Up to 42 Indoor Units\* can be Connected.

The combination of smaller but sufficiently powerful indoor units and a outdoor unit with an optimized heat exchanging structure makes it possible to connect up to 42 indoor units, which is the best in its class.

\*: 18 HP model

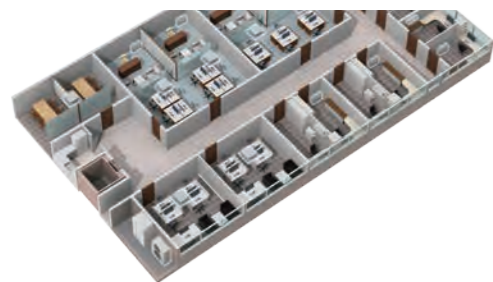

### Class-Leading Low Operating Sound

The top-class low operating noise makes it ideal for use in densely populated areas. These low operating sound models are ideal for installation in densely populated areas.

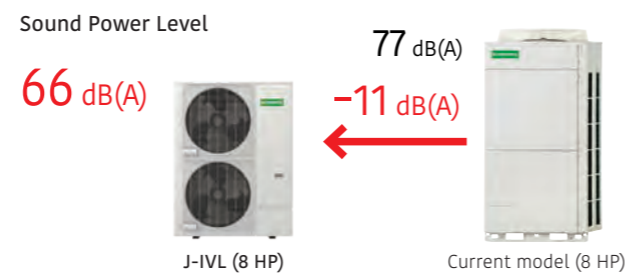

8,10,12 HP: AJH072LELDH / AJH090LELDH / AJH108LELDH  
14,16,18 HP: AJH126LELDH / AJH144LELDH / AJH162LELDH



### Specifications

Rated capacity range		HP	8	10	12	14	16	18
Model name			AJH072LELDH	AJH090LELDH	AJH108LELDH	AJH126LELDH	AJH144LELDH	AJH162LELDH
Maximum connectable indoor units			1-20	1-25	1-30	1-36	1-40	1-42
Power source			3-phase, 400V~, 50Hz					
Capacity	Cooling	kW	22.4	28.0	33.5	40.0	45.0	50.0
	Nominal Heating	kW	22.4	28.0	33.5	40.0	45.0	50.0
	Max. Heating	kW	25.0	31.5	37.5	45.0	50.0	55.0
Input power	Cooling	kW	6.30	8.59	10.42	12.12	14.96	18.52
	Nominal Heating	kW	4.65	6.61	8.18	9.71	11.81	13.66
	Max. Heating	kW	5.45	8.29	10.25	11.81	14.29	16.66
EER	Cooling		3.56	3.26	3.22	3.30	3.01	2.70
	Nominal Heating	W/W	4.82	4.24	4.10	4.12	3.81	3.66
COP	Max. Heating	W/W	4.56	3.80	3.66	3.81	3.50	3.30
	SEER	Cooling	7.62	7.50	7.27	7.27	7.00	6.29
SCOP	Heating		3.89	3.61	3.63	3.53	3.51	3.54
	ηc	Cooling	301.8	297.0	287.8	287.8	277.0	248.6
ηh	Heating	%	152.6	141.4	142.2	138.2	137.4	138.6
	Airflow rate	m³/h	8,400	9,000	11,000/12,100	13,000	14,000	14,800/15,300
Sound pressure level/ Power level	Cooling	dB(A)	52/66	54/69	59/73	62/75	64/77	65/79
	Heating	dB(A)	54/66	57/70	62/75	63/76	65/78	68/82
Net Dimensions	Height	mm	1,428	1,428	1,428	1,638	1,638	1,638
	Width	mm	1,080	1,080	1,080	1,080	1,080	1,080
	Depth	mm	480	480	480	480	480	480
Weight		kg	170	177	178	213	213	217
	Refrigerant	Type (Global Warming Potential)	R410A (2,088)	R410A (2,088)	R410A (2,088)	R410A (2,088)	R410A (2,088)	R410A (2,088)
Connection pipe diameter	Charge	kg (CO2eq-T)	7.0 (14.6)	7.5 (15.7)	7.5 (15.7)	11.0 (23.0)	11.0 (23.0)	11.8 (24.6)
	Liquid	mm	9.52	9.52	12.70	12.70	12.70	12.70
Total pipe length	Gas	mm	19.05	22.20	28.58	28.58	28.58	28.58
	Max. height difference	m	400	400	400	400	400	400
Operating Range	Cooling	°C	-15 to 46	-15 to 46	-15 to 46	-5 to 46*	-5 to 46*	-5 to 46*
	Heating	°C	-20 to 21	-20 to 21	-20 to 21	-20 to 21	-20 to 21	-20 to 21

Note: Specifications are based on the following conditions.  
Cooling: Indoor temperature of 27°CDB / 19°CWB, and outdoor temperature of 35°CDB / 24°CWB.  
Heating: Indoor temperature of 20°CDB / (15°CWB), and outdoor temperature of 7°CDB / 6°CWB.  
Pipe length: 7.5 m; Height difference between outdoor unit and indoor unit: 0 m.  
\* The cooling operation range of -15 to 46°C is allowed only when all of the indoor units connected to the system are higher than capacity of 5.6kW.

### Dimensions

(Unit: mm)

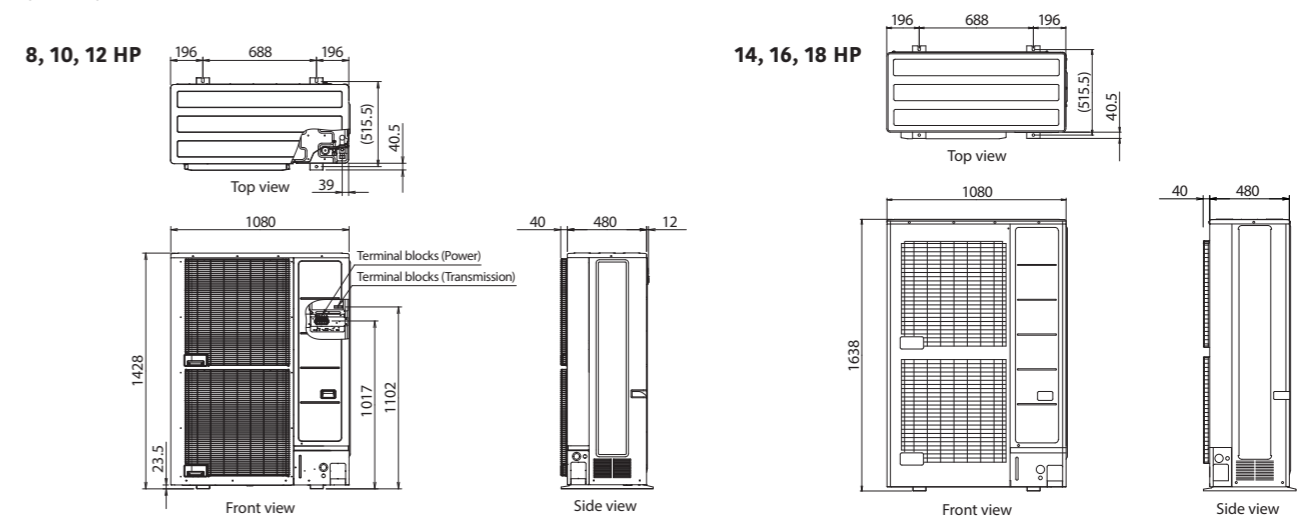



**Heat Recovery**  
Modular type

VRF **VR-IV**

**Highly energy-efficient operation**

Our heat recovery systems achieve high operating energy efficiency by drawing heat from the room to be cooled and transferring it as energy for rooms that are to be heated.

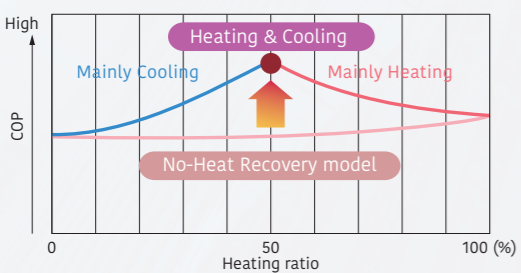
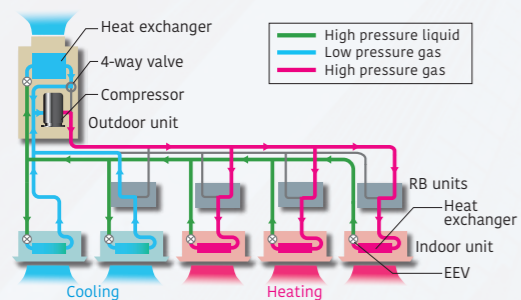

**Intelligent Refrigerant Control**

The Intelligent refrigerant control operates with suitable control corresponding to the heat load of the room and offers a more comfortable environment. The Intelligent refrigerant control can also provide increased energy savings.

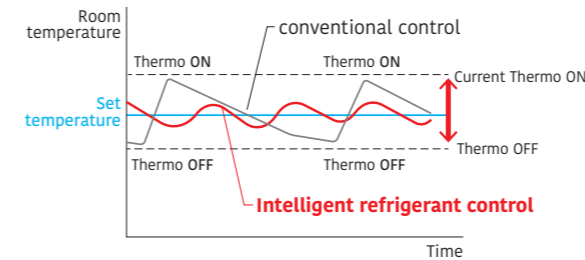

The thermostat is turned on and off less frequently than under conventional control to maintain the room temperature at the target temperature. Compared to conventional control, the compressor will run longer, thus saving energy.



\* The improvements due to the control and the actual sine wave vary depending on the combination of the indoor unit and system operating conditions.

**Increase in The Number of Connectable Indoor Units**

Capacity range of connectable indoor units

<b>VR-IV</b>	<b>25%* to 150%</b>
Current model (VR-II)	50% to 150%

\*: For modular type, 25% to 49.9% operation in the entire system is available. (by one unit operation)

Increased number of connectable indoor units and space saving combinations (Unit)

HP	10	12	14	16	...	28	30	32	...	48	
<b>VR-IV</b>	<b>21</b>	<b>26</b>	<b>30</b>	<b>34</b>	...	<b>60</b>	<b>64</b>	<b>64</b>	...	<b>64</b>	
Current model (VR-II)	15	16	17	21	24	...	42	45	48	...	64

**The Energy-Saving Technology that Boosted Operation Efficiency**

- Powerful large propeller fan**  
The fan uses CFD\* technology to achieve both high performance and low noise operation.  
\*CFD: Computational Fluid Dynamics
- 3-phase DC fan motor**  
The use of a DC fan motor with sophisticated driver control improves energy efficiency substantially. In addition, this motor operates quietly.
- Subcooling heat exchanger**  
High heat exchange efficiency is achieved by using an internal projection-shape double-pipe construction.
- High-efficient, large-capacity DC twin-rotary compressor**  
Large-capacity high-efficient DC twin-rotary compressor with excellent intermediate capability.
- Sine-wave DC inverter control**  
High-efficiency is realized by the adoption of reduced switching loss IPM.
- 4-face heat exchanger**  
The 4-face heat exchanger increases the effective surface area and significantly improves heat-exchanging efficiency.
- Front intake port (Corner cut air inlet structure)**  
In multiple outdoor unit installations, the unique front intake design improves airflow into the heat exchanger.

## Extended Connection Ratio (Applicable to Multiple Tenants)

Especially useful when starting partial air conditioning in a building under construction Installation can be added flexibly for each tenant.



### Stand-Alone

Current model (VR-II)

**Example** 50% of 12HP minimum connected indoor unit capacity is required

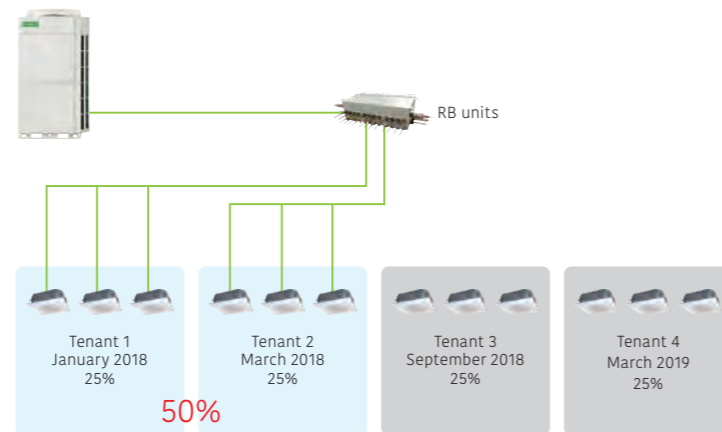

Installation is possible even for tenants who have not yet started operations.

### VR-IV

**Example** 25% of 12HP minimum connected indoor unit capacity is required

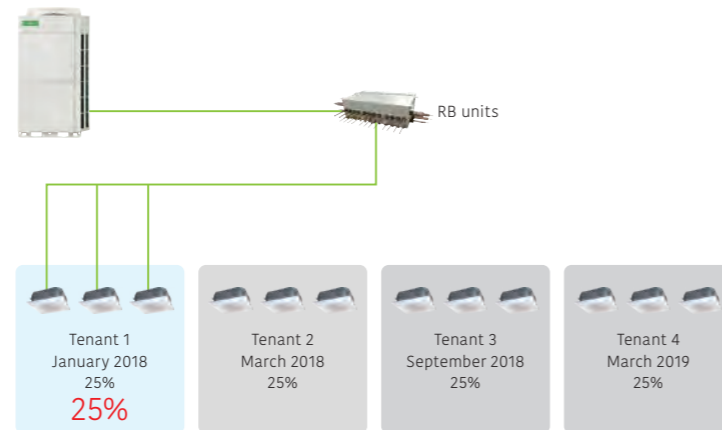

Installation and commissioning can be added flexibly to meet the opening dates of other tenants.

### Modular Type

One outdoor unit operates effectively for the capacities of connectable indoor units in the entire system. (Each of the multiple outdoor units does not dare to operate at 25% capacity: any one of the outdoor units will operate at 50% and the remaining units will each output 0%, i.e., stop operating.)

**Example:** One 10HP outdoor unit performs 25% of the total 20HP outdoor units system.  
One 10HP outdoor unit performs 50% of its capacity  
→ Two outdoor units do not perform 25% of the operation.



## Additional Installation is Possible without Changing The Main Pipe

A main pipe of a diameter that can be used for the final system is installed at the beginning of the installation. Duplication of the work will be avoided as there is no need to change the main pipe as in the previous model.

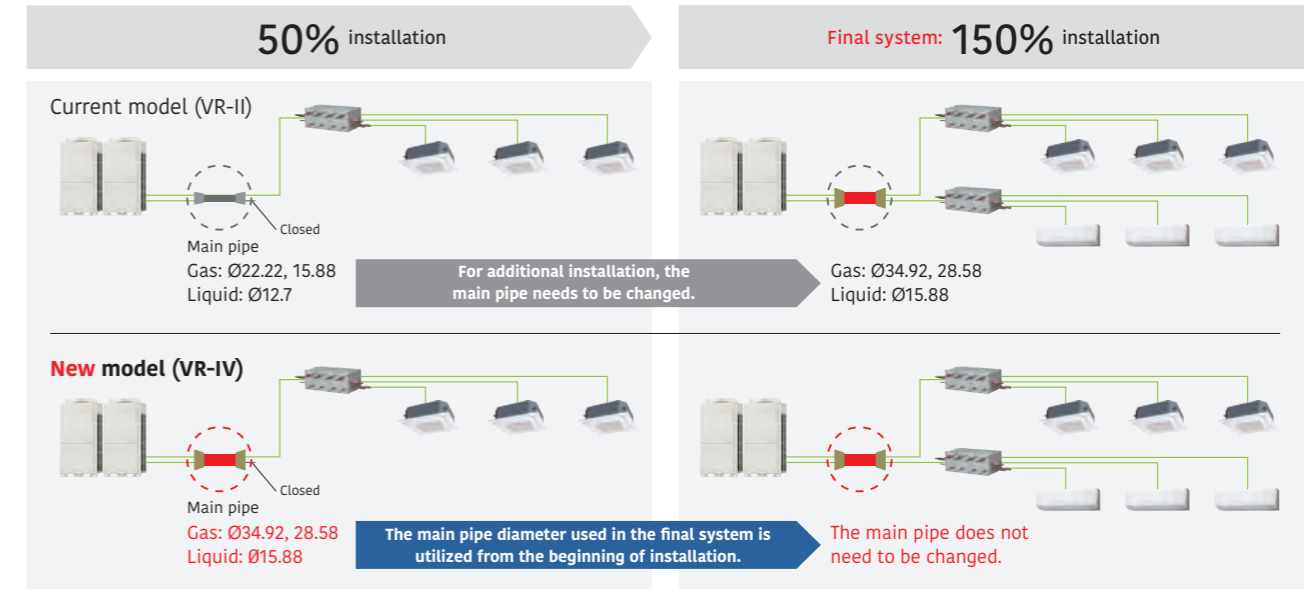

## All-Inverter Compressor

### Large-capacity DC inverter compressor

Large-capacity high-efficient DC twin-rotary compressor with excellent intermediate capability.



### High-efficiency compressor speed control

The compressor speed control in 0.1 Hz increments ensures a comfortable space with less change in room temperature and less energy loss.

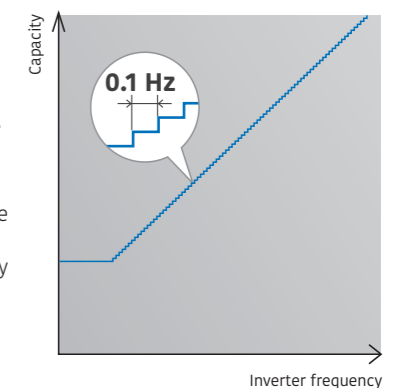

### Efficiency in Actual Operating Conditions

Class-leading high COP (Maximum) The use of our proprietary heat exchanger structure and high-efficiency DC twin-rotary compressors achieves the class-leading coefficient of performance (COP) in every combination.

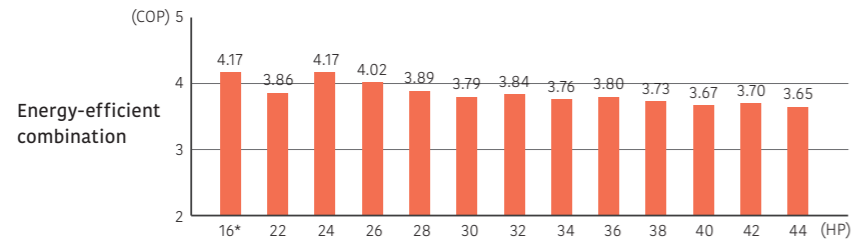
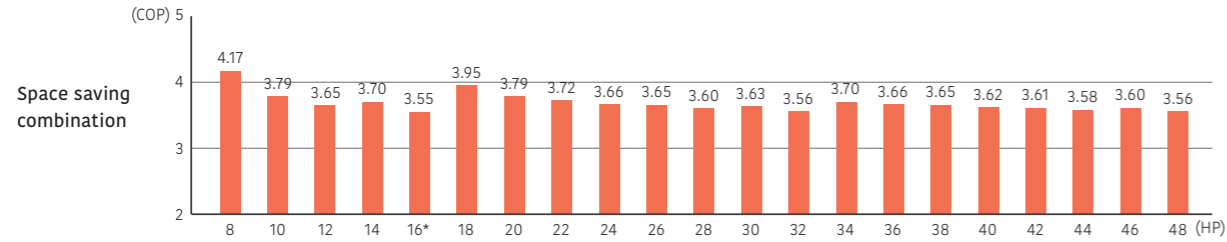

\* These specifications are determined by Cassette combination.  
\* Multiple outdoor units are not certified by Eurovent.

### Multiple Outdoor Operation Control

When multiple outdoor units are connected, each compressor carries out sophisticated operation. Instead of operating one compressor at full load to distribute the refrigerant to one heat exchanger, all compressors operate at partial load to distribute the refrigerant to all heat exchangers, thereby improving the efficiency of the entire system.

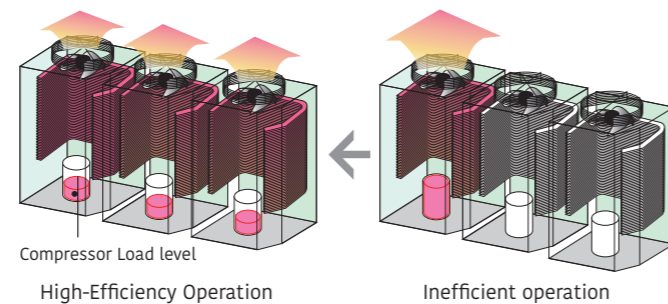

### Heat Exchanger Refrigerant Control

The heat exchanger in the outdoor unit is divided into two parts, upper and lower. The efficiency of the heat exchanger has been improved by adopting an optimum refrigerant path control where the refrigerant is distributed more into the top heat exchanger as this is where there is a greater airflow intake.

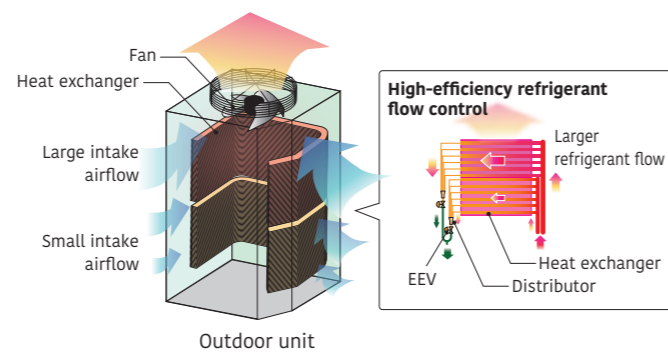

### Flexible Pipe Connection

More flexible refrigerant pipe work is possible due to the use of various pipe connection and RB unit connections, for adjustments to the floor layout and building structure.

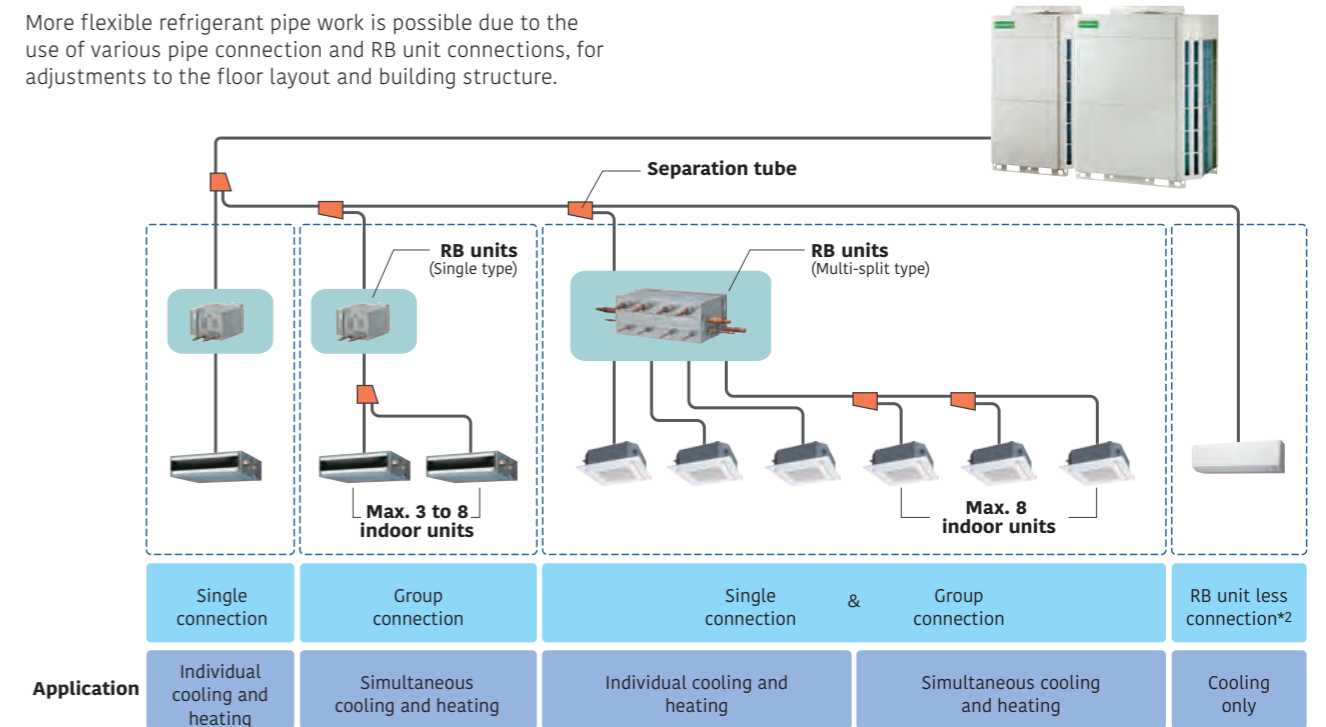

• An RB unit can be placed between the first branch and an indoor unit.  
• The maximum height difference between RB units is 15 m.  
No RB Unit is required for cooling only use.

### Flexible Installation of RB Unit

Small and slim design with a height of 198 mm makes it easy to install in tight spaces with height constraints.

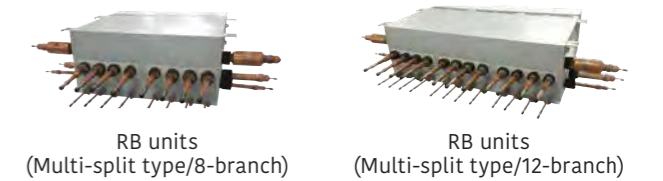

- A drain pipe is not required.
- Different positions of a control box can be chosen to accommodate installation conditions.
- Series connection for simplified installation

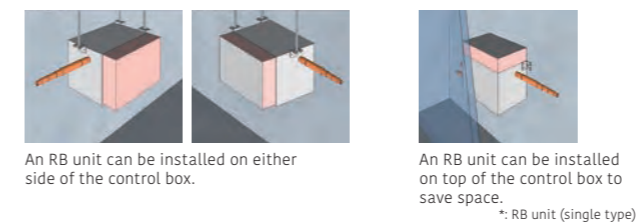

### Easy maintenance in tight spaces

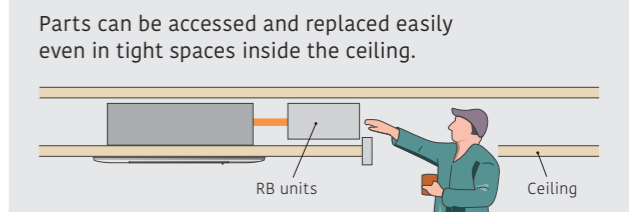
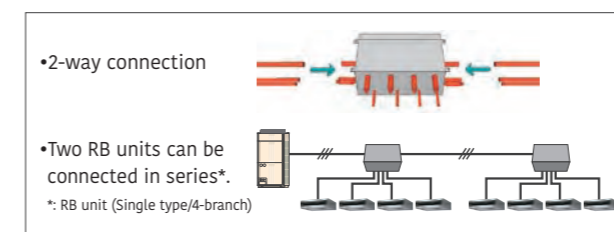
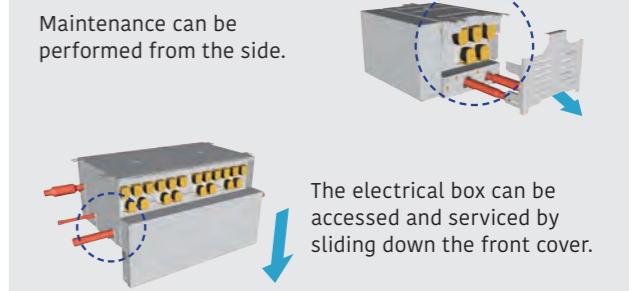

Outdoor units lineup • Combinations other than those listed below are not recommended.

Space saving combination

22.4kW (8HP) AJH072GALDH UNIT : AJH072GALDH	28.0kW (10HP) AJH090GALDH UNIT : AJH090GALDH	33.5kW (12HP) AJH108GALDH UNIT : AJH108GALDH	40.0kW (14HP) AJH126GALDH UNIT : AJH126GALDH	45.0kW (16HP) AJH144GALDH UNIT : AJH144GALDH
50.4kW (18HP) AJH162GALDH UNIT : AJH090/072GALDH	56.0kW (20HP) AJH180GALDH UNIT : AJH090/090GALDH	61.5kW (22HP) AJH198GALDH UNIT : AJH108/090GALDH	67.0kW (24HP) AJH216GALDH UNIT : AJH108/108GALDH	73.0kW (26HP) AJH234GALDH UNIT : AJH144/090GALDH
78.5kW (28HP) AJH252GALDH UNIT : AJH144/108GALDH	85.0kW (30HP) AJH270GALDH UNIT : AJH144/126GALDH	90.0kW (32HP) AJH288GALDH UNIT : AJH144/144GALDH	95.0kW (34HP) AJH306GALDH UNIT : AJH108/108/090GALDH	100.5kW (36HP) AJH324GALDH UNIT : AJH108/108/108GALDH
106.5kW (38HP) AJH342GALDH UNIT : AJH144/108/090GALDH	112.0kW (40HP) AJH360GALDH UNIT : AJH144/108/108GALDH	118.0kW (42HP) AJH378GALDH UNIT : AJH144/144/090GALDH	123.5kW (44HP) AJH396GALDH UNIT : AJH144/144/108GALDH	130.0kW (46HP) AJH414GALDH UNIT : AJH144/144/126GALDH
135.0kW (48HP) AJH432GALDH UNIT : AJH144/144/144GALDH				

Energy efficiency combination

44.8kW (16HP) AJH144GALDHH UNIT : AJH072/072GALDH	62.4kW (22HP) AJH198GALDHH UNIT : AJH126/072GALDH	67.2kW (24HP) AJH216GALDHH UNIT : AJH072/072/072GALDH	72.8kW (26HP) AJH234GALDHH UNIT : AJH090/072/072GALDH	78.4kW (28HP) AJH252GALDHH UNIT : AJH090/090/072GALDH
84.0kW (30HP) AJH270GALDHH UNIT : AJH090/090/090GALDH	90.4kW (32HP) AJH288GALDHH UNIT : AJH126/090/072GALDH	96.0kW (34HP) AJH306GALDHH UNIT : AJH126/090/090GALDH	102.4kW (36HP) AJH324GALDHH UNIT : AJH126/126/072GALDH	108.0kW (38HP) AJH342GALDHH UNIT : AJH126/126/090GALDH
113.0kW (40HP) AJH360GALDHH UNIT : AJH144/126/090GALDH	120.0kW (42HP) AJH378GALDHH UNIT : AJH126/126/126GALDH	125.0kW (44HP) AJH396GALDHH UNIT : AJH144/126/126GALDH		

8,10,12HP : AJH072GALDH / AJH090GALDH / AJH108GALDH  
14,16HP : AJH126GALDH / AJH144GALDH



8, 10, 12 HP

14, 16 HP

Dimensions

(Unit: mm)

8, 10, 12 HP

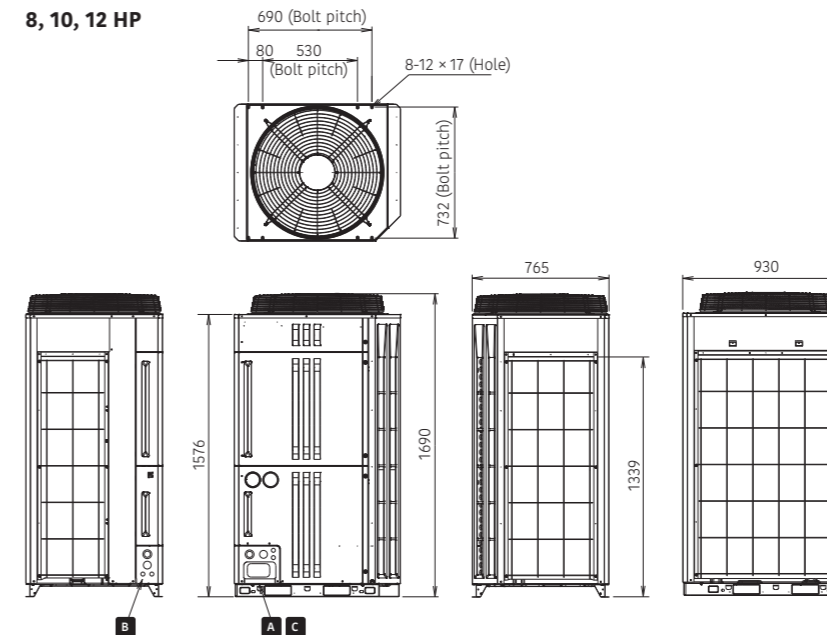

14, 16 HP

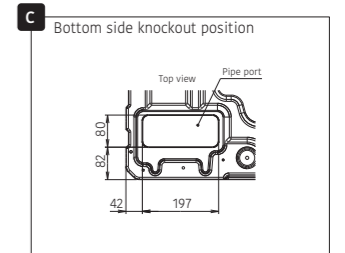
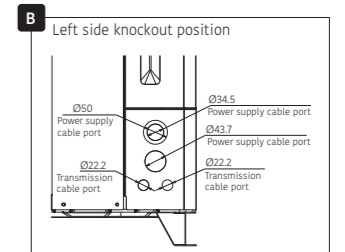
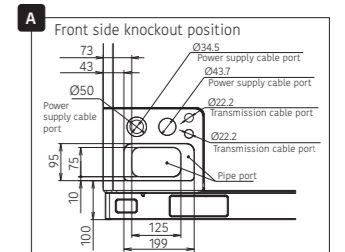
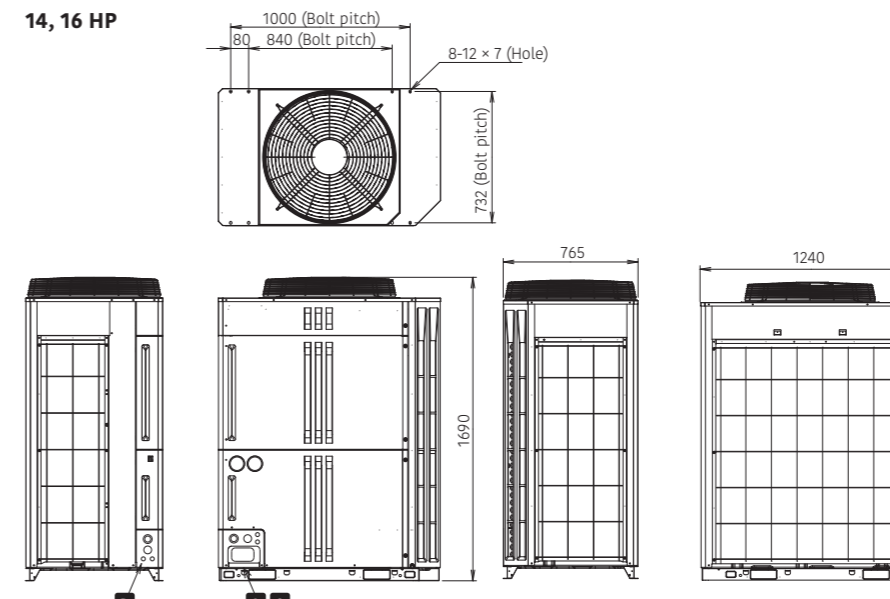

Outdoor units specifications

Space saving combination

Table with columns for Rated capacity range (8, 10, 12, 14, 16, 18, 20, 22, 24, 26, 28, 30, 32, 34, 36, 38, 40, 42, 44, 46, 48) and rows for Model name, Unit 1-3, Maximum connectable indoor units\*1, Connectable capacity range of indoor units, Power source, Capacity, Input power, EER, COP, SEER, SCOP, ηc, ηh, Air flow rate, Sound pressure level\*2/Power level, Max. External static pressure, Compressor motor output, Heat exchanger fin, Net Dimensions, Weight, Refrigerant, Connection pipe diameter, and Operating Range.

Energy Efficiency Combination

Table with columns for Rated capacity range (16, 22, 24, 26, 28, 30, 32, 34, 36, 38, 40, 42, 44) and rows for Model name, Unit 1-3, Maximum connectable indoor units\*1, Connectable capacity range of indoor units, Power source, Capacity, Input power, EER, COP, SEER, SCOP, ηc, ηh, Air flow rate, Sound pressure level\*2/Power level, Max. External static pressure, Compressor motor output, Heat exchanger fin, Net Dimensions, Weight, Refrigerant, Connection pipe diameter, and Operating Range.

Note: Specifications are based on the following conditions.

Cooling: indoor temperature of 27°CDB/19°CWB, and outdoor temperature of 35°CDB/24°CWB. Heating: indoor temperature of 20°CDB/15°CWB, and outdoor temperature of 7°CDB/6°CWB. Pipe length: 7.5 m; Height difference between outdoor unit and indoor unit: 0 m.

When cooling operation is to be conducted at an outdoor air temperature below -5°C, the outdoor unit must be installed in a position that is higher than or equal to that of the indoor units. \* These specifications are determined by ducted combination. \* Multiple outdoor units are not certified by Eurovent.

\*1: Minimum connectable indoor unit number is 2.

\*2: The noise level is the value measured in an anechoic room. When measured in an actual installation, the measured value is typically larger than the indicated value due to ambient noise and reflections.

\*3: If the capacity range of the connectable indoor units is between 25% and 49.9%, do not open the three-way valve except for the unit to be operated. In addition, do not connect the power line.



**Heat Pump**  
Modular type

**VRF V-IV**

**System configuration example**

- Suitable for air conditioning midsize and large buildings. Connecting each outdoor unit makes it possible to create a high-capacity system.
- Multiple indoor units are connected with separation tubes and headers.

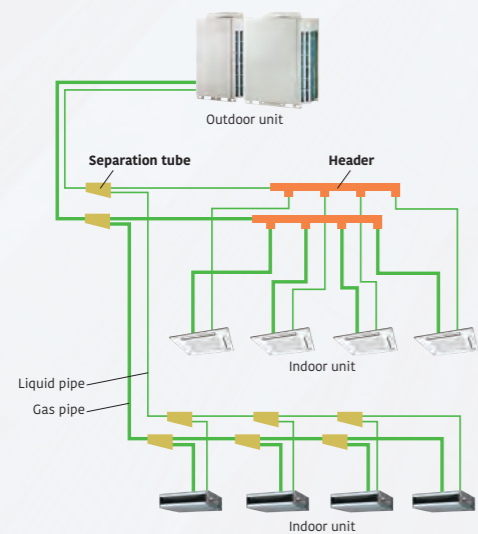

**Intelligent Refrigerant Control**

General is proposing outdoor units equipped with refrigerant control function. The refrigerant control operates with suitable control corresponding to the heat load of the room and offers a more comfortable environment. The refrigerant control can also provide increased energy savings.

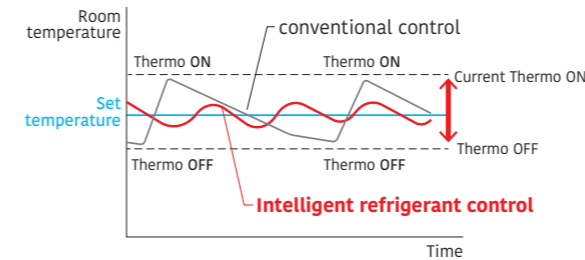

The thermostat is turned on and off less frequently than under conventional control to maintain the room temperature at the target temperature. Compared to conventional control, the compressor will run longer, thus saving energy.

\* The improvements due to the control and the actual sine wave vary depending on the combination of the indoor unit and system operating conditions.

**Efficiency in Actual Operating Conditions**

The use of our proprietary heat exchanger structure and high-efficiency DC twin-rotary compressors achieves the class-leading coefficient of performance (COP) in every combination.

Space saving combination

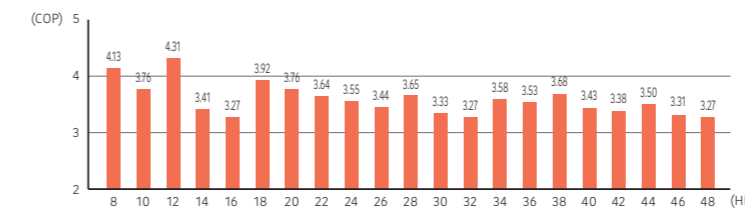

Energy efficiency combination

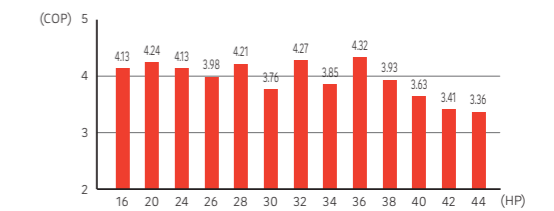

\* These specifications are determined by Cassette combination.

\*Multiple outdoor units are not certified by Eurovent.

**The Energy-Saving Technology that Boosted Operation Efficiency**



- Powerful large propeller fan**  
The fan uses CFD\* technology to achieve both high performance and low noise operation. \*CFD: Computational Fluid Dynamics
- 3-phase DC fan motor**  
The use of a DC fan motor with sophisticated driver control improves energy efficiency substantially. In addition, low noise is realized by the DC fan motor.
- Sine-wave DC inverter control**  
High-efficiency is realized by the adoption of reduced switching loss IPM.
- 4-face heat exchanger**  
The 4-face heat exchanger increases the effective surface area and significantly improves heat-exchanging efficiency.
- Subcooling heat exchanger**  
High heat exchange efficiency is achieved by using an internal projection-shape double-pipe construction.
- High-efficient, large-capacity DC twin-rotary compressor**  
Large-capacity high-efficient DC twin-rotary compressor with excellent intermediate capability.
- Front intake port (Corner cut air inlet structure)**  
In multiple outdoor unit installations, the unique front intake design improves airflow into the heat exchanger.

Outdoor units lineup - Combinations other than those listed below are not recommended.

Space saving combination

22.4 kW (8 HP) AJH072LALDH UNIT: AJH072LALDH	28.0 kW (10 HP) AJH090LALDH UNIT: AJH090LALDH	33.5 kW (12 HP) AJH108LALDH UNIT: AJH108LALDH	40.0 kW (14 HP) AJH126LALDH UNIT: AJH126LALDH	45.0 kW (16 HP) AJH144LALDH UNIT: AJH144LALDH
50.4 kW (18 HP) AJH162LALDH UNIT: AJH090/072LALDH	56.0 kW (20 HP) AJH180LALDH UNIT: AJH090/090LALDH	62.4 kW (22 HP) AJH198LALDH UNIT: AJH126/072LALDH	68.0 kW (24 HP) AJH216LALDH UNIT: AJH126/090LALDH	73.0 kW (26 HP) AJH234LALDH UNIT: AJH144/090LALDH
78.5 kW (28 HP) AJH252LALDH UNIT: AJH144/108LALDH	85.0 kW (30 HP) AJH270LALDH UNIT: AJH144/126LALDH	90.0 kW (32 HP) AJH288LALDH UNIT: AJH144/144LALDH	95.4 kW (34 HP) AJH306LALDH UNIT: AJH144/090/072LALDH	101.0 kW (36 HP) AJH324LALDH UNIT: AJH144/090/090LALDH
106.5 kW (38 HP) AJH342LALDH UNIT: AJH144/108/090LALDH	113.0 kW (40 HP) AJH360LALDH UNIT: AJH144/126/090LALDH	118.0 kW (42 HP) AJH378LALDH UNIT: AJH144/144/090LALDH	123.5 kW (44 HP) AJH396LALDH UNIT: AJH144/144/108LALDH	130.0 kW (46 HP) AJH414LALDH UNIT: AJH144/144/126LALDH
135.0 kW (48 HP) AJH432LALDH UNIT: AJH144/144/144LALDH				

Energy efficiency combination

44.8 kW (16 HP) AJH144LALDHH UNIT: AJH072/072LALDH	55.9 kW (20 HP) AJH180LALDHH UNIT: AJH108/072LALDH	67.2 kW (24 HP) AJH216LALDHH UNIT: AJH072/072/072LALDH	72.8 kW (26 HP) AJH234LALDHH UNIT: AJH090/072/072LALDH	78.3 kW (28 HP) AJH252LALDHH UNIT: AJH108/072/072LALDH
84.8 kW (30 HP) AJH270LALDHH UNIT: AJH126/072/072LALDH	89.4 kW (32 HP) AJH288LALDHH UNIT: AJH108/108/072LALDH	95.9 kW (34 HP) AJH306LALDHH UNIT: AJH126/108/072LALDH	100.5 kW (36 HP) AJH324LALDHH UNIT: AJH108/108/108LALDH	107.0 kW (38 HP) AJH342LALDHH UNIT: AJH126/108/108LALDH
113.5 kW (40 HP) AJH360LALDHH UNIT: AJH126/126/108LALDH	120.0 kW (42 HP) AJH378LALDHH UNIT: AJH126/126/126LALDH	125.0 kW (44 HP) AJH396LALDHH UNIT: AJH144/126/126LALDH		

8, 10 HP: AJH072LALDH / AJH090LALDH  
12, 14, 16 HP: AJH108LALDH / AJH126LALDH / AJH144LALDH



8, 10 HP

12, 14, 16 HP

Dimensions

(Unit: mm)

8, 10 HP

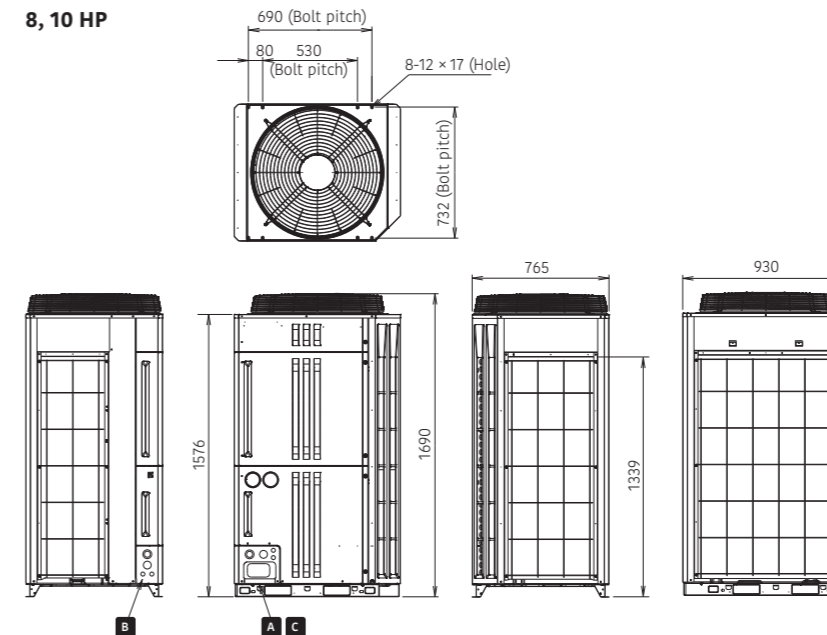

12, 14, 16 HP

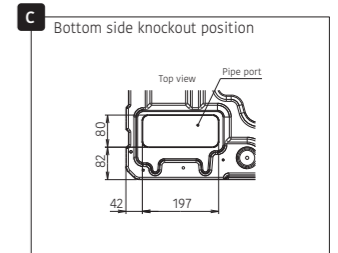
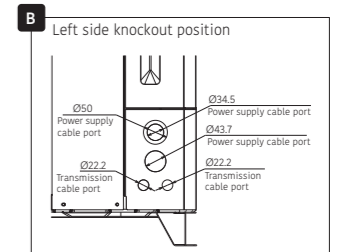
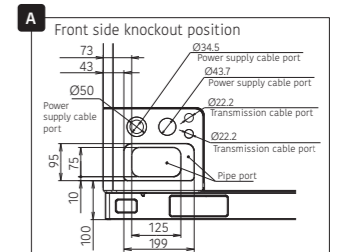
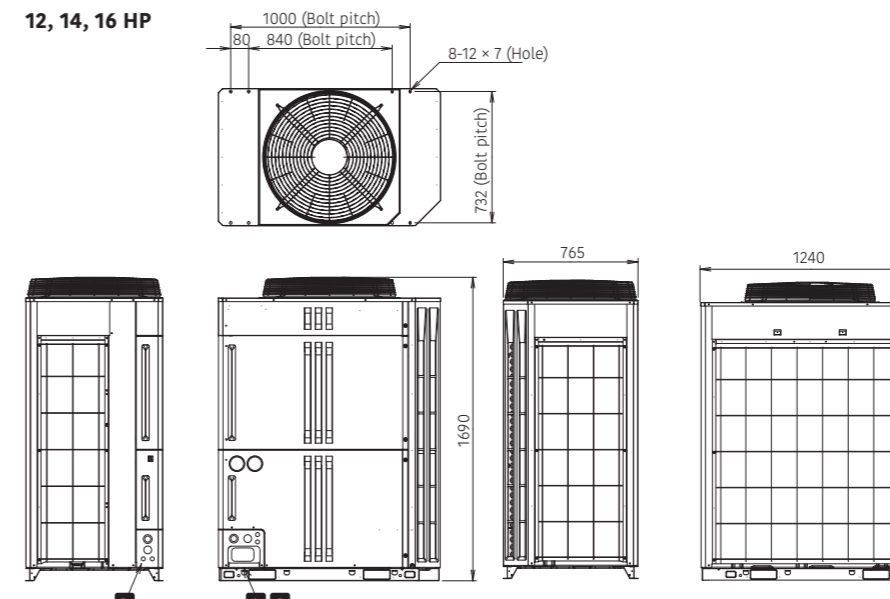

Outdoor unit specifications

Space saving combination

Rated capacity range		HP	8	10	12	14	16	18	20	22	24	26	28	30	32	34	36	38	40	42	44	46	48	
Model name			AJH072LALDH	AJH090LALDH	AJH108LALDH	AJH126LALDH	AJH144LALDH	AJH162LALDH	AJH180LALDH	AJH198LALDH	AJH216LALDH	AJH234LALDH	AJH252LALDH	AJH270LALDH	AJH288LALDH	AJH306LALDH	AJH324LALDH	AJH342LALDH	AJH360LALDH	AJH378LALDH	AJH396LALDH	AJH414LALDH	AJH432LALDH	
Unit 1			AJH072LALDH	AJH090LALDH	AJH108LALDH	AJH126LALDH	AJH144LALDH	AJH162LALDH	AJH180LALDH	AJH198LALDH	AJH216LALDH	AJH234LALDH	AJH252LALDH	AJH270LALDH	AJH288LALDH	AJH306LALDH	AJH324LALDH	AJH342LALDH	AJH360LALDH	AJH378LALDH	AJH396LALDH	AJH414LALDH	AJH432LALDH	
Unit 2			AJH072LALDH	AJH090LALDH	AJH108LALDH	AJH126LALDH	AJH144LALDH	AJH162LALDH	AJH180LALDH	AJH198LALDH	AJH216LALDH	AJH234LALDH	AJH252LALDH	AJH270LALDH	AJH288LALDH	AJH306LALDH	AJH324LALDH	AJH342LALDH	AJH360LALDH	AJH378LALDH	AJH396LALDH	AJH414LALDH	AJH432LALDH	
Unit 3			AJH072LALDH	AJH090LALDH	AJH108LALDH	AJH126LALDH	AJH144LALDH	AJH162LALDH	AJH180LALDH	AJH198LALDH	AJH216LALDH	AJH234LALDH	AJH252LALDH	AJH270LALDH	AJH288LALDH	AJH306LALDH	AJH324LALDH	AJH342LALDH	AJH360LALDH	AJH378LALDH	AJH396LALDH	AJH414LALDH	AJH432LALDH	
Maximum connectable indoor units*1			17	21	26	30	34	39	43	47	52	56	60	64	64	64	64	64	64	64	64	64	64	
Connectable capacity range of indoor units		kW	11.2 - 33.6	14.0 - 42.0	16.8 - 50.2	20.0 - 60.0	22.5 - 67.5	25.2 - 75.6	28.0 - 84.0	31.2 - 93.6	34.0 - 102.0	36.5 - 109.5	39.3 - 117.7	42.5 - 127.5	45.0 - 135.0	47.7 - 143.1	50.5 - 151.5	53.3 - 159.7	56.5 - 169.5	59.0 - 177.0	61.8 - 185.2	65.0 - 195.0	67.5 - 202.5	
Power source			3-phase, 4-wire, 400V, 50Hz												3-phase, 4-wire, 400V, 50Hz									
Capacity	Cooling	kW	22.4	28.0	33.5	40.0	45.0	50.4	56.0	62.4	68.0	73.0	78.5	85.0	90.0	95.4	101.0	106.5	113.0	118.0	123.5	130.0	135.0	
	Nominal Heating		22.4	28.0	33.5	40.0	45.0	50.4	56.0	62.4	68.0	73.0	78.5	85.0	90.0	95.4	101.0	106.5	113.0	118.0	123.5	130.0	135.0	
	Max. Heating		25.0	31.5	37.5	45.0	48.0	50.4	56.5	63.0	70.0	76.5	79.5	85.5	93.0	96.0	104.5	111.0	117.0	124.5	133.5	141.0	144.0	
Input power	Cooling	kW	5.95	9.06	9.54	13.18	16.74	15.01	18.12	19.13	22.24	25.80	26.28	29.92	33.48	31.75	34.86	35.34	38.98	42.54	43.02	46.66	50.22	
	Nominal Heating		5.42	7.44	7.76	11.74	13.76	12.86	14.88	17.16	19.18	21.20	21.52	25.12	27.52	26.62	28.64	28.96	32.94	34.96	35.28	39.26	41.28	
	Max. Heating		6.26	8.98	9.48	14.00	15.02	15.24	17.96	20.26	22.98	24.00	24.50	29.02	30.04	30.26	32.98	33.48	38.00	39.02	39.52	44.04	45.06	
EER	Cooling	W/W	3.76	3.09	3.51	3.03	2.68	3.36	3.09	3.26	3.06	2.83	2.99	2.84	2.69	3.00	2.90	3.01	2.90	2.77	2.87	2.79	2.69	
	Nominal Heating		4.13	3.76	4.31	3.41	3.27	3.92	3.76	3.64	3.55	3.44	3.65	3.33	3.27	3.58	3.53	3.68	3.43	3.38	3.50	3.31	3.27	
COP	Cooling	W/W	3.99	3.50	3.95	3.21	3.19	-	-	-	-	-	-	-	-	-	-	-	-	-	-	-	-	
	Max. Heating		7.09	6.65	7.33	6.77	6.23	6.87	6.65	6.93	6.71	6.44	6.78	6.50	6.23	6.66	6.51	6.74	6.55	6.37	6.60	6.41	6.23	
SEER	Cooling	W/W	3.63	3.64	3.97	3.86	3.95	3.64	3.64	3.75	3.75	3.80	3.96	3.91	3.95	3.74	3.74	3.85	3.82	3.85	3.96	3.92	3.95	
	Heating		280.6	263.0	290.2	267.8	246.2	271.8	263.0	274.2	265.4	254.6	268.2	257.0	246.2	263.3	257.4	266.5	259.0	251.8	260.9	253.4	246.2	
ηc	Cooling	%	142.2	142.6	155.8	154.4	155.0	142.6	146.8	147.0	148.8	155.4	153.2	155.0	146.6	146.7	151.1	149.7	150.9	155.3	153.8	155.0	155.0	
	Heating		11,100 / 11,100	11,100 / 11,100	13,000 / 13,000	13,000 / 13,000	13,700 / 13,700	11,100x2 / 11,100x2	11,100x2 / 11,100x2	13,000+11,100 / 13,000+11,100	13,000+11,100 / 13,000+11,100	13,700+11,100 / 13,700+11,100	13,700+11,100 / 13,700+11,100	13,700+11,100 / 13,700+11,100	13,700+11,100 / 13,700+11,100	13,700x2 / 13,700x2	13,700+11,100x2 / 13,700+11,100x2	13,700+11,100x2 / 13,700+11,100x2	13,700+11,100x2 / 13,700+11,100x2	13,700+11,100x2 / 13,700+11,100x2	13,700+11,100x2 / 13,700+11,100x2	13,700x2 / 13,700x2	13,700x2 / 13,700x2	13,700x2 / 13,700x2
Sound pressure level*2/ Power level	Cooling	dB(A)	58 / 79	58 / 79	58 / 81	62 / 84	63 / 86	61	61	63	63	64	64	66	66	67	67	68	69	69	69	69	70	
	Heating		59 / 80	60 / 81	60 / 83	64 / 85	65 / 87	63	63	65	65	66	66	68	68	67	67	68	68	69	69	69	70	
Max. External static pressure		Pa	82	82	82	82	82	82	82	82	82	82	82	82	82	82	82	82	82	82	82	82	82	
Compressor motor output		kW	7.5	7.5	11.0	11.0	11.0	7.5 × 2	7.5 × 2	11.0 × 7.5	11.0 × 7.5	11.0 × 7.5	11.0 × 7.5	11.0 × 2	11.0 × 2	11.0 × 2	11.0 × 2	11.0 × 2 + 7.5	11.0 × 2 + 7.5	11.0 × 2 + 7.5	11.0 × 3	11.0 × 3	11.0 × 3	
Heat exchanger fin			Blue fin	Blue fin	Blue fin	Blue fin	Blue fin	Blue fin	Blue fin	Blue fin	Blue fin	Blue fin	Blue fin	Blue fin	Blue fin	Blue fin	Blue fin	Blue fin	Blue fin	Blue fin	Blue fin	Blue fin	Blue fin	
Net Dimensions	Height	mm	1,690	1,690	1,690	1,690	1,690	1,690x2	1,690x2	1,690x2	1,690x2	1,690x2	1,690x2	1,690x2	1,690x2	1,690x3	1,690x3	1,690x3	1,690x3	1,690x3	1,690x3	1,690x3	1,690x3	
	Width		930	930	1,240	1,240	1,240	930x2	930x2	1,240+930	1,240+930	1,240+930	1,240+930	1,240x2	1,240x2	1,240x2	1,240+930x2	1,240+930x2	1,240x2	1,240x2	1,240x2	1,240x3	1,240x3	
	Depth		765	765	765	765	765	765x2	765x2	765x2	765x2	765x2	765x2	765x2	765x2	765x2	765x3	765x3	765x3	765x3	765x3	765x3	765x3	
Weight		kg	252	252	275	275	275	252 252	252 252	275 252	275 252	275 252	275 252	275 252	275 252	275 252 252	275 252 252	275 252 252	275 252 252	275 252 252	275 252 252	275 252 252	275 252 252	
Refrigerant	Type (Global Warming Potential)		R410A (2,088)	R410A (2,088)	R410A (2,088)	R410A (2,088)	R410A (2,088)	R410A (2,088)	R410A (2,088)	R410A (2,088)	R410A (2,088)	R410A (2,088)	R410A (2,088)	R410A (2,088)	R410A (2,088)	R410A (2,088)	R410A (2,088)	R410A (2,088)	R410A (2,088)	R410A (2,088)	R410A (2,088)	R410A (2,088)		
	Charge (CO2eq-T)	kg	11.7 (24.430)	11.7 (24.430)	11.8 (24.638)	11.8 (24.638)	11.8 (24.638)	11.7 × 2 (24.430 × 2)	11.7 × 2 (24.430 × 2)	11.8 + 11.7 (24.638 + 24.430)	11.8 + 11.7 (24.638 + 24.430)	11.8 × 2 (24.638 × 2)	11.8 × 2 (24.638 × 2)	11.8 × 2 (24.638 × 2)	11.8 × 2 (24.638 × 2)	11.8 × 2 (24.638 × 2)	11.8 × 2 (24.638 × 2)	11.8 × 2 (24.638 × 2)	11.8 × 2 (24.638 × 2)	11.8 × 2 (24.638 × 2)	11.8 × 3 (24.638 × 3)	11.8 × 3 (24.638 × 3)	11.8 × 3 (24.638 × 3)	
Connection pipe diameter	Liquid	mm	12.70	12.70	12.70	12.70	12.70	15.88	15.88	15.88	15.88	15.88	15.88	19.05	19.05	19.05	19.05	19.05	19.05	19.05	19.05	19.05	19.05	
	Gas		22.22	22.22	28.58	28.58	28.58	28.58	28.58	34.92	34.92	34.92	34.92	34.92	34.92	41.27	41.27	41.27	41.27	41.27	41.27	41.27	41.27	
Operating Range	Cooling	°CDB	-15 to 46	-15 to 46	-15 to 46	-15 to 46	-15 to 46	-15 to 46	-15 to 46	-15 to 46	-15 to 46	-15 to 46	-15 to 46	-15 to 46	-15 to 46	-15 to 46	-15 to 46	-15 to 46	-15 to 46	-15 to 46	-15 to 46	-15 to 46		
	Heating		-20 to 21	-20 to 21	-20 to 21	-20 to 21	-20 to 21	-20 to 21	-20 to 21	-20 to 21	-20 to 21	-20 to 21	-20 to 21	-20 to 21	-20 to 21	-20 to 21	-20 to 21	-20 to 21	-20 to 21	-20 to 21	-20 to 21	-20 to 21	-20 to 21	

Energy Efficiency Combination

Rated capacity range		HP	16	20	24	26	28	30	32	34	36	38	40	42	44		
Model name			AJH144LALDHH	AJH180LALDHH	AJH216LALDHH	AJH234LALDHH	AJH252LALDHH	AJH270LALDHH	AJH288LALDHH	AJH306LALDHH	AJH324LALDHH	AJH342LALDHH	AJH360LALDHH	AJH378LALDHH	AJH396LALDHH		
Unit 1			AJH072LALDH	AJH108LALDH	AJH072LALDH	AJH090LALDH	AJH108LALDH	AJH126LALDH	AJH108LALDH	AJH126LALDH	AJH108LALDH	AJH126LALDH	AJH126LALDH	AJH126LALDH	AJH144LALDH		
Unit 2			AJH072LALDH	AJH108LALDH	AJH072LALDH	AJH090LALDH	AJH108LALDH	AJH126LALDH	AJH108LALDH	AJH126LALDH	AJH108LALDH	AJH126LALDH	AJH126LALDH	AJH126LALDH	AJH144LALDH		
Unit 3			AJH072LALDH	AJH108LALDH	AJH072LALDH	AJH090LALDH	AJH108LALDH	AJH126LALDH	AJH108LALDH	AJH126LALDH	AJH108LALDH	AJH126LALDH	AJH126LALDH	AJH126LALDH	AJH144LALDH		
Maximum connectable indoor units*1			34	43	52	56	60	64	64	64	64	64	64	64			
Connectable capacity range of indoor units		kW	22.4 - 67.2	28.0 - 83.8	33.6 - 100.8	36.4 - 109.2	39.2 - 117.4	42.4 - 127.2	44.7 - 134.1	48.0 - 143.8	50.3 - 150.7	53.5 - 160.5	56.8 - 170.2	60.0 - 180.0	62.5 - 187.5		
Power source			3-phase, 4-wire, 400V, 50Hz								3-phase, 4-wire, 400V, 50Hz						
Capacity	Cooling	kW	44.8	55.9	67.2	72.8	78.3	84.8	89.4	95.9	100.5	107.0	113.5	120.0	125.0		
	Nominal Heating		44.8	55.9	67.2	72.8	78.3	84.8	89.4	95.9	100.5	107.0	113.5	120.0	125.0		
	Max. Heating		50.0	62.5	75.0	81.5	87.5	93.5	100.0	107.0	114.0	121.0	128.0	135.0	142.0		
Input power	Cooling	kW	11.90	15.49	17.85	20.96	21.44	25.08	25.03	28.67	28.62	32.26	35.90	39.54	43.18		
	Nominal Heating		10.84	13.18	16.26	18.28	18.60	22.58	20.94	24.92	23.28	27.26	31.24	35.22	37.24		
	Max. Heating		12.52	15.74	18.78	21.50	22.00	26.52	25.22	29.74	28.44	32.96	37.48	42.00	43.02		
EER	Cooling	W/W	3.76	3.61	3.76	3.47	3.65	3.38	3.57	3.34	3.51	3.32	3.16	3.03	2.90		
	Nominal Heating		4.13	4.24	4.13	3.98	4.21	3.98	4.27	3.76	3.85	4.32	3.93	3.63	3.41		



## VRF R410A INDOOR UNITS

5 types and 95 models available to meet the requirements of any building design.

Indoor units for the VRF Systems are compact, highly efficient, quiet, and user-friendly. General offers a variety of types and capacities for its indoor units that are easy to install and maintain. In addition, a variety of optional parts are available to provide an even more desirable air conditioning experience to users.

V-100 VRF Indoor Unit Lineup for J-IVS, J-IV, J-IVL, VR-IV, V-IV

### Cassette

- V-102 Compact type
- V-104 Circular Flow Range - Slim type
- V-106 Circular Flow Range - Large type
- V-108 1-way Flow
- V-110 3D Flow

### Duct

- V-112 Low Static Pressure Duct Mini Duct
- V-114 Low Static Pressure Duct Slim Duct/Slim Concealed Floor
- V-116 Low Static Pressure Duct
- V-118 Medium Static Pressure Duct
- V-120 High Static Pressure Duct

### Floor, Ceiling

- V-122 Compact Floor
- V-124 Floor/Ceiling
- V-126 Ceiling

### Wall-Mounted

- V-128 Wall-Mounted (EEV Internal/external)



# VRF R410A Indoor Unit Lineup for J-IVS J-IV J-IVL VR-IV V-IV

Capacity range (kW)		1.1	2.2	2.8	3.6	4.0	4.5	5.6	7.1	9.0	10.0	11.2	12.5	14.0	18.0	22.4	25.0	28.0		
Class		4	7	9	12	14	14	18	24	30	34	36	45	54	60	72	90	96		
Cassette	Compact 4-way Flow		AUXB 004 GLEH	AUXB 007 GLEH	AUXB 009 GLEH	AUXB 012 GLEH		AUXB 014 GLEH	AUXB 018 GLEH	AUXB 024 GLEH										
	Circular Flow	Slim type							AUXM 018 GLEH	AUXM 024 GLEH	AUXM 030 GLEH									
		Large type							AUXK 018 GLEH	AUXK 024 GLEH	AUXK 030 GLEH	AUXK 034 GLEH	AUXK 036 GLEH	AUXK 045 GLEH	AUXK 054 GLEH					
	1-way Flow	 004 - 012    014 - 024	AUXV 004 GLEH	AUXV 007 GLEH	AUXV 009 GLEH	AUXV 012 GLEH		AUXV 014 GLEH	AUXV 018 GLEH	AUXV 024 GLEH										
	3D Flow								AUXS 018 GLEH	AUXS 024 GLEH										
Duct	Mini Duct	 004 - 014    018    024	ARXK 004 GLGH	ARXK 007 GLGH	ARXK 009 GLGH	ARXK 012 GLGH		ARXK 014 GLGH	ARXK 018 GLGH	ARXK 024 GLGH										
	Slim Duct	 04/007 - 014    018    024	ARXD 04 GALH*2	ARXD 007 GLEH	ARXD 009 GLEH	ARXD 012 GLEH		ARXD 014 GLEH	ARXD 018 GLEH	ARXD 024 GLEH										
	Low Static Pressure High Efficiency*3								ARXP 018 GLFH		ARXP 030 GLFH									
	Medium static pressure									ARXA 024 GLEH	ARXA 030 GLEH		ARXA 036 GLEH	ARXA 045 GLEH						
	High Static Pressure	 036/45 - 60    072 - 090    096											ARXC 036 GTEH	ARXC 045 GTEH		ARXC 060 GTEH*1	ARXC 072 GTEH*1	ARXC 090 GTEH*1	ARXC 096 GTEH*1	
Floor	Standard (*Same as Ceiling models)					ABHA 012 GTEH		ABHA 014 GTEH	ABHA 018 GTEH	ABHA 024 GTEH										
	Slim Concealed Floor (*Same as Slim Duct models)	 04/007 - 014    018    024	ARXD 04 GALH*2	ARXD 007 GLEH	ARXD 009 GLEH	ARXD 012 GLEH		ARXD 014 GLEH	ARXD 018 GLEH	ARXD 024 GLEH										
	Compact	EEV Internal		AGHA 004 GCGH	AGHA 007 GCGH	AGHA 009 GCGH	AGHA 012 GCGH		AGHA 014 GCGH											
		EEV External		AGHE 004 GCEH	AGHE 007 GCEH	AGHE 009 GCEH	AGHE 012 GCEH		AGHE 014 GCEH											
Ceiling	 012 - 024    030 - 054				ABHA 012 GTEH		ABHA 014 GTEH	ABHA 018 GTEH	ABHA 024 GTEH	ABHA 030 GTEH		ABHA 036 GTEH	ABHA 045 GTEH	ABHA 054 GTEH						
Wall-Mounted	EEV Internal	 004 - 014    18 - 24    030 - 034	ASHA 004 GCGH	ASHA 007 GCGH	ASHA 009 GCGH	ASHA 012 GCGH		ASHA 014 GCGH	ASHA 18 GBCH	ASHA 24 GBCH	ASHA 030 GTEH	ASHA 034 GTEH								
	EEV External	 004 - 014	ASHE 004 GCEH	ASHE 007 GCEH	ASHE 009 GCEH	ASHE 012 GCEH		ASHE 014 GCEH												

\*1: ARXC060/072/090/096G cannot be connected to J-IVS/J-IV series.  
 \*2: ARXD04GALH cannot be connected to J-IVS/J-IV/J-IVL/VR-IV series.  
 \*3: Production by order  
 Specifications and design are subject to change without notice.

# Cassette

Compact 4-way Flow



## Compact and Stylish Panel

The compact and stylish panel fits nicely into a grid type ceiling. The linear design is a perfect fit into a grid of 620 mm x 620 mm in the ceiling.

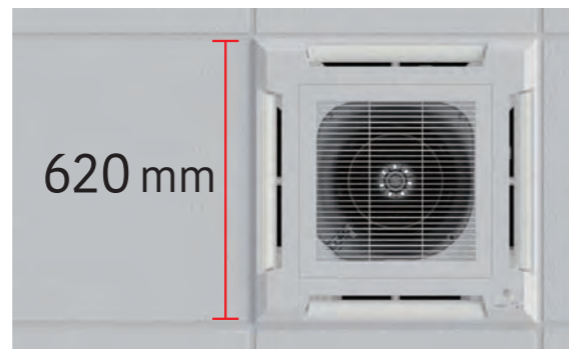

## Easy Maintenance

You can access the unit for maintenance just by removing a ceiling panel right next to the grille. As no inspection hole needs to be cut through the ceiling, no additional construction cost is incurred.



The air inlet grille can be installed to open in any direction for easy maintenance.



## Flexible Maintenance

The unit fits nicely into the decor of a grid type ceiling and can be installed near a lighting or a ventilation opening.



## High Ceiling Mode

The cassette can be installed up to a height of 3.0 m. (012/014/018/024).

Model code	Maximum height from floor to ceiling (m)	
	Standard mode	High ceiling mode
004	2.7	-
007	2.7	-
009	2.7	-
012	2.7	3.0
014	2.7	3.0
018	2.7	3.0
024	2.7	3.0

Model: AUXB004GLEH / AUXB007GLEH / AUXB009GLEH  
 AUXB012GLEH / AUXB014GLEH / AUXB018GLEH  
 AUXB024GLEH



## Specifications

Model name		AUXB004GLEH	AUXB007GLEH	AUXB009GLEH	AUXB012GLEH	AUXB014GLEH	AUXB018GLEH	AUXB024GLEH
Power source		Single phase, 220-240V~, 50Hz						
Capacity	Cooling	1.1	2.2	2.8	3.6	4.5	5.6	7.1
	Heating	1.3	2.8	3.2	4.1	5.0	6.3	8.0
Input power		23	25	25	29	35	36	84
Airflow rate	High	530/530	540	550	600	680	710	1,030
	Med-High	490/480	500	520	560	620	660	910
	Med	450/430	460	480	520	560	590	790
	Med-Low	420/380	420	440	480	500	520	680
	Low	390/340	390	400	430	440	460	560
	Quiet	350/300	350	350	390	390	400	450
Sound pressure level	High	34/34	34	35	37	38	41	50
	Med-High	32/31	32	33	34	37	39	46
	Med	30/29	30	31	33	34	36	43
	Med-Low	28/26	28	29	31	32	33	39
	Low	27/24	27	27	29	30	30	35
	Quiet	25/21	25	25	27	27	27	30
Net Dimensions (H x W x D)		245 x 570 x 570	245 x 570 x 570	245 x 570 x 570	245 x 570 x 570	245 x 570 x 570	245 x 570 x 570	245 x 570 x 570
Weight		14.5	15	15	15	15	17	17
Connection pipe diameter	Liquid (Flare)	6.35	6.35	6.35	6.35	6.35	6.35	9.52
	Gas (Flare)	9.52	9.52	9.52	12.70	12.70	12.70	15.88
Drain Hose Diameter (I.D./O.D.)		25/32						
Cassette Grille	Model name	UTG-UFGE-W/UTG-UFGC-W						
	Net Dimensions (H x W x D)	49 x 620 x 620/50 x 700 x 700						
	Weight	2.3/2.6						

Note: Specifications are subject to the following conditions:  
 Cooling: Indoor temperature of 27°CDB/19°CWB, and outdoor temperature of 35°CDB/24°CWB.  
 Heating: Indoor temperature of 20°CDB/(15°CWB), and outdoor temperature of 7°CDB/6°CWB.  
 Pipe length: 7.5 m; Height difference between outdoor unit and indoor unit: 0 m. Voltage: 230 [V]  
 \*1: This value is under cooling operation.

## Optional parts

\*For more details, please refer to the chapter "Control System List" and "Optional Parts List."

Air Outlet Shutter Plate:	UTR-YDZB	Cassette Grille:	UTG-UFGE-W, UTG-UFGC-W
Fresh Air Intake Kit:	UTZ-VXAA	External power supply unit:	UTZ-GXXA, UTZ-GXXC, UTZ-GXXD
Insulation Kit for high humidity:	UTZ-KXGC	Remote Sensor Kit:	UTY-XSZXZ1
Silver Ion Filter:	UTD-HFAA		

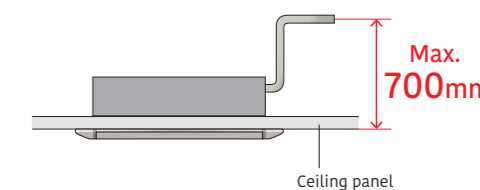

## Dimensions

(Unit: mm)

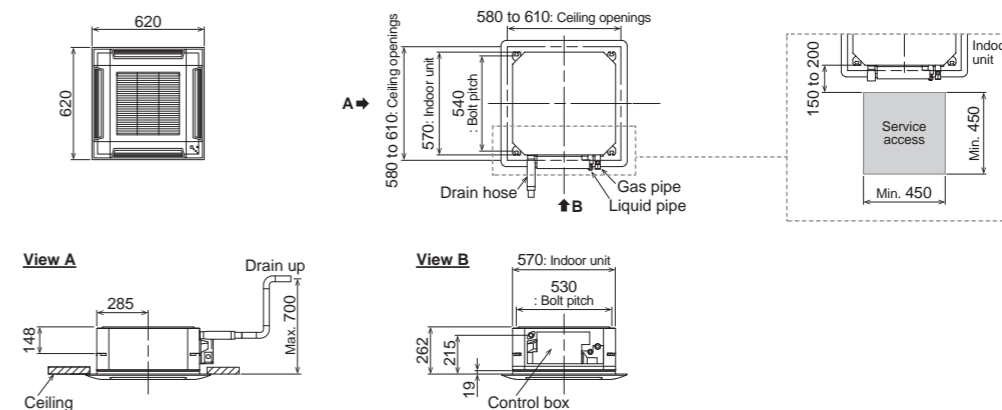

# Cassette

Circular Flow  
Slim



## Unique Circular Flow Design

This Cassette type air conditioner is equipped with a high performance DC fan motor, a turbo fan, and a louver to propel powerful airflows in all directions.

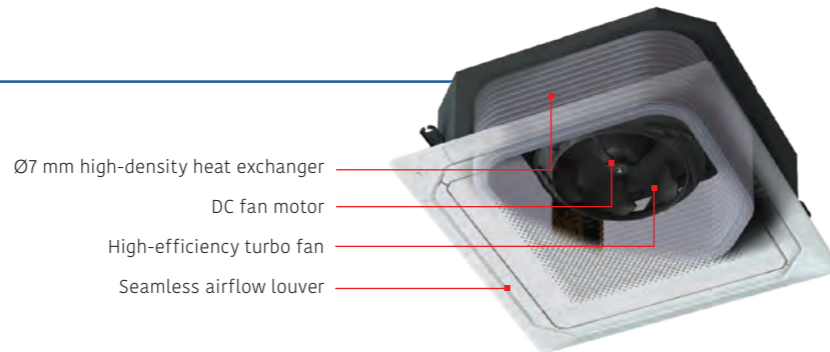

## Uniform Temperature Air Conditioning

Achieve a comfortable air conditioning spread to every corner of the room thanks to the circular flow and wide vertical airflow.

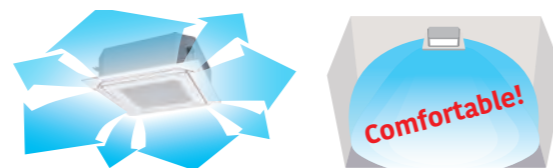

## Individual Louver Control

Each louver can be set individually by the Touch panel wired remote controller so the user can enjoy the comfort of different directional airflows according to the room layout.

\* UTY-RNRGZ6 / UTY-DCGGZ4 / UTY-RVRG only



Comfortable air conditioning by preventing direct blowing of cold air and by providing swinging air flow simultaneously.

Provides efficient air conditioning based on the room layout

## The Occupancy Sensor Contributes to Further Energy Savings

Energy saving operation starts automatically by detecting the motion of a person. Two modes of save operation mode and stop mode can be selected.

\* UTY-RNRGZ6 / UTY-DCGGZ4 / UTY-RVRG only



Occupancy sensor (Optional)

2 modes are available to choose from:

- Auto economy mode** The air conditioner switches to operate on reduced power when it detects that the room is unoccupied.
- Auto-off mode** The air conditioner stops operating when it detects that the room is unoccupied.

Model: AUXM018GLEH / AUXM024GLEH / AUXM030GLEH



## Specifications

Model name		AUXM018GLEH	AUXM024GLEH	AUXM030GLEH
Power source		Single phase, 220-240V~, 50Hz		
Capacity	Cooling	5.6	7.1	9.0
	Heating	6.3	8.0	10.0
Input power		20	25	49
Airflow rate	High	1,050	1,120	1,470
	Med-High	930	1,050	1,160
	Med	900	930	1,070
	Med-Low	870	900	930
	Low	810	870	900
	Quiet	780	780	780
Sound pressure level	High	33	35	40
	Med-High	32	33	36
	Med	31	32	34
	Med-Low	30	31	32
	Low	29	30	31
	Quiet	28	28	28
Dimensions (H × W × D)		mm 246 × 840 × 840		
Weight		kg 24.0	24.5	24.5
Connection pipe diameter	Liquid (Flare)	6.35	9.52	9.52
	Gas (Flare)	12.70	15.88	15.88
Drain Hose Diameter (I.D./O.D.)		25/32		
Cassette Grille	Model name	UTG-UKGC-W/UTG-UKGA-B		
	Dimensions (H × W × D)	mm 53 × 950 × 950		
	Weight	kg 6.0		

Note: Specifications are subject to the following conditions:  
 Cooling: Indoor temperature of 27°CDB/19°CWB, and outdoor temperature of 35°CDB/24°CWB.  
 Heating: Indoor temperature of 20°CDB/(15°CWB), and outdoor temperature of 7°CDB/6°CWB.  
 Pipe length: 7.5 m; Height difference between outdoor unit and indoor unit: 0 m. Voltage: 230 [V].  
 When AUX\*018GLEH is connected to an outdoor unit other than one of the J-IVL series, the pipe diameter should be Ø9.52/Ø15.88 mm (Liquid/Gas).  
 When connecting AUXK036GLEH, AUXK045GLEH, and AUXK054GLEH to an outdoor unit other than the outdoor unit of the J-IVL series, the gas pipe diameter should be Ø19.05 mm.

## Optional parts

\*For more details, please refer to the chapter "Control System List" and "Optional Parts List."

Occupancy Sensor Kit: UTY-SHZXC	Air Outlet Shutter Plate: UTR-YDZK	Silver Ion Filter: UTD-HFRA
Wide Panel: UTG-AKXA-W	Insulation Kit for high humidity: UTZ-KXRA	Remote Sensor Kit: UTY-XSZXZ1
Panel Spacer: UTG-BKXA-W	Cassette Grille: UTG-UKGC-W, UTG-UKGA-B	External power supply unit: UTZ-GXXA, UTZ-GXXC, UTZ-GXXD
Fresh Air Intake Kit: UTZ-VXRA		

## Dimensions

(Unit: mm)

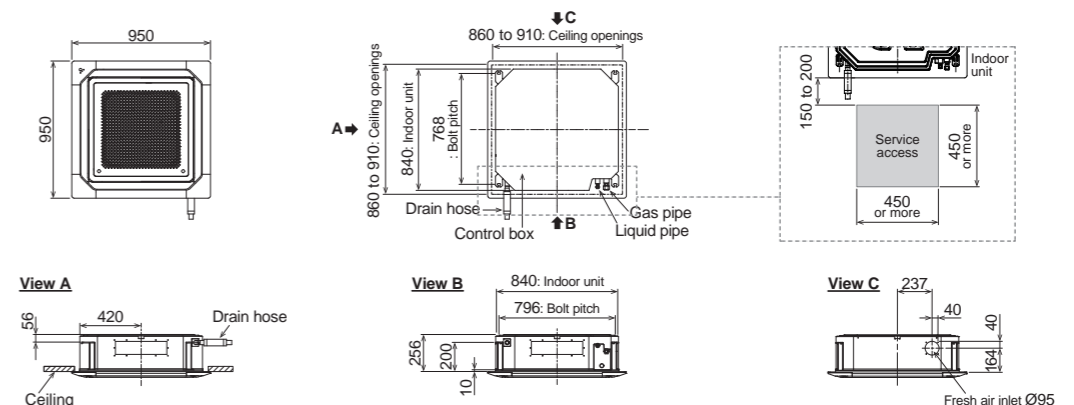

# Cassette

## Circular Flow

### Large



### Unique Circular Flow Design

This Cassette type air conditioner is equipped with a high performance DC fan motor, a turbo fan, and a louver to propel powerful airflows in all directions.

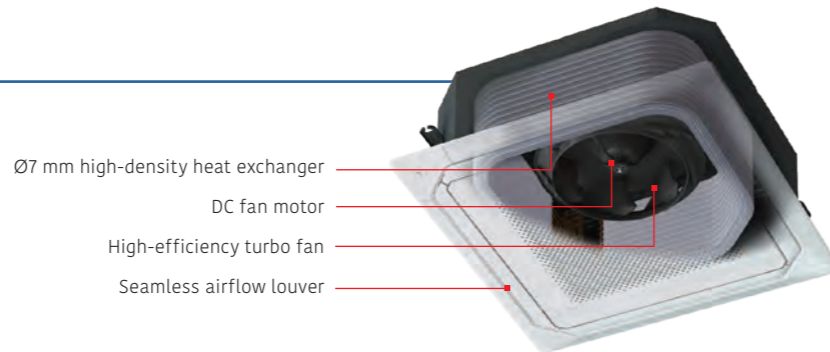

### Uniform Temperature Air Conditioning

Achieve a comfortable air conditioning spread to every corner of the room thanks to the circular flow and wide vertical airflow.

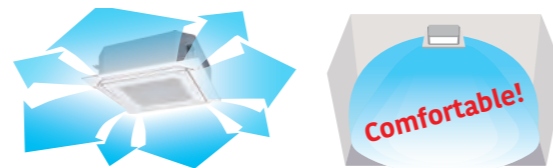

### Individual Louver Control

Each louver can be set individually by the Touch panel wired remote controller so the user can enjoy the comfort of different directional airflows according to the room layout.

\* UTY-RNRGZ6 / UTY-DCGGZ4 / UTY-RVRG only



Comfortable air conditioning by preventing direct blowing of cold air and by providing swinging air flow simultaneously.

Provides efficient air conditioning based on the room layout

### The Occupancy Sensor Contributes to Further Energy Savings

Energy saving operation starts automatically by detecting the motion of a person. Two modes of save operation mode and stop mode can be selected.

\* UTY-RNRGZ6 / UTY-DCGGZ4 / UTY-RVRG only



Occupancy sensor (Optional)

2 modes are available to choose from:

- Auto economy mode** The air conditioner switches to operate on reduced power when it detects that the room is unoccupied.
- Auto-off mode** The air conditioner stops operating when it detects that the room is unoccupied.

**Model: AUXK018GLEH / AUXK024GLEH / AUXK030GLEH  
AUXK034GLEH / AUXK036GLEH / AUXK045GLEH  
AUXK054GLEH**



### Specifications

Model name	AUXK018GLEH	AUXK024GLEH	AUXK030GLEH	AUXK034GLEH	AUXK036GLEH	AUXK045GLEH	AUXK054GLEH
Power source	Single phase, 220-240V~, 50Hz						
Capacity	Cooling	5.6	7.1	9.0	10.0	11.2	12.5
	Heating	6.3	8.0	10.0	11.2	12.5	14.0
Input power	W	40	40	47	47	61	89
Airflow rate	High	1,420	1,420	1,440	1,440	1,620	1,820
	Med-High	1,360	1,360	1,400	1,400	1,500	1,590
	Med	1,300	1,300	1,340	1,340	1,400	1,500
	Med-Low	1,270	1,270	1,300	1,300	1,340	1,400
	Low	1,200	1,200	1,280	1,280	1,280	1,300
Sound pressure level	Quiet	1,150	1,150	1,150	1,150	1,150	1,150
	High	38	38	39	39	41	44
	Med-High	37	37	38	38	40	42
	Med	36	36	37	37	38	40
	Med-Low	35	35	36	36	37	38
Low	34	34	35	35	36	36	
Quiet	33	33	33	33	33	33	
Dimensions (H × W × D)	mm 288 × 840 × 840						
Weight	kg	26.5	26.5	29.5	29.5	29.5	29.5
Connection pipe diameter	Liquid (Flare)	6.35	9.52	9.52	9.52	9.52	9.52
	Gas (Flare)	12.70	15.88	15.88	15.88	15.88	15.88
Drain Hose Diameter (I.D./O.D.)	25/32						
Cassette Grille	Model name	UTG-UKGC-W/UTG-UKGA-B					
	Dimensions (H × W × D)	mm 53 × 950 × 950					
	Weight	kg 6.0					

Note: Specifications are subject to the following conditions:  
Cooling: Indoor temperature of 27°CDB/19°CWB, and outdoor temperature of 35°CDB/24°CWB.  
Heating: Indoor temperature of 20°CDB/(15°CWB), and outdoor temperature of 7°CDB/6°CWB.  
Pipe length: 7.5 m; Height difference between outdoor unit and indoor unit: 0 m. Voltage: 230 [V].  
When AUX\*018GLEH is connected to an outdoor unit other than one of the J-IVL series, the pipe diameter should be Ø9.52/Ø15.88 mm (Liquid/Gas).  
When connecting AUXK036GLEH, AUXK045GLEH, and AUXK054GLEH to an outdoor unit other than the outdoor unit of the J-IVL series, the gas pipe diameter should be Ø19.05 mm.

### Optional parts

\*For more details, please refer to the chapter "Control System List" and "Optional Parts List."

Occupancy Sensor Kit: UTY-SHZXC	Air Outlet Shutter Plate: UTR-YDZK	Silver Ion Filter: UTD-HFRA
Wide Panel: UTG-AKXA-W	Insulation Kit for high humidity: UTZ-KXRA	Remote Sensor Kit: UTY-XSZXZ1
Panel Spacer: UTG-BKXA-W	Cassette Grille: UTG-UKGC-W, UTG-UKGA-B	External power supply unit: UTZ-GXXA, UTZ-GXXC, UTZ-GXXD
Fresh Air Intake Kit: UTZ-VXRA		

### Dimensions

(Unit: mm)

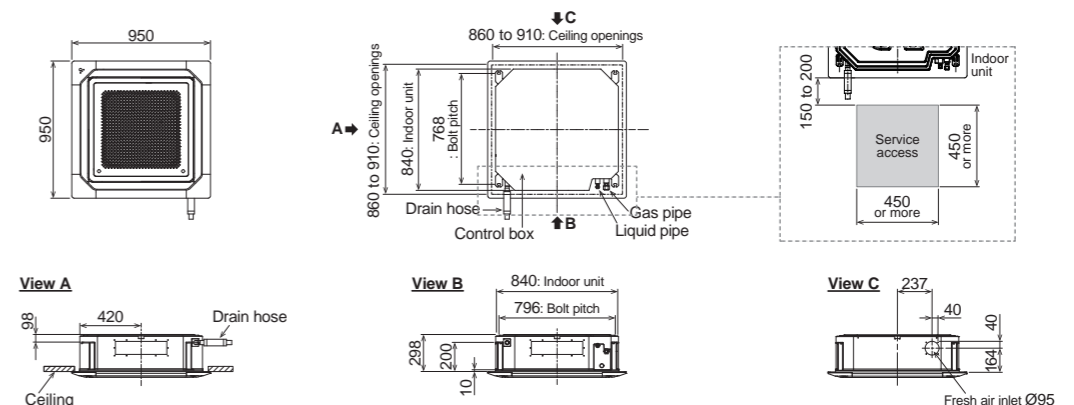

# Cassette

## 1-way Flow



### Compact Chassis Size

The compact size allows easy installation in a variety of commercial facilities and environments.

- The height of the chassis is less than 200 mm for all models.
- All 4 to 12 kBtu models are less than 1,000 mm wide.
- The depth of the chassis is 570 mm, which fits nicely into a grid type ceiling.

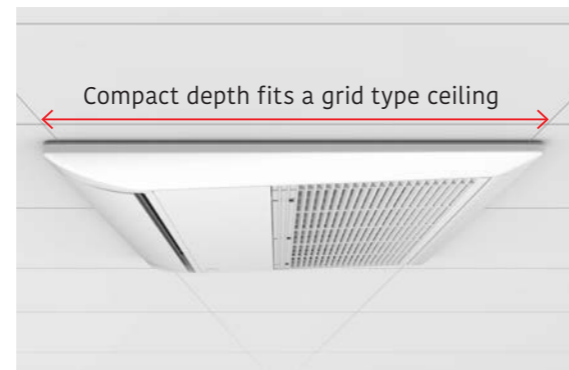

Dimensions (Panel size) (Unit: mm)

	4	7	9	12	14	18	24
H		198 (43)				198 (43)	
W		785 (950)				1,190 (1,360)	
D		570 (620)				570 (620)	

### Wide Airflow Range

A large flap with a wide range of movements, equipped with louvers arranged triangularly, sends air into every corner of the room.

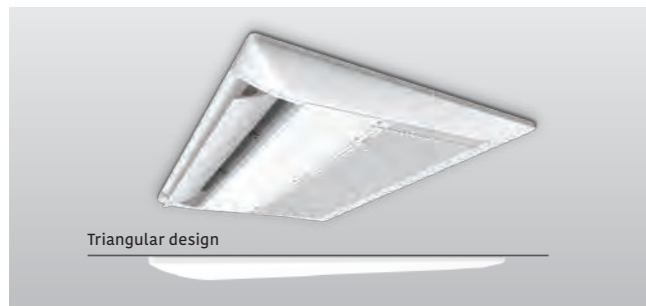

In cooling mode, the left/right airflow reaches every corner of the room without directly touching the human body to provide comfortable air conditioning.

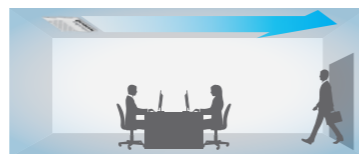

In heating mode, warm air is directed downward toward the floor to warm the feet and lower body, while the head is kept relatively cool.

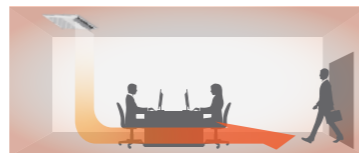

Note: This is a conceptual drawing. The performance of an air conditioner may vary depending on where it is installed, the size of the room, and its distance from the wall.

### Quiet Mode

The low operating noise makes the model ideal for use in hotel rooms.



Model: AUXV004GLEH / AUXV007GLEH / AUXV009GLEH  
 AUXV012GLEH / AUXV014GLEH / AUXV018GLEH  
 AUXV024GLEH



AUXV004/007/009/012GLEH



AUXV014/018/024GLEH

### Specifications

Model name		AUXV004GLEH	AUXV007GLEH	AUXV009GLEH	AUXV012GLEH	AUXV014GLEH	AUXV018GLEH	AUXV024GLEH
Power source		Single phase, 220-240V~, 50Hz						
Capacity	Cooling	1.1	2.2	2.8	3.6	4.5	5.6	7.1
	Heating	1.3	2.8	3.2	4.0	5.0	6.3	8.0
Input power		30/30	42/42	42/42	60/60	38/38	56/56	99/99
Airflow rate*	High	460	550	550	670	720	890	1,150
	Med-High	440	440	440	520	660	840	1,020
	Med	420	420	420	480	630	770	940
	Med-Low	400	400	400	450	600	710	790
	Low	380	380	380	410	580	660	700
	Quiet	360	360	360	360	550	580	610
Sound pressure level*	High	38	42	42	45	37	44	49
	Med-High	37	37	37	41	36	43	47
	Med	36	36	36	39	35	40	45
	Med-Low	35	35	35	38	34	38	42
	Low	33	33	33	36	33	36	39
	Quiet	32	32	32	32	32	34	36
Net Dimensions (H × W × D)		mm 198 × 785 × 570	198 × 785 × 570	198 × 785 × 570	198 × 785 × 570	198 × 1,190 × 570	198 × 1,190 × 570	198 × 1,190 × 570
Weight		kg 18	19	19	19	26	26	27
Connection pipe diameter	Liquid (Flare)	6.35	6.35	6.35	6.35	6.35	6.35	9.52
	Gas (Flare)	9.52	9.52	9.52	12.70	12.70	12.70	15.88
Drain Hose Diameter (I.D./O.D.)					25/32			
Cassette Grille	Model name	UTG-UNGA-W			UTG-UNGB-W			
	Net Dimensions (H × W × D)	mm 43 × 950 × 620			43 × 1,360 × 620			
	Weight	kg 6.5			8.5			

Note: Specifications are subject to the following conditions:  
 Cooling: Indoor temperature of 27°CDB/19°CWB, and outdoor temperature of 35°CDB/24°CWB.  
 Heating: Indoor temperature of 20°CDB/(15°CWB), and outdoor temperature of 7°CDB/6°CWB.  
 Pipe length: 7.5 m; Height difference between outdoor unit and indoor unit: 0 m. Voltage: 230 [V]

### Optional parts

- Cassette Grille: UTG-UNGA-W (004-012), UTG-UNGB-W (014-024)
- External power supply unit: UTZ-GXXA, UTZ-GXXC, UTZ-GXXD
- Remote sensor kit: UTY-XSZXZ1

### Flexible Installation

The L-shaped pipe kit allows for more flexible installation. Equipped with a built-in drain pump as standard, which enables a maximum pipe height difference of 700 m from the ceiling.

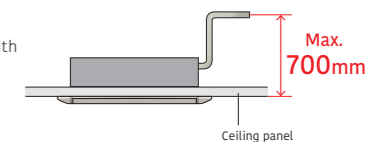

### Dimensions

(Unit: mm)

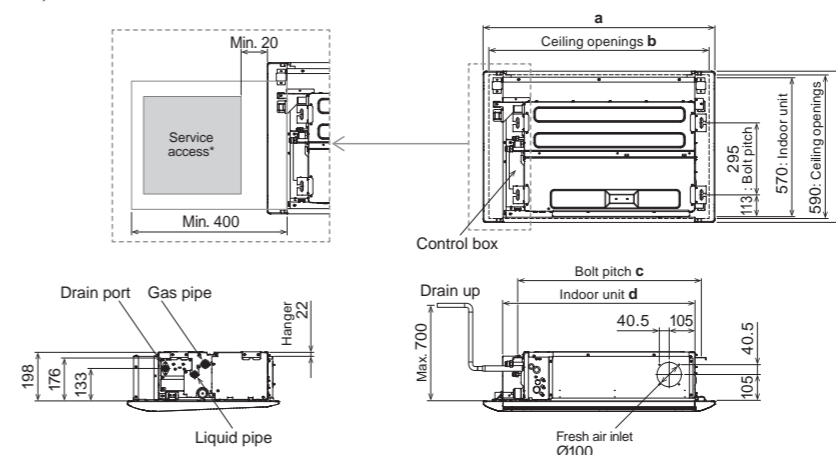

	AUXV 004 / 007 / 009 / 012 GLEH	AUXV 014 / 018 / 024 GLEH
a	950	1,360
b	920	1,330
c	752	1,152
d	785	1,190

\*The design of the service access depends on the installation method. Refer to the installation manual for more information.

# Cassette

## 3D Flow



Model: AUXS018GLEH / AUXS024GLEH



### 3 Individually Controlled Air Outlet Ports

The Comfortable airflow setting enables the left and right air outlet ports as well as the wide center port to work together to provide a comfortable room environment.

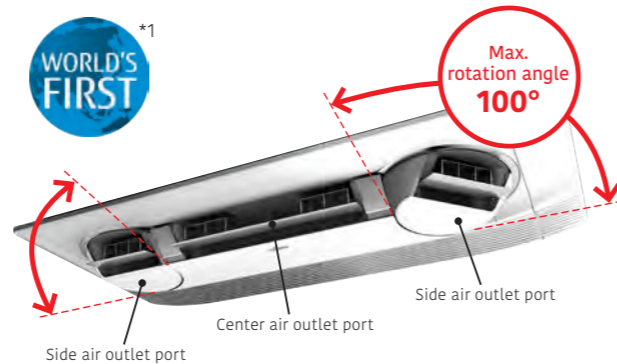

\*1: Announced 2018. In the category of room air conditioners for the home (source: General Inc.).

#### Temperature distribution during cooling and heating (when set to Comfortable airflow)



**Testing conditions:** Model AUXS024GLEH running cooling operation with the air volume set to "Hi" to maintain the room temperature at 18°C with the outdoor temperature at 35°C, tested in our 40m<sup>2</sup> environmental test room

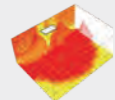

**Testing conditions:** Model AUXS024GLEH running heating operation with the air volume set to "Hi" to maintain the room temperature at 30°C with the outdoor temperature at 7°C, tested in our 40m<sup>2</sup> environmental test room

### Individual Airflow Setting

The individual airflow setting function optimizes the airflow direction to match the room layout.

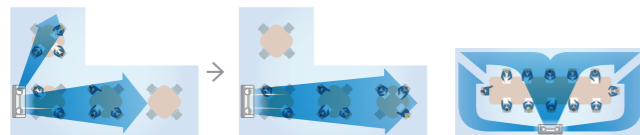

Adjusts airflows from the side air outlet ports to match the layout and usage of the room to minimize the amount of wasted airflow.

The airflow is optimally controlled to provide improved comfort in a narrow room.

#### Individual control of air outlet ports

Individual airflow can be set using a Wired remote controller with touch panel, Design type and Central remote controller\*. The airflow from each air outlet port can be set individually.



\* Feature available only on UTY-RNRGZ6 Wired remote controller with touch panel and UTY-DCGGZ4 Central remote controller

### High Energy Saving

The structural design to take in a larger volume of air and blow air out more smoothly reduces air blowing loss and achieves class-leading energy-saving performance.

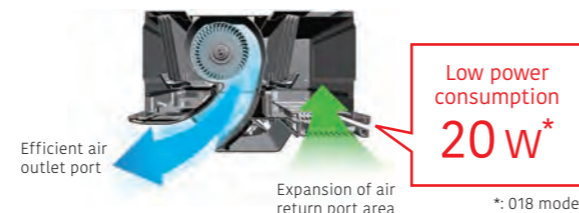

\*: 018 model

### Specifications

Model name		AUXS018GLEH		AUXS024GLEH	
Power source		Single phase, 220-240V~, 50Hz			
Capacity	Cooling	5.60		7.10	
	Heating	6.30		8.00	
Input power		20/28		34/43	
Airflow rate*	High	750/870		950/1,040	
	Med-High	710/830		890/990	
	Med	690/780		860/930	
	Med-Low	660/740		810/880	
	Low	630/700		770/840	
	Quiet	540/540		540/540	
Sound pressure level*	High	38/41		43/46	
	Med-High	36/40		42/45	
	Med	35/39		41/43	
	Med-Low	35/37		40/42	
	Low	33/36		38/40	
	Quiet	29/29		29/29	
Net Dimensions (H × W × D)		mm 200 × 1,240 × 500		mm 200 × 1,240 × 500	
Weight		kg 25		kg 25	
Connection pipe diameter	Liquid (Flare)	6.35		9.52	
	Gas (Flare)	12.70		15.88	
Drain Hose Diameter (I.D./O.D.)				25/32	
Cassette Grille	Model name	UTG-USGA-W			
	Net Dimensions (H × W × D)	mm 85 × 1,350 × 580			
	Weight	kg 11.5			

Note: Specifications are subject to the following conditions:  
 Cooling: Indoor temperature of 27°CDB/19°CWB, and outdoor temperature of 35°CDB/24°CWB.  
 Heating: Indoor temperature of 20°CDB/(15°CWB), and outdoor temperature of 7°CDB/6°CWB.  
 Pipe length: 7.5 m; Height difference between outdoor unit and indoor unit: 0 m. Voltage: 230 [V]  
 \*: Applicable to cooling and heating operation

### Optional parts

\*For more details, please refer to the chapter "Control System List" and "Optional Parts List."

- Remote sensor kit: UTY-XSZXZ1
- Cassette Grille: UTG-USGA-W
- External power supply unit: UTZ-GXXA, UTZ-GXXC, UTZ-GXXD

### Dimensions

(Unit: mm)

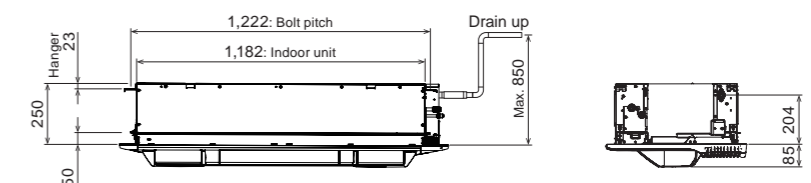
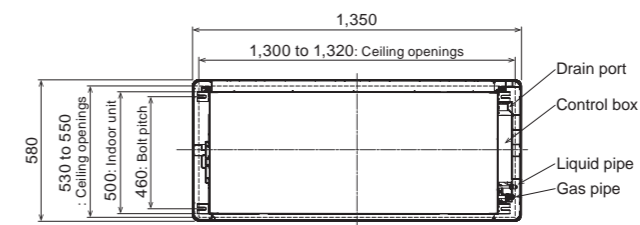

# Mini Duct

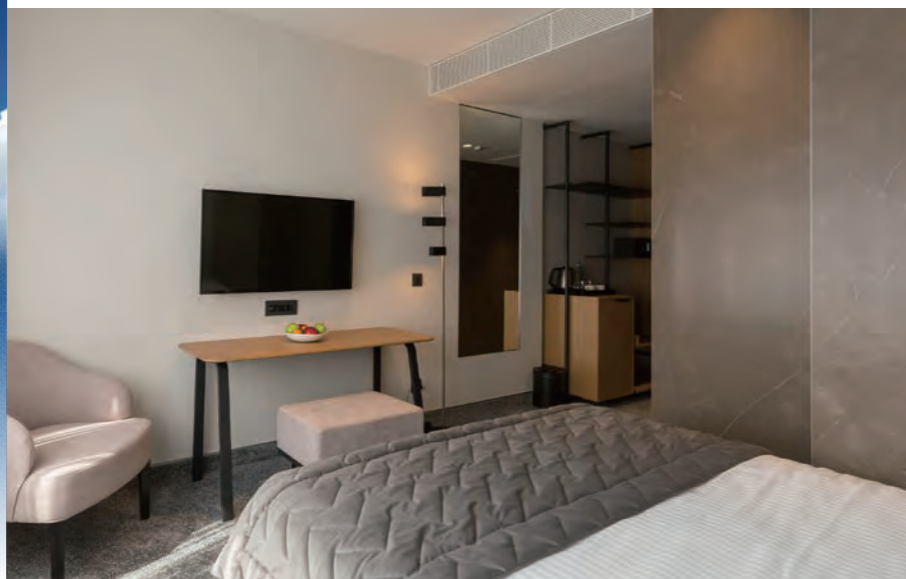

## Space Saving Design

- Fits into a space 198 mm high and 450 mm deep
- 30% smaller than previous-generation models
- Weighs 16 kg, 10% lighter

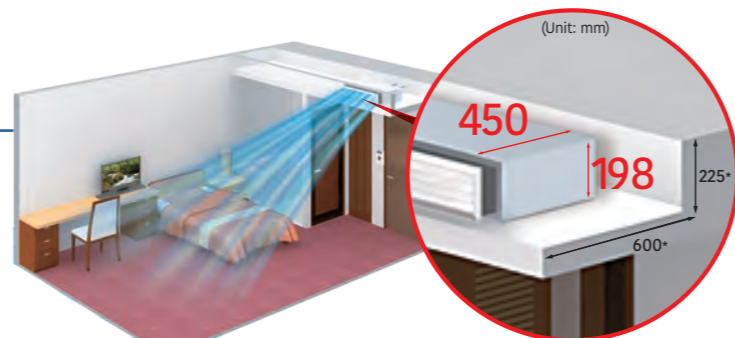

\*: Minimum clearance requirement

## Optimum Airflow Path and Low Noise Operation

The stabilized airflow reduces the noise level significantly.

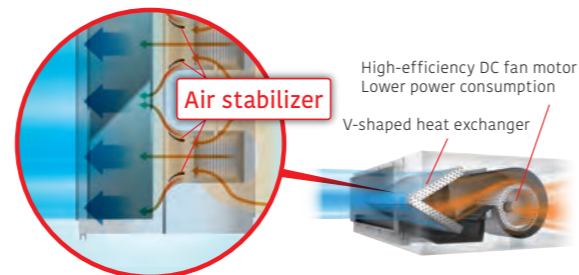

## 6-Speed Control\*

Multistep airflow adjustment allows installation in a quiet location.

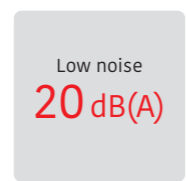

at 04 model

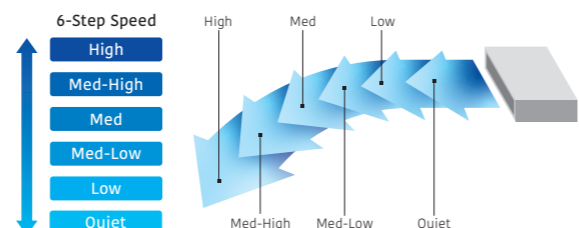

\* Remote controller is compatible with the following:  
 UTY-RVRG / UTY-RNRG26 / UTY-RLRG / UTY-RSRG21 / UTY-RHRG21 / UTY-DCGG24 /  
 UTY-ALGX21 / UTY-APGX21

## Easy to Design and Maintain for Drain

Indoor unit design for easy maintenance. Parts can be replaced from the side of the unit where maintenance is easier.

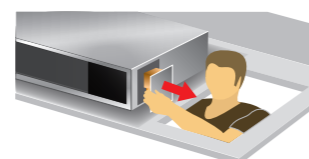

A drain pump is built into the unit as standard:  
 Parts can be accessed and replaced through the side of the unit for easy maintenance.

Model: ARXK004GLGH / ARXK007GLGH / ARXK009GLGH  
 ARXK012GLGH / ARXK014GLGH / ARXK018GLGH  
 ARXK024GLGH

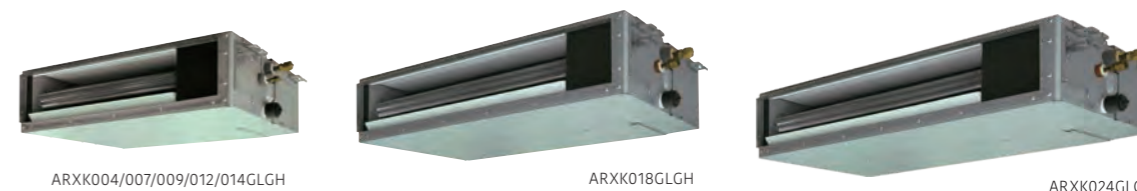

## Specifications

Model name		ARXK004GLGH	ARXK007GLGH	ARXK009GLGH	ARXK012GLGH	ARXK014GLGH	ARXK018GLGH	ARXK024GLGH
Power source		Single phase, 220-240V~, 50Hz						
Capacity	Cooling	1.1	2.2	2.8	3.6	4.5	5.6	7.1
	Heating	1.3	2.8	3.2	4.0	5.0	6.3	8.0
Input power		26	28	28	35	66	73	80
Airflow rate	High	460	460	460	550	760	930	1,160
	Med-High	440	440	440	520	660	840	1,060
	Med	420	420	420	480	560	740	960
	Med-Low	400	400	400	450	490	640	860
	Low	370	370	370	410	410	540	750
Quiet		340	340	340	340	340	470	610
Static pressure range		0 to 30	0 to 30	0 to 30	0 to 30	0 to 50	0 to 50	0 to 50
Standard static pressure		10	10	10	10	15	15	15
Sound pressure level	High	25	26	26	29	34	33	32
	Med-High	24	25	25	27	31	30	30
	Med	23	24	24	26	28	28	28
	Med-Low	22	23	23	25	26	26	27
	Low	21	22	22	24	24	24	25
Quiet		20	21	21	22	22	22	22
Net Dimensions (H x W x D)		mm 198 x 700 x 450	mm 198 x 700 x 450	mm 198 x 700 x 450	mm 198 x 700 x 450	mm 198 x 700 x 450	mm 198 x 900 x 450	mm 198 x 1,100 x 450
Weight		kg 14.5	kg 15.5	kg 15.5	kg 16	kg 16	kg 19	kg 22.5
Connection pipe diameter	Liquid (Flare)	6.35	6.35	6.35	6.35	6.35	6.35	9.52
	Gas (Flare)	9.52	9.52	9.52	12.70	12.70	12.70	15.88
Drain Hose Diameter (I.D./O.D.)		25/32						

Note: Specifications are subject to the following conditions:  
 Cooling: Indoor temperature of 27°CDB/19°CWB, and outdoor temperature of 35°CDB/24°CWB.  
 Heating: Indoor temperature of 20°CDB/(15°CWB), and outdoor temperature of 7°CDB/6°CWB.  
 Pipe length: 7.5 m; Height difference between outdoor unit and indoor unit: 0 m. Voltage: 230 [V].

## Optional parts

\*For more details, please refer to the chapter "Control System List" and "Optional Parts List."

Remote sensor unit: UTY-XSZX21  
 Silver Ion Filter: UTD-HFTA (004-014)  
 UTD-HFTB (018)  
 UTD-HFTC (024)

External power supply unit: UTZ-GXXA, UTZ-GXXC, UTZ-GXXD  
 Auto Louver Grille Kit: UTD-GXTA-W (004-014)  
 UTD-GXTB-W (018)  
 UTD-GXTC-W (024)

## Auto Louver Grille Kit (Optional)

The slim design of the unit provides comfortable cooling and heating air conditioning over a wide area. The optional automatic louver grille, which fits nicely into any interior decor, provides comfortable air conditioning (Optional)

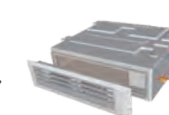

## Dimensions

(Unit: mm)

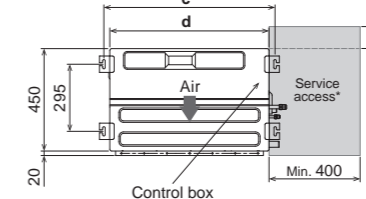
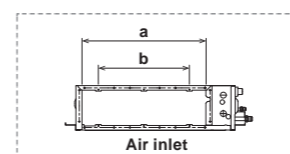

	ARXK 004-014GLGH	ARXK018GLGH	ARXK024GLGH
a	575	775	975
b	P200x2=400	P200x3=600	P200x4=800
c	752	952	1,152
d	700	900	1,100
e	650	850	1,050
f	P100x6=600	P100x8=800	P100x10=1,000

\*The design of the service access depends on the installation method. Refer to the installation manual for more information.

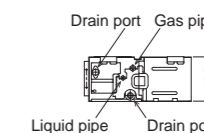
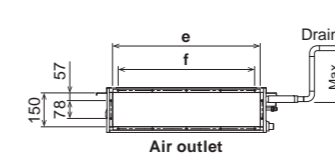
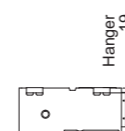

# Slim Duct/ Slim Concealed Floor



## Slim Design

Slim design allows for installation in a tight ceiling space.

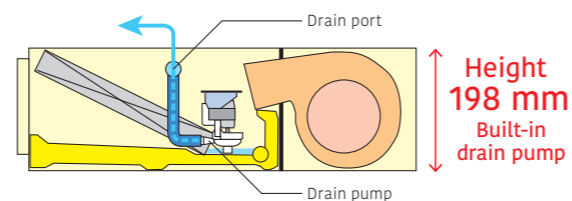

## Air Intake

Air intake direction can be selected to match the installation site.

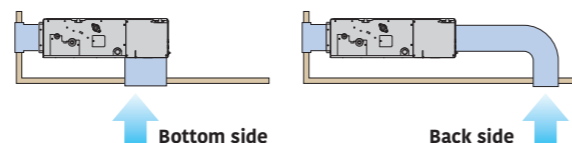

## Flexible Installation

Ceiling concealed

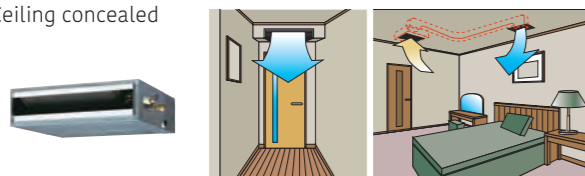

Floor concealed

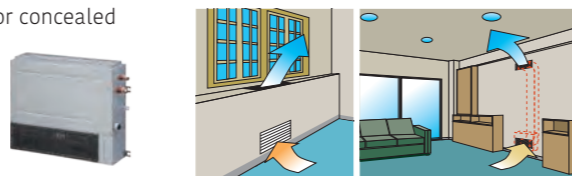

## Wide Range of Static Pressures

The use of a DC fan motor makes it possible to adjust the static pressure between 0 and 90 Pa. The static pressure range can be changed by a remote controller.



Static pressure range  
**0 to 90 Pa**

\*024 model static pressure range is 0 to 50 Pa.

## Filter (Accessory)

ARXD04/007/009/012/014/018 ARXD024

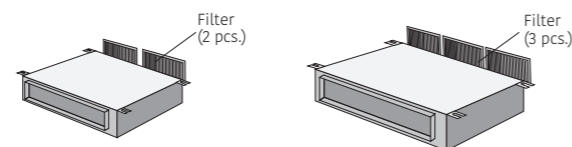

Model: ARXD04GALH / ARXD007GLEH / ARXD009GLEH  
ARXD012GLEH / ARXD014GLEH / ARXD018GLEH  
ARXD024GLEH

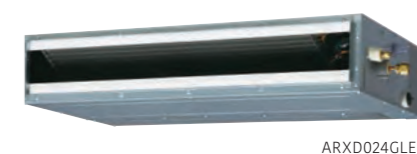
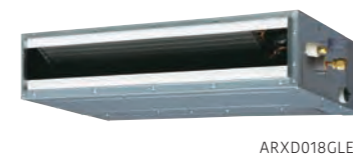

## Specifications

Model name		ARXD04GALH*	ARXD007GLEH	ARXD009GLEH	ARXD012GLEH	ARXD014GLEH	ARXD018GLEH	ARXD024GLEH
Power source		Single phase, 220-240V~, 50Hz						
Capacity	Cooling	1.1	2.2	2.8	3.6	4.5	5.6	7.1
	Heating	1.3	2.8	3.2	4.0	5.0	6.3	8.0
Input power		40	44	50	54	92	83	122
Airflow rate	High	510	550	600	600	800	940	1,330
	Med-High	-	480	510	530	680	820	1,140
	Med	400/470*1	440	460	490	600	730	1,020
	Med-Low	-	410	420	450	520	630	900
	Low	320/440*1	370	370	410	440	540	780
Quiet		-	320	320	340	340	470	610
Static pressure range		0 to 90	0 to 90	0 to 90	0 to 90	0 to 90	0 to 90	0 to 50
Standard static pressure		25	25	25	25	25	25	25
Sound pressure level	High	26	28	29	30	34	34	35
	Med-High	-	26	27	28	32	31	31
	Med	21/25*1	25	25	27	30	29	29
	Med-Low	-	24	24	26	28	27	27
	Low	20/22*1	22	22	24	25	25	24
Quiet		-	21	21	22	22	23	21
Net Dimensions (H × W × D)		mm 198 × 700 × 620	198 × 700 × 620	198 × 700 × 620	198 × 700 × 620	198 × 700 × 620	198 × 900 × 620	198 × 1,100 × 620
Weight		kg 17	17	17	18	18	22	26
Connection pipe diameter	Liquid (Flare)	6.35	6.35	6.35	6.35	6.35	6.35	9.52
	Gas (Flare)	12.70	9.52	9.52	12.70	12.70	12.70	15.88
Drain Hose Diameter (I.D./O.D.)		25/32						

Note: Specifications are subject to the following conditions:  
Cooling: Indoor temperature of 27°CDB/19°CWB, and outdoor temperature of 35°CDB/24°CWB.  
Heating: Indoor temperature of 20°CDB/(15°CWB), and outdoor temperature of 7°CDB/6°CWB.  
Pipe length: 7.5 m; Height difference between outdoor unit and indoor unit: 0 m. Voltage: 230 [V].  
\*1: This value is under cooling operation.  
\*: ARXD04GALH cannot be connected to J-IVS/J-IVJ/IVL/VR-IV series.

## Optional parts

\*For more details, please refer to the chapter "Control System List" and "Optional Parts List."

- Remote sensor unit: UT-Y-XSZXZ1
- Silver Ion Filter: UTD-HFTA (04, 007-014) UTD-HFTB (018) UTD-HFTC (024)
- External power supply unit: UTZ-GXXA, UTZ-GXXC, UTZ-GXXD
- Auto Louver Grille Kit: UTD-GXTA-W (04, 007-014) UTD-GXTB-W (018) UTD-GXTC-W (024)

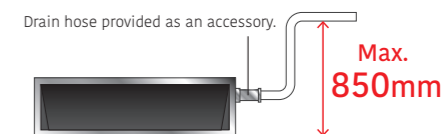

## Dimensions

(Unit: mm)

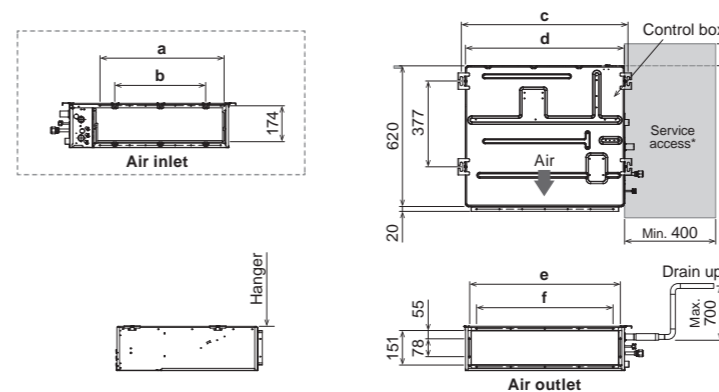

	ARXD04GALH ARXD007-014GLEH	ARXD018GLEH	ARXD024GLEH
a	574	774	974
b	P200x2=400	P200x3=600	P200x4=800
c	734	934	1,134
d	700	900	1,100
e	650	850	1,050
f	P100x6=600	P100x8=800	P100x10=1,000

\*The design of the service access depends on the installation method. Refer to the installation manual for more information.

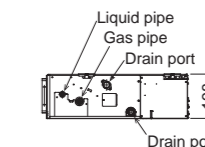

# Duct

Low Static Pressure  
High Efficiency



## Slim & Compact Design

The slim and compact design of the indoor unit, with the control box mounted on the side, allows installation in narrow spaces.

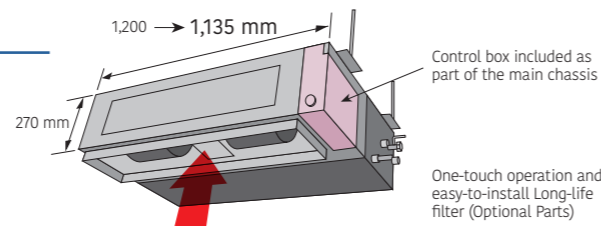

## Easy Maintenance

Structural improvement has been developed by making the bottom panel in two pieces, front and rear. The internal fan casing is also manufactured in two pieces—upper and lower. The motor and fan can be easily accessed and maintained by removing the rear panel and the lower casing with the main chassis remaining in place.

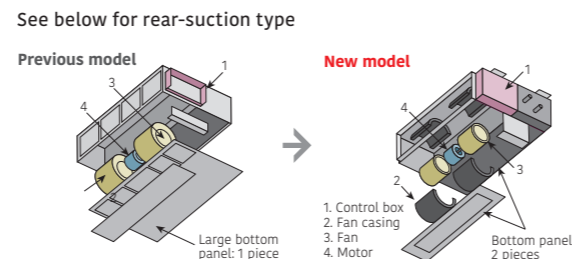

## Installation Styles

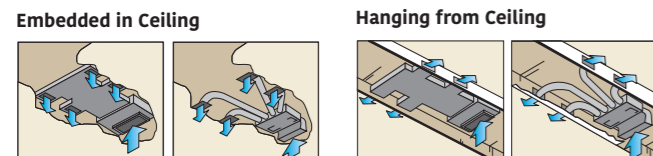

## A Drain Pipe can be Installed on Either The Left or Right Side of The Unit

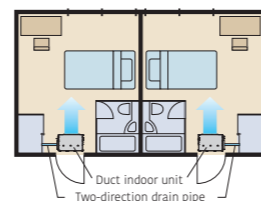

## High-Efficiency DC Fan Motor Achieves Low-Energy Consumption

Improved motor efficiency from previous model.

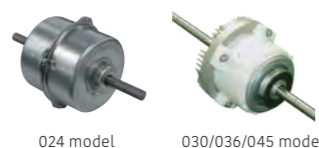

## Wide Range of Static Pressures

Static pressures can be changed in the range of 0 to 80 Pa.

Static pressure range  
**0 to 80 Pa**

Model: ARXP018GLFH / ARXP030GLFH \* Production by order



## Specifications

Model name		ARXP018GLFH	ARXP030GLFH
Power source		Single phase, 220-240V~, 50Hz	
Capacity	Cooling	5.6	9.0
	Heating	6.3	10.0
Input power		128	228
Airflow rate	High	1,540 / 1,440	1,940 / 1,660
	Med-High	1,460 / 1,380	1,810 / 1,580
	Med	1,380 / 1,320	1,680 / 1,510
	Med-Low	1,300 / 1,260	1,550 / 1,440
	Low	1,220 / 1,200	1,420 / 1,370
Quiet		1,150 / 1,150	1,300 / 1,300
Static pressure range		0 to 80	0 to 80
Standard static pressure		40	50
Sound pressure level	High	35 / 34	39 / 36
	Med-High	34 / 32	38 / 35
	Med	32 / 31	36 / 34
	Med-Low	31 / 30	34 / 33
	Low	29 / 29	32 / 31
Quiet		28 / 28	30 / 30
Net Dimensions (H × W × D)		270 × 1,135 × 700	270 × 1,135 × 700
Weight		40	40
Connection pipe diameter	Liquid (Flare)	6.35	9.52
	Gas (Flare)	12.70	15.88
Drain Hose Diameter (I.D./O.D.)		25/32	

Note: Specifications are subject to the following conditions:  
Cooling: Indoor temperature of 27°CDB/19°CWB, and outdoor temperature of 35°CDB/24°CWB.  
Heating: Indoor temperature of 20°CDB/(15°CWB), and outdoor temperature of 7°CDB/6°CWB.  
Pipe length: 7.5 m; Height difference between outdoor unit and indoor unit: 0 m. Voltage: 230 [V].

## Optional parts

\*For more details, please refer to the chapter "Control System List" and "Optional Parts List."

Long-life filter: UTD-LF25NA  
Flange (square): UTD-SF045T  
Flange (round): UTD-RF204

External power supply unit: UTZ-GXXA, UTZ-GXXC, UTZ-GXXD  
Remote sensor unit: UTY-XSZXZ1

Drain pump unit: UTZ-PX1NBA  
Silver Ion Filter: UTD-HFND

## Dimensions

(Unit: mm)

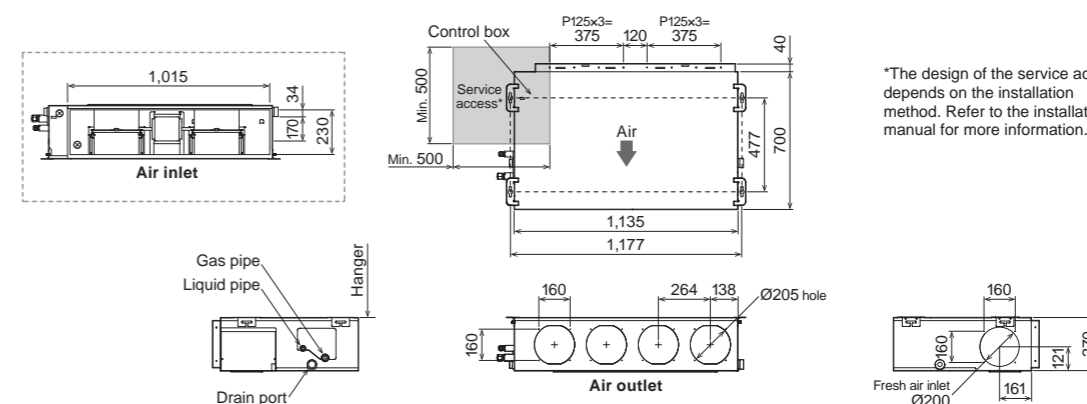

\*The design of the service access depends on the installation method. Refer to the installation manual for more information.

# Duct Medium Static Pressure



Model: ARXA024GLEH / ARXA030GLEH / ARXA036GLEH / ARXA045GLEH

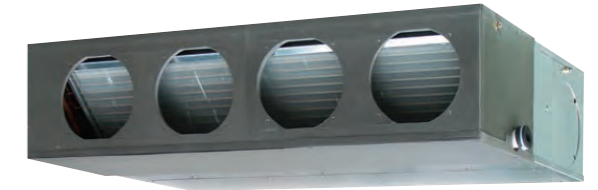

## Slim & Compact Design

The slim and compact design of the indoor unit, with the control box mounted on the side, allows installation in narrow spaces.

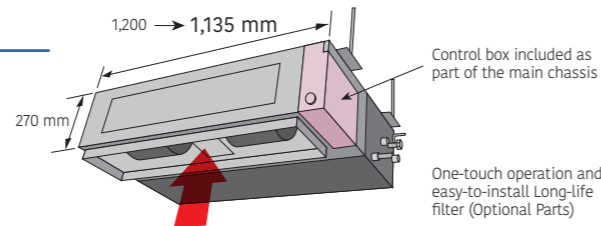

## Easy Maintenance

Structural improvement has been developed by making the bottom panel in two pieces, front and rear. The internal fan casing is also manufactured in two pieces—upper and lower. The motor and fan can be easily accessed and maintained by removing the rear panel and the lower casing with the main chassis remaining in place.

See below for rear-suction type

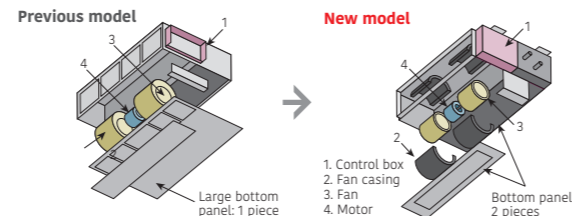

## Installation Styles

Embedded in Ceiling

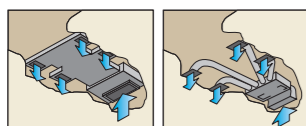

Hanging from Ceiling

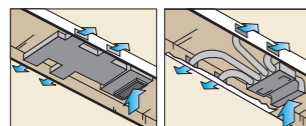

A Drain Pipe can be Installed on Either The Left or Right Side of The Unit

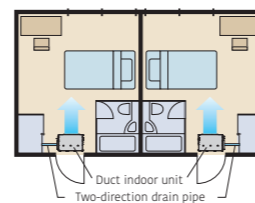

## High-Efficiency DC Fan Motor Achieves Low-Energy Consumption.

Improved motor efficiency from previous model.

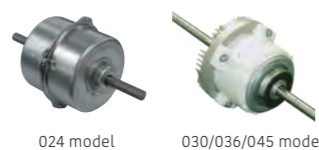

## Wide Range of Static Pressures

Static pressures can be changed in the range of 0 to 150 Pa.

Static pressure range  
**0 to 150 Pa**

## Specifications

Model name		ARXA024GLEH	ARXA030GLEH	ARXA036GLEH	ARXA045GLEH
Power source		Single phase, 220-240V~, 50Hz			
Capacity	Cooling	7.1	9.0	11.2	12.5
	Heating	8.0	10.0	12.5	14.0
Input power		94	108	194	240
Airflow rate	High	1,280	1,410	1,840	1,970
	Med-High	1,180	1,350	1,750	1,910
	Med	1,090	1,280	1,660	1,860
	Med-Low	1,000	1,240	1,600	1,780
	Low	920	1,190	1,530	1,710
	Quiet	840	1,150	1,470	1,640
Static pressure range		0 to 150	0 to 150	0 to 150	0 to 150
Standard static pressure		40	50	50	60
Sound pressure level	High	31	34	37	41
	Med-High	29	33	36	40
	Med	27	32	35	38
	Med-Low	26	31	35	38
	Low	24	30	34	37
	Quiet	23	29	33	36
Net Dimensions (H × W × D)		mm 270 × 1,135 × 700	mm 270 × 1,135 × 700	mm 270 × 1,135 × 700	mm 270 × 1,135 × 700
Weight		kg 36	kg 40	kg 40	kg 40
Connection pipe diameter	Liquid (Flare)	9.52	9.52	9.52	9.52
	Gas (Flare)	15.88	15.88	15.88	15.88
Drain Hose Diameter (I.D./O.D.)		25/32			

Note: Specifications are subject to the following conditions:  
Cooling: Indoor temperature of 27°CDB/19°CWB, and outdoor temperature of 35°CDB/24°CWB.  
Heating: Indoor temperature of 20°CDB/(15°CWB), and outdoor temperature of 7°CDB/6°CWB.  
Pipe length: 7.5 m; Height difference between outdoor unit and indoor unit: 0 m. Voltage: 230 [V].

## Optional parts

\*For more details, please refer to the chapter "Control System List" and "Optional Parts List."

Long-life filter: UTD-LF25NA  
Flange (square): UTD-SF045T  
Flange (round): UTD-RF204

External power supply unit: UTZ-GXXA, UTZ-GXXC, UTZ-GXXD  
Remote sensor unit: UTY-XSZXZ1

Drain pump unit: UTZ-PX1NBA  
Silver Ion Filter: UTD-HFND

## Dimensions

(Unit: mm)

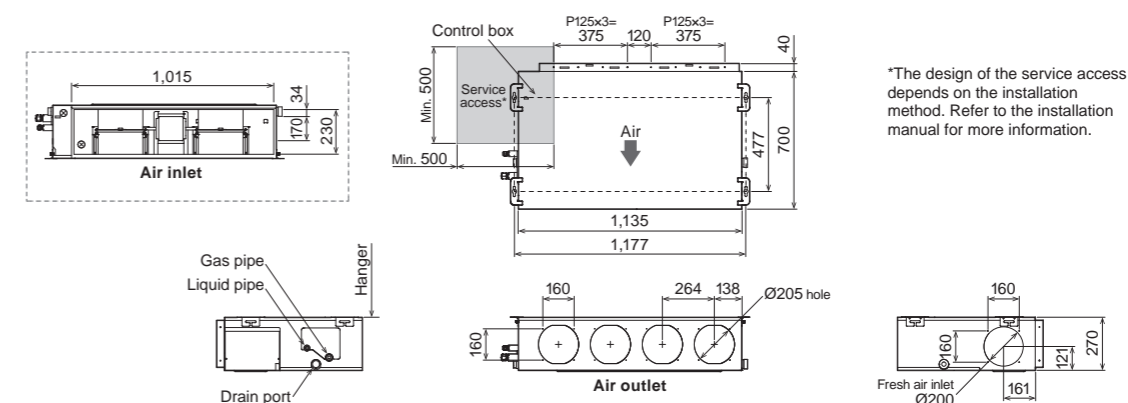

# Duct High Static Pressure



## Static Pressure Mode Selection

The use of a DC fan motor makes it possible to adjust the static pressure between 0 to 200 Pa (ARXC036) / 250 Pa (ARXC045/060) / 300 Pa (ARXC072/090/096)

<div style="border: 1px solid black; padding: 2px; width: 40px; margin: 0 auto;">MAX. 200 Pa <small>(036 type)</small></div> <p style="text-align: center;"><small>(ARXC036/045/060 type)</small></p>	<div style="border: 1px solid black; padding: 2px; width: 40px; margin: 0 auto;">MAX. 250 Pa <small>(045/060 type)</small></div> <p style="text-align: center;"><small>(ARXC045/060 type)</small></p>	<div style="border: 1px solid black; padding: 2px; width: 40px; margin: 0 auto;">MAX. 300 Pa</div> <p style="text-align: center;"><small>(ARXC072/090 type)</small></p>	<div style="border: 1px solid black; padding: 2px; width: 40px; margin: 0 auto;">MAX. 300 Pa</div> <p style="text-align: center;"><small>(ARXC096 type)</small></p>
---	---	---	---

## Easy Installation (Compact & Lightweight)

The indoor unit is designed to be compact and light by reducing the basic chassis size and the overall material weight.

(Unit: mm)

<p style="text-align: center;"><small>(ARXC036/045/060 type)</small></p>	<p style="text-align: center;"><small>(ARXC072/090 type)</small></p>	<p style="text-align: center;"><small>(ARXC096 type)</small></p>
--	--	--

## Low Noise

Models: ARXC036/ARXC045/ARXC060

The corners of the front panel and fan casing of the indoor unit are shaved to reduce air turbulence. The use of a plastic case and fan reduces the noise level generated by the unit.

**ARXC036GTEH:**  
Plastic fan [42 dB(A)]  
\* Model: Material (Actual noise measurement value measured at 100 Pa)

Plastic fan Ø225 mm  
Casing (Plastic)  
Heat exchanger  
500 mm  
400 mm

## High-Efficiency DC Fan Motor Achieves Low Energy Consumption

Improved motor efficiency compared to the previous model.

(ARXC036/045/060 type)      (ARXC072/090/096 type)

Model: ARXC036GTEH / ARXC045GTEH / ARXC060GTEH  
ARXC072GTEH / ARXC090GTEH / ARXC096GTEH



## Specifications

Model name		ARXC036GTEH	ARXC045GTEH	ARXC060GTEH*	ARXC072GTEH*	ARXC090GTEH*	ARXC096GTEH*
Power source		Single phase, 220-240V~, 50Hz					
Capacity	Cooling	11.2	12.5	18.0	22.4	25.0	28.0
	Heating	12.5	14.0	20.0	25.0	28.0	31.5
Input power		207	715	730	681	819	838
Airflow rate	High	1,990	3,500	3,500	3,900	4,300	4,850
	Med	1,680	3,000	3,000	3,300	4,000	4,250
	Low	1,330	2,460	2,460	3,000	3,500	3,600
Static pressure range		0 to 200	100 to 250	100 to 250	0 to 300	0 to 300	0 to 300
Standard static pressure		100	100	100	150	150	150
Sound pressure level	High	42	49	49	47	48	48
	Med	36	45	45	43	46	45
	Low	32	42	42	40	44	42
Net Dimensions (H × W × D)		400 × 1,050 × 500	400 × 1,050 × 500	400 × 1,050 × 500	450 × 1,587 × 700	450 × 1,587 × 700	550 × 1,587 × 700
Weight		40	46	46	84	84	105
Connection pipe diameter	Liquid	9.52 (Flare)	9.52 (Flare)	9.52 (Flare)	9.52 (Flare)	9.52 (Flare)	9.52 (Brazing)
	Gas	15.88 (Flare)	15.88 (Flare)	15.88 (Flare)	19.05 (Flare)	19.05 (Flare)	22.22 (Brazing)
Drain Hose Diameter (I.D./O.D.)		25/32					

Note: Specifications are based on the following conditions:  
Cooling: Indoor temperature of 27°CDB/19°CWB, and outdoor temperature of 35°CDB/24°CWB.  
Heating: Indoor temperature of 20°CDB/(15°CWB), and outdoor temperature of 7°CDB/6°CWB.  
Pipe length: 7.5 m; Height difference between outdoor unit and indoor unit: 0 m. Voltage: 230 [V]  
\*: ARXC060/072/090/096G cannot be connected to J-IV/J-IVS series.

## Optional parts

\*For more details, please refer to the chapter "Control System List" and "Optional Parts List."

Long-life filter: UTD-LF60KA (036/045/060)      External power supply unit: UTZ-GXXA, UTZ-GXXC, UTZ-GXXD      Silver Ion Filter: UTD-HFKB (036/045/060)  
Remote sensor unit: UTY-XSZXZ1

## Dimensions

(Unit: mm)

Models: ARXC036/ARXC045/ARXC060

**Air inlet:** 862 mm width, 32.4 mm height.

**Air outlet:** 851 mm width, 295 mm height.

**Service access:** Control box, Service access\*, Min. 500 mm clearance.

**Other details:** 1,050 mm width, 500 mm height, 35 mm offset, 565 mm depth, 125 mm offset, P120x5=600, Min. 500 mm clearance.

**Bottom view:** 400 mm width, 240 mm offset, P120x2, Safety drain pan.

**Labels:** Liquid pipe, Gas pipe, Main drain pan, Safety drain pan.

Models: ARXC072/ARXC090/ARXC096

**Air inlet:** 1,250 mm width, 65 mm height.

**Air outlet:** 1,200 mm width, 350 mm height.

**Service access:** Control box, Service access\*, Min. 500 mm clearance.

**Other details:** 1,587 mm width, 700 mm height, 1,410 mm offset, 75 mm offset, P5-150x7=1,050, Min. 500 mm clearance.

	ARXC072/090 GTEH	ARXC096 GTEH
a	450	550
b	370	470

**Labels:** Liquid pipe, Gas pipe, Safety Drain port.

# Floor Compact



**Model: [EEV Internal]**  
 AGHA004GCGH / AGHA007GCGH / AGHA009GCGH  
 AGHA012GCGH / AGHA014GCGH

**[EEV External]**  
 AGHE004GCEH / AGHE007GCEH / AGHE009GCEH  
 AGHE012GCEH / AGHE014GCEH

### Specifications

Model name	AGHA004GCGH	AGHA007GCGH	AGHA009GCGH	AGHA012GCGH	AGHA014GCGH	AGHE004GCEH	AGHE007GCEH	AGHE009GCEH	AGHE012GCEH	AGHE014GCEH		
Power source	Single phase, 220-240V~, 50Hz					Single phase, 220-240V~, 50Hz						
Capacity	Cooling	1.1	2.2	2.8	3.6	4.0	1.1	2.2	2.8	3.6	4.0	
	Heating	1.3	2.8	3.2	4.0	4.5	1.3	2.8	3.2	4.0	4.5	
Input power	kW		W		W		W		W		W	
Airflow rate	High	380/430	470	500	590	670	380/430	470	500	590	670	
	Med-High	350	420	450	520	590	350	420	450	520	590	
	Med	320	390	400	470	520	320	390	400	470	520	
	Med-Low	310	360	360	420	450	310	360	360	420	450	
	Low	280	330	330	390	390	280	330	330	390	390	
Sound pressure level	High	210	270	270	340	340	210	270	270	340	340	
	Med-High	35/36	37	38	42	46	35/36	37	38	42	46	
	Med	33	35	36	39	42	33	35	36	39	42	
	Med-Low	31	33	34	37	39	31	33	34	37	39	
	Low	30	31	31	35	36	30	31	31	35	36	
Quiet	28	29	29	33	33	28	29	29	33	33		
Quiet	22	22	22	30	30	22	22	22	30	30		
Net Dimensions (H × W × D)	mm 600 × 740 × 200					mm 600 × 740 × 200						
Weight	kg 15.0					kg 14.5						
Connection pipe diameter	Liquid (Flare)	6.35	6.35	6.35	6.35	6.35	6.35	6.35	6.35	6.35		
	Gas (Flare)	9.52	9.52	9.52	12.70	12.70	9.52	9.52	9.52	12.70		
Drain Hose Diameter (I.D./O.D.)	mm 13.8/15.8 to16.7					mm 13.8/15.8 to16.7						
EV kit (optional)						UTR-EV09XB		UTR-EV14XB				

### 2-Fan and Wide Airflow

A 2-fan individual vertical airflow cools or warms the entire room comfortably.

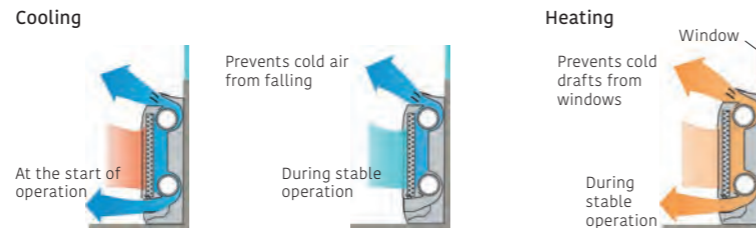

### Flexible and Easy Installation

The compact and whole-surface suction design provides flexible installation options, including floor-standing, embedded, partially embedded, and wall-mounted installation to match the room layout.

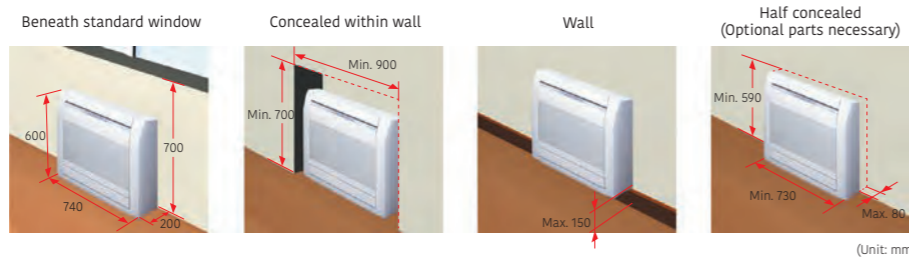

### Quiet Operation

6-fan speed control for quiet operation (via 2-wire controller)

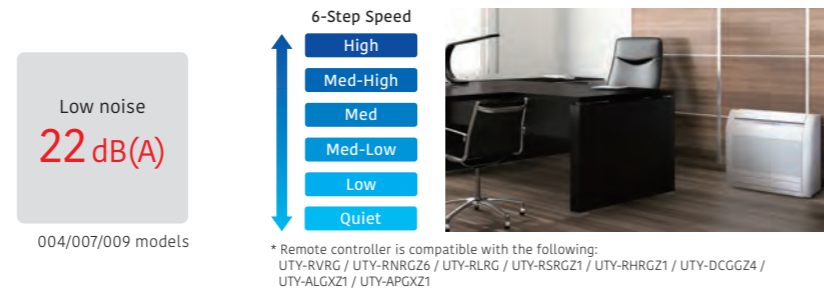

### Flexible Pipe Connection Enables Draining and Piping in 6 Directions

The drain hose and pipe can be connected to the unit in the right, left, straight in depth, or downward direction.

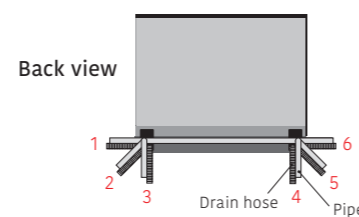

### Optional parts

\*For more details, please refer to the chapter "Control System List" and "Optional Parts List."

- Partially concealing kit: UTR-STA
- External power supply unit: UTZ-GXXA, UTZ-GXXC, UTZ-GXXD
- Silver Ion Filter: UTR-FA03-5
- EV kit: UTR-EV09XB/UTR-EV09XC (004-009), UTR-EV14XB/UTR-EV14XC (012-014) (For EEV external model)

### Dimensions

(Unit: mm)

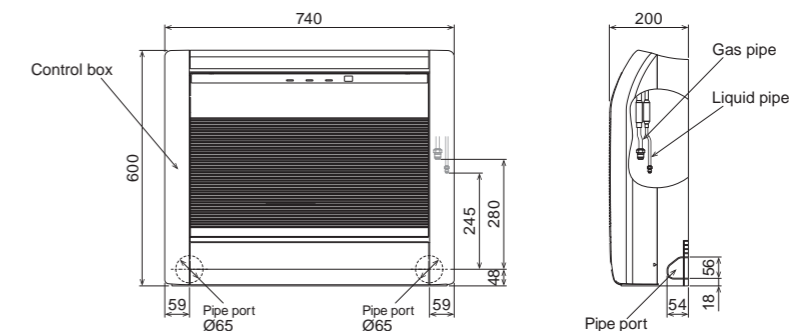

# Floor / Ceiling

Standard



Model: ABHA012GTEH / ABHA014GTEH / ABHA018GTEH / ABHA024GTEH



Floor standing

### Specifications

Model name		ABHA012GTEH	ABHA014GTEH	ABHA018GTEH	ABHA024GTEH
Power source		Single phase, 220-240V~, 50Hz			
Capacity	Cooling	3.6	4.5	5.6	7.1
	Heating	4.0	5.0	6.3	8.0
Input power		30	42	74	99
Airflow rate	High	660	780	1,000	1,000
	Med-High	620	740	910	930
	Med	580	690	830	870
	Med-Low	550	640	750	800
	Low	520	600	660	740
	Quiet	490	550	580	680
Sound pressure level	High	36	40	46	47
	Med-High	34	39	44	45
	Med	33	38	42	43
	Med-Low	31	36	40	41
	Low	29	35	37	39
	Quiet	28	34	35	37
Net Dimensions (H × W × D)		mm 199 × 990 × 655	mm 199 × 990 × 655	mm 199 × 990 × 655	mm 199 × 990 × 655
Weight		kg 25	kg 26	kg 26	kg 27
Connection pipe diameter	Liquid (Flare)	6.35	6.35	6.35	9.52
	Gas (Flare)	12.70	12.70	12.70	15.88
Drain Hose Diameter (I.D./O.D.)		25/32			

Note: Specifications are subject to the following conditions:  
 Cooling: Indoor temperature of 27°CDB/19°CWB, and outdoor temperature of 35°CDB/24°CWB.  
 Heating: Indoor temperature of 20°CDB/(15°CWB), and outdoor temperature of 7°CDB/6°CWB.  
 Pipe length: 7.5 m; Height difference between outdoor unit and indoor unit: 0 m. Voltage: 230 [V]

### Flexible Installation

#### Example of floor standing installation

Floor standing console with the back against the wall



#### Example of ceiling installation

Under ceiling



### Double Auto Swing

The combination of left and right and vertical swings enables 3-dimensional control of the airflow direction.

RIGHT and LEFT SWING

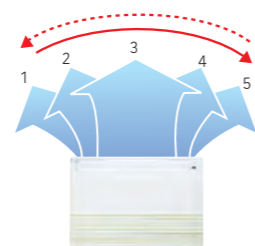

UP and DOWN SWING

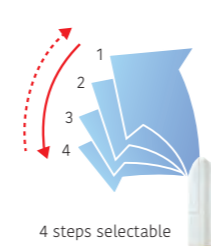

4 steps selectable

### High-Power DC Fan Motor

- High power
- Wide rotation range
- High-efficiency



### Compact Design

Symmetrical, slim and compact design.



(Unit: mm)

### Optional parts

\*For more details, please refer to the chapter "Control System List" and "Optional Parts List."

External power supply unit: UTZ-GXXA, UTZ-GXXC, UTZ-GXXD  
 Remote sensor unit: UTY-XSZXZ1

### Dimensions

(Unit: mm)

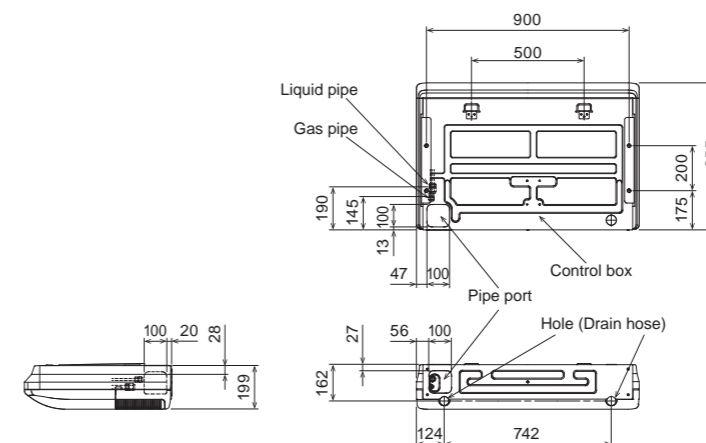

# Ceiling



Model: ABHA030GTEH / ABHA036GTEH / ABHA045GTEH / ABHA054GTEH



### Specifications

Model name		ABHA030GTEH	ABHA036GTEH	ABHA045GTEH	ABHA054GTEH
Power source		Single phase, 220-240V~, 50Hz			
Capacity	Cooling	9.0	11.2	12.5	14.0
	Heating	10.0	12.5	14.0	16.0
Input power		66	85	131	180
Airflow rate	High	1,630	1,690	2,010	2,270
	Med-High	1,520	1,560	1,840	2,070
	Med	1,420	1,450	1,690	1,860
	Med-Low	1,320	1,360	1,530	1,660
	Low	1,220	1,270	1,380	1,470
	Quiet	1,140	1,170	1,230	1,280
Sound pressure level	High	42	45	48	51
	Med-High	40	41	46	49
	Med	39	39	45	46
	Med-Low	37	38	41	43
	Low	35	36	38	40
	Quiet	33	34	35	36
Net Dimensions (H × W × D)		mm 240 × 1,660 × 700	240 × 1,660 × 700	240 × 1,660 × 700	240 × 1,660 × 700
Weight		kg 46	48	48	48
Connection pipe diameter	Liquid (Flare)	9.52	9.52	9.52	9.52
	Gas (Flare)	15.88	15.88	15.88	15.88
Drain Hose Diameter (I.D./O.D.)		25/32			

Note: Specifications are subject to the following conditions:  
 Cooling: Indoor temperature of 27°CDB/19°CWB, and outdoor temperature of 35°CDB/24°CWB.  
 Heating: Indoor temperature of 20°CDB/(15°CWB), and outdoor temperature of 7°CDB/6°CWB.  
 Pipe length: 7.5 m; Height difference between outdoor unit and indoor unit: 0 m. Voltage: 230 [V]

### Installation

**Open**

General installation with indoor unit installed on the ceiling

**Concealed**

Installation with indoor unit embedded into the ceiling

**Wall-mounted type** (Locally Available)

Wall-mounting brackets are used to mount the indoor unit on the wall. (Locally available)  
This type of installation is used when the ceiling space is insufficient.

### Double Auto Swing and Wide Airflow

Auto airflow direction and auto swing

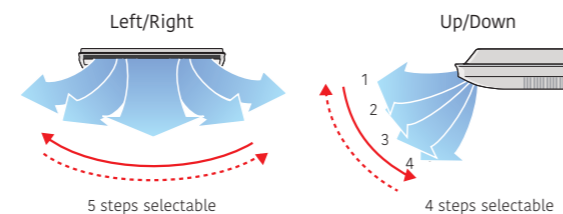

### High-Power DC Fan Motor

- High power
- Wide rotation range
- High-efficiency

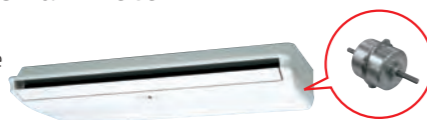

### Long Airflow

Long airflow provides comfort in every corner of a large room.

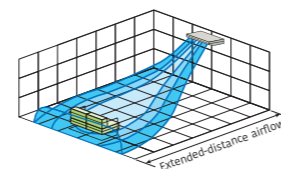

### Fresh Air Intake

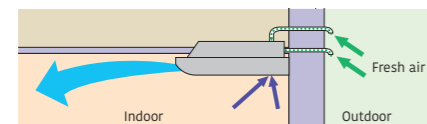

### Slim & Compact Design



### Optional parts

- \*For more details, please refer to the chapter "Control System List" and "Optional Parts List."
- Drain pump unit: UTR-DPB24T
  - Flange: UTD-RF204
  - External power supply unit: UTZ-GXXA, UTZ-GXXC, UTZ-GXXD
  - Remote sensor unit: UTY-XSZXZ1

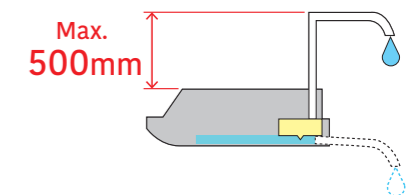

### Dimensions

(Unit: mm)

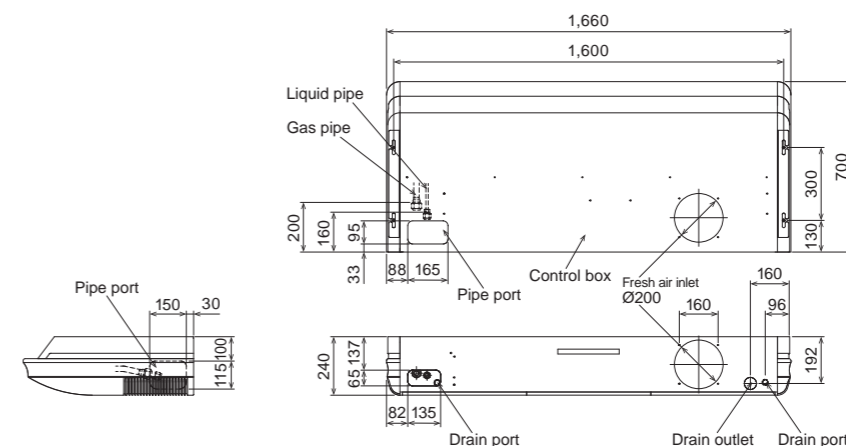

# Wall-Mounted

EEV internal / EEV external



## Highly-Efficiency, Compact Design

The 004-014 models share the same design. The high-density and large heat exchanger achieves a highly-efficiency and compact design. The compact body blends in well with conference rooms and offices, providing comfortable air conditioning.

High-density heat exchanger



**Slim tube design: 5 mm**

Greater heat-exchanging capacity is achieved through the use of a high-density heat exchanger and a sub-heat exchanger.

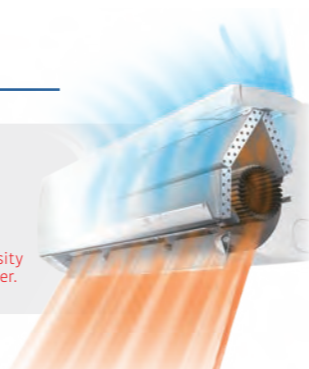

## More Comfortable Airflow

The unique power diffuser provides comfortable air conditioning.

### Heating

The vertical airflow provides powerful floor-level heating.

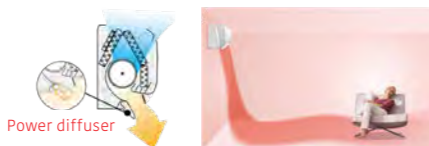

### Cooling

The left/right airflow avoids blowing cool air directly at the occupants in a room.



## Quiet Operation & 6-Step Fan Speed Control

The airflow pattern achieves significant noise reduction. Multistep airflow adjustment to suit the environment

Quiet mode  
**37 dB(A)**

004/007/009 models

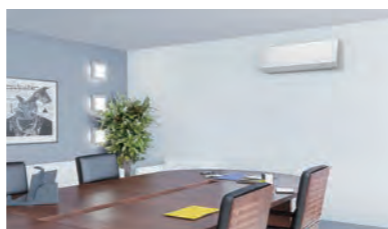
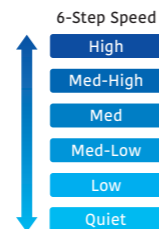

\* Remote controller is compatible with the following:  
UTY-RVRG / UTY-RNRGZ6 / UTY-RLRG / UTY-RSRGZ1 / UTY-RHRGZ1 / UTY-DCGGZ4 / UTY-ALGXZ1 / UTY-APGXZ1

## The Occupancy Sensor Contributes to Further Energy Savings.

Energy saving operation starts automatically by detecting the motion of a person. Two modes of save operation mode and stop mode can be selected.

\* If you want to use the Occupancy sensor control' function, you need an setting device that can set the Occupancy sensor control' function. For example: Wired RC (Touch panel).

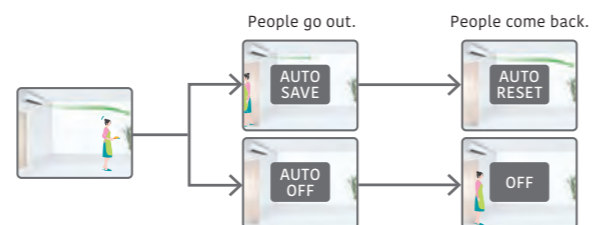

**Model: [EEV Internal]**  
ASHA004GCGH / ASHA007GCGH / ASHA009GCGH  
ASHA012GCGH / ASHA014GCGH

**[EEV External]**  
ASHE004GCEH / ASHE007GCEH / ASHE009GCEH  
ASHE012GCEH / ASHE014GCEH



## Specifications

Model name	ASHA004GCGH	ASHA007GCGH	ASHA009GCGH	ASHA012GCGH	ASHA014GCGH	ASHE004GCEH	ASHE007GCEH	ASHE009GCEH	ASHE012GCEH	ASHE014GCEH	
Power source	Single phase, 220-240V~, 50Hz					Single phase, 220-240V~, 50Hz					
Capacity	Cooling	1.1	2.2	2.8	3.6	4.0	1.1	2.2	2.8	3.6	4.0
	Heating	1.3	2.8	3.2	4.0	4.5	1.3	2.8	3.2	4.0	4.5
Input power	W										
Airflow rate	High	450	550	610	690	800	450	550	610	690	800
	Med-High	430	510	560	610	740	430	510	560	610	740
	Med	400	470	510	560	680	400	470	510	560	680
	Med-Low	380	410	440	530	610	380	410	440	530	610
	Low	360	360	360	470	550	360	360	360	470	550
	Quiet	310	310	310	330	330	310	310	310	330	330
Sound pressure level	High	31	34	37	40	44	31	35	43	40	44
	Med-High	30	32	35	37	42	30	32	38	37	42
	Med	28	30	32	35	40	28	30	34	35	40
	Med-Low	27	28	29	33	37	27	27	29	33	37
	Low	26	26	26	30	34	26	24	24	30	34
	Quiet	22	22	22	24	24	22	22	22	24	24
Net Dimensions (H x W x D)	mm 268 x 840 x 203					mm 268 x 840 x 203					
Weight	kg 8.0, 8.5, 8.5, 8.5, 8.5, 8.0, 8.5, 8.5, 8.5, 8.5										
Connection pipe diameter	Liquid (Flare)	mm 6.35, 6.35, 6.35, 6.35, 6.35, 6.35, 6.35, 6.35, 6.35, 6.35, 6.35									
	Gas (Flare)	mm 9.52, 9.52, 9.52, 12.70, 12.70, 9.52, 9.52, 9.52, 12.70, 12.70									
Drain Hose Diameter (I.D./O.D.)	mm 13.8/15.8 to16.7					mm 13.8/15.8 to16.7					
EV kit (optional)	-					UTR-EV09XB		UTR-EV14XB			

Note: Specifications are subject to the following conditions:  
Cooling: Indoor temperature of 27°CDB/19°CWB, and outdoor temperature of 35°CDB/24°CWB.  
Heating: Indoor temperature of 20°CDB/(15°CWB), and outdoor temperature of 7°CDB/6°CWB.  
Pipe length: 7.5 m; Height difference between outdoor unit and indoor unit: 0 m. Voltage: 230 [V]  
When connecting ASH\*004G\*\*H, ASH\*007G\*\*H, ASH\*009G\*\*H to an outdoor unit other than the outdoor unit of the J-IVL series, the gas pipe diameter should be Ø12.70 mm.

## Optional parts

\*For more details, please refer to the chapter "Control System List" and "Optional Parts List."

- External power supply unit: UTZ-GXXA, UTZ-GXXC, UTZ-GXXD
- Silver Ion Filter: UTR-FA16-5
- Remote sensor kit: UTY-XSZXZ1
- EV kit: UTR-EV09XB/UTR-EV09XC (004-009), UTR-EV14XB/UTR-EV14XC (012-014)  
(For EEV external model)

## Dimensions

(Unit: mm)

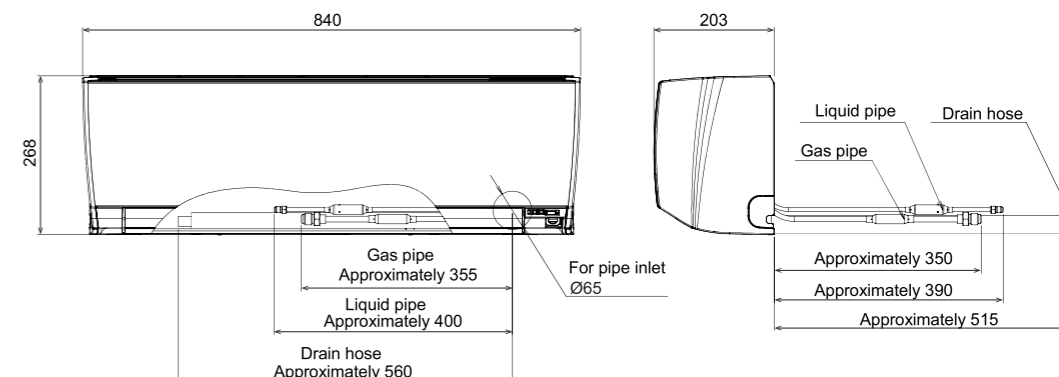

# Wall-Mounted



## Powerful & Comfort Airflow

### Powerful Airflow

(ASHA030GTEH)

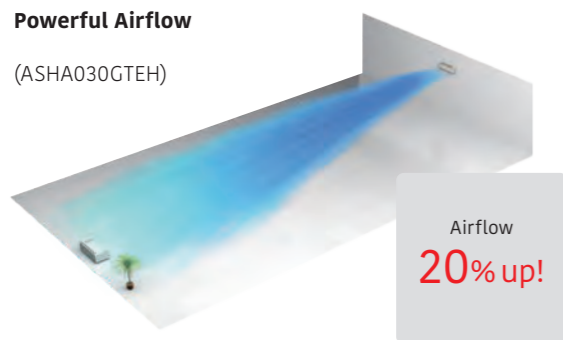

### Power diffuser

(ASHA18/24GBCH)

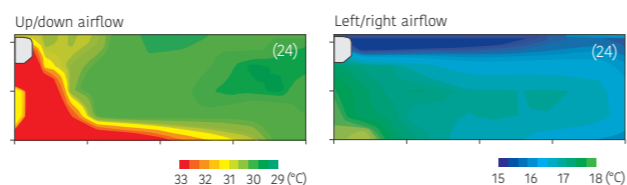

## The Occupancy Sensor Contributes to Further Energy Savings (ASHA030/034GTEH only)

Energy saving operation starts automatically by detecting the motion of a person. Two modes of save operation mode and stop mode can be selected.

\* If you want to use the Occupancy sensor control' function, you need an setting device that can set the Occupancy sensor control' function. For example: Wired RC (Touch panel).

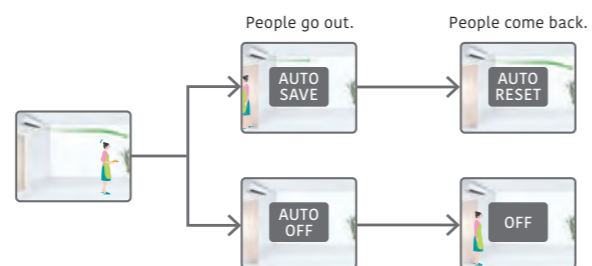

## 6-Step Fan Speed Control for Quiet Operation

The airflow pattern achieves significant noise reduction. A 6-step sound level setting allows for multiple-step quiet operations.

Quiet mode  
**33 dB(A)**

030/034 models

6-Step Speed

- High
- Med-High
- Med
- Med-Low
- Low
- Quiet

\* Remote controller is compatible with the following:  
 UTY-RVRG / UTY-RNRGZ6 / UTY-RLRG / UTY-RSRGZ1 / UTY-RHRGZ1 / UTY-DCGGZ6 / UTY-ALGXZ1 / UTY-APGXZ1

Model: ASHA18GBCH / ASHA24GBCH  
 ASHA030GTEH / ASHA034GTEH



## Specifications

Model name		ASHA18GBCH	ASHA24GBCH	ASHA030GTEH	ASHA034GTEH
Power source		Single phase, 220-240V~, 50Hz			
Capacity	Cooling	5.6	7.1	9.0	10.0
	Heating	6.3	8.0	10.0	11.2
Input power		32	60	74	103
Airflow rate	High	840	1,100	1,440	1,620/1,520
	Med-High	-	-	1,200	1,300
	Med	770	910	1,050	1,120
	Med-Low	-	-	940	980
	Low	690	730	890	890
	Quiet	-	-	700	700
Sound pressure level	High	41	48	53	55/54
	Med-High	-	-	49	51
	Med	39	43	45	47
	Med-Low	-	-	42	43
	Low	35	35	39	39
	Quiet	-	-	33	33
Net Dimensions (H x W x D)		mm 320 x 998 x 238	320 x 998 x 238	340 x 1,150 x 280	340 x 1,150 x 280
Weight		kg 15	15	18	18
Connection pipe diameter	Liquid (Flare)	6.35	9.52	9.52	9.52
	Gas (Flare)	12.70	15.88	15.88	15.88
Drain Hose Diameter (I.D./O.D.)		12/16		13.8/15.8 to16.7	

Note: Specifications are subject to the following conditions:  
 Cooling: Indoor temperature of 27°CDB/19°CWB, and outdoor temperature of 35°CDB/24°CWB.  
 Heating: Indoor temperature of 20°CDB/(15°CWB), and outdoor temperature of 7°CDB/6°CWB.  
 Pipe length: 7.5 m; Height difference between outdoor unit and indoor unit: 0 m. Voltage: 230 [V].  
 When connecting ASHA18GBCH to an outdoor unit other than the outdoor unit of the J-IVL series, the pipe diameter should be Ø9.52/Ø15.88 mm (Liquid/Gas).

## Optional parts

\*For more details, please refer to the chapter "Control System List" and "Optional Parts List."

External power supply unit: UTZ-GXXA, UTZ-GXXC, UTZ-GXXD  
 Remote sensor kit: UTY-XSZXZ1  
 Silver Ion Filter: UTR-FA13-3

## Dimensions

(Unit: mm)

Models: ASHA18/ASHA24

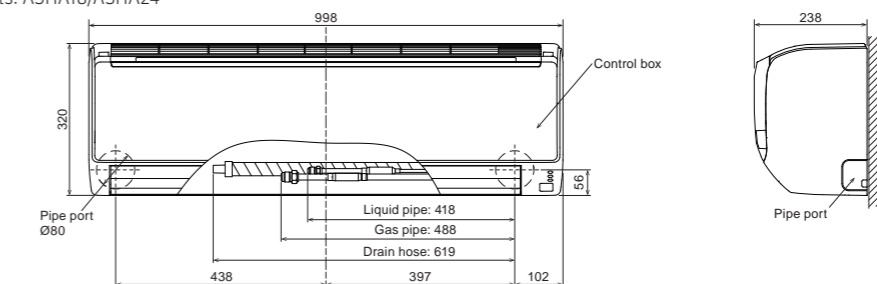

Models: ASHA030/ASHA034

